

Ergebnis: **414.8** (396)
 Serien: 102.0 103.7 105.8 103.3
 Zaehler: 36 4 0 0 0 0 0 0 0 0
 Innenzehner: 33
 weiteste: 370 (8), 287 (33), 276 (4)
 beste Teiler 40.6 (22.) 40.7 (23.) 49.2 (21.)
 Trefferlage 0.04 mm rechts, 0.18 mm hoch
 Streuwert 1.16, horizontal: 1.22, vertikal: 1.10

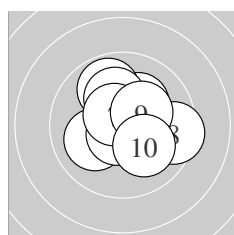

Serie 1:
 10.2 * 10.5 * 10.1 ↙ 9.8 ↗ 10.7 *
 10.2 * 10.6 * 9.5 → 10.3 * 10.1 ↘
 beste Teiler 74.4 (5.) 96.8 (7.) 123.7 (2.)
 Trefferlage 0.43 mm rechts, 0.38 mm hoch
 Streuwert 1.51, horizontal: 1.64, vertikal: 1.36

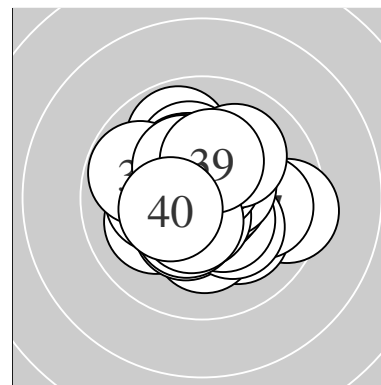
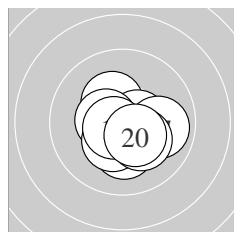

Serie 2:
 10.2 * 10.6 * 10.3 * 10.5 * 10.5 *
 10.4 * 9.9 → 10.7 * 10.2 * 10.4 *
 beste Teiler 75.1 (18.) 90.1 (12.) 106.2 (14.)
 Trefferlage 0.23 mm rechts, 0.54 mm tief
 Streuwert 1.06, horizontal: 1.19, vertikal: 0.93

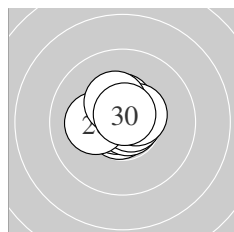

Serie 3:
 10.8 * 10.8 * 10.8 * 10.5 * 10.5 *
 10.7 * 10.5 * 10.2 * 10.3 * 10.7 *
 beste Teiler 40.6 (22.) 40.7 (23.) 49.2 (21.)
 Trefferlage 0.15 mm links, 0.42 mm hoch
 Streuwert 0.73, horizontal: 0.80, vertikal: 0.66

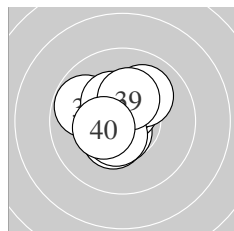

Serie 4:
 10.4 * 10.6 * 9.8 ↖ 10.6 * 10.3 *
 10.4 * 10.0 ↗ 10.5 * 10.3 * 10.4 *
 beste Teiler 79.0 (32.) 85.4 (34.) 110.0 (38.)
 Trefferlage 0.35 mm links, 0.45 mm hoch
 Streuwert 1.15, horizontal: 1.13, vertikal: 1.18

Unterschrift des Schuetzen

Meyton Elektronik

Ergebnis: **413.7** (395)
 Serien: 102.5 103.5 103.0 104.7
 Zaehler: 35 5 0 0 0 0 0 0 0 0
 Innenzehner: 30
 weiteste: 374 (6), 367 (39), 301 (24)
 beste Teiler 37.4 (31.) 39.0 (32.) 51.6 (27.)
 Trefferlage 0.17 mm links, 0.14 mm hoch
 Streuwert 1.24, horizontal: 1.44, vertikal: 1.01

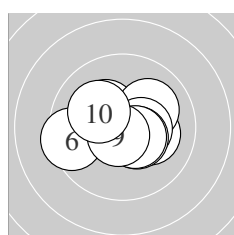
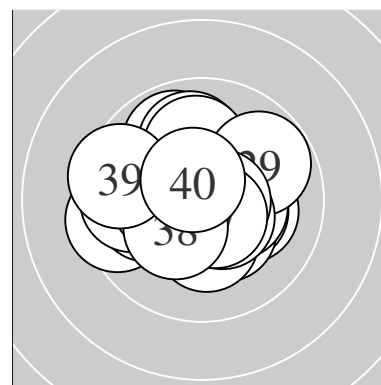

Serie 1:
 10.3 * 10.2 * 10.3 * 10.1 ↗ 10.4 *
 9.5 ← 10.4 * 10.5 * 10.7 * 10.1 ↖
 beste Teiler 64.8 (9.) 114.6 (8.) 127.4 (7.)
 Trefferlage 0.13 mm links, 0.06 mm hoch
 Streuwert 1.43, horizontal: 1.83, vertikal: 0.87

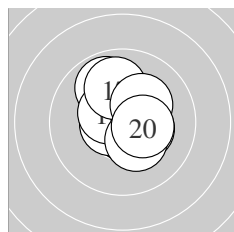

Serie 2:
 10.7 * 10.3 * 9.9 ↗ 10.6 * 10.6 *
 10.5 * 10.0 ↑ 10.2 * 10.3 * 10.4 *
 beste Teiler 65.9 (11.) 85.5 (15.) 89.8 (14.)
 Trefferlage 0.28 mm rechts, 0.38 mm hoch
 Streuwert 1.18, horizontal: 1.07, vertikal: 1.29

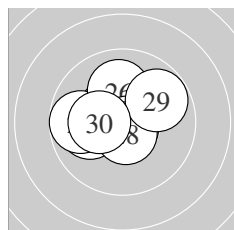

Serie 3:
 10.7 * 10.5 * 10.0 ← 9.7 ← 10.6 *
 10.1 ↑ 10.7 * 10.6 * 9.8 ↗ 10.3 *
 beste Teiler 51.6 (27.) 61.3 (21.) 77.0 (25.)
 Trefferlage 0.54 mm links, 0.30 mm hoch
 Streuwert 1.30, horizontal: 1.55, vertikal: 0.99

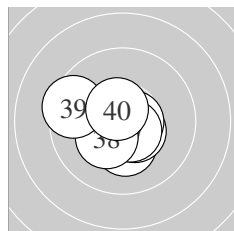

Serie 4:
 10.8 * 10.8 * 10.3 * 10.6 * 10.5 *
 10.7 * 10.6 * 10.3 * 9.5 ↖ 10.6 *
 beste Teiler 37.4 (31.) 39.0 (32.) 71.2 (36.)
 Trefferlage 0.32 mm links, 0.19 mm tief
 Streuwert 1.11, horizontal: 1.30, vertikal: 0.87

Unterschrift des Schuetzen

Meyton Elektronik

Ergebnis: **413.6** (396)

Serien: 102.7 103.2 103.1 104.6

Zaehler: 36 4 0 0 0 0 0 0 0 0

Innenzehner: 32

weiteste: 320 (6), 305 (1), 299 (17)

beste Teiler 40.2 (30.) 45.6 (29.) 53.5 (37.)

Trefferlage 0.07 mm rechts, 0.08 mm tief

Streuwert 1.21, horizontal: 1.16, vertikal: 1.27

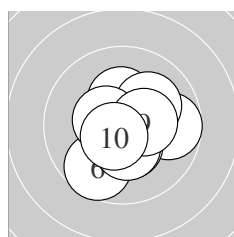
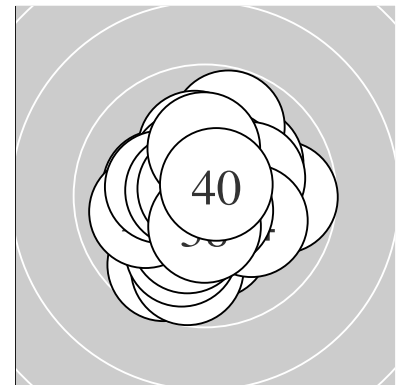

Serie 1:

9.7 →	10.3 *	10.1 ↗	10.6 *	10.4 *
9.7 ↘	10.4 *	10.5 *	10.4 *	10.6 *

beste Teiler 86.6 (4.) 93.4 (10.) 115.7 (8.)

Trefferlage 0.41 mm rechts, 0.33 mm tief

Streuwert 1.35, horizontal: 1.39, vertikal: 1.32

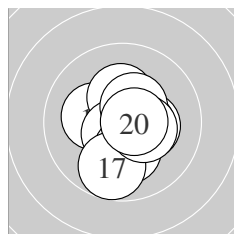

Serie 2:

10.2 *	10.3 *	10.3 *	10.6 *	10.4 *
10.2 *	9.8 ↓	10.4 *	10.4 *	10.6 *

beste Teiler 77.0 (20.) 90.6 (14.) 127.6 (18.)

Trefferlage 0.29 mm rechts, 0.33 mm tief

Streuwert 1.21, horizontal: 1.09, vertikal: 1.32

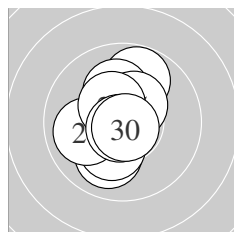

Serie 3:

9.8 ↗	10.0 ↘	10.2 *	10.2 *	10.4 *
10.5 *	10.0 ←	10.4 *	10.8 *	10.8 *

beste Teiler 40.2 (30.) 45.6 (29.) 104.4 (26.)

Trefferlage 0.45 mm links, 0.20 mm hoch

Streuwert 1.29, horizontal: 0.96, vertikal: 1.55

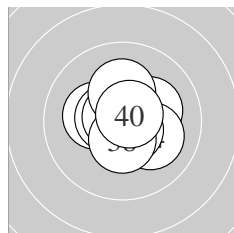

Serie 4:

10.7 *	10.2 *	10.2 *	10.1 ↘	10.6 *
10.7 *	10.7 *	10.5 *	10.2 *	10.7 *

beste Teiler 53.5 (37.) 64.3 (40.) 68.6 (31.)

Trefferlage 0.06 mm rechts, 0.13 mm hoch

Streuwert 1.02, horizontal: 1.13, vertikal: 0.90

Unterschrift des Schuetzen

Meyton Elektronik

Ergebnis: **415.4** (394)
 Serien: 104.5 103.6 104.9 102.4
 Zaehler: 34 6 0 0 0 0 0 0 0 0
 Innenzehner: 34
 weiteste: 390 (1), 342 (37), 325 (39)
 beste Teiler 36.0 (2.) 55.1 (29.) 66.2 (40.)
 Trefferlage 0.35 mm rechts, 0.23 mm hoch
 Streuwert 1.15, horizontal: 1.35, vertikal: 0.91

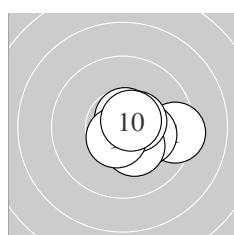
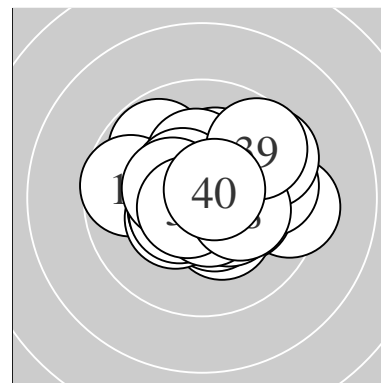

Serie 1:
 9.4 → 10.8 * 10.7 * 10.7 * 10.2 *
 10.7 * 10.3 * 10.5 * 10.6 * 10.6 *
 beste Teiler 36.0 (2.) 67.8 (6.) 69.3 (4.)
 Trefferlage 0.94 mm rechts, 0.20 mm tief
 Streuwert 0.95, horizontal: 1.18, vertikal: 0.63

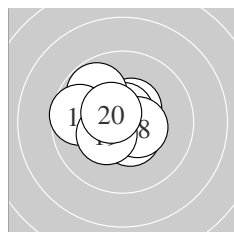

Serie 2:
 10.6 * 10.5 * 10.5 * 10.4 * 10.7 *
 9.8 ↘ 9.7 ← 10.5 * 10.4 * 10.5 *
 beste Teiler 68.2 (15.) 77.5 (11.) 108.7 (20.)
 Trefferlage 0.49 mm links, 0.40 mm hoch
 Streuwert 1.17, horizontal: 1.35, vertikal: 0.95

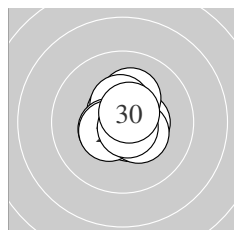

Serie 3:
 10.4 * 10.6 * 10.2 * 10.4 * 10.5 *
 10.6 * 10.5 * 10.4 * 10.7 * 10.6 *
 beste Teiler 55.1 (29.) 80.2 (22.) 84.0 (26.)
 Trefferlage 0.17 mm rechts, 0.13 mm hoch
 Streuwert 0.86, horizontal: 0.81, vertikal: 0.90

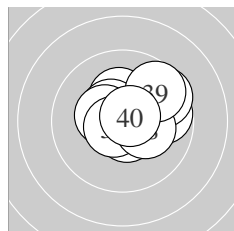

Serie 4:
 10.6 * 10.3 * 10.5 * 9.8 → 10.4 *
 10.6 * 9.6 ↗ 10.2 * 9.7 ↗ 10.7 *
 beste Teiler 66.2 (40.) 76.5 (36.) 86.1 (31.)
 Trefferlage 0.77 mm rechts, 0.60 mm hoch
 Streuwert 1.35, horizontal: 1.61, vertikal: 1.03

Unterschrift des Schuetzen

Meyton Elektronik

Ergebnis: **410.0** (391)
 Serien: 103.4 102.8 102.7 101.1
 Zaehler: 31 9 0 0 0 0 0 0 0 0
 Innenzehner: 26
 weiteste: 316 (40), 311 (22), 305 (39)
 beste Teiler 26.0 (24.) 67.0 (1.) 69.5 (10.)
 Trefferlage 0.18 mm links, 0.36 mm tief
 Streuwert 1.34, horizontal: 1.48, vertikal: 1.20

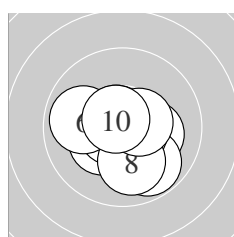
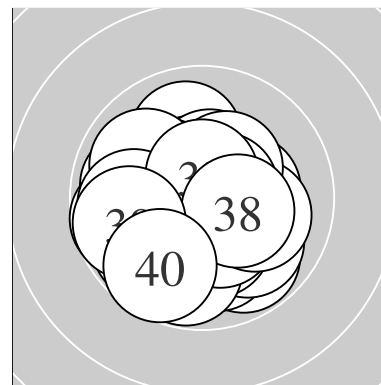

Serie 1:
 10.7 * 10.2 * 10.3 * 10.7 * 9.8 ↘
 9.9 ← 10.6 * 10.0 ↓ 10.5 * 10.7 *
 beste Teiler 67.0 (1.) 69.5 (10.) 75.6 (4.)
 Trefferlage 0.04 mm rechts, 0.46 mm tief
 Streuwert 1.25, horizontal: 1.40, vertikal: 1.07

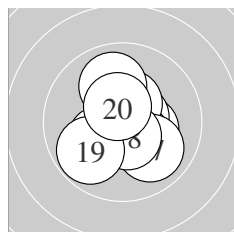

Serie 2:
 10.3 * 10.6 * 10.4 * 10.2 * 10.4 *
 10.0 ↑ 10.0 ↘ 10.6 * 9.8 ✓ 10.5 *
 beste Teiler 89.3 (12.) 96.4 (18.) 108.4 (20.)
 Trefferlage 0.12 mm rechts, 0.21 mm tief
 Streuwert 1.33, horizontal: 1.25, vertikal: 1.40

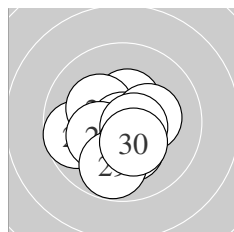

Serie 3:
 10.4 * 9.7 ← 10.2 * 10.8 * 10.3 *
 10.3 * 10.6 * 10.2 * 9.8 ↓ 10.4 *
 beste Teiler 26.0 (24.) 80.6 (27.) 130.7 (21.)
 Trefferlage 0.26 mm links, 0.56 mm tief
 Streuwert 1.32, horizontal: 1.40, vertikal: 1.23

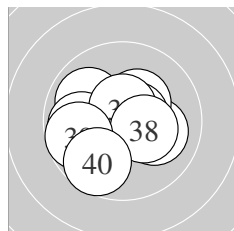

Serie 4:
 9.9 ↘ 10.0 ← 10.1 → 10.3 * 9.9 ←
 10.6 * 10.6 * 10.3 * 9.7 ← 9.7 ✓
 beste Teiler 85.9 (36.) 87.0 (37.) 151.2 (38.)
 Trefferlage 0.65 mm links, 0.23 mm tief
 Streuwert 1.59, horizontal: 1.90, vertikal: 1.21

Unterschrift des Schuetzen

Meyton Elektronik

Ergebnis:	415.7	(396) ^{QF}
Serien:	104.8	104.8 103.6 102.5
Zaehler:	36	4 0 0 0 0 0 0 0 0
Innenzehner:	35	
weiteste:	368	(40), 336 (34), 320 (21)
beste Teiler	27.5	(36.) 45.6 (39.) 51.4 (2.)
Trefferlage	0.10 mm	links, 0.28 mm hoch
Streuwert	1.12,	horizontal: 0.96, vertikal: 1.25

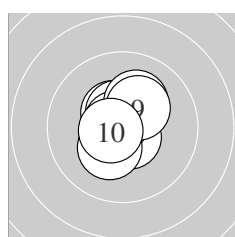
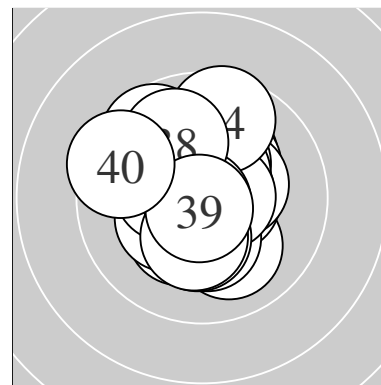

Serie 1:	10.5 *	10.7 *	10.5 *	10.4 *	10.6 *
	10.7 *	10.3 *	10.2 *	10.3 *	10.6 *
beste Teiler	51.4	(2.) 54.0 (6.)	81.5 (5.)		
Trefferlage	0.04 mm	links, 0.44 mm	hoch		
Streuwert	0.89,	horizontal: 0.77,	vertikal: 1.00		

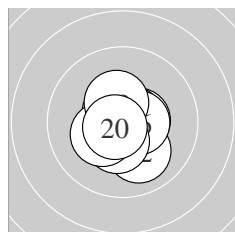

Serie 2:	10.5 *	10.0 ↘	10.6 *	10.7 *	10.7 *
	10.5 *	10.4 *	10.3 *	10.4 *	10.7 *
beste Teiler	52.2	(14.) 62.6 (15.)	64.3 (20.)		
Trefferlage	0.03 mm	rechts, 0.26 mm	tief		
Streuwert	0.92,	horizontal: 0.87,	vertikal: 0.97		

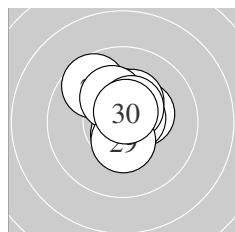

Serie 3:	9.7 ↙	10.3 *	10.4 *	10.6 *	10.6 *
	10.3 *	10.2 *	10.5 *	10.4 *	10.6 *
beste Teiler	76.2	(30.) 80.6 (25.)	81.0 (24.)		
Trefferlage	0.07 mm	rechts, 0.76 mm	hoch		
Streuwert	1.05,	horizontal: 0.93,	vertikal: 1.15		

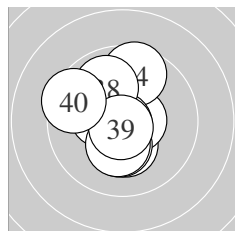

Serie 4:	10.3 *	10.4 *	10.6 *	9.6 ↑	10.3 *
	10.8 *	10.3 *	9.9 ↘	10.8 *	9.5 ↙
beste Teiler	27.5	(36.) 45.6 (39.)	83.1 (33.)		
Trefferlage	0.49 mm	links, 0.18 mm	hoch		
Streuwert	1.49,	horizontal: 1.25,	vertikal: 1.70		

QF – Schütze hat sich fürs Finale qualifiziert

Unterschrift des Schuetzen

Meyton Elektronik

ISSF AR Women – Wertung – Frauen

StartNr: 7

StandNr: 111

23. Januar 2017 16:24

Emily, Stith #70804589

USA

Ergebnis: **0.0** (0)_{DNS}
Serien:
Zähler: 0 0 0 0 0 0 0 0 0 0
Innenzehner: 0
weiteste:
~~beste~~ Teiler – Schütze ist nicht zum Wettkampf angetreten
Trefferlage 0.00 mm , 0.00 mm
Streuwert
Unterschrift des Schuetzen

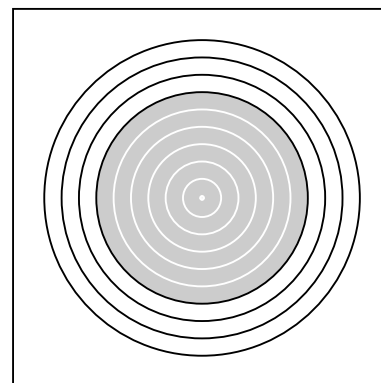

Meyton Elektronik

Ergebnis: **401.3** (383)
 Serien: 103.3 100.1 98.6 99.3
 Zaehler: 25 13 2 0 0 0 0 0 0 0
 Innenzehner: 19
 weiteste: 728 (37), 529 (28), 453 (19)
 beste Teiler 19.0 (6.) 30.0 (8.) 38.0 (36.)
 Trefferlage 0.09 mm links, 0.33 mm tief
 Streuwert 1.93, horizontal: 1.97, vertikal: 1.89

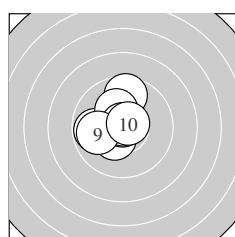
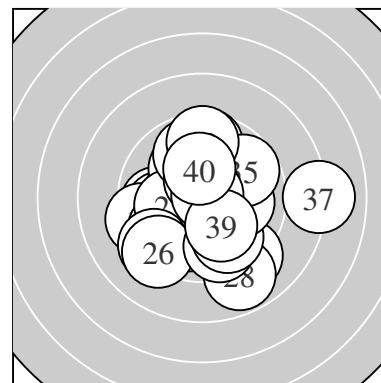

Serie 1:
 9.6 ↑ 10.5 * 10.5 * 10.4 * 9.8 ←
 10.9 * 10.2 * 10.8 * 9.9 ← 10.7 *
 beste Teiler 19.0 (6.) 30.0 (8.) 67.6 (10.)
 Trefferlage 0.75 mm links, 0.39 mm hoch
 Streuwert 1.24, horizontal: 1.14, vertikal: 1.34

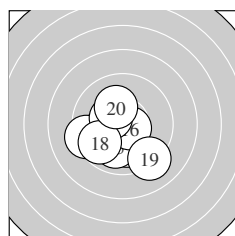

Serie 2:
 10.0 ↓ 10.2 * 9.4 ← 10.5 * 10.0 ↓
 10.6 * 10.4 * 9.7 ← 9.1 ↓ 10.2 *
 beste Teiler 85.9 (16.) 113.6 (14.) 137.7 (17.)
 Trefferlage 0.77 mm links, 0.94 mm tief
 Streuwert 1.72, horizontal: 1.81, vertikal: 1.63

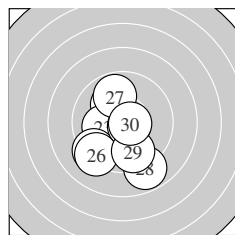

Serie 3:
 10.4 * 10.1 ↘ 10.1 ← 9.3 ✓ 10.6 *
 9.2 ✓ 9.8 ↑ 8.8 ↓ 9.7 ↓ 10.6 *
 beste Teiler 79.0 (25.) 79.6 (30.) 142.1 (21.)
 Trefferlage 0.43 mm links, 1.19 mm tief
 Streuwert 2.09, horizontal: 1.77, vertikal: 2.36

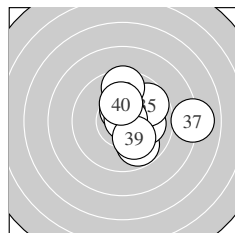

Serie 4:
 10.6 * 9.8 ↓ 10.5 * 10.0 → 9.7 ↗
 10.8 * 8.0 → 9.6 ↑ 10.1 ↓ 10.2 *
 beste Teiler 38.0 (36.) 85.0 (31.) 114.8 (33.)
 Trefferlage 1.57 mm rechts, 0.41 mm hoch
 Streuwert 1.99, horizontal: 2.23, vertikal: 1.73

Unterschrift des Schuetzen

Meyton Elektronik

Ergebnis: **410.3** (396)

Serien: 101.9 103.3 102.1 103.0

Zaehler: 36 4 0 0 0 0 0 0 0 0

Innenzehner: 27

weiteste: 341 (6), 285 (24), 272 (25)

beste Teiler 43.9 (11.) 79.6 (23.) 93.2 (38.)

Trefferlage 0.33 mm rechts, 0.42 mm hoch

Streuwert 1.27, horizontal: 1.35, vertikal: 1.19

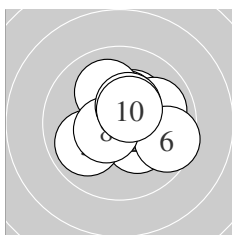
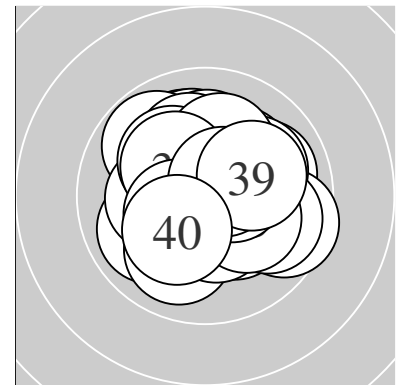

Serie 1:

10.3 *	10.3 *	9.9 ↙	10.0 →	10.4 *
9.6 →	10.0 ↕	10.5 *	10.4 *	10.5 *

beste Teiler 101.0 (8.) 116.2 (10.) 134.1 (9.)

Trefferlage 0.53 mm rechts, 0.38 mm hoch

Streuwert 1.43, horizontal: 1.58, vertikal: 1.27

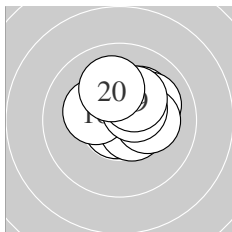

Serie 2:

10.8 *	10.6 *	10.3 *	10.2 *	10.1 →
10.3 *	10.2 *	10.5 *	10.2 *	10.1 ↕

beste Teiler 43.9 (11.) 99.8 (12.) 125.8 (18.)

Trefferlage 0.69 mm rechts, 0.76 mm hoch

Streuwert 1.02, horizontal: 1.14, vertikal: 0.87

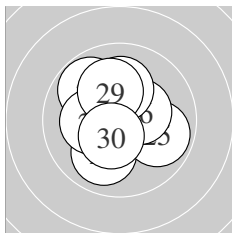

Serie 3:

10.5 *	10.0 ↙	10.6 *	9.8 ↘	9.9 →
10.4 *	10.2 *	10.1 ↑	10.1 ↕	10.5 *

beste Teiler 79.6 (23.) 116.8 (21.) 122.1 (30.)

Trefferlage 0.07 mm links, 0.36 mm hoch

Streuwert 1.45, horizontal: 1.44, vertikal: 1.46

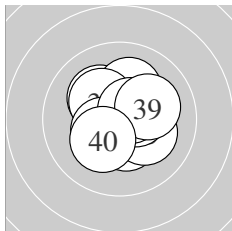

Serie 4:

10.2 *	10.1 ↑	10.4 *	10.3 *	10.2 *
10.5 *	10.4 *	10.6 *	10.1 →	10.2 *

beste Teiler 93.2 (38.) 115.4 (36.) 132.3 (37.)

Trefferlage 0.17 mm rechts, 0.20 mm hoch

Streuwert 1.24, horizontal: 1.26, vertikal: 1.21

Unterschrift des Schuetzen

Ergebnis: **414.1** (395)
 Serien: 102.4 102.7 105.4 103.6
 Zaehler: 35 5 0 0 0 0 0 0 0 0
 Innenzehner: 33
 weiteste: 415 (1), 411 (2), 411 (15)
 beste Teiler 17.6 (23.) 22.4 (19.) 59.5 (32.)
 Trefferlage 0.08 mm links, 0.06 mm tief
 Streuwert 1.27, horizontal: 1.38, vertikal: 1.14

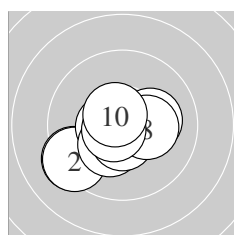
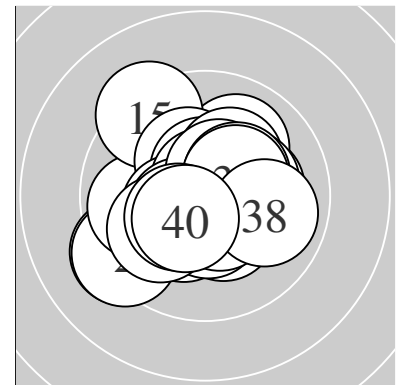

Serie 1:
 9.3 ↙ 9.3 ↙ 10.5 * 10.6 * 10.2 *
 10.3 * 10.6 * 10.3 * 10.7 * 10.6 *
 beste Teiler 69.3 (9.) 80.8 (4.) 90.2 (10.)
 Trefferlage 0.54 mm links, 0.64 mm tief
 Streuwert 1.50, horizontal: 1.82, vertikal: 1.09

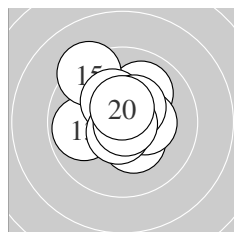

Serie 2:
 10.3 * 10.0 ↗ 9.9 ← 10.3 * 9.3 ↘
 10.3 * 10.7 * 10.4 * 10.9 * 10.6 *
 beste Teiler 22.4 (19.) 75.2 (17.) 100.0 (20.)
 Trefferlage 0.14 mm links, 0.63 mm hoch
 Streuwert 1.43, horizontal: 1.43, vertikal: 1.42

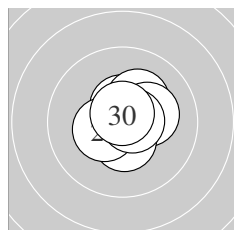

Serie 3:
 10.7 * 10.5 * 10.9 * 10.6 * 10.2 *
 10.2 * 10.5 * 10.4 * 10.7 * 10.7 *
 beste Teiler 17.6 (23.) 61.0 (30.) 69.5 (29.)
 Trefferlage 0.14 mm rechts, 0.08 mm hoch
 Streuwert 0.84, horizontal: 0.83, vertikal: 0.85

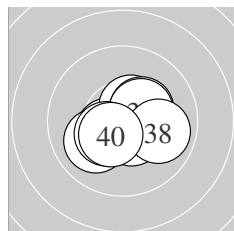

Serie 4:
 10.5 * 10.7 * 10.5 * 10.5 * 10.3 *
 10.0 ↙ 10.4 * 9.9 → 10.4 * 10.4 *
 beste Teiler 59.5 (32.) 108.4 (34.) 113.0 (33.)
 Trefferlage 0.19 mm rechts, 0.32 mm tief
 Streuwert 1.14, horizontal: 1.36, vertikal: 0.85

Unterschrift des Schuetzen

Meyton Elektronik

Ergebnis: **415.4** (396)
 Serien: 103.6 102.7 104.5 104.6
 Zaehler: 36 4 0 0 0 0 0 0 0 0
 Innenzehner: 33
 weiteste: 363 (5), 361 (12), 288 (13)
 beste Teiler 10.2 (18.) 29.0 (29.) 47.2 (37.)
 Trefferlage 0.40 mm rechts, 0.05 mm hoch
 Streuwert 1.12, horizontal: 1.28, vertikal: 0.94

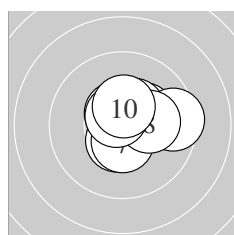
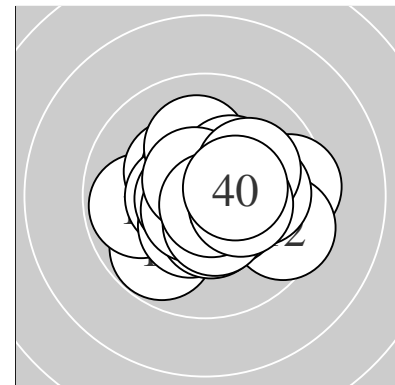

Serie 1:
 10.3 * 10.6 * 10.6 * 10.5 * 9.5 →
 10.4 * 10.5 * 10.2 * 10.6 * 10.4 *
 beste Teiler 79.3 (9.) 82.7 (2.) 98.9 (3.)
 Trefferlage 0.72 mm rechts, 0.35 mm hoch
 Streuwert 1.10, horizontal: 1.31, vertikal: 0.85

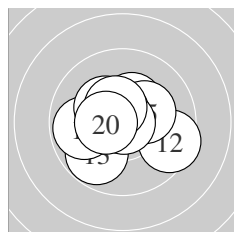

Serie 2:
 10.4 * 9.5 ↘ 9.8 ↙ 9.8 ← 10.3 *
 10.7 * 10.3 * 10.9 * 10.5 * 10.5 *
 beste Teiler 10.2 (18.) 72.4 (16.) 117.6 (19.)
 Trefferlage 0.22 mm links, 0.06 mm hoch
 Streuwert 1.48, horizontal: 1.76, vertikal: 1.14

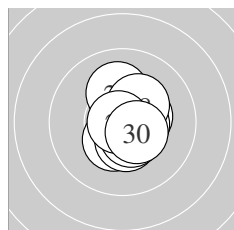

Serie 3:
 10.4 * 10.6 * 10.1 ↑ 10.4 * 10.5 *
 10.4 * 10.5 * 10.3 * 10.8 * 10.5 *
 beste Teiler 29.0 (29.) 89.0 (22.) 112.1 (25.)
 Trefferlage 0.47 mm rechts, 0.13 mm tief
 Streuwert 0.92, horizontal: 0.70, vertikal: 1.10

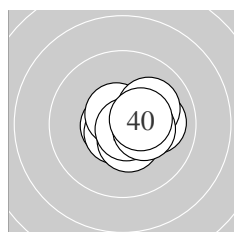

Serie 4:
 10.0 → 10.6 * 10.6 * 10.7 * 10.6 *
 10.5 * 10.8 * 10.1 ↗ 10.3 * 10.4 *
 beste Teiler 47.2 (37.) 59.6 (34.) 78.7 (33.)
 Trefferlage 0.65 mm rechts, 0.06 mm tief
 Streuwert 0.88, horizontal: 1.07, vertikal: 0.66

Unterschrift des Schuetzen

Meyton Elektronik

Ergebnis: **414.6** (398)
 Serien: 103.7 103.7 103.4 103.8
 Zaehler: 38 2 0 0 0 0 0 0 0 0
 Innenzehner: 34
 weiteste: 488 (28), 292 (35), 241 (19)
 beste Teiler 16.1 (27.) 50.0 (32.) 51.0 (13.)
 Trefferlage 0.18 mm links, 0.22 mm tief
 Streuwert 1.19, horizontal: 1.48, vertikal: 0.78

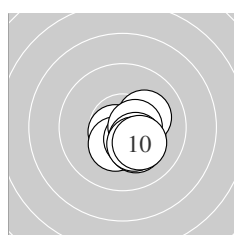
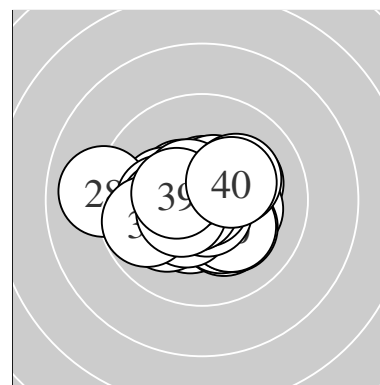

Serie 1:
 10.4 * 10.7 * 10.3 * 10.2 * 10.5 *
 10.2 * 10.5 * 10.4 * 10.3 * 10.2 *
 beste Teiler 72.4 (2.) 103.0 (7.) 120.1 (5.)
 Trefferlage 0.81 mm rechts, 0.77 mm tief
 Streuwert 0.77, horizontal: 0.80, vertikal: 0.75

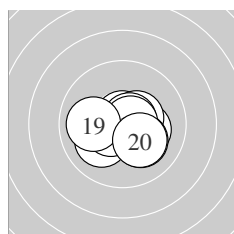

Serie 2:
 10.1 ↙ 10.2 * 10.7 * 10.5 * 10.5 *
 10.1 ↘ 10.7 * 10.7 * 10.0 ← 10.2 *
 beste Teiler 51.0 (13.) 65.5 (17.) 66.4 (18.)
 Trefferlage 0.19 mm rechts, 0.34 mm tief
 Streuwert 1.15, horizontal: 1.45, vertikal: 0.75

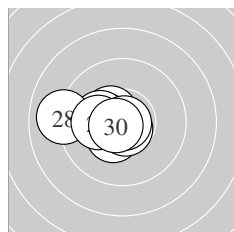

Serie 3:
 10.5 * 10.4 * 10.7 * 10.5 * 10.4 *
 10.2 * 10.9 * 9.0 ← 10.1 ← 10.7 *
 beste Teiler 16.1 (27.) 60.9 (23.) 62.6 (30.)
 Trefferlage 1.32 mm links, 0.05 mm tief
 Streuwert 1.09, horizontal: 1.45, vertikal: 0.52

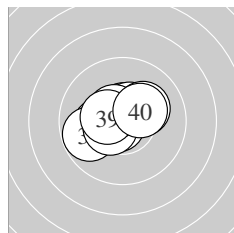

Serie 4:
 10.2 * 10.8 * 10.6 * 10.5 * 9.8 ←
 10.5 * 10.5 * 10.2 * 10.4 * 10.3 *
 beste Teiler 50.0 (32.) 92.2 (33.) 102.6 (37.)
 Trefferlage 0.41 mm links, 0.26 mm hoch
 Streuwert 1.13, horizontal: 1.40, vertikal: 0.77

Unterschrift des Schuetzen

Meyton Elektronik

Ergebnis: **404.6** (388)
 Serien: 101.0 101.5 100.1 102.0
 Zaehler: 29 10 1 0 0 0 0 0 0 0
 Innenzehner: 23
 weiteste: 515 (21), 431 (31), 389 (18)
 beste Teiler 45.1 (17.) 61.2 (35.) 69.1 (22.)
 Trefferlage 0.67 mm links, 0.13 mm tief
 Streuwert 1.62, horizontal: 1.83, vertikal: 1.37

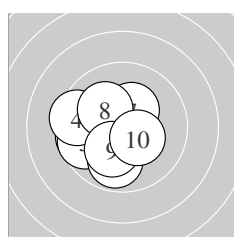
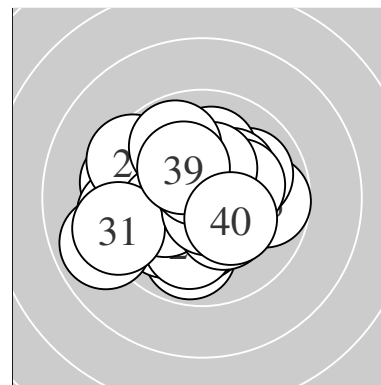

Serie 1:
 9.6 ← 10.6 * 9.7 ← 9.5 ← 9.9 ↓
 10.6 * 10.3 * 10.2 * 10.2 * 10.4 *
 beste Teiler 76.4 (2.) 76.9 (6.) 147.6 (10.)
 Trefferlage 1.06 mm links, 0.34 mm tief
 Streuwert 1.56, horizontal: 1.73, vertikal: 1.37

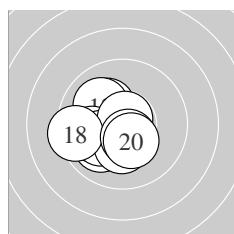

Serie 2:
 10.0 ↗ 10.2 * 10.0 ↘ 9.9 ← 10.1 ←
 10.2 * 10.8 * 9.4 ← 10.5 * 10.4 *
 beste Teiler 45.1 (17.) 113.3 (19.) 150.7 (20.)
 Trefferlage 1.15 mm links, 0.50 mm tief
 Streuwert 1.33, horizontal: 1.45, vertikal: 1.21

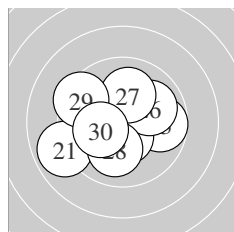

Serie 3:
 8.9 ← 10.7 * 9.7 → 10.5 * 10.5 *
 10.0 ↗ 10.1 ↑ 10.1 ↓ 9.4 ↘ 10.2 *
 beste Teiler 69.1 (22.) 111.0 (25.) 119.8 (24.)
 Trefferlage 0.48 mm links, 0.08 mm tief
 Streuwert 1.98, horizontal: 2.32, vertikal: 1.57

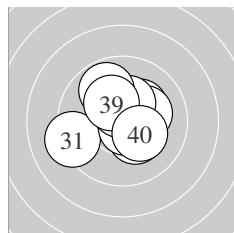

Serie 4:
 9.2 ← 10.2 * 10.3 * 10.2 * 10.7 *
 10.6 * 10.4 * 9.8 ↘ 10.3 * 10.3 *
 beste Teiler 61.2 (35.) 93.6 (36.) 150.2 (37.)
 Trefferlage 0.01 mm links, 0.38 mm hoch
 Streuwert 1.56, horizontal: 1.74, vertikal: 1.35

Unterschrift des Schuetzen

Meyton Elektronik

Ergebnis: **417.1** (399)^{QF}
 Serien: 103.4 104.5 104.1 105.1
 Zaehler: 39 1 0 0 0 0 0 0 0 0
 Innenzehner: 36
 weiteste: 376 (10), 225 (12), 220 (30)
 beste Teiler 31.5 (16.) 33.2 (29.) 42.3 (32.)
 Trefferlage 0.13 mm rechts, 0.08 mm hoch
 Streuwert 1.05, horizontal: 1.00, vertikal: 1.10

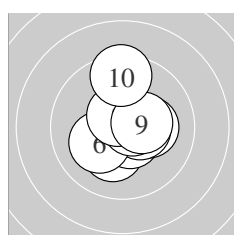
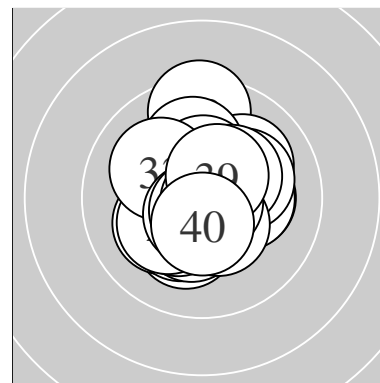

Serie 1:
 10.2 * 10.6 * 10.7 * 10.2 * 10.4 *
 10.2 * 10.7 * 10.6 * 10.4 * 9.4 ↑
 beste Teiler 54.8 (3.) 72.5 (7.) 92.7 (8.)
 Trefferlage 0.30 mm rechts, 0.18 mm hoch
 Streuwert 1.29, horizontal: 1.07, vertikal: 1.48

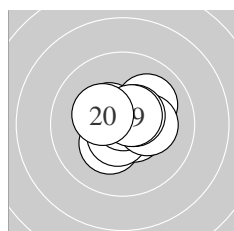

Serie 2:
 10.5 * 10.1 ↗ 10.3 * 10.6 * 10.6 *
 10.8 * 10.2 * 10.5 * 10.6 * 10.3 *
 beste Teiler 31.5 (16.) 89.1 (19.) 89.5 (15.)
 Trefferlage 0.21 mm rechts, 0.16 mm hoch
 Streuwert 1.01, horizontal: 1.14, vertikal: 0.85

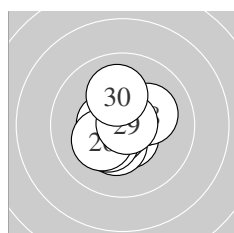

Serie 3:
 10.6 * 10.4 * 10.5 * 10.7 * 10.3 *
 10.2 * 10.3 * 10.2 * 10.8 * 10.1 ↑
 beste Teiler 33.2 (29.) 70.9 (24.) 99.0 (21.)
 Trefferlage 0.11 mm links, 0.12 mm tief
 Streuwert 1.10, horizontal: 1.07, vertikal: 1.13

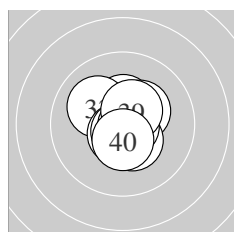

Serie 4:
 10.4 * 10.8 * 10.1 ↖ 10.3 * 10.6 *
 10.7 * 10.4 * 10.8 * 10.5 * 10.5 *
 beste Teiler 42.3 (32.) 45.3 (38.) 54.4 (36.)
 Trefferlage 0.13 mm rechts, 0.09 mm hoch
 Streuwert 0.90, horizontal: 0.82, vertikal: 0.98

QF – Schütze hat sich fürs Finale qualifiziert

Unterschrift des Schuetzen

Meyton Elektronik

Ergebnis: **414.7** (397)
 Serien: 103.8 101.8 103.4 105.7
 Zaehler: 37 3 0 0 0 0 0 0 0 0
 Innenzehner: 32
 weiteste: 274 (18), 273 (15), 265 (19)
 beste Teiler 48.3 (40.) 49.7 (39.) 51.1 (32.)
 Trefferlage 0.20 mm links, 0.08 mm tief
 Streuwert 1.14, horizontal: 1.09, vertikal: 1.19

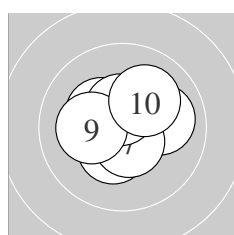
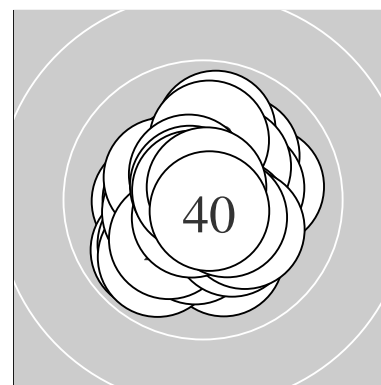

Serie 1:
 10.0 → 10.7 * 10.4 * 10.6 * 10.3 *
 10.4 * 10.6 * 10.5 * 10.2 * 10.1 ↗
 beste Teiler 55.5 (2.) 78.7 (4.) 98.0 (7.)
 Trefferlage 0.12 mm links, 0.33 mm hoch
 Streuwert 1.12, horizontal: 1.30, vertikal: 0.90

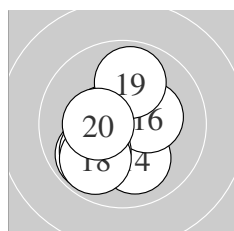

Serie 2:
 10.6 * 10.3 * 10.6 * 10.0 ↓ 9.9 ↘
 10.3 * 10.0 ↙ 9.9 ↙ 9.9 ↑ 10.3 *
 beste Teiler 99.4 (13.) 100.2 (11.) 153.0 (20.)
 Trefferlage 0.58 mm links, 0.49 mm tief
 Streuwert 1.43, horizontal: 1.24, vertikal: 1.60

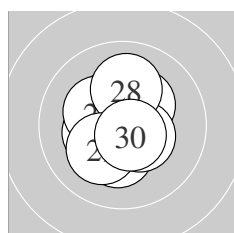

Serie 3:
 10.4 * 10.3 * 10.3 * 10.5 * 10.3 *
 10.3 * 10.4 * 10.1 ↑ 10.2 * 10.6 *
 beste Teiler 79.8 (30.) 103.8 (24.) 127.3 (27.)
 Trefferlage 0.27 mm links, 0.02 mm tief
 Streuwert 1.17, horizontal: 0.98, vertikal: 1.33

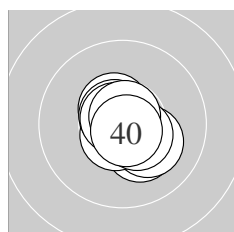

Serie 4:
 10.2 * 10.7 * 10.2 * 10.6 * 10.5 *
 10.5 * 10.7 * 10.7 * 10.8 * 10.8 *
 beste Teiler 48.3 (40.) 49.7 (39.) 51.1 (32.)
 Trefferlage 0.17 mm rechts, 0.14 mm tief
 Streuwert 0.78, horizontal: 0.76, vertikal: 0.80

Unterschrift des Schuetzen

Ergebnis: **415.9** (397)^{QF}
 Serien: 103.7 103.7 103.3 105.2
 Zaehler: 37 3 0 0 0 0 0 0 0 0
 Innenzehner: 33
 weiteste: 285 (39), 253 (3), 252 (14)
 beste Teiler 34.2 (36.) 36.0 (34.) 44.9 (33.)
 Trefferlage 0.07 mm links, 0.11 mm tief
 Streuwert 1.08, horizontal: 1.19, vertikal: 0.97

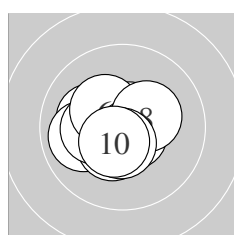
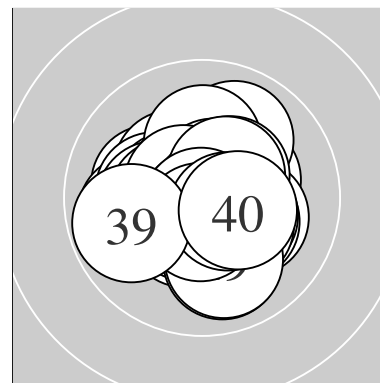

Serie 1:
 10.7 * 10.1 ← 9.9 ← 10.4 * 10.3 *
 10.3 * 10.7 * 10.3 * 10.5 * 10.5 *
 beste Teiler 73.0 (7.) 74.3 (1.) 102.5 (9.)
 Trefferlage 0.60 mm links, 0.12 mm tief
 Streuwert 1.05, horizontal: 1.25, vertikal: 0.81

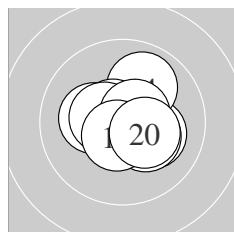

Serie 2:
 10.2 * 10.2 * 10.5 * 9.9 ↗ 10.6 *
 10.3 * 10.5 * 10.6 * 10.6 * 10.3 *
 beste Teiler 77.6 (15.) 90.2 (18.) 92.3 (19.)
 Trefferlage 0.34 mm rechts, 0.14 mm hoch
 Streuwert 1.12, horizontal: 1.24, vertikal: 0.98

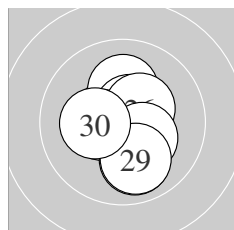

Serie 3:
 10.6 * 10.6 * 10.1 ↑ 10.6 * 10.4 *
 10.4 * 10.3 * 10.0 ↓ 10.0 ↓ 10.3 *
 beste Teiler 88.6 (24.) 88.8 (22.) 89.9 (21.)
 Trefferlage 0.10 mm rechts, 0.25 mm tief
 Streuwert 1.23, horizontal: 1.02, vertikal: 1.41

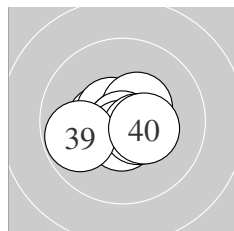

Serie 4:
 10.4 * 10.6 * 10.8 * 10.8 * 10.5 *
 10.8 * 10.6 * 10.5 * 9.8 ← 10.4 *
 beste Teiler 34.2 (36.) 36.0 (34.) 44.9 (33.)
 Trefferlage 0.13 mm links, 0.22 mm tief
 Streuwert 0.94, horizontal: 1.20, vertikal: 0.58

QF – Schütze hat sich fürs Finale qualifiziert

Unterschrift des Schuetzen

Meyton Elektronik

Ergebnis: **415.3** (397)
 Serien: 103.2 103.2 104.1 104.8
 Zaehler: 37 3 0 0 0 0 0 0 0 0
 Innenzehner: 32
 weiteste: 331 (12), 318 (8), 258 (27)
 beste Teiler 14.3 (29.) 48.7 (32.) 48.7 (35.)
 Trefferlage 0.34 mm links, 0.69 mm hoch
 Streuwert 1.00, horizontal: 1.11, vertikal: 0.88

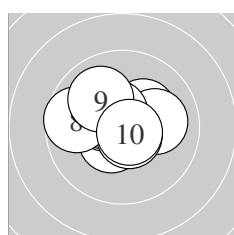
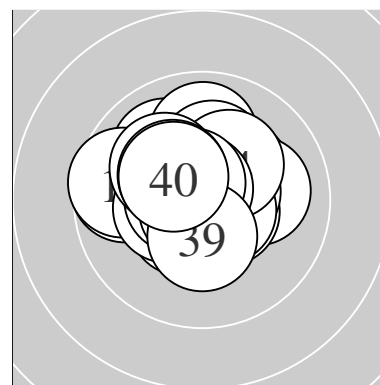

Serie 1:
 10.3 * 10.5 * 10.1 → 10.4 * 10.5 *
 10.3 * 10.7 * 9.7 ← 10.0 ↖ 10.7 *
 beste Teiler 58.6 (10.) 73.4 (7.) 112.2 (5.)
 Trefferlage 0.40 mm links, 0.44 mm hoch
 Streuwert 1.26, horizontal: 1.57, vertikal: 0.84

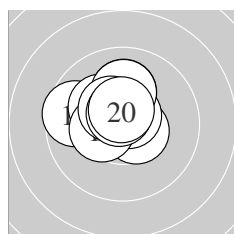

Serie 2:
 10.1 ↑ 9.6 ← 10.5 * 10.7 * 10.2 *
 10.1 ↑ 10.4 * 10.4 * 10.6 * 10.6 *
 beste Teiler 71.0 (14.) 76.8 (19.) 98.4 (20.)
 Trefferlage 0.57 mm links, 0.87 mm hoch
 Streuwert 1.05, horizontal: 1.20, vertikal: 0.87

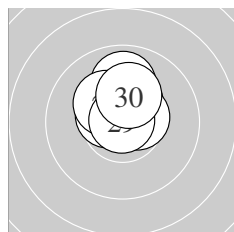

Serie 3:
 10.5 * 10.4 * 10.4 * 10.4 * 10.6 *
 10.5 * 9.9 ↑ 10.3 * 10.9 * 10.2 *
 beste Teiler 14.3 (29.) 80.6 (25.) 102.7 (26.)
 Trefferlage 0.02 mm links, 1.10 mm hoch
 Streuwert 0.74, horizontal: 0.71, vertikal: 0.77

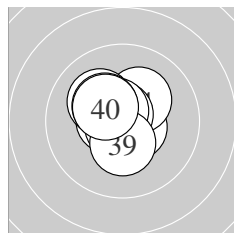

Serie 4:
 10.6 * 10.8 * 10.6 * 10.2 * 10.8 *
 10.6 * 10.1 ↘ 10.3 * 10.4 * 10.4 *
 beste Teiler 48.7 (32.) 48.7 (35.) 84.3 (36.)
 Trefferlage 0.39 mm links, 0.37 mm hoch
 Streuwert 0.89, horizontal: 0.87, vertikal: 0.92

Unterschrift des Schuetzen

Meyton Elektronik

Ergebnis: **412.7** (393)
 Serien: 101.1 105.6 104.1 101.9
 Zaehler: 33 7 0 0 0 0 0 0 0 0
 Innenzehner: 27
 weiteste: 372 (5), 348 (8), 329 (10)
 beste Teiler 7.6 (3.) 23.0 (16.) 27.8 (29.)
 Trefferlage 0.18 mm links, 0.48 mm hoch
 Streuwert 1.28, horizontal: 1.39, vertikal: 1.16

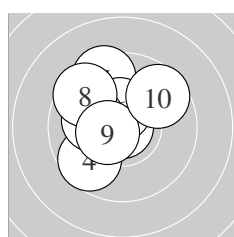
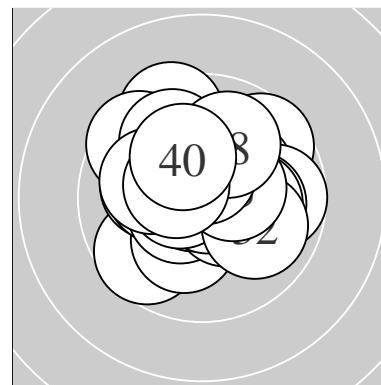

Serie 1:
 10.3 * 10.4 * 10.9 * 9.7 ↙ 9.5 ↗
 10.5 * 10.1 ← 9.6 ↘ 10.5 * 9.6 ↗
 beste Teiler 7.6 (3.) 112.6 (9.) 125.6 (6.)
 Trefferlage 0.98 mm links, 0.85 mm hoch
 Streuwert 1.54, horizontal: 1.47, vertikal: 1.60

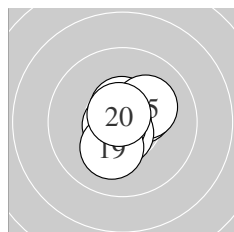

Serie 2:
 10.6 * 10.6 * 10.4 * 10.7 * 10.2 *
 10.9 * 10.6 * 10.7 * 10.2 * 10.7 *
 beste Teiler 23.0 (16.) 58.2 (14.) 59.9 (20.)
 Trefferlage 0.09 mm rechts, 0.08 mm hoch
 Streuwert 0.84, horizontal: 0.79, vertikal: 0.89

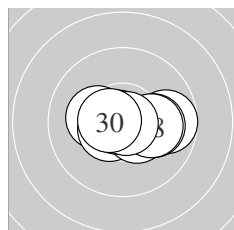

Serie 3:
 10.2 * 10.5 * 10.8 * 10.5 * 9.7 →
 10.1 → 10.8 * 10.1 → 10.8 * 10.6 *
 beste Teiler 27.8 (29.) 29.0 (23.) 38.0 (27.)
 Trefferlage 0.42 mm rechts, 0.13 mm tief
 Streuwert 1.13, horizontal: 1.57, vertikal: 0.29

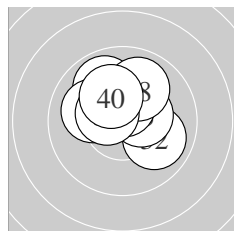

Serie 4:
 10.0 ↘ 9.9 ↘ 9.9 ↘ 10.1 ← 10.4 *
 10.4 * 10.5 * 10.0 ↑ 10.5 * 10.2 *
 beste Teiler 113.2 (37.) 122.0 (39.) 138.5 (35.)
 Trefferlage 0.24 mm links, 1.13 mm hoch
 Streuwert 1.23, horizontal: 1.37, vertikal: 1.08

Unterschrift des Schuetzen

Ergebnis:	412.2	(395)
Serien:	103.8	103.2 103.1 102.1
Zaehler:	35	5 0 0 0 0 0 0 0 0
Innenzehner:	29	
weiteste:	305	(25), 289 (28), 284 (32)
beste Teiler	49.5	(2.) 50.2 (27.) 58.0 (5.)
Trefferlage	0.18 mm rechts, 0.20 mm hoch	
Streuwert	1.25, horizontal: 1.26, vertikal: 1.24	

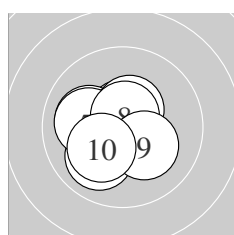
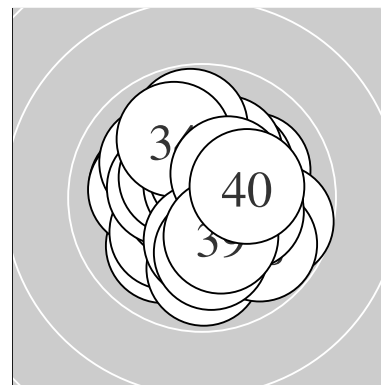

Serie 1:	10.6 *	10.8 *	10.1 ←	10.5 *	10.7 *
	10.0 ↙	10.1 ←	10.6 *	10.2 *	10.2 *
beste Teiler	49.5 (2.) 58.0 (5.) 77.4 (8.)				
Trefferlage	0.60 mm links, 0.07 mm tief				
Streuwert	1.12, horizontal: 1.19, vertikal: 1.05				

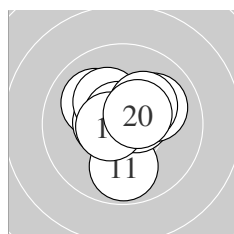

Serie 2:	9.8 ↓	10.1 ↖	10.5 *	10.6 *	10.2 *
	10.7 *	10.0 ↗	10.6 *	10.2 *	10.5 *
beste Teiler	61.2 (16.) 83.3 (18.) 96.7 (14.)				
Trefferlage	0.03 mm rechts, 0.39 mm hoch				
Streuwert	1.23, horizontal: 1.22, vertikal: 1.23				

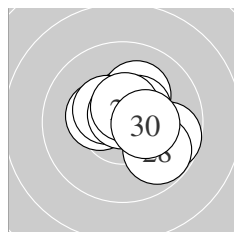

Serie 3:	10.4 *	10.2 *	10.5 *	10.3 *	9.7 →
	10.4 *	10.8 *	9.8 ↘	10.6 *	10.4 *
beste Teiler	50.2 (27.) 99.1 (29.) 124.8 (23.)				
Trefferlage	0.64 mm rechts, 0.36 mm hoch				
Streuwert	1.22, horizontal: 1.36, vertikal: 1.06				

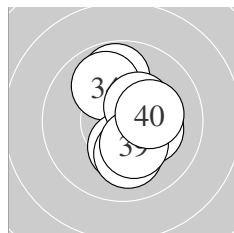

Serie 4:	10.3 *	9.8 ↑	10.6 *	9.9 ↖	10.2 *
	10.3 *	10.4 *	10.1 ↓	10.3 *	10.2 *
beste Teiler	94.8 (33.) 138.6 (37.) 167.0 (36.)				
Trefferlage	0.65 mm rechts, 0.12 mm hoch				
Streuwert	1.35, horizontal: 0.97, vertikal: 1.64				

Unterschrift des Schuetzen

Ergebnis: **411.9** (397)
 Serien: 101.9 102.6 104.5 102.9
 Zaehler: 37 3 0 0 0 0 0 0 0 0
 Innenzehner: 28
 weiteste: 301 (39), 256 (4), 256 (8)
 beste Teiler 52.6 (22.) 66.9 (40.) 77.6 (24.)
 Trefferlage 0.09 mm links, 0.60 mm hoch
 Streuwert 1.16, horizontal: 1.12, vertikal: 1.20

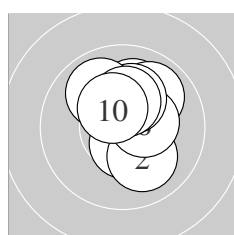
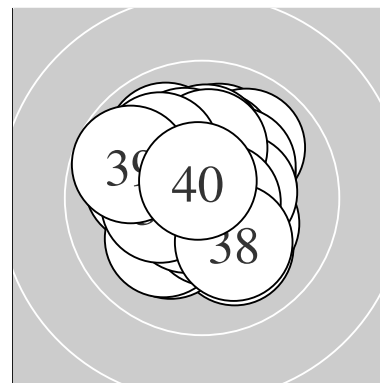

Serie 1:
 10.5 * 10.1 ↘ 10.1 ↑ 9.9 ↗ 10.1 ↖
 10.4 * 10.2 * 9.9 ↘ 10.3 * 10.4 *
 beste Teiler 103.6 (1.) 137.7 (10.) 140.9 (6.)
 Trefferlage 0.28 mm rechts, 1.01 mm hoch
 Streuwert 1.24, horizontal: 1.03, vertikal: 1.42

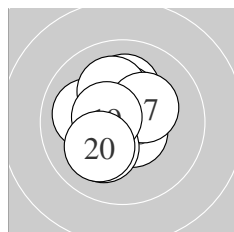

Serie 2:
 10.1 ↑ 10.3 * 10.0 ← 10.4 * 10.1 ↖
 10.6 * 10.3 * 10.2 * 10.5 * 10.1 ↗
 beste Teiler 89.0 (16.) 106.2 (19.) 137.5 (14.)
 Trefferlage 0.54 mm links, 0.44 mm hoch
 Streuwert 1.21, horizontal: 1.08, vertikal: 1.33

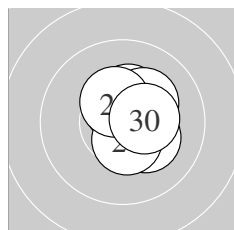

Serie 3:
 10.4 * 10.7 * 10.5 * 10.6 * 10.6 *
 10.2 * 10.2 * 10.5 * 10.4 * 10.4 *
 beste Teiler 52.6 (22.) 77.6 (24.) 100.4 (25.)
 Trefferlage 0.55 mm rechts, 0.45 mm hoch
 Streuwert 0.81, horizontal: 0.68, vertikal: 0.93

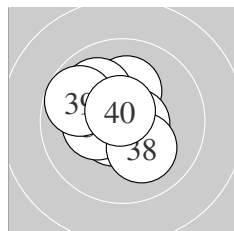

Serie 4:
 10.2 * 10.2 * 10.5 * 10.0 ↘ 10.6 *
 10.6 * 10.3 * 10.1 ↘ 9.7 ↖ 10.7 *
 beste Teiler 66.9 (40.) 77.6 (36.) 84.2 (35.)
 Trefferlage 0.68 mm links, 0.48 mm hoch
 Streuwert 1.19, horizontal: 1.21, vertikal: 1.17

Unterschrift des Schuetzen

Meyton Elektronik

Ergebnis: **414.1** (396)
 Serien: 104.1 102.7 103.1 104.2
 Zaehler: 36 4 0 0 0 0 0 0 0 0
 Innenzehner: 31
 weiteste: 294 (29), 281 (36), 274 (20)
 beste Teiler 3.0 (26.) 27.1 (17.) 45.0 (33.)
 Trefferlage 0.19 mm rechts, 0.12 mm hoch
 Streuwert 1.18, horizontal: 1.25, vertikal: 1.10

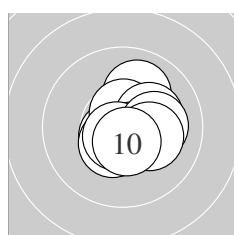
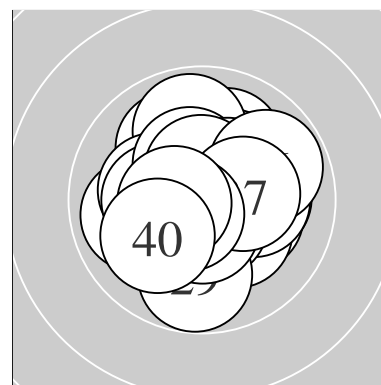

Serie 1:
 10.6 * 10.0 ↗ 10.5 * 10.6 * 10.2 *
 10.6 * 10.7 * 10.1 → 10.2 * 10.6 *
 beste Teiler 70.1 (7.) 80.1 (6.) 84.2 (1.)
 Trefferlage 0.56 mm rechts, 0.05 mm tief
 Streuwert 1.02, horizontal: 1.02, vertikal: 1.02

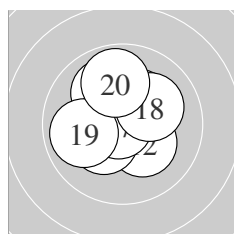

Serie 2:
 10.0 ↘ 10.2 * 10.6 * 10.6 * 10.3 *
 10.3 * 10.8 * 10.1 ↗ 9.9 ← 9.9 ↑
 beste Teiler 27.1 (17.) 94.0 (13.) 97.1 (14.)
 Trefferlage 0.24 mm links, 0.53 mm hoch
 Streuwert 1.32, horizontal: 1.32, vertikal: 1.31

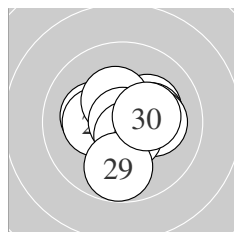

Serie 3:
 10.2 * 10.2 * 10.3 * 10.2 * 10.4 *
 10.9 * 10.2 * 10.6 * 9.8 ↓ 10.3 *
 beste Teiler 3.0 (26.) 94.1 (28.) 148.0 (25.)
 Trefferlage 0.30 mm rechts, 0.03 mm tief
 Streuwert 1.30, horizontal: 1.42, vertikal: 1.18

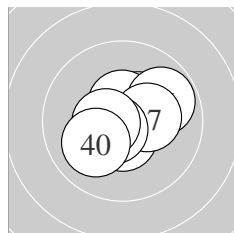

Serie 4:
 10.4 * 10.5 * 10.8 * 10.7 * 10.5 *
 9.8 ↗ 10.3 * 10.6 * 10.5 * 10.1 ↙
 beste Teiler 45.0 (33.) 62.1 (34.) 80.6 (38.)
 Trefferlage 0.13 mm rechts, 0.05 mm hoch
 Streuwert 1.11, horizontal: 1.28, vertikal: 0.91

Unterschrift des Schuetzen

ISSF AR Women – Wertung – Frauen

StartNr: 22

StandNr: 126

23. Januar 2017 16:27

Elizabeth, Marsh #70804595

USA

Ergebnis: **0.0** (0)_{DNS}

Serien:

Zähler: 0 0 0 0 0 0 0 0 0 0

Innenzehner: 0

weiteste:

~~beste Teiler~~ – Schütze ist nicht zum Wettkampf angetreten

Trefferlage 0.00 mm , 0.00 mm

Streuwert

Unterschrift des Schuetzen

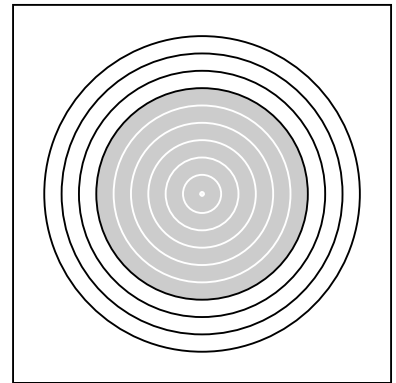

Meyton Elektronik

Ergebnis: **416.3** (396)^{QF}
 Serien: 103.9 104.8 102.5 105.1
 Zaehler: 36 4 0 0 0 0 0 0 0 0
 Innenzehner: 33
 weiteste: 348 (26), 330 (4), 278 (22)
 beste Teiler 27.8 (3.) 32.5 (2.) 33.8 (12.)
 Trefferlage 0.16 mm rechts, 0.39 mm hoch
 Streuwert 1.08, horizontal: 0.98, vertikal: 1.18

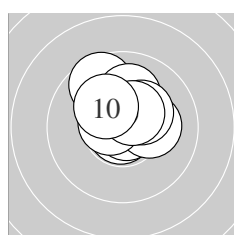
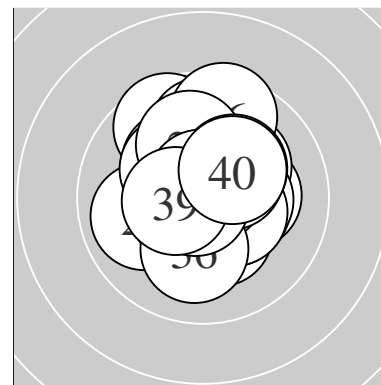

Serie 1:
 10.8 * 10.8 * 10.8 * 9.6 ↖ 10.2 *
 10.1 ↑ 10.6 * 10.3 * 10.5 * 10.2 *
 beste Teiler 27.8 (3.) 32.5 (2.) 34.5 (1.)
 Trefferlage 0.10 mm rechts, 0.88 mm hoch
 Streuwert 1.05, horizontal: 1.06, vertikal: 1.05

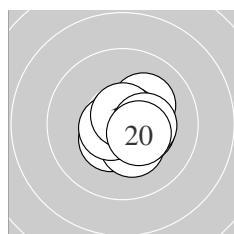

Serie 2:
 10.4 * 10.8 * 10.3 * 10.2 * 10.6 *
 10.7 * 10.4 * 10.7 * 10.3 * 10.4 *
 beste Teiler 33.8 (12.) 55.3 (16.) 62.0 (18.)
 Trefferlage 0.46 mm rechts, 0.17 mm tief
 Streuwert 0.86, horizontal: 0.91, vertikal: 0.80

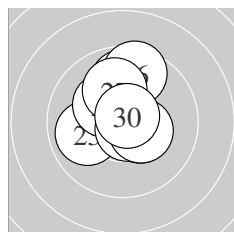

Serie 3:
 10.4 * 9.8 ↑ 9.9 ← 10.3 * 10.7 *
 9.6 ↑ 10.0 ↖ 10.7 * 10.4 * 10.7 *
 beste Teiler 53.6 (30.) 57.4 (28.) 66.4 (25.)
 Trefferlage 0.02 mm rechts, 0.71 mm hoch
 Streuwert 1.38, horizontal: 1.16, vertikal: 1.57

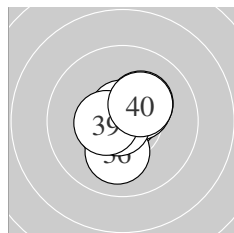

Serie 4:
 10.8 * 10.7 * 10.2 * 10.6 * 10.7 *
 10.1 ↓ 10.4 * 10.8 * 10.5 * 10.3 *
 beste Teiler 35.3 (38.) 45.5 (31.) 52.3 (32.)
 Trefferlage 0.08 mm rechts, 0.13 mm hoch
 Streuwert 0.93, horizontal: 0.86, vertikal: 1.00

QF – Schütze hat sich fürs Finale qualifiziert

Unterschrift des Schuetzen

Meyton Elektronik

Ergebnis: **420.3** (397)^{QF}
 Serien: 104.5 105.6 105.1 105.1
 Zaehler: 37 3 0 0 0 0 0 0 0 0
 Innenzehner: 35
 weiteste: 271 (15), 266 (2), 253 (6)
 beste Teiler 18.6 (5.) 22.8 (35.) 41.1 (11.)
 Trefferlage 0.21 mm rechts, 0.08 mm hoch
 Streuwert 0.90, horizontal: 0.97, vertikal: 0.83

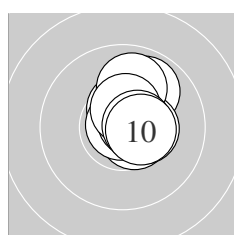
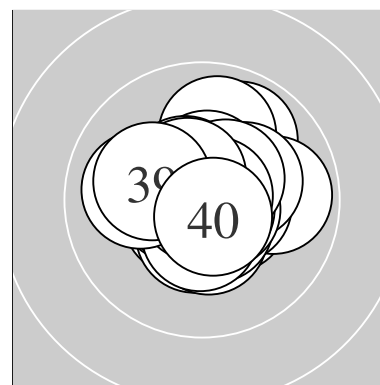

Serie 1:
 10.6 * 9.9 ↗ 10.5 * 10.4 * 10.9 *
 9.9 ↑ 10.7 * 10.5 * 10.6 * 10.5 *
 beste Teiler 18.6 (5.) 74.7 (7.) 87.4 (1.)
 Trefferlage 0.68 mm rechts, 0.69 mm hoch
 Streuwert 0.82, horizontal: 0.54, vertikal: 1.03

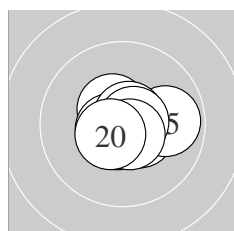

Serie 2:
 10.8 * 10.5 * 10.5 * 10.6 * 9.9 →
 10.7 * 10.7 * 10.7 * 10.6 * 10.6 *
 beste Teiler 41.1 (11.) 60.4 (16.) 70.6 (18.)
 Trefferlage 0.27 mm rechts, 0.14 mm tief
 Streuwert 0.85, horizontal: 1.07, vertikal: 0.56

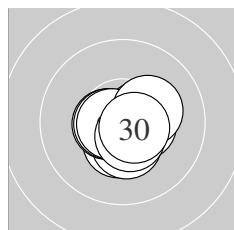

Serie 3:
 10.4 * 10.5 * 10.4 * 10.6 * 10.5 *
 10.6 * 10.7 * 10.3 * 10.5 * 10.6 *
 beste Teiler 69.2 (27.) 82.2 (30.) 86.8 (26.)
 Trefferlage 0.25 mm rechts, 0.33 mm tief
 Streuwert 0.80, horizontal: 0.91, vertikal: 0.67

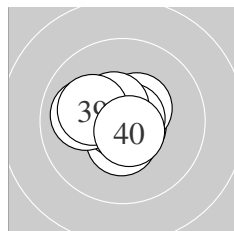

Serie 4:
 10.7 * 10.5 * 10.5 * 10.8 * 10.9 *
 10.0 ← 10.5 * 10.5 * 10.1 ↖ 10.6 *
 beste Teiler 22.8 (35.) 47.7 (34.) 61.5 (31.)
 Trefferlage 0.36 mm links, 0.12 mm hoch
 Streuwert 0.90, horizontal: 1.07, vertikal: 0.70

QF – Schütze hat sich fürs Finale qualifiziert

Unterschrift des Schuetzen

Meyton Elektronik

Ergebnis: **413.2** (394)
 Serien: 102.5 103.5 103.0 104.2
 Zaehler: 34 6 0 0 0 0 0 0 0 0
 Innenzehner: 29
 weiteste: 448 (28), 403 (2), 334 (36)
 beste Teiler 11.4 (37.) 31.0 (6.) 39.9 (21.)
 Trefferlage 0.35 mm links, 0.21 mm tief
 Streuwert 1.28, horizontal: 1.50, vertikal: 1.01

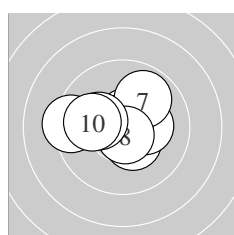
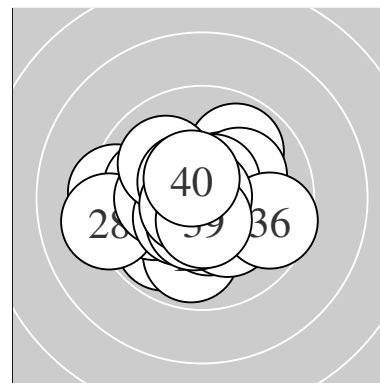

Serie 1:
 10.4 * 9.3 ← 10.3 * 10.3 * 10.6 *
 10.8 * 9.9 ↗ 10.7 * 10.2 * 10.0 ←
 beste Teiler 31.0 (6.) 64.5 (8.) 83.8 (5.)
 Trefferlage 0.23 mm links, 0.36 mm hoch
 Streuwert 1.48, horizontal: 1.90, vertikal: 0.88

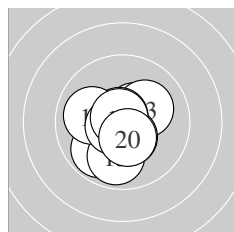

Serie 2:
 9.9 ↙ 10.5 * 10.1 ↗ 10.5 * 9.9 ↓
 10.7 * 10.0 ← 10.7 * 10.8 * 10.4 *
 beste Teiler 45.0 (19.) 53.3 (16.) 74.7 (18.)
 Trefferlage 0.23 mm links, 0.41 mm tief
 Streuwert 1.25, horizontal: 1.22, vertikal: 1.28

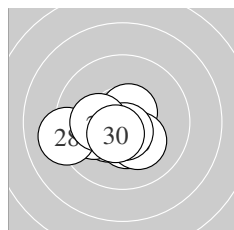

Serie 3:
 10.8 * 10.4 * 10.4 * 10.6 * 10.0 ←
 10.2 * 10.7 * 9.2 ← 10.2 * 10.5 *
 beste Teiler 39.9 (21.) 75.3 (27.) 87.6 (24.)
 Trefferlage 0.76 mm links, 0.61 mm tief
 Streuwert 1.28, horizontal: 1.66, vertikal: 0.71

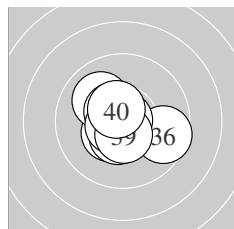

Serie 4:
 10.4 * 10.7 * 10.0 ↘ 10.5 * 10.5 *
 9.6 → 10.9 * 10.6 * 10.5 * 10.5 *
 beste Teiler 11.4 (37.) 56.3 (32.) 76.9 (38.)
 Trefferlage 0.18 mm links, 0.17 mm tief
 Streuwert 1.14, horizontal: 1.29, vertikal: 0.97

Unterschrift des Schuetzen

Meyton Elektronik

Ergebnis: **412.4** (394)
 Serien: 101.4 104.8 103.4 102.8
 Zaehler: 34 6 0 0 0 0 0 0 0 0
 Innenzehner: 31
 weiteste: 437 (2), 378 (3), 315 (38)
 beste Teiler 32.5 (24.) 39.0 (16.) 41.5 (4.)
 Trefferlage 0.27 mm rechts, 0.27 mm tief
 Streuwert 1.28, horizontal: 1.43, vertikal: 1.10

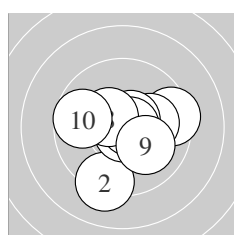
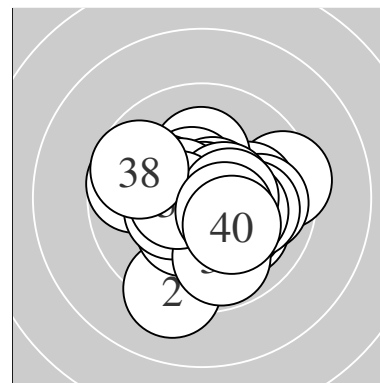

Serie 1:
 10.4 * 9.2 ↓ 9.4 → 10.8 * 10.1 →
 10.6 * 10.7 * 10.4 * 10.1 ↘ 9.7 ←
 beste Teiler 41.5 (4.) 55.3 (7.) 83.5 (6.)
 Trefferlage 0.41 mm rechts, 0.37 mm tief
 Streuwert 1.73, horizontal: 1.92, vertikal: 1.53

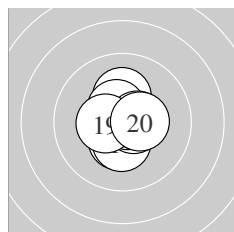

Serie 2:
 10.2 * 10.4 * 10.7 * 10.3 * 10.6 *
 10.8 * 10.5 * 10.5 * 10.4 * 10.4 *
 beste Teiler 39.0 (16.) 55.6 (13.) 85.3 (15.)
 Trefferlage 0.18 mm rechts, 0.02 mm hoch
 Streuwert 0.91, horizontal: 0.81, vertikal: 1.00

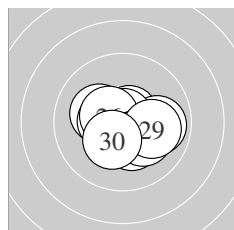

Serie 3:
 10.2 * 10.7 * 9.9 → 10.8 * 10.5 *
 10.5 * 10.3 * 10.2 * 10.0 → 10.3 *
 beste Teiler 32.5 (24.) 72.9 (22.) 114.9 (26.)
 Trefferlage 0.28 mm rechts, 0.25 mm tief
 Streuwert 1.21, horizontal: 1.51, vertikal: 0.81

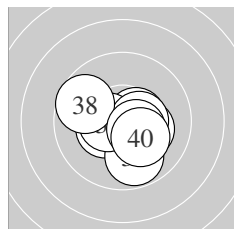

Serie 4:
 10.5 * 10.2 * 10.6 * 10.4 * 9.8 ↓
 10.5 * 10.4 * 9.7 ↙ 10.5 * 10.2 *
 beste Teiler 91.1 (33.) 105.6 (31.) 112.3 (36.)
 Trefferlage 0.20 mm rechts, 0.50 mm tief
 Streuwert 1.29, horizontal: 1.49, vertikal: 1.04

Unterschrift des Schuetzen

Meyton Elektronik

Ergebnis: **409.8** (392)
 Serien: 102.8 103.9 101.7 101.4
 Zaehler: 32 8 0 0 0 0 0 0 0 0
 Innenzehner: 24
 weiteste: 465 (32), 447 (1), 387 (7)
 beste Teiler 12.3 (31.) 41.6 (9.) 56.2 (20.)
 Trefferlage 0.45 mm links, 0.35 mm hoch
 Streuwert 1.42, horizontal: 1.59, vertikal: 1.23

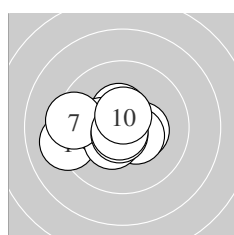
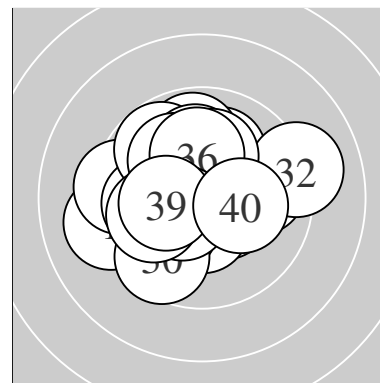

Serie 1:
 9.2 ← 10.5 * 10.4 * 10.5 * 10.3 *
 10.4 * 9.4 ← 10.7 * 10.8 * 10.6 *
 beste Teiler 41.6 (9.) 62.2 (8.) 92.1 (10.)
 Trefferlage 0.88 mm links, 0.13 mm tief
 Streuwert 1.46, horizontal: 1.90, vertikal: 0.81

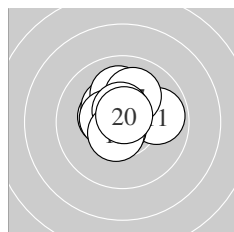

Serie 2:
 9.9 → 10.4 * 10.7 * 10.3 * 10.1 ↑
 10.5 * 10.1 ↑ 10.6 * 10.6 * 10.7 *
 beste Teiler 56.2 (20.) 64.6 (13.) 92.5 (18.)
 Trefferlage 0.13 mm links, 0.67 mm hoch
 Streuwert 1.08, horizontal: 1.17, vertikal: 0.98

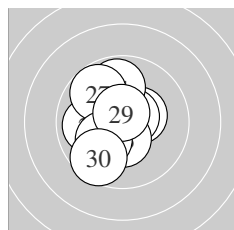

Serie 3:
 10.4 * 10.6 * 10.4 * 9.8 ↑ 10.4 *
 9.9 ← 9.8 ↘ 10.1 ↙ 10.7 * 9.6 ↘
 beste Teiler 73.6 (29.) 79.3 (22.) 132.0 (23.)
 Trefferlage 0.78 mm links, 0.13 mm hoch
 Streuwert 1.48, horizontal: 1.25, vertikal: 1.67

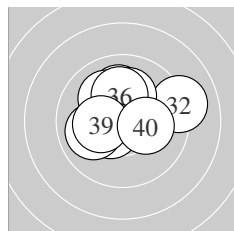

Serie 4:
 10.9 * 9.1 → 10.1 ↑ 10.1 ↘ 10.1 ↑
 10.1 ↑ 10.5 * 10.0 ← 10.3 * 10.2 *
 beste Teiler 12.3 (31.) 117.6 (37.) 172.8 (39.)
 Trefferlage 0.01 mm links, 0.73 mm hoch
 Streuwert 1.64, horizontal: 1.95, vertikal: 1.24

Unterschrift des Schuetzen

Meyton Elektronik

Ergebnis: **414.5** (395)
 Serien: 103.5 103.0 103.6 104.4
 Zaehler: 35 5 0 0 0 0 0 0 0 0
 Innenzehner: 29
 weiteste: 307 (30), 288 (25), 285 (6)
 beste Teiler 14.0 (8.) 15.1 (22.) 15.6 (33.)
 Trefferlage 0.46 mm rechts, 0.07 mm tief
 Streuwert 1.13, horizontal: 1.15, vertikal: 1.12

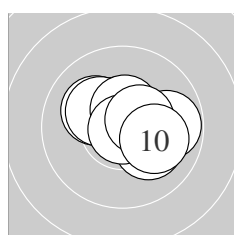
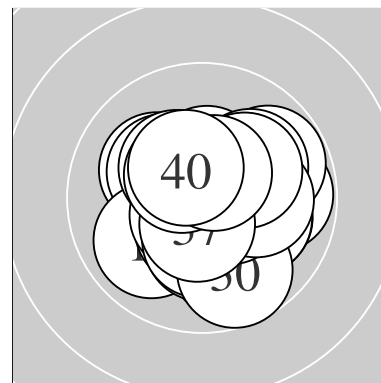

Serie 1:
 10.8 * 10.1 ↘ 10.1 ↖ 10.5 * 10.2 *
 9.8 → 10.5 * 10.9 * 10.5 * 10.1 →
 beste Teiler 14.0 (8.) 45.2 (1.) 105.7 (4.)
 Trefferlage 0.43 mm rechts, 0.32 mm hoch
 Streuwert 1.19, horizontal: 1.48, vertikal: 0.81

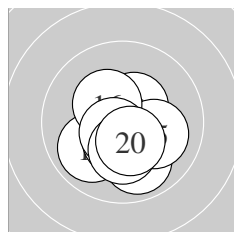

Serie 2:
 10.5 * 9.9 ↙ 9.9 ↘ 10.5 * 10.1 →
 10.3 * 10.6 * 10.6 * 10.2 * 10.4 *
 beste Teiler 87.2 (18.) 97.4 (17.) 122.2 (11.)
 Trefferlage 0.00 mm , 0.84 mm tief
 Streuwert 1.13, horizontal: 1.12, vertikal: 1.14

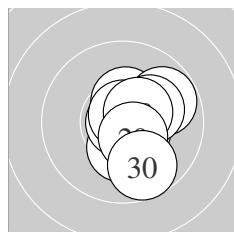

Serie 3:
 10.3 * 10.9 * 10.5 * 10.4 * 9.8 ↗
 10.8 * 10.2 * 10.5 * 10.5 * 9.7 ↘
 beste Teiler 15.1 (22.) 48.0 (26.) 103.4 (23.)
 Trefferlage 0.81 mm rechts, 0.13 mm tief
 Streuwert 1.14, horizontal: 0.88, vertikal: 1.35

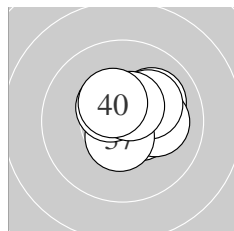

Serie 4:
 10.5 * 10.1 ↗ 10.9 * 10.7 * 10.1 →
 10.2 * 10.5 * 10.5 * 10.5 * 10.4 *
 beste Teiler 15.6 (33.) 57.4 (34.) 102.7 (37.)
 Trefferlage 0.59 mm rechts, 0.35 mm hoch
 Streuwert 0.93, horizontal: 1.05, vertikal: 0.79

Unterschrift des Schuetzen

Meyton Elektronik

Ergebnis: **417.7** (398)^{QF}
 Serien: 102.5 105.2 105.0 105.0
 Zaehler: 38 2 0 0 0 0 0 0 0 0
 Innenzehner: 34
 weiteste: 269 (2), 255 (3), 246 (30)
 beste Teiler 8.4 (26.) 31.0 (22.) 32.0 (18.)
 Trefferlage 0.25 mm links, 0.18 mm hoch
 Streuwert 1.00, horizontal: 1.04, vertikal: 0.96

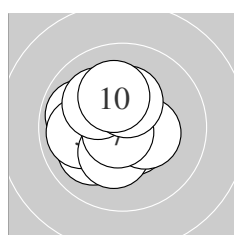
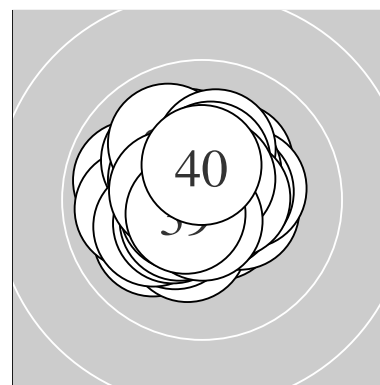

Serie 1:
 10.0 ↙ 9.9 ← 9.9 ← 10.6 * 10.3 *
 10.4 * 10.8 * 10.1 ↘ 10.3 * 10.2 *
 beste Teiler 42.4 (7.) 98.0 (4.) 144.8 (6.)
 Trefferlage 0.76 mm links, 0.10 mm hoch
 Streuwert 1.30, horizontal: 1.34, vertikal: 1.25

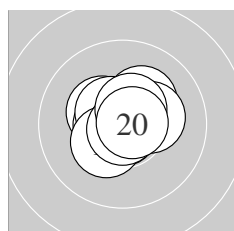

Serie 2:
 10.4 * 10.6 * 10.5 * 10.2 * 10.8 *
 10.3 * 10.4 * 10.8 * 10.5 * 10.7 *
 beste Teiler 32.0 (18.) 38.2 (15.) 60.6 (20.)
 Trefferlage 0.00 mm , 0.24 mm hoch
 Streuwert 0.87, horizontal: 0.98, vertikal: 0.74

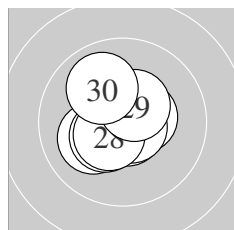

Serie 3:
 10.7 * 10.8 * 10.1 ↙ 10.4 * 10.5 *
 10.9 * 10.7 * 10.5 * 10.4 * 10.0 ↘
 beste Teiler 8.4 (26.) 31.0 (22.) 57.3 (21.)
 Trefferlage 0.20 mm links, 0.00 mm
 Streuwert 0.98, horizontal: 0.99, vertikal: 0.96

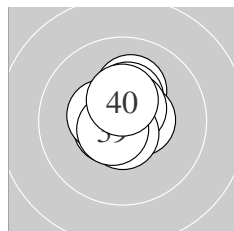

Serie 4:
 10.7 * 10.6 * 10.4 * 10.2 * 10.4 *
 10.5 * 10.6 * 10.6 * 10.6 * 10.4 *
 beste Teiler 62.9 (31.) 78.0 (38.) 80.9 (39.)
 Trefferlage 0.07 mm links, 0.37 mm hoch
 Streuwert 0.83, horizontal: 0.71, vertikal: 0.94

QF – Schütze hat sich fürs Finale qualifiziert

Unterschrift des Schuetzen

Meyton Elektronik

Ergebnis: **412.2** (393)
 Serien: 102.6 103.0 103.1 103.5
 Zaehler: 33 7 0 0 0 0 0 0 0 0
 Innenzehner: 29
 weiteste: 390 (8), 381 (35), 320 (18)
 beste Teiler 13.4 (17.) 44.3 (32.) 51.1 (20.)
 Trefferlage 0.11 mm links, 0.25 mm tief
 Streuwert 1.31, horizontal: 1.51, vertikal: 1.07

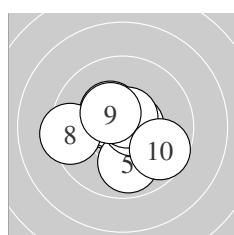
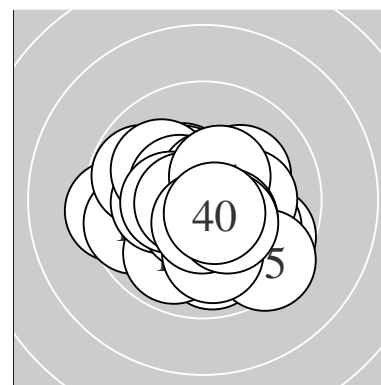

Serie 1:
 10.6 * 10.4 * 10.5 * 10.5 * 9.9 ↓
 10.6 * 10.6 * 9.4 ← 10.4 * 9.7 ↘
 beste Teiler 79.6 (7.) 80.7 (1.) 80.7 (6.)
 Trefferlage 0.22 mm links, 0.06 mm tief
 Streuwert 1.49, horizontal: 1.72, vertikal: 1.22

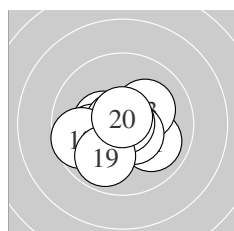

Serie 2:
 10.0 ↘ 10.4 * 10.2 * 10.5 * 10.0 ←
 10.7 * 10.9 * 9.7 ← 9.9 ✓ 10.7 *
 beste Teiler 13.4 (17.) 51.1 (20.) 51.4 (16.)
 Trefferlage 0.37 mm links, 0.41 mm tief
 Streuwert 1.36, horizontal: 1.64, vertikal: 1.00

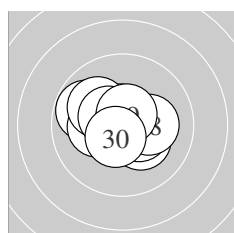

Serie 3:
 10.6 * 10.3 * 9.8 ↖ 10.4 * 10.2 *
 10.0 ↖ 10.5 * 10.2 * 10.6 * 10.5 *
 beste Teiler 81.0 (21.) 84.1 (29.) 101.3 (30.)
 Trefferlage 0.33 mm links, 0.21 mm hoch
 Streuwert 1.24, horizontal: 1.54, vertikal: 0.83

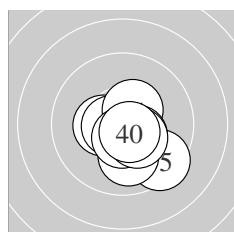

Serie 4:
 10.4 * 10.8 * 10.6 * 10.4 * 9.4 ↘
 10.0 ↓ 10.5 * 10.4 * 10.4 * 10.6 *
 beste Teiler 44.3 (32.) 77.9 (40.) 81.3 (33.)
 Trefferlage 0.47 mm rechts, 0.75 mm tief
 Streuwert 1.12, horizontal: 1.13, vertikal: 1.11

Unterschrift des Schuetzen

Meyton Elektronik

Ergebnis: **415.1** (395)
 Serien: 104.1 105.2 101.3 104.5
 Zaehler: 35 5 0 0 0 0 0 0 0 0
 Innenzehner: 30
 weiteste: 354 (23), 352 (22), 298 (33)
 beste Teiler 32.6 (37.) 46.8 (20.) 48.0 (36.)
 Trefferlage 0.27 mm rechts, 0.07 mm tief
 Streuwert 1.16, horizontal: 1.19, vertikal: 1.14

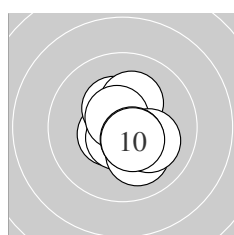
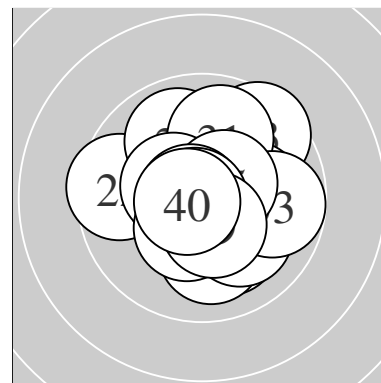

Serie 1:
 10.6 * 10.5 * 10.4 * 10.6 * 10.2 *
 10.6 * 10.1 ↘ 10.1 ↗ 10.5 * 10.5 *
 beste Teiler 79.7 (6.) 83.1 (4.) 84.4 (1.)
 Trefferlage 0.30 mm rechts, 0.13 mm tief
 Streuwert 1.02, horizontal: 0.87, vertikal: 1.16

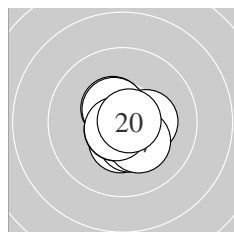

Serie 2:
 10.5 * 10.6 * 10.4 * 10.4 * 10.3 *
 10.7 * 10.3 * 10.5 * 10.7 * 10.8 *
 beste Teiler 46.8 (20.) 65.0 (19.) 67.8 (16.)
 Trefferlage 0.12 mm rechts, 0.37 mm tief
 Streuwert 0.83, horizontal: 0.79, vertikal: 0.86

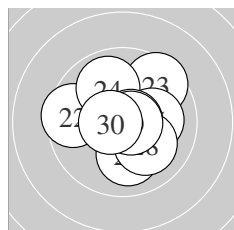

Serie 3:
 10.2 * 9.5 ← 9.5 ↗ 9.9 ↖ 10.1 →
 10.7 * 10.0 ↓ 10.1 ↘ 10.7 * 10.6 *
 beste Teiler 58.3 (26.) 58.4 (29.) 86.0 (30.)
 Trefferlage 0.41 mm rechts, 0.18 mm hoch
 Streuwert 1.65, horizontal: 1.81, vertikal: 1.49

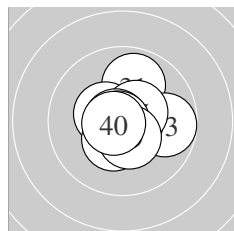

Serie 4:
 9.9 ↗ 10.7 * 9.8 → 10.4 * 10.5 *
 10.8 * 10.8 * 10.4 * 10.5 * 10.7 *
 beste Teiler 32.6 (37.) 48.0 (36.) 65.0 (40.)
 Trefferlage 0.23 mm rechts, 0.00 mm
 Streuwert 1.13, horizontal: 1.19, vertikal: 1.07

Unterschrift des Schuetzen

Ergebnis: **412.1** (395)
 Serien: 102.3 104.0 101.9 103.9
 Zaehler: 35 5 0 0 0 0 0 0 0 0
 Innenzehner: 29
 weiteste: 367 (26), 362 (10), 316 (19)
 beste Teiler 46.0 (17.) 46.6 (33.) 58.1 (34.)
 Trefferlage 0.07 mm links, 0.62 mm hoch
 Streuwert 1.24, horizontal: 1.27, vertikal: 1.21

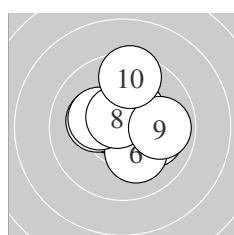
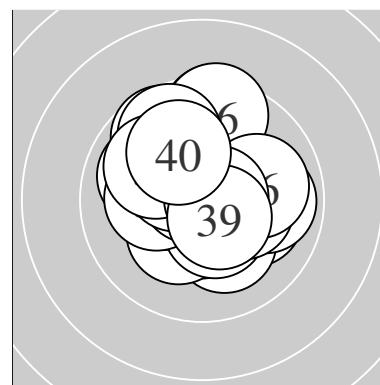

Serie 1:
 10.4 * 10.6 * 10.6 * 10.2 * 10.1 →
 10.2 * 10.2 * 10.6 * 9.9 → 9.5 ↑
 beste Teiler 78.1 (3.) 82.7 (8.) 84.1 (2.)
 Trefferlage 0.29 mm rechts, 0.50 mm hoch
 Streuwert 1.42, horizontal: 1.48, vertikal: 1.36

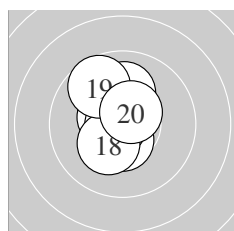

Serie 2:
 10.7 * 10.4 * 10.5 * 10.5 * 10.5 *
 10.1 ↑ 10.8 * 10.3 * 9.7 ↘ 10.5 *
 beste Teiler 46.0 (17.) 60.4 (11.) 104.8 (20.)
 Trefferlage 0.48 mm links, 0.66 mm hoch
 Streuwert 1.03, horizontal: 0.68, vertikal: 1.29

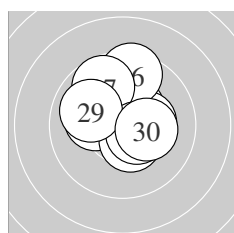

Serie 3:
 10.5 * 10.4 * 10.2 * 10.3 * 10.5 *
 9.5 ↑ 9.7 ↘ 10.5 * 10.0 ↖ 10.3 *
 beste Teiler 107.2 (21.) 116.3 (28.) 125.2 (25.)
 Trefferlage 0.05 mm rechts, 0.82 mm hoch
 Streuwert 1.45, horizontal: 1.44, vertikal: 1.47

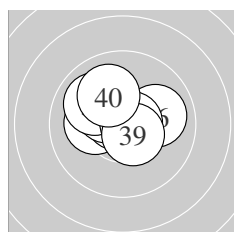

Serie 4:
 10.2 * 10.6 * 10.8 * 10.7 * 10.4 *
 10.0 → 10.0 ↖ 10.7 * 10.5 * 10.0 ↘
 beste Teiler 46.6 (33.) 58.1 (34.) 61.6 (38.)
 Trefferlage 0.15 mm links, 0.50 mm hoch
 Streuwert 1.13, horizontal: 1.39, vertikal: 0.79

Unterschrift des Schuetzen

Meyton Elektronik

Ergebnis: **413.8** (398)
 Serien: 103.1 103.7 102.8 104.2
 Zaehler: 38 2 0 0 0 0 0 0 0 0
 Innenzehner: 31
 weiteste: 379 (17), 287 (23), 246 (10)
 beste Teiler 17.0 (21.) 20.0 (15.) 43.3 (34.)
 Trefferlage 0.07 mm links, 0.02 mm hoch
 Streuwert 1.22, horizontal: 1.34, vertikal: 1.08

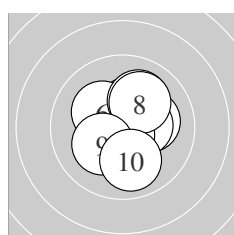
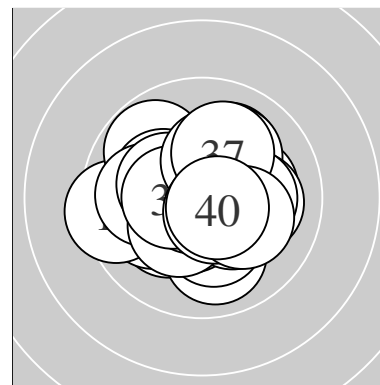

Serie 1:
 10.8 * 10.4 * 10.2 * 10.4 * 10.7 *
 10.2 * 10.1 ↗ 10.1 ↗ 10.2 * 10.0 ↓
 beste Teiler 45.8 (1.) 58.5 (5.) 142.6 (4.)
 Trefferlage 0.40 mm rechts, 0.21 mm hoch
 Streuwert 1.28, horizontal: 1.15, vertikal: 1.40

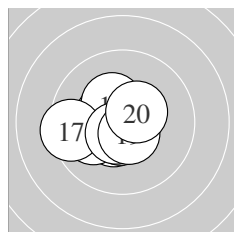

Serie 2:
 10.5 * 10.4 * 10.0 ← 10.6 * 10.9 *
 10.3 * 9.4 ← 10.6 * 10.6 * 10.4 *
 beste Teiler 20.0 (15.) 90.0 (14.) 92.7 (18.)
 Trefferlage 0.75 mm links, 0.21 mm tief
 Streuwert 1.13, horizontal: 1.36, vertikal: 0.84

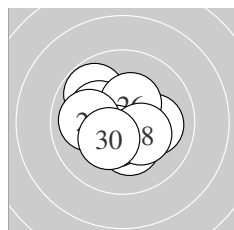

Serie 3:
 10.9 * 10.3 * 9.8 ↘ 10.2 * 10.1 →
 10.4 * 10.5 * 10.3 * 10.0 ← 10.3 *
 beste Teiler 17.0 (21.) 114.4 (27.) 146.9 (26.)
 Trefferlage 0.31 mm links, 0.07 mm tief
 Streuwert 1.35, horizontal: 1.50, vertikal: 1.17

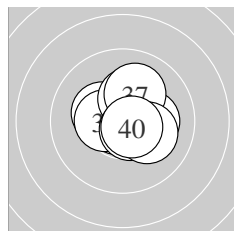

Serie 4:
 10.2 * 10.3 * 10.7 * 10.8 * 10.4 *
 10.3 * 10.1 ↗ 10.6 * 10.2 * 10.6 *
 beste Teiler 43.3 (34.) 74.6 (33.) 79.6 (40.)
 Trefferlage 0.36 mm rechts, 0.16 mm hoch
 Streuwert 1.04, horizontal: 1.13, vertikal: 0.95

Unterschrift des Schuetzen

Meyton Elektronik

Ergebnis: **415.5** (396)^{QF}
 Serien: 104.1 103.7 103.5 104.2
 Zaehler: 36 4 0 0 0 0 0 0 0 0
 Innenzehner: 31
 weiteste: 342 (21), 267 (1), 265 (28)
 beste Teiler 10.0 (4.) 24.5 (38.) 60.8 (27.)
 Trefferlage 0.05 mm rechts, 0.33 mm hoch
 Streuwert 1.12, horizontal: 1.28, vertikal: 0.93

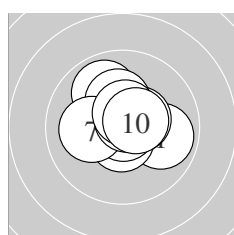
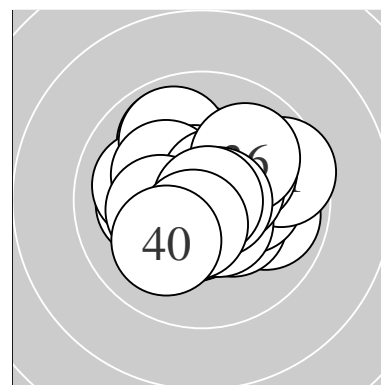

Serie 1:
 9.9 → 10.6 * 9.9 ↖ 10.9 * 10.5 *
 10.3 * 10.1 ← 10.7 * 10.6 * 10.6 *
 beste Teiler 10.0 (4.) 62.2 (8.) 80.3 (2.)
 Trefferlage 0.13 mm rechts, 0.48 mm hoch
 Streuwert 1.14, horizontal: 1.28, vertikal: 0.98

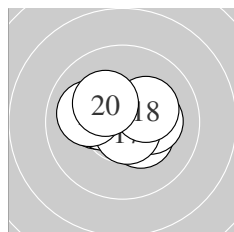

Serie 2:
 10.3 * 10.6 * 10.3 * 10.4 * 10.7 *
 10.2 * 10.7 * 10.2 * 10.0 ← 10.3 *
 beste Teiler 61.4 (15.) 69.7 (17.) 81.7 (12.)
 Trefferlage 0.16 mm links, 0.26 mm hoch
 Streuwert 1.13, horizontal: 1.46, vertikal: 0.64

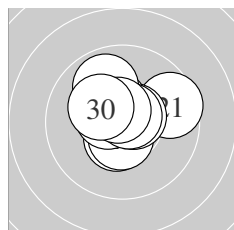

Serie 3:
 9.6 → 10.5 * 10.5 * 10.6 * 10.4 *
 10.5 * 10.7 * 9.9 ↖ 10.6 * 10.2 *
 beste Teiler 60.8 (27.) 83.6 (24.) 86.7 (29.)
 Trefferlage 0.06 mm links, 0.57 mm hoch
 Streuwert 1.20, horizontal: 1.34, vertikal: 1.04

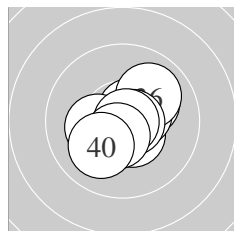

Serie 4:
 10.6 * 10.3 * 10.5 * 10.1 ↗ 10.5 *
 10.0 ↗ 10.7 * 10.9 * 10.5 * 10.1 ↙
 beste Teiler 24.5 (38.) 63.6 (37.) 86.0 (31.)
 Trefferlage 0.30 mm rechts, 0.00 mm
 Streuwert 1.12, horizontal: 1.18, vertikal: 1.05

QF – Schütze hat sich fürs Finale qualifiziert

Unterschrift des Schuetzen

Ergebnis: **419.4** (399)^{QF}
 Serien: 105.4 105.7 104.5 103.8
 Zaehler: 39 1 0 0 0 0 0 0 0 0
 Innenzehner: 36
 weiteste: 251 (29), 237 (38), 221 (12)
 beste Teiler 12.2 (7.) 14.2 (11.) 42.9 (19.)
 Trefferlage 0.03 mm links, 0.54 mm hoch
 Streuwert 0.86, horizontal: 0.90, vertikal: 0.81

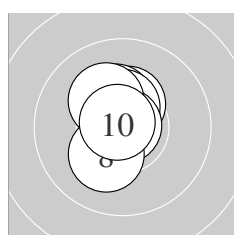
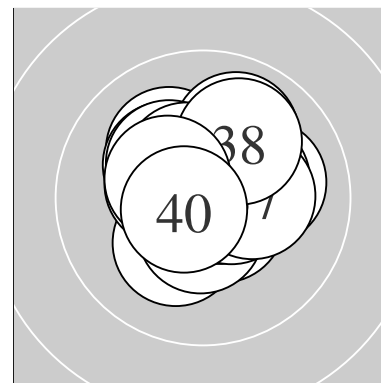

Serie 1:
 10.7 * 10.4 * 10.3 * 10.7 * 10.7 *
 10.5 * 10.9 * 10.2 * 10.2 * 10.8 *
 beste Teiler 12.2 (7.) 43.1 (10.) 69.3 (4.)
 Trefferlage 0.28 mm links, 0.64 mm hoch
 Streuwert 0.73, horizontal: 0.43, vertikal: 0.94

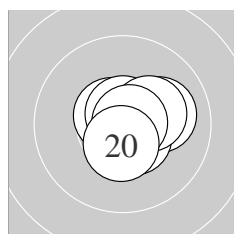

Serie 2:
 10.9 * 10.1 → 10.6 * 10.7 * 10.6 *
 10.5 * 10.7 * 10.3 * 10.8 * 10.5 *
 beste Teiler 14.2 (11.) 42.9 (19.) 55.3 (14.)
 Trefferlage 0.44 mm rechts, 0.00 mm
 Streuwert 0.76, horizontal: 0.84, vertikal: 0.68

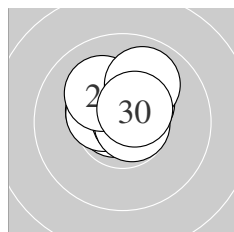

Serie 3:
 10.4 * 10.8 * 10.4 * 10.5 * 10.8 *
 10.4 * 10.7 * 10.1 ↘ 9.9 ↗ 10.5 *
 beste Teiler 44.2 (25.) 48.7 (22.) 56.8 (27.)
 Trefferlage 0.10 mm links, 0.84 mm hoch
 Streuwert 0.84, horizontal: 0.93, vertikal: 0.74

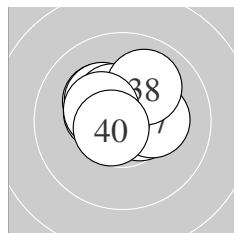

Serie 4:
 10.5 * 10.4 * 10.2 * 10.3 * 10.7 *
 10.4 * 10.3 * 10.0 ↗ 10.4 * 10.6 *
 beste Teiler 55.3 (35.) 79.4 (40.) 101.5 (31.)
 Trefferlage 0.18 mm links, 0.66 mm hoch
 Streuwert 0.99, horizontal: 1.19, vertikal: 0.73

QF – Schütze hat sich fürs Finale qualifiziert

Unterschrift des Schuetzen

Meyton Elektronik

Ergebnis: **401.7** (385)
 Serien: 100.0 99.8 100.1 101.8
 Zaehler: 25 15 0 0 0 0 0 0 0 0
 Innenzehner: 17
 weiteste: 491 (10), 484 (26), 377 (16)
 beste Teiler 21.4 (4.) 23.3 (33.) 52.4 (28.)
 Trefferlage 0.20 mm rechts, 0.08 mm tief
 Streuwert 1.79, horizontal: 1.90, vertikal: 1.68

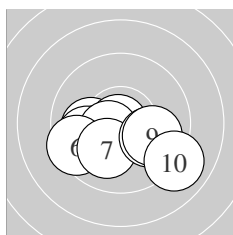
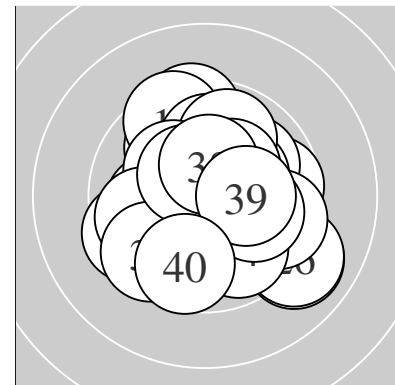

Serie 1:
 10.0 ← 10.2 * 9.9 ← 10.9 * 10.5 *
 9.5 ← 10.1 ↙ 10.0 → 9.9 → 9.0 ↘
 beste Teiler 21.4 (4.) 106.8 (5.) 182.6 (2.)
 Trefferlage 0.32 mm links, 1.12 mm tief
 Streuwert 1.79, horizontal: 2.40, vertikal: 0.81

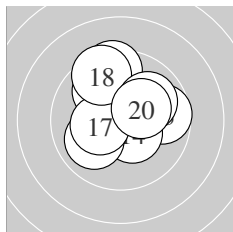

Serie 2:
 9.9 ↖ 10.4 * 9.7 → 10.4 * 10.0 ↙
 9.4 ↑ 10.3 * 9.5 ↘ 10.0 ↗ 10.2 *
 beste Teiler 132.3 (14.) 140.8 (12.) 158.1 (17.)
 Trefferlage 0.12 mm rechts, 1.04 mm hoch
 Streuwert 1.74, horizontal: 1.76, vertikal: 1.72

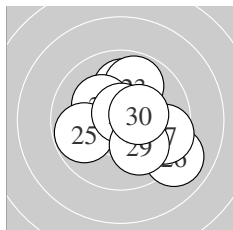

Serie 3:
 10.0 ↑ 10.5 * 9.9 ↑ 10.2 * 9.8 ←
 9.0 ↘ 9.6 → 10.7 * 10.0 ↘ 10.4 *
 beste Teiler 52.4 (28.) 106.4 (22.) 142.3 (30.)
 Trefferlage 0.65 mm rechts, 0.13 mm hoch
 Streuwert 1.89, horizontal: 2.02, vertikal: 1.75

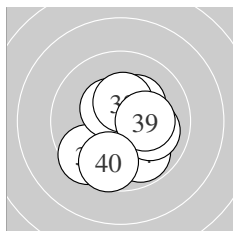

Serie 4:
 9.6 ↙ 10.4 * 10.9 * 9.8 ↘ 10.5 *
 10.0 → 10.3 * 10.4 * 10.2 * 9.7 ↓
 beste Teiler 23.3 (33.) 125.6 (35.) 126.2 (32.)
 Trefferlage 0.36 mm rechts, 0.38 mm tief
 Streuwert 1.57, horizontal: 1.44, vertikal: 1.69

Unterschrift des Schuetzen

Ergebnis: **412.9** (394)
 Serien: 103.0 104.7 103.5 101.7
 Zaehler: 34 6 0 0 0 0 0 0 0 0
 Innenzehner: 24
 weiteste: 397 (15), 379 (33), 313 (6)
 beste Teiler 16.4 (13.) 24.7 (23.) 44.1 (2.)
 Trefferlage 0.14 mm rechts, 0.28 mm hoch
 Streuwert 1.29, horizontal: 1.31, vertikal: 1.28

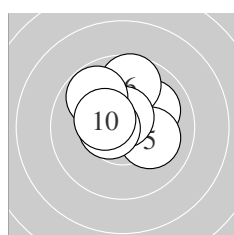
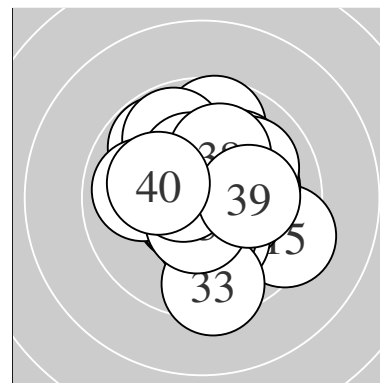

Serie 1:
 10.8 * 10.8 * 10.1 ↑ 10.0 ↗ 10.1 ↘
 9.7 ↑ 10.7 * 10.6 * 9.8 ↖ 10.4 *
 beste Teiler 44.1 (2.) 45.0 (1.) 73.1 (7.)
 Trefferlage 0.00 mm , 0.99 mm hoch
 Streuwert 1.21, horizontal: 1.26, vertikal: 1.16

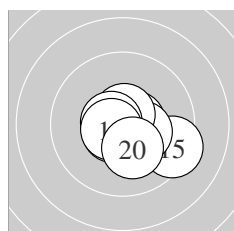

Serie 2:
 10.6 * 10.6 * 10.9 * 10.7 * 9.4 ↘
 10.4 * 10.7 * 10.6 * 10.6 * 10.2 *
 beste Teiler 16.4 (13.) 54.2 (14.) 72.0 (17.)
 Trefferlage 0.43 mm rechts, 0.43 mm tief
 Streuwert 1.09, horizontal: 1.34, vertikal: 0.78

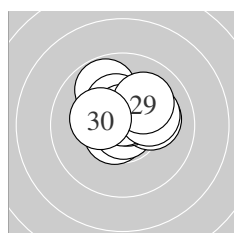

Serie 3:
 9.8 ↖ 10.6 * 10.9 * 10.1 → 10.6 *
 10.3 * 10.7 * 10.1 → 10.1 ↗ 10.3 *
 beste Teiler 24.7 (23.) 73.1 (27.) 81.8 (25.)
 Trefferlage 0.20 mm rechts, 0.78 mm hoch
 Streuwert 1.11, horizontal: 1.27, vertikal: 0.92

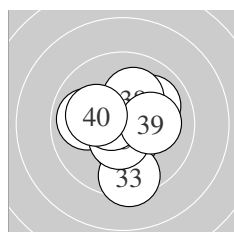

Serie 4:
 10.7 * 10.3 * 9.4 ↓ 9.9 ← 10.5 *
 10.6 * 10.0 ↗ 10.1 ↑ 10.1 → 10.1 ↖
 beste Teiler 65.7 (31.) 88.3 (36.) 107.4 (35.)
 Trefferlage 0.06 mm links, 0.20 mm tief
 Streuwert 1.55, horizontal: 1.50, vertikal: 1.60

Unterschrift des Schuetzen

Meyton Elektronik