

Ergebnis: **413.9** (392)^{QF}
 Serien: 102.8 102.4 105.0 103.7
 Zähler: 32 8 0 0 0 0 0 0 0 0
 Innenzehner: 27
 weiteste: 295 (12), 294 (4), 285 (2)
 beste Teiler 21.5 (14.) 25.7 (29.) 40.6 (6.)
 Trefferlage 0.11 mm links, 0.08 mm hoch
 Streuwert 1.24, horizontal: 1.23, vertikal: 1.25

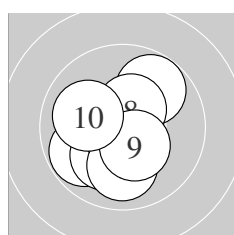

Serie 1:
 10.6 * 9.8 ↙ 10.1 ↗ 9.8 ↗ 10.8 *
 10.8 * 10.0 ↓ 10.5 * 10.4 * 10.0 ↖
 beste Teiler 40.6 (6.) 43.6 (5.) 96.5 (1.)
 Trefferlage 0.41 mm links, 0.32 mm tief
 Streuwert 1.38, horizontal: 1.30, vertikal: 1.46

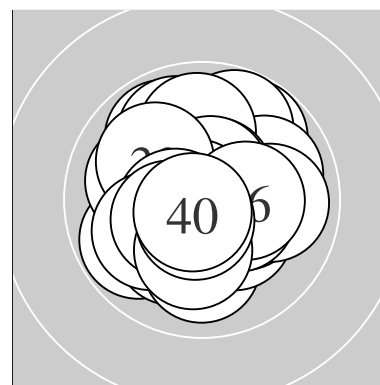
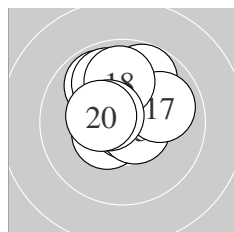

Serie 2:
 10.5 * 9.8 ↗ 9.9 ↖ 10.9 * 10.6 *
 9.9 ↖ 9.9 → 9.9 ↑ 10.6 * 10.4 *
 beste Teiler 21.5 (14.) 87.6 (15.) 98.8 (19.)
 Trefferlage 0.13 mm links, 1.06 mm hoch
 Streuwert 1.30, horizontal: 1.26, vertikal: 1.33

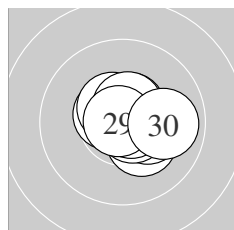

Serie 3:
 10.3 * 10.3 * 10.7 * 10.7 * 10.6 *
 10.5 * 10.5 * 10.6 * 10.9 * 9.9 →
 beste Teiler 25.7 (29.) 55.2 (24.) 72.9 (23.)
 Trefferlage 0.55 mm rechts, 0.11 mm hoch
 Streuwert 0.89, horizontal: 1.05, vertikal: 0.69

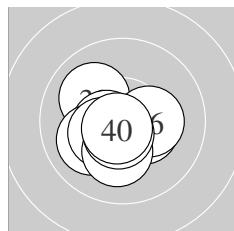

Serie 4:
 10.6 * 10.4 * 10.0 ↖ 10.5 * 10.0 ↙
 10.3 * 10.4 * 10.2 * 10.6 * 10.7 *
 beste Teiler 59.2 (40.) 83.1 (39.) 93.2 (31.)
 Trefferlage 0.46 mm links, 0.50 mm tief
 Streuwert 1.04, horizontal: 1.19, vertikal: 0.86

QF – Schütze hat sich fürs Finale qualifiziert

Unterschrift des Schützen

Meyton Elektronik

Ergebnis: **413.6** (396)
 Serien: 103.2 103.3 102.8 104.3
 Zähler: 36 4 0 0 0 0 0 0 0 0
 Innenzehner: 31
 weiteste: 384 (34), 317 (12), 297 (3)
 beste Teiler 11.4 (11.) 34.0 (35.) 47.0 (40.)
 Trefferlage 0.23 mm rechts, 0.41 mm hoch
 Streuwert 1.20, horizontal: 1.26, vertikal: 1.13

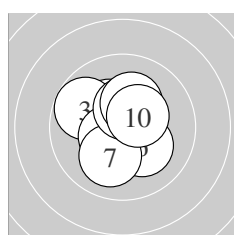
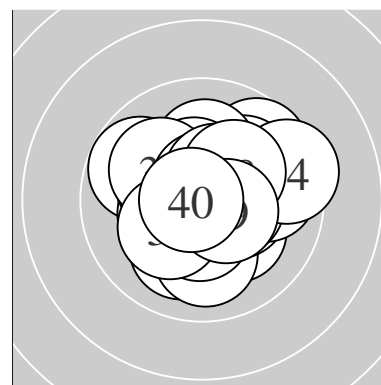

Serie 1:
 10.7 * 10.3 * 9.8 ↖ 10.5 * 10.6 *
 10.2 * 10.1 ↙ 10.4 * 10.2 * 10.4 *
 beste Teiler 53.3 (1.) 100.4 (5.) 114.2 (4.)
 Trefferlage 0.19 mm links, 0.28 mm hoch
 Streuwert 1.25, horizontal: 1.23, vertikal: 1.28

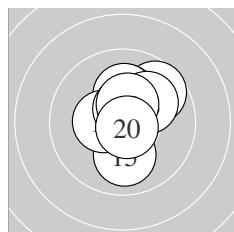

Serie 2:
 10.9 * 9.7 ↗ 10.2 * 10.2 * 10.0 ↓
 10.4 * 10.6 * 10.1 ↗ 10.4 * 10.8 *
 beste Teiler 11.4 (11.) 48.2 (20.) 96.5 (17.)
 Trefferlage 0.38 mm rechts, 0.69 mm hoch
 Streuwert 1.22, horizontal: 1.01, vertikal: 1.39

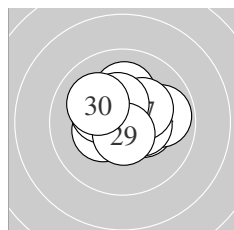

Serie 3:
 10.4 * 10.3 * 10.3 * 9.9 → 10.4 *
 10.1 ↑ 10.3 * 10.4 * 10.6 * 10.1 ↖
 beste Teiler 85.3 (29.) 132.5 (25.) 135.5 (28.)
 Trefferlage 0.20 mm rechts, 0.48 mm hoch
 Streuwert 1.26, horizontal: 1.50, vertikal: 0.96

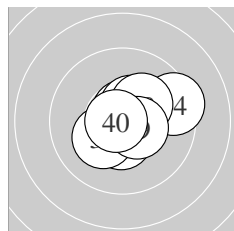

Serie 4:
 10.7 * 10.5 * 10.2 * 9.4 → 10.8 *
 10.7 * 10.5 * 10.2 * 10.5 * 10.8 *
 beste Teiler 34.0 (35.) 47.0 (40.) 70.0 (31.)
 Trefferlage 0.52 mm rechts, 0.19 mm hoch
 Streuwert 1.15, horizontal: 1.34, vertikal: 0.93

Unterschrift des Schützen

Meyton Elektronik

Ergebnis: **413.9** (395)^{QF}
 Serien: 101.5 103.9 104.4 104.1
 Zähler: 35 5 0 0 0 0 0 0 0 0
 Innenzehner: 32
 weiteste: 323 (5), 320 (9), 285 (1)
 beste Teiler 16.2 (4.) 32.3 (16.) 33.6 (19.)
 Trefferlage 0.21 mm rechts, 0.29 mm tief
 Streuwert 1.20, horizontal: 1.13, vertikal: 1.27

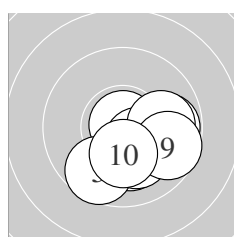
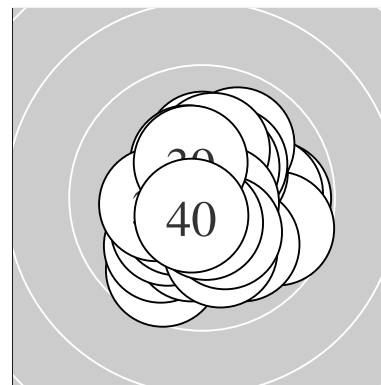

Serie 1:
 9.8 → 10.4 * 10.2 * 10.9 * 9.7 ↙
 10.2 * 10.4 * 9.9 → 9.7 → 10.3 *
 beste Teiler 16.2 (4.) 134.1 (2.) 140.1 (7.)
 Trefferlage 0.98 mm rechts, 1.13 mm tief
 Streuwert 1.24, horizontal: 1.43, vertikal: 1.00

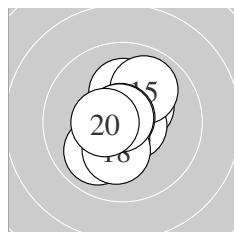

Serie 2:
 10.2 * 10.0 ↘ 10.3 * 10.7 * 9.9 ↗
 10.8 * 10.5 * 10.2 * 10.8 * 10.5 *
 beste Teiler 32.3 (16.) 33.6 (19.) 70.8 (14.)
 Trefferlage 0.07 mm links, 0.05 mm hoch
 Streuwert 1.20, horizontal: 0.95, vertikal: 1.40

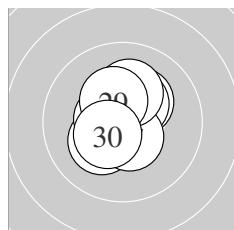

Serie 3:
 10.3 * 10.2 * 10.4 * 10.6 * 10.8 *
 10.7 * 10.5 * 10.2 * 10.3 * 10.4 *
 beste Teiler 44.6 (25.) 57.0 (26.) 100.2 (24.)
 Trefferlage 0.16 mm links, 0.38 mm hoch
 Streuwert 0.98, horizontal: 0.84, vertikal: 1.10

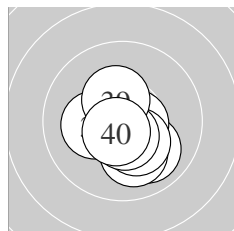

Serie 4:
 10.0 ↘ 10.5 * 10.8 * 10.1 ↘ 10.2 *
 10.6 * 10.3 * 10.6 * 10.4 * 10.6 *
 beste Teiler 38.1 (33.) 81.0 (36.) 81.6 (40.)
 Trefferlage 0.09 mm rechts, 0.47 mm tief
 Streuwert 1.06, horizontal: 0.97, vertikal: 1.15

QF – Schütze hat sich fürs Finale qualifiziert

Unterschrift des Schützen

Meyton Elektronik

Ergebnis: **413.7** (395)^{QF}
 Serien: 101.9 104.0 104.6 103.2
 Zähler: 35 5 0 0 0 0 0 0 0 0
 Innenzehner: 28
 weiteste: 371 (2), 323 (5), 277 (12)
 beste Teiler 20.2 (36.) 37.9 (16.) 40.6 (6.)
 Trefferlage 0.29 mm rechts, 0.36 mm tief
 Streuwert 1.20, horizontal: 1.36, vertikal: 1.01

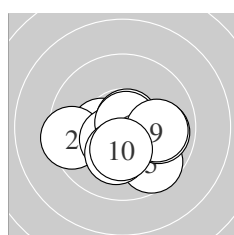
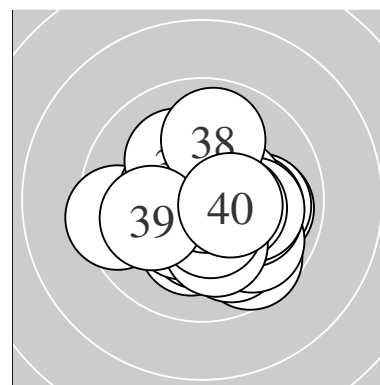

Serie 1:
 10.3 * 9.5 ← 10.7 * 10.5 * 9.7 ↘
 10.8 * 9.9 → 10.2 * 10.0 → 10.3 *
 beste Teiler 40.6 (6.) 58.5 (3.) 120.9 (4.)
 Trefferlage 0.10 mm rechts, 0.75 mm tief
 Streuwert 1.52, horizontal: 1.93, vertikal: 0.97

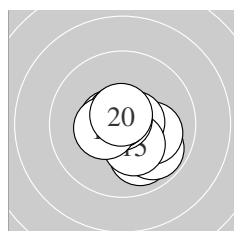

Serie 2:
 10.0 ↘ 9.8 ↘ 10.1 → 10.6 * 10.3 *
 10.8 * 10.6 * 10.7 * 10.4 * 10.7 *
 beste Teiler 37.9 (16.) 60.5 (18.) 67.8 (20.)
 Trefferlage 0.43 mm rechts, 0.43 mm tief
 Streuwert 1.10, horizontal: 1.17, vertikal: 1.02

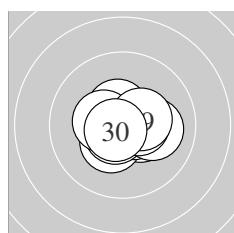

Serie 3:
 10.5 * 10.4 * 10.4 * 10.6 * 10.6 *
 10.1 → 10.5 * 10.4 * 10.4 * 10.7 *
 beste Teiler 62.4 (30.) 76.4 (25.) 84.2 (24.)
 Trefferlage 0.30 mm rechts, 0.12 mm tief
 Streuwert 0.93, horizontal: 1.16, vertikal: 0.61

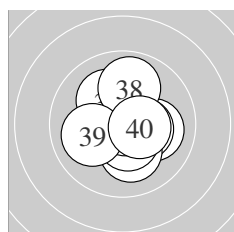

Serie 4:
 10.1 → 10.4 * 10.6 * 10.2 * 10.5 *
 10.9 * 10.1 ↘ 9.9 ↑ 10.0 ← 10.5 *
 beste Teiler 20.2 (36.) 80.8 (33.) 118.2 (35.)
 Trefferlage 0.33 mm rechts, 0.13 mm tief
 Streuwert 1.28, horizontal: 1.23, vertikal: 1.33

QF – Schütze hat sich fürs Finale qualifiziert

Unterschrift des Schützen

Meyton Elektronik

Ergebnis: **413.1** (395)
 Serien: 104.7 103.4 102.9 102.1
 Zähler: 35 5 0 0 0 0 0 0 0 0
 Innenzehner: 32
 weiteste: 422 (17), 298 (39), 285 (21)
 beste Teiler 7.2 (5.) 42.9 (12.) 51.2 (10.)
 Trefferlage 0.06 mm rechts, 0.01 mm hoch
 Streuwert 1.25, horizontal: 1.41, vertikal: 1.08

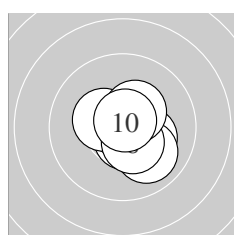
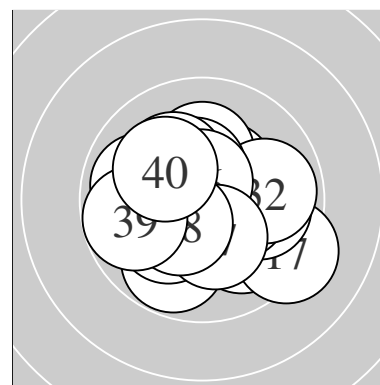

Serie 1:
 10.2 * 10.0 ↘ 10.5 * 10.6 * 10.9 *
 10.6 * 10.4 * 10.4 * 10.4 * 10.7 *
 beste Teiler 7.2 (5.) 51.2 (10.) 82.3 (6.)
 Trefferlage 0.21 mm rechts, 0.14 mm tief
 Streuwert 0.98, horizontal: 1.05, vertikal: 0.91

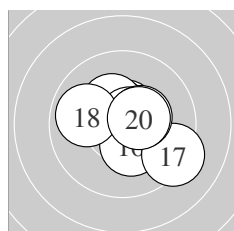

Serie 2:
 10.6 * 10.8 * 10.6 * 10.3 * 10.7 *
 10.3 * 9.3 ↘ 9.9 ← 10.4 * 10.5 *
 beste Teiler 42.9 (12.) 63.1 (15.) 94.3 (11.)
 Trefferlage 0.39 mm rechts, 0.19 mm hoch
 Streuwert 1.37, horizontal: 1.58, vertikal: 1.12

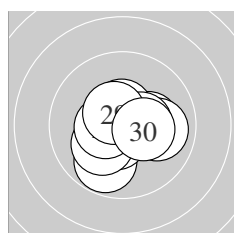

Serie 3:
 9.8 ↙ 10.2 * 10.5 * 10.0 → 10.4 *
 10.5 * 10.2 * 10.5 * 10.5 * 10.3 *
 beste Teiler 104.2 (23.) 105.5 (26.) 106.2 (29.)
 Trefferlage 0.20 mm rechts, 0.34 mm tief
 Streuwert 1.26, horizontal: 1.43, vertikal: 1.07

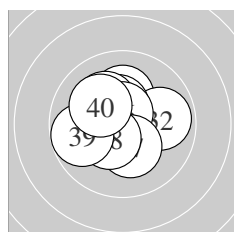

Serie 4:
 10.2 * 9.9 → 10.4 * 10.2 * 10.2 *
 10.6 * 10.3 * 10.4 * 9.8 ← 10.1 ↘
 beste Teiler 78.3 (36.) 133.4 (33.) 135.8 (38.)
 Trefferlage 0.55 mm links, 0.34 mm hoch
 Streuwert 1.38, horizontal: 1.52, vertikal: 1.22

Unterschrift des Schützen

Ergebnis: **409.6** (392)
 Serien: 100.4 102.6 102.9 103.7
 Zähler: 32 8 0 0 0 0 0 0 0 0
 Innenzehner: 24
 weiteste: 369 (7), 347 (19), 344 (5)
 beste Teiler 54.6 (33.) 57.0 (11.) 61.0 (29.)
 Trefferlage 0.28 mm links, 0.17 mm hoch
 Streuwert 1.41, horizontal: 1.73, vertikal: 0.99

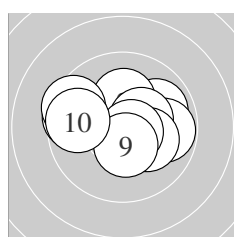
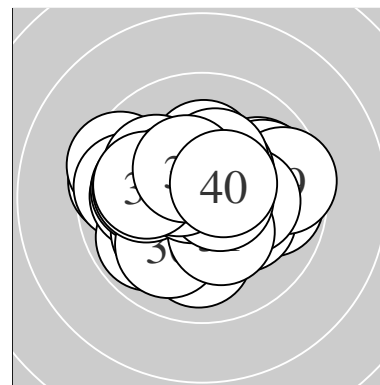

Serie 1:
 9.9 ↗ 10.2 * 9.8 → 10.4 * 9.6 ←
 10.2 * 9.5 ↖ 10.7 * 10.4 * 9.7 ←
 beste Teiler 68.0 (8.) 126.9 (9.) 140.3 (4.)
 Trefferlage 0.08 mm links, 0.34 mm hoch
 Streuwert 1.83, horizontal: 2.39, vertikal: 1.00

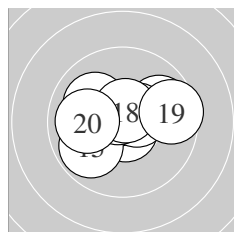

Serie 2:
 10.7 * 10.7 * 9.9 ↗ 10.5 * 9.9 ↗
 10.7 * 10.0 ↖ 10.6 * 9.6 → 10.0 ←
 beste Teiler 57.0 (11.) 68.6 (12.) 74.6 (16.)
 Trefferlage 0.00 mm , 0.34 mm hoch
 Streuwert 1.50, horizontal: 1.94, vertikal: 0.86

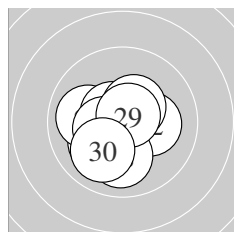

Serie 3:
 10.1 ↙ 10.2 * 10.5 * 10.0 ← 10.6 *
 10.4 * 10.4 * 10.0 ↓ 10.7 * 10.0 ↘
 beste Teiler 61.0 (29.) 93.2 (25.) 123.6 (23.)
 Trefferlage 0.54 mm links, 0.45 mm tief
 Streuwert 1.21, horizontal: 1.28, vertikal: 1.14

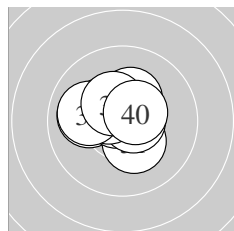

Serie 4:
 10.3 * 10.0 ← 10.7 * 10.3 * 10.6 *
 10.4 * 10.5 * 10.0 ← 10.4 * 10.5 *
 beste Teiler 54.6 (33.) 76.0 (35.) 108.1 (40.)
 Trefferlage 0.49 mm links, 0.46 mm hoch
 Streuwert 1.04, horizontal: 1.24, vertikal: 0.79

Unterschrift des Schützen

Ergebnis: **410.8** (391)
 Serien: 102.4 102.0 102.8 103.6
 Zähler: 31 9 0 0 0 0 0 0 0 0
 Innenzehner: 26
 weiteste: 480 (20), 385 (18), 374 (24)
 beste Teiler 32.5 (34.) 60.4 (27.) 63.6 (14.)
 Trefferlage 0.01 mm rechts, 0.26 mm hoch
 Streuwert 1.43, horizontal: 1.79, vertikal: 0.95

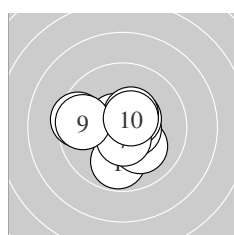
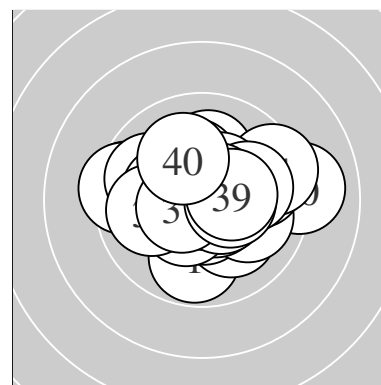

Serie 1:
 9.8 ↓ 10.1 ↘ 10.6 * 10.6 * 10.5 *
 9.5 ← 10.6 * 10.5 * 9.6 ← 10.6 *
 beste Teiler 79.5 (3.) 93.2 (4.) 93.4 (7.)
 Trefferlage 0.31 mm links, 0.14 mm tief
 Streuwert 1.52, horizontal: 1.77, vertikal: 1.24

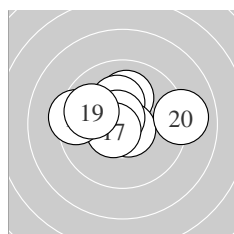

Serie 2:
 10.1 ↑ 10.2 * 10.7 * 10.7 * 10.7 *
 10.7 * 10.6 * 9.4 ← 9.9 ↖ 9.0 →
 beste Teiler 63.6 (14.) 68.2 (16.) 70.0 (13.)
 Trefferlage 0.36 mm links, 0.64 mm hoch
 Streuwert 1.68, horizontal: 2.22, vertikal: 0.84

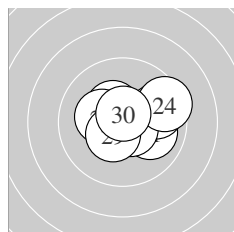

Serie 3:
 10.0 ↗ 9.8 → 10.6 * 9.5 → 10.4 *
 10.4 * 10.7 * 10.3 * 10.4 * 10.7 *
 beste Teiler 60.4 (27.) 69.2 (30.) 87.2 (23.)
 Trefferlage 0.40 mm rechts, 0.27 mm hoch
 Streuwert 1.40, horizontal: 1.80, vertikal: 0.84

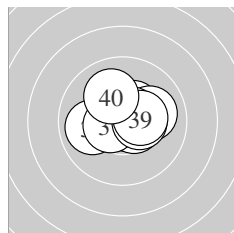

Serie 4:
 10.4 * 9.9 ← 10.0 → 10.8 * 10.6 *
 10.5 * 10.5 * 10.4 * 10.4 * 10.1 ↘
 beste Teiler 32.5 (34.) 90.6 (35.) 101.2 (36.)
 Trefferlage 0.34 mm rechts, 0.29 mm hoch
 Streuwert 1.14, horizontal: 1.41, vertikal: 0.79

Unterschrift des Schützen

Meyton Elektronik

Ergebnis: **406.9** (389)

Serien: 101.2 101.0 102.7 102.0

Zähler: 29 11 0 0 0 0 0 0 0 0

Innenzehner: 22

weiteste: 344 (1), 335 (2), 328 (17)

beste Teiler 87.2 (7.) 89.0 (20.) 94.3 (13.)

Trefferlage 0.24 mm rechts, 0.39 mm hoch

Streuwert 1.46, horizontal: 1.52, vertikal: 1.38

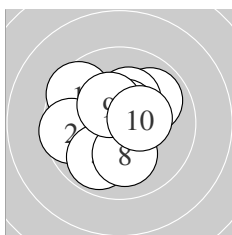
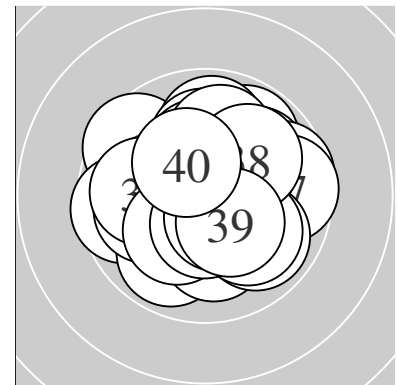

Serie 1:

9.6 ↘	9.6 ←	10.4 *	9.9 ✓	9.9 ↗
10.3 *	10.6 *	10.1 ↓	10.4 *	10.4 *

beste Teiler 87.2 (7.) 127.4 (3.) 141.8 (10.)

Trefferlage 0.36 mm links, 0.38 mm hoch

Streuwert 1.64, horizontal: 1.73, vertikal: 1.55

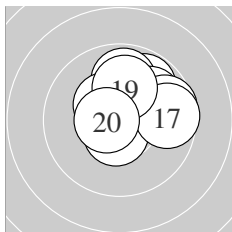

Serie 2:

9.8 ↗	10.4 *	10.6 *	9.9 ↑	9.9 ↗
9.7 →	9.6 →	10.4 *	10.1 ↑	10.6 *

beste Teiler 89.0 (20.) 94.3 (13.) 140.1 (12.)

Trefferlage 0.91 mm rechts, 1.12 mm hoch

Streuwert 1.35, horizontal: 1.53, vertikal: 1.13

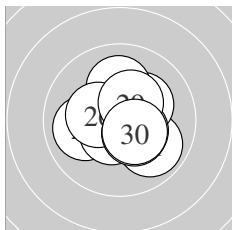

Serie 3:

9.9 ↘	10.0 ←	10.2 *	10.6 *	10.1 ↑
10.3 *	10.4 *	10.4 *	10.4 *	10.4 *

beste Teiler 99.0 (24.) 131.8 (30.) 132.3 (28.)

Trefferlage 0.30 mm rechts, 0.06 mm tief

Streuwert 1.31, horizontal: 1.40, vertikal: 1.21

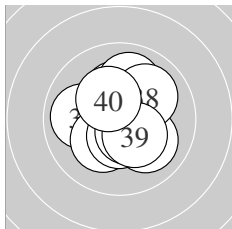

Serie 4:

9.9 ←	10.0 ↘	10.2 *	10.5 *	10.2 *
10.5 *	10.0 ↑	10.0 ↗	10.4 *	10.3 *

beste Teiler 103.7 (36.) 116.0 (34.) 150.6 (39.)

Trefferlage 0.10 mm rechts, 0.12 mm hoch

Streuwert 1.42, horizontal: 1.34, vertikal: 1.50

Unterschrift des Schützen

Meyton Elektronik

Ergebnis: **413.5** (396)
 Serien: 103.6 104.3 102.2 103.4
 Zähler: 36 4 0 0 0 0 0 0 0 0
 Innenzehner: 28
 weiteste: 321 (25), 306 (30), 285 (23)
 beste Teiler 11.1 (20.) 39.8 (4.) 48.0 (21.)
 Trefferlage 0.11 mm rechts, 0.20 mm hoch
 Streuwert 1.22, horizontal: 1.43, vertikal: 0.96

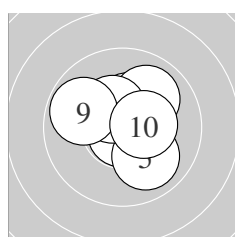
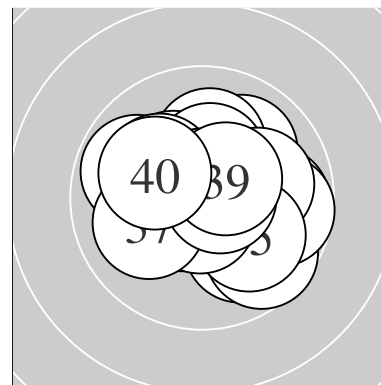

Serie 1:
 10.6 * 10.7 * 10.5 * 10.8 * 10.0 ↘
 10.4 * 10.0 ↗ 10.4 * 9.8 ↖ 10.4 *
 beste Teiler 39.8 (4.) 70.6 (2.) 94.8 (1.)
 Trefferlage 0.26 mm rechts, 0.54 mm hoch
 Streuwert 1.18, horizontal: 1.28, vertikal: 1.07

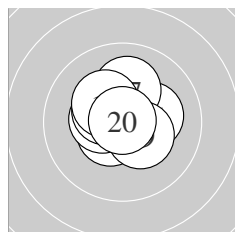

Serie 2:
 10.5 * 10.6 * 10.5 * 10.4 * 10.2 *
 10.4 * 10.1 ↑ 10.3 * 10.4 * 10.9 *
 beste Teiler 11.1 (20.) 90.5 (12.) 105.1 (13.)
 Trefferlage 0.08 mm links, 0.33 mm hoch
 Streuwert 1.02, horizontal: 1.10, vertikal: 0.93

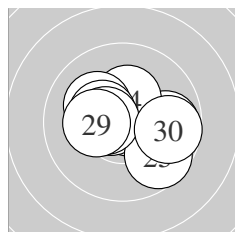

Serie 3:
 10.8 * 10.6 * 9.8 → 10.3 * 9.7 ↘
 10.1 ↖ 10.4 * 10.5 * 10.3 * 9.7 →
 beste Teiler 48.0 (21.) 76.1 (22.) 113.4 (28.)
 Trefferlage 0.24 mm rechts, 0.04 mm hoch
 Streuwert 1.51, horizontal: 1.89, vertikal: 0.99

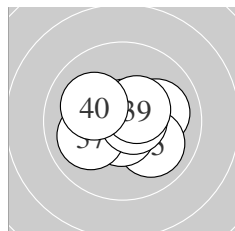

Serie 4:
 10.6 * 10.0 → 10.2 * 10.7 * 10.0 ↘
 10.6 * 10.0 ← 10.7 * 10.5 * 10.1 ↖
 beste Teiler 52.0 (34.) 72.1 (38.) 76.4 (36.)
 Trefferlage 0.03 mm rechts, 0.11 mm tief
 Streuwert 1.23, horizontal: 1.53, vertikal: 0.83

Unterschrift des Schützen

Meyton Elektronik

Ergebnis: **407.5** (391)
 Serien: 101.8 100.6 103.5 101.6
 Zähler: 32 7 1 0 0 0 0 0 0 0
 Innenzehner: 23
 weiteste: 592 (39), 420 (12), 397 (7)
 beste Teiler 16.9 (20.) 17.1 (34.) 31.7 (9.)
 Trefferlage 0.08 mm links, 0.44 mm hoch
 Streuwert 1.58, horizontal: 1.76, vertikal: 1.37

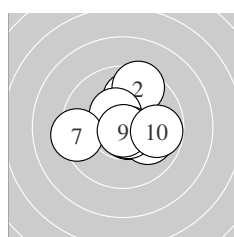
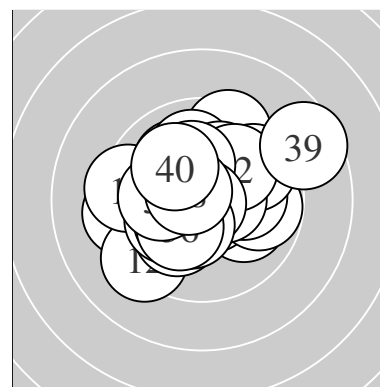

Serie 1:
 9.9 ↑ 9.5 ↑ 10.6 * 10.7 * 10.0 ↘
 10.4 * 9.4 ← 10.7 * 10.8 * 9.8 →
 beste Teiler 31.7 (9.) 66.5 (8.) 69.4 (4.)
 Trefferlage 0.29 mm rechts, 0.45 mm hoch
 Streuwert 1.67, horizontal: 1.85, vertikal: 1.48

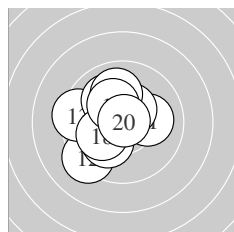

Serie 2:
 10.1 → 9.3 ↙ 9.4 ← 10.4 * 10.0 ↘
 10.0 ↑ 10.1 ↙ 10.1 ↙ 10.3 * 10.9 *
 beste Teiler 16.9 (20.) 129.0 (14.) 170.0 (19.)
 Trefferlage 0.95 mm links, 0.20 mm hoch
 Streuwert 1.70, horizontal: 1.72, vertikal: 1.68

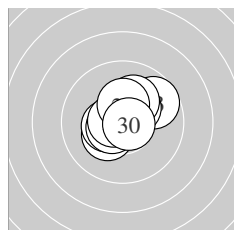

Serie 3:
 10.3 * 10.4 * 9.7 ↗ 10.3 * 10.4 *
 10.6 * 10.6 * 10.2 * 10.3 * 10.7 *
 beste Teiler 55.6 (30.) 76.6 (27.) 100.6 (26.)
 Trefferlage 0.14 mm rechts, 0.54 mm hoch
 Streuwert 1.14, horizontal: 1.24, vertikal: 1.03

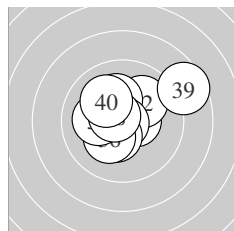

Serie 4:
 10.5 * 10.0 ↗ 10.2 * 10.9 * 10.4 *
 10.2 * 10.1 ← 10.6 * 8.6 ↗ 10.1 ↘
 beste Teiler 17.1 (34.) 83.2 (38.) 108.0 (31.)
 Trefferlage 0.15 mm rechts, 0.57 mm hoch
 Streuwert 1.78, horizontal: 2.10, vertikal: 1.39

Unterschrift des Schützen

Ergebnis: **409.8** (392)
 Serien: 103.5 101.2 103.5 101.6
 Zähler: 32 8 0 0 0 0 0 0 0 0
 Innenzehner: 24
 weiteste: 407 (39), 375 (9), 366 (19)
 beste Teiler 46.3 (30.) 54.5 (1.) 57.4 (6.)
 Trefferlage 0.26 mm rechts, 0.31 mm tief
 Streuwert 1.40, horizontal: 1.48, vertikal: 1.31

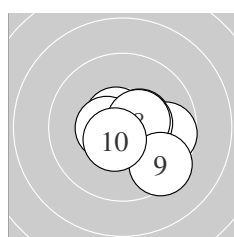
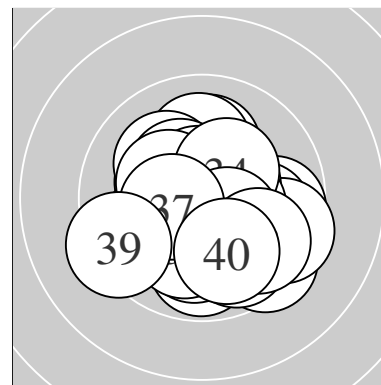

Serie 1:
 10.7 * 10.4 * 10.6 * 9.7 → 10.4 *
 10.7 * 10.5 * 10.5 * 9.5 ↘ 10.5 *
 beste Teiler 54.5 (1.) 57.4 (6.) 76.2 (3.)
 Trefferlage 0.64 mm rechts, 0.22 mm tief
 Streuwert 1.23, horizontal: 1.44, vertikal: 0.97

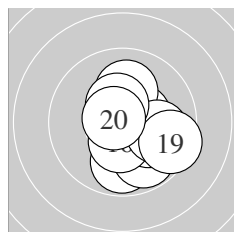

Serie 2:
 9.8 ↓ 9.8 ↘ 10.5 * 10.1 ↑ 10.1 →
 10.4 * 9.9 → 10.4 * 9.5 → 10.7 *
 beste Teiler 68.9 (20.) 125.9 (13.) 129.0 (18.)
 Trefferlage 0.93 mm rechts, 0.55 mm tief
 Streuwert 1.46, horizontal: 1.35, vertikal: 1.57

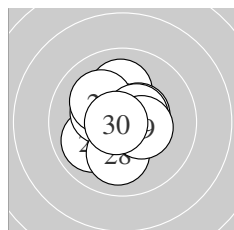

Serie 3:
 10.1 ↑ 10.5 * 10.7 * 10.0 ← 10.3 *
 10.1 ↘ 10.5 * 10.1 ↓ 10.4 * 10.8 *
 beste Teiler 46.3 (30.) 68.1 (23.) 109.5 (27.)
 Trefferlage 0.25 mm links, 0.07 mm hoch
 Streuwert 1.25, horizontal: 1.19, vertikal: 1.30

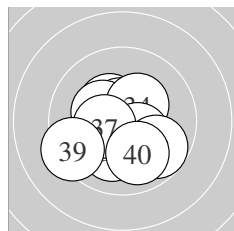

Serie 4:
 10.4 * 10.6 * 10.3 * 10.3 * 10.4 *
 10.1 ↓ 10.4 * 9.8 ↘ 9.3 ← 10.0 ↓
 beste Teiler 83.7 (32.) 134.4 (37.) 142.4 (35.)
 Trefferlage 0.25 mm links, 0.57 mm tief
 Streuwert 1.57, horizontal: 1.70, vertikal: 1.42

Unterschrift des Schützen

Meyton Elektronik

Ergebnis: **407.2** (389)
 Serien: 101.1 101.5 102.2 102.4
 Zähler: 29 11 0 0 0 0 0 0 0 0
 Innenzehner: 26
 weiteste: 433 (28), 425 (31), 398 (5)
 beste Teiler 3.1 (32.) 43.5 (29.) 59.9 (23.)
 Trefferlage 0.01 mm links, 0.09 mm tief
 Streuwert 1.57, horizontal: 1.77, vertikal: 1.33

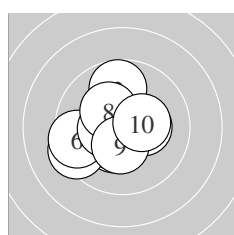
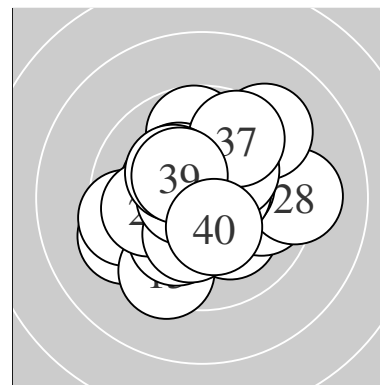

Serie 1:
 10.3 * 9.7 ↑ 10.4 * 10.4 * 9.4 ↙
 9.5 ← 10.4 * 10.3 * 10.4 * 10.3 *
 beste Teiler 127.9 (4.) 128.5 (7.) 140.1 (9.)
 Trefferlage 0.82 mm links, 0.20 mm tief
 Streuwert 1.61, horizontal: 1.74, vertikal: 1.46

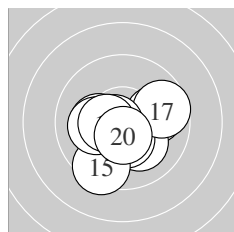

Serie 2:
 9.9 → 10.1 ↘ 10.4 * 10.2 * 9.4 ↙
 10.1 ← 9.7 → 10.7 * 10.5 * 10.5 *
 beste Teiler 65.9 (18.) 103.0 (20.) 123.2 (19.)
 Trefferlage 0.03 mm links, 0.62 mm tief
 Streuwert 1.56, horizontal: 1.81, vertikal: 1.26

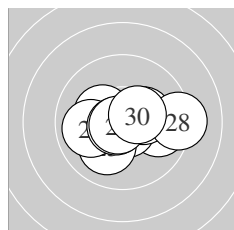

Serie 3:
 10.3 * 9.8 → 10.7 * 10.3 * 10.1 ↙
 9.9 ← 10.7 * 9.2 → 10.8 * 10.4 *
 beste Teiler 43.5 (29.) 59.9 (23.) 61.4 (27.)
 Trefferlage 0.40 mm rechts, 0.20 mm tief
 Streuwert 1.57, horizontal: 2.09, vertikal: 0.73

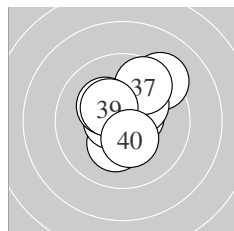

Serie 4:
 9.3 ↗ 10.9 * 10.2 * 10.5 * 10.2 *
 10.6 * 9.7 ↗ 10.2 * 10.4 * 10.4 *
 beste Teiler 3.1 (32.) 83.1 (36.) 104.0 (34.)
 Trefferlage 0.37 mm rechts, 0.66 mm hoch
 Streuwert 1.46, horizontal: 1.37, vertikal: 1.55

Unterschrift des Schützen

Ergebnis: **410.6** (393)
 Serien: 102.4 101.7 102.9 103.6
 Zähler: 33 7 0 0 0 0 0 0 0 0
 Innenzehner: 27
 weiteste: 475 (28), 354 (1), 284 (27)
 beste Teiler 29.8 (31.) 35.4 (22.) 59.3 (4.)
 Trefferlage 0.06 mm rechts, 0.05 mm tief
 Streuwert 1.38, horizontal: 1.27, vertikal: 1.47

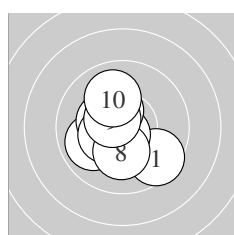
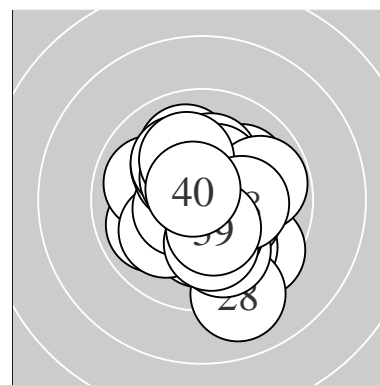

Serie 1:
 9.5 ↘ 10.4 * 9.9 ↙ 10.7 * 10.4 *
 10.4 * 10.4 * 10.2 * 10.5 * 10.0 ↗
 beste Teiler 59.3 (4.) 103.8 (9.) 141.3 (7.)
 Trefferlage 0.58 mm links, 0.09 mm tief
 Streuwert 1.39, horizontal: 1.30, vertikal: 1.47

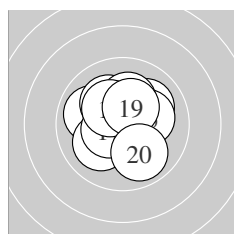

Serie 2:
 9.9 ↖ 10.2 * 10.0 ↗ 10.1 ↘ 10.2 *
 10.2 * 10.5 * 10.3 * 10.4 * 9.9 ↘
 beste Teiler 112.1 (17.) 149.4 (19.) 158.8 (18.)
 Trefferlage 0.11 mm links, 0.46 mm hoch
 Streuwert 1.46, horizontal: 1.53, vertikal: 1.38

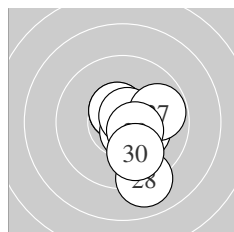

Serie 3:
 10.6 * 10.8 * 10.6 * 10.6 * 10.3 *
 10.7 * 9.8 → 9.1 ↓ 10.5 * 9.9 ↘
 beste Teiler 35.4 (22.) 60.6 (26.) 86.0 (24.)
 Trefferlage 0.82 mm rechts, 0.57 mm tief
 Streuwert 1.39, horizontal: 0.99, vertikal: 1.70

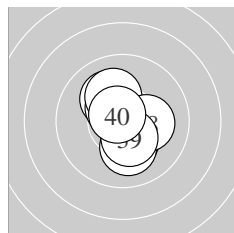

Serie 4:
 10.8 * 10.3 * 10.1 ↓ 10.1 ↖ 10.4 *
 10.5 * 10.1 ↖ 10.2 * 10.4 * 10.7 *
 beste Teiler 29.8 (31.) 66.7 (40.) 107.7 (36.)
 Trefferlage 0.14 mm rechts, 0.00 mm
 Streuwert 1.16, horizontal: 0.93, vertikal: 1.36

Unterschrift des Schützen

Ergebnis: **414.3** (395)^{QF}
 Serien: 103.2 104.5 102.2 104.4
 Zähler: 35 5 0 0 0 0 0 0 0 0
 Innenzehner: 32
 weiteste: 344 (8), 330 (2), 289 (15)
 beste Teiler 31.7 (1.) 51.7 (14.) 55.1 (17.)
 Trefferlage 0.06 mm links, 0.01 mm hoch
 Streuwert 1.20, horizontal: 1.39, vertikal: 0.98

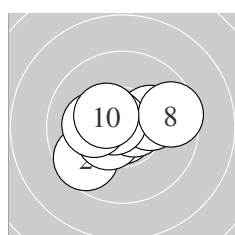
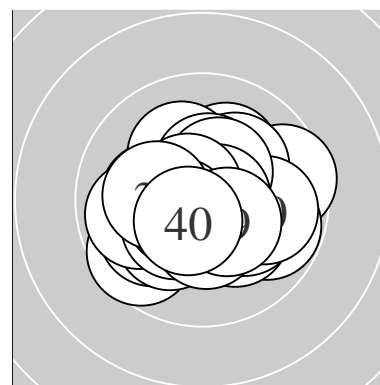

Serie 1:
 10.8 * 9.6 ↙ 10.5 * 10.6 * 10.6 *
 10.2 * 10.7 * 9.6 → 10.2 * 10.4 *
 beste Teiler 31.7 (1.) 68.4 (7.) 80.2 (5.)
 Trefferlage 0.20 mm links, 0.03 mm hoch
 Streuwert 1.41, horizontal: 1.77, vertikal: 0.90

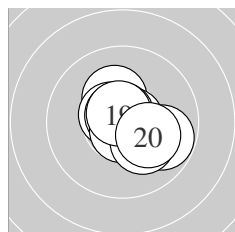

Serie 2:
 10.2 * 10.7 * 10.6 * 10.7 * 9.8 →
 10.7 * 10.7 * 10.2 * 10.7 * 10.2 *
 beste Teiler 51.7 (14.) 55.1 (17.) 59.4 (12.)
 Trefferlage 0.42 mm rechts, 0.00 mm
 Streuwert 1.05, horizontal: 1.15, vertikal: 0.94

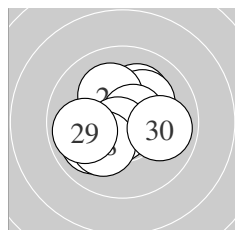

Serie 3:
 10.1 ↗ 10.5 * 10.2 * 10.1 ↖ 10.0 ↙
 10.6 * 10.7 * 10.2 * 9.9 ← 9.9 →
 beste Teiler 60.7 (27.) 81.3 (26.) 115.6 (22.)
 Trefferlage 0.24 mm links, 0.15 mm hoch
 Streuwert 1.44, horizontal: 1.63, vertikal: 1.22

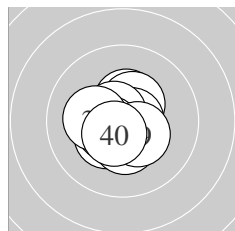

Serie 4:
 10.4 * 10.3 * 10.4 * 10.7 * 10.6 *
 10.5 * 10.2 * 10.4 * 10.4 * 10.5 *
 beste Teiler 60.2 (34.) 77.3 (35.) 104.5 (40.)
 Trefferlage 0.23 mm links, 0.15 mm tief
 Streuwert 0.94, horizontal: 0.93, vertikal: 0.96

QF – Schütze hat sich fürs Finale qualifiziert

Unterschrift des Schützen

Meyton Elektronik

Ergebnis: **414.4** (394)^{QF}
 Serien: 102.4 103.6 102.8 105.6
 Zähler: 34 6 0 0 0 0 0 0 0 0
 Innenzehner: 32
 weiteste: 367 (21), 352 (20), 349 (7)
 beste Teiler 9.4 (13.) 24.0 (11.) 33.0 (36.)
 Trefferlage 0.17 mm links, 0.24 mm tief
 Streuwert 1.24, horizontal: 0.94, vertikal: 1.47

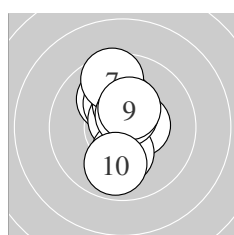
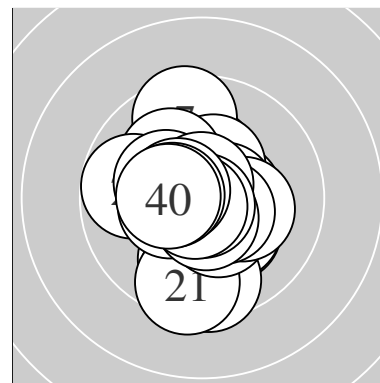

Serie 1:
 10.0 ↖ 10.2 * 10.7 * 10.5 * 10.3 *
 10.2 * 9.6 ↗ 10.6 * 10.4 * 9.9 ↓
 beste Teiler 58.1 (3.) 92.3 (8.) 118.8 (4.)
 Trefferlage 0.11 mm links, 0.72 mm hoch
 Streuwert 1.35, horizontal: 0.66, vertikal: 1.80

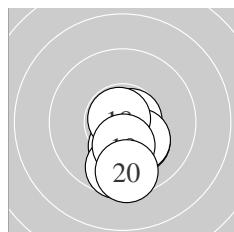

Serie 2:
 10.9 * 10.2 * 10.9 * 10.3 * 10.7 *
 10.3 * 9.7 ↓ 10.8 * 10.3 * 9.5 ↓
 beste Teiler 9.4 (13.) 24.0 (11.) 34.6 (18.)
 Trefferlage 0.27 mm rechts, 1.24 mm tief
 Streuwert 1.04, horizontal: 0.55, vertikal: 1.36

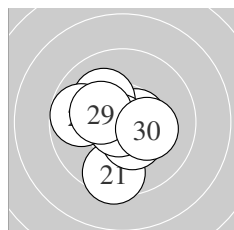

Serie 3:
 9.5 ↓ 10.7 * 10.6 * 10.4 * 10.4 *
 10.1 ↖ 9.8 ← 10.8 * 10.3 * 10.2 *
 beste Teiler 36.1 (28.) 63.7 (22.) 93.0 (23.)
 Trefferlage 0.29 mm links, 0.32 mm tief
 Streuwert 1.41, horizontal: 1.43, vertikal: 1.40

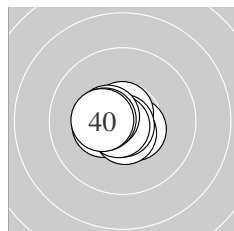

Serie 4:
 10.5 * 10.5 * 10.7 * 10.4 * 10.6 *
 10.8 * 10.8 * 10.5 * 10.4 * 10.4 *
 beste Teiler 33.0 (36.) 47.6 (37.) 58.1 (33.)
 Trefferlage 0.55 mm links, 0.12 mm tief
 Streuwert 0.65, horizontal: 0.80, vertikal: 0.45

QF – Schütze hat sich fürs Finale qualifiziert

Unterschrift des Schützen

Meyton Elektronik

Ergebnis: **411.0** (393)
 Serien: 102.9 102.1 102.9 103.1
 Zähler: 33 7 0 0 0 0 0 0 0 0
 Innenzehner: 27
 weiteste: 320 (9), 277 (15), 270 (21)
 beste Teiler 9.0 (34.) 43.4 (6.) 59.4 (36.)
 Trefferlage 0.27 mm rechts, 0.39 mm hoch
 Streuwert 1.28, horizontal: 1.29, vertikal: 1.26

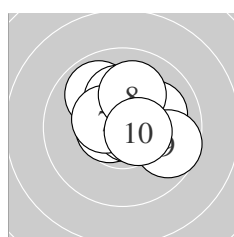
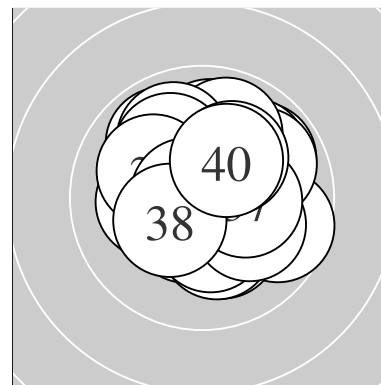

Serie 1:
 9.9 ↖ 10.5 * 10.6 * 10.2 * 10.1 ↗
 10.8 * 10.5 * 10.1 ↑ 9.7 ↘ 10.5 *
 beste Teiler 43.4 (6.) 86.5 (3.) 107.0 (10.)
 Trefferlage 0.40 mm rechts, 0.69 mm hoch
 Streuwert 1.28, horizontal: 1.43, vertikal: 1.11

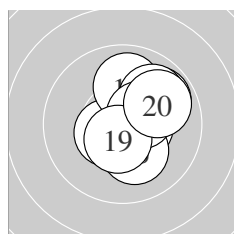

Serie 2:
 10.5 * 10.5 * 10.4 * 10.0 ↑ 9.8 ↗
 10.2 * 9.9 ↗ 10.4 * 10.5 * 9.9 ↗
 beste Teiler 104.6 (19.) 112.1 (11.) 112.5 (12.)
 Trefferlage 0.90 mm rechts, 0.29 mm hoch
 Streuwert 1.28, horizontal: 1.09, vertikal: 1.45

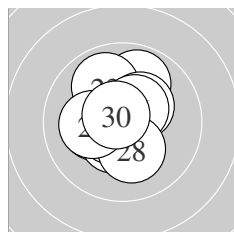

Serie 3:
 9.9 ↑ 10.2 * 9.9 ↖ 10.3 * 10.4 *
 10.5 * 10.6 * 10.2 * 10.2 * 10.7 *
 beste Teiler 64.3 (30.) 89.8 (27.) 120.3 (26.)
 Trefferlage 0.31 mm links, 0.33 mm hoch
 Streuwert 1.28, horizontal: 1.14, vertikal: 1.41

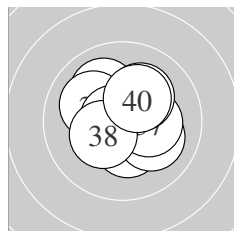

Serie 4:
 10.0 ↖ 10.1 ↖ 10.3 * 10.9 * 10.1 ↗
 10.7 * 10.3 * 10.3 * 10.2 * 10.2 *
 beste Teiler 9.0 (34.) 59.4 (36.) 153.8 (33.)
 Trefferlage 0.09 mm rechts, 0.26 mm hoch
 Streuwert 1.28, horizontal: 1.34, vertikal: 1.21

Unterschrift des Schützen

Ergebnis:	414.0	(396) ^{QF}
Serien:	103.6	104.3 103.1 103.0
Zähler:	36	4 0 0 0 0 0 0 0 0
Innenzehner:	31	
weiteste:	329	(32), 279 (36), 261 (21)
beste Teiler	43.6	(31.) 54.6 (23.) 64.8 (17.)
Trefferlage	0.21 mm links, 0.32 mm tief	
Streuwert	1.14, horizontal: 1.26, vertikal: 1.00	

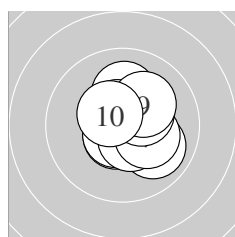
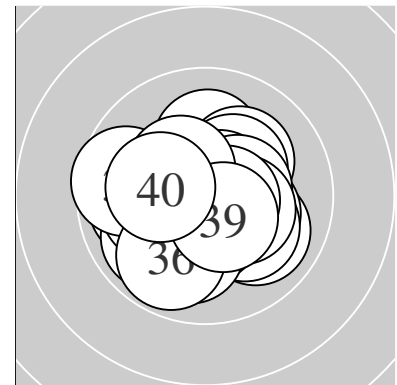

Serie 1:	10.0 ↘	10.6 *	10.1 ↑	10.6 *	10.6 *
	10.5 *	10.2 *	10.3 *	10.2 *	10.5 *
beste Teiler	80.0 (5.) 87.4 (2.) 93.6 (4.)				
Trefferlage	0.49 mm rechts, 0.15 mm hoch				
Streuwert	1.12, horizontal: 1.05, vertikal: 1.18				

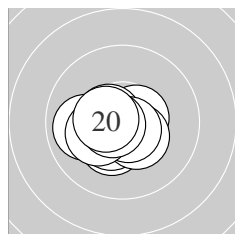

Serie 2:	10.3 *	10.6 *	10.6 *	9.9 ←	10.4 *
	10.4 *	10.7 *	10.2 *	10.7 *	10.5 *
beste Teiler	64.8 (17.) 70.3 (19.) 96.1 (12.)				
Trefferlage	0.62 mm links, 0.43 mm tief				
Streuwert	0.89, horizontal: 1.11, vertikal: 0.60				

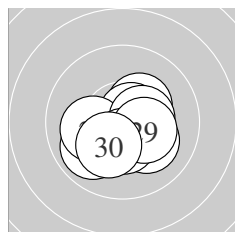

Serie 3:	9.9 ↙	10.3 *	10.7 *	10.7 *	10.1 ←
	10.4 *	10.1 ↘	10.4 *	10.3 *	10.2 *
beste Teiler	54.6 (23.) 73.4 (24.) 130.3 (28.)				
Trefferlage	0.10 mm rechts, 0.55 mm tief				
Streuwert	1.18, horizontal: 1.38, vertikal: 0.92				

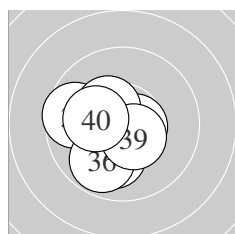

Serie 4:	10.8 *	9.6 ←	10.4 *	10.1 ↓	10.6 *
	9.8 ↙	10.6 *	10.4 *	10.5 *	10.2 *
beste Teiler	43.6 (31.) 83.5 (35.) 83.9 (37.)				
Trefferlage	0.84 mm links, 0.48 mm tief				
Streuwert	1.18, horizontal: 1.18, vertikal: 1.17				

QF – Schütze hat sich fürs Finale qualifiziert

Unterschrift des Schützen

Meyton Elektronik

Ergebnis: **412.3** (395)
 Serien: 102.6 104.7 103.4 101.6
 Zähler: 35 5 0 0 0 0 0 0 0 0
 Innenzehner: 33
 weiteste: 437 (39), 379 (23), 337 (36)
 beste Teiler 15.6 (35.) 45.9 (13.) 64.0 (6.)
 Trefferlage 0.18 mm links, 0.25 mm hoch
 Streuwert 1.30, horizontal: 1.40, vertikal: 1.19

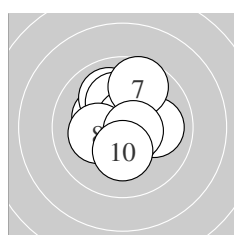
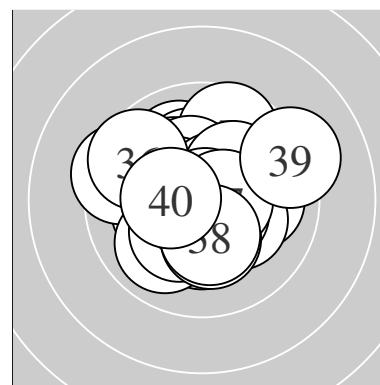

Serie 1:
 10.0 → 10.6 * 10.3 * 10.0 ↗ 10.2 *
 10.7 * 9.7 ↑ 10.2 * 10.6 * 10.3 *
 beste Teiler 64.0 (6.) 79.6 (2.) 83.4 (9.)
 Trefferlage 0.01 mm rechts, 0.52 mm hoch
 Streuwert 1.37, horizontal: 1.28, vertikal: 1.46

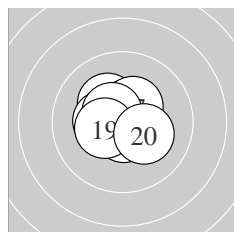

Serie 2:
 10.2 * 10.6 * 10.8 * 10.4 * 10.6 *
 10.6 * 10.4 * 10.5 * 10.4 * 10.2 *
 beste Teiler 45.9 (13.) 76.5 (15.) 87.2 (12.)
 Trefferlage 0.09 mm links, 0.14 mm hoch
 Streuwert 0.94, horizontal: 1.03, vertikal: 0.83

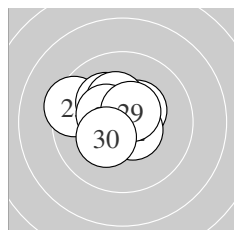

Serie 3:
 10.4 * 10.6 * 9.4 ↖ 10.2 * 10.6 *
 10.3 * 10.6 * 10.4 * 10.6 * 10.3 *
 beste Teiler 79.9 (25.) 95.6 (22.) 98.4 (29.)
 Trefferlage 0.69 mm links, 0.48 mm hoch
 Streuwert 1.14, horizontal: 1.35, vertikal: 0.89

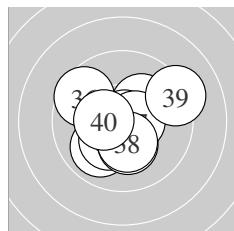

Serie 4:
 9.9 ↙ 10.2 * 10.3 * 10.2 * 10.9 *
 9.6 ↘ 10.6 * 10.3 * 9.2 → 10.4 *
 beste Teiler 15.6 (35.) 93.0 (37.) 140.2 (40.)
 Trefferlage 0.02 mm rechts, 0.15 mm tief
 Streuwert 1.70, horizontal: 1.90, vertikal: 1.47

Unterschrift des Schützen

Meyton Elektronik

Ergebnis: **412.8** (395)
 Serien: 103.6 102.5 102.7 104.0
 Zähler: 35 5 0 0 0 0 0 0 0 0
 Innenzehner: 30
 weiteste: 378 (9), 363 (19), 322 (28)
 beste Teiler 32.0 (39.) 38.0 (25.) 42.9 (33.)
 Trefferlage 0.20 mm links, 0.51 mm tief
 Streuwert 1.22, horizontal: 1.34, vertikal: 1.08

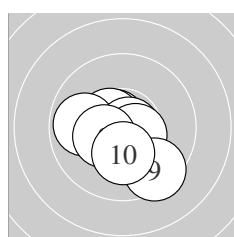
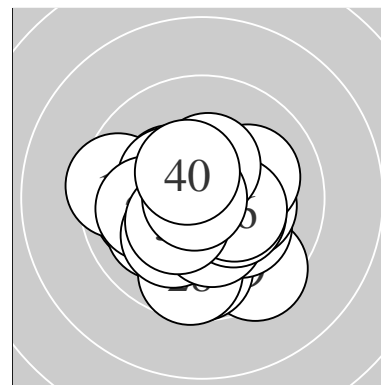

Serie 1:
 10.7 * 10.5 * 10.6 * 9.9 ← 10.6 *
 10.8 * 10.5 * 10.4 * 9.4 ↘ 10.2 *
 beste Teiler 44.1 (6.) 72.6 (1.) 77.8 (5.)
 Trefferlage 0.15 mm links, 0.65 mm tief
 Streuwert 1.23, horizontal: 1.35, vertikal: 1.09

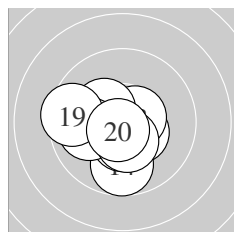

Serie 2:
 10.5 * 10.4 * 10.6 * 9.7 ↓ 10.4 *
 10.3 * 10.0 ← 10.4 * 9.5 ← 10.7 *
 beste Teiler 65.8 (20.) 94.3 (13.) 110.1 (11.)
 Trefferlage 0.64 mm links, 0.52 mm tief
 Streuwert 1.32, horizontal: 1.47, vertikal: 1.16

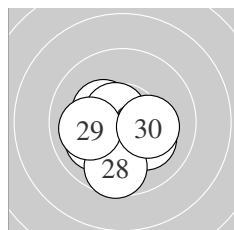

Serie 3:
 10.3 * 10.6 * 10.2 * 10.2 * 10.8 *
 10.6 * 10.1 ↙ 9.7 ↓ 10.0 ← 10.2 *
 beste Teiler 38.0 (25.) 77.1 (26.) 92.6 (22.)
 Trefferlage 0.21 mm links, 0.69 mm tief
 Streuwert 1.31, horizontal: 1.48, vertikal: 1.10

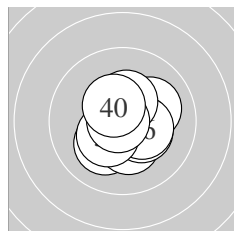

Serie 4:
 10.1 ↙ 10.1 ↗ 10.8 * 10.3 * 10.3 *
 10.4 * 10.4 * 10.4 * 10.8 * 10.4 *
 beste Teiler 32.0 (39.) 42.9 (33.) 126.7 (40.)
 Trefferlage 0.17 mm rechts, 0.18 mm tief
 Streuwert 1.09, horizontal: 1.10, vertikal: 1.08

Unterschrift des Schützen

Meyton Elektronik

Ergebnis: **417.1** (398)^{QF}
 Serien: 104.0 104.2 105.1 103.8
 Zähler: 38 2 0 0 0 0 0 0 0 0
 Innenzehner: 35
 weiteste: 435 (2), 320 (17), 237 (13)
 beste Teiler 1.4 (19.) 29.1 (1.) 30.0 (22.)
 Trefferlage 0.37 mm links, 0.38 mm hoch
 Streuwert 1.03, horizontal: 1.20, vertikal: 0.84

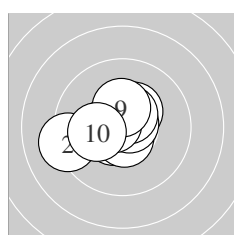
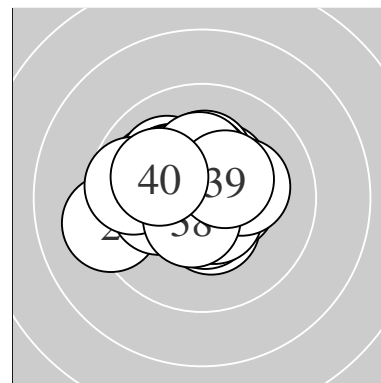

Serie 1:
 10.8 * 9.2 ← 10.6 * 10.4 * 10.6 *
 10.7 * 10.5 * 10.6 * 10.4 * 10.2 *
 beste Teiler 29.1 (1.) 58.5 (6.) 81.5 (8.)
 Trefferlage 0.59 mm links, 0.14 mm hoch
 Streuwert 1.24, horizontal: 1.50, vertikal: 0.90

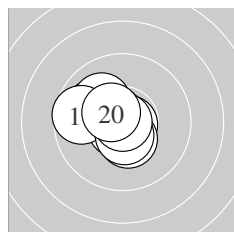

Serie 2:
 10.7 * 10.6 * 10.0 ↖ 10.1 ↖ 10.8 *
 10.4 * 9.7 ← 10.5 * 10.9 * 10.5 *
 beste Teiler 1.4 (19.) 48.3 (15.) 62.2 (11.)
 Trefferlage 0.77 mm links, 0.14 mm hoch
 Streuwert 1.06, horizontal: 1.19, vertikal: 0.90

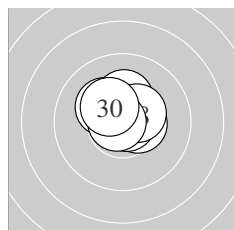

Serie 3:
 10.5 * 10.8 * 10.2 * 10.7 * 10.6 *
 10.6 * 10.2 * 10.4 * 10.8 * 10.3 *
 beste Teiler 30.0 (22.) 44.0 (29.) 71.0 (24.)
 Trefferlage 0.04 mm links, 0.68 mm hoch
 Streuwert 0.74, horizontal: 0.85, vertikal: 0.60

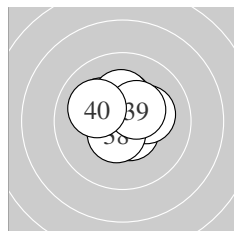

Serie 4:
 10.6 * 10.6 * 10.2 * 10.2 * 10.3 *
 10.6 * 10.3 * 10.5 * 10.4 * 10.1 ↖
 beste Teiler 83.6 (32.) 96.2 (31.) 99.2 (36.)
 Trefferlage 0.07 mm links, 0.58 mm hoch
 Streuwert 1.04, horizontal: 1.18, vertikal: 0.88

QF – Schütze hat sich fürs Finale qualifiziert

Unterschrift des Schützen

Meyton Elektronik

Ergebnis: **413.8** (397)^{QF}
 Serien: 101.8 103.4 105.0 103.6
 Zähler: 37 3 0 0 0 0 0 0 0 0
 Innenzehner: 34
 weiteste: 295 (37), 270 (3), 257 (8)
 beste Teiler 67.2 (33.) 77.9 (20.) 81.2 (32.)
 Trefferlage 0.15 mm rechts, 0.18 mm hoch
 Streuwert 1.14, horizontal: 1.23, vertikal: 1.05

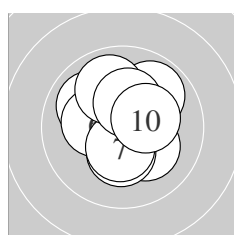
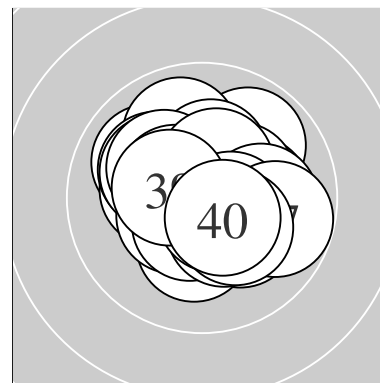

Serie 1:
 10.2 * 10.0 ↘ 9.9 ↗ 10.3 * 10.3 *
 10.2 * 10.4 * 9.9 ↖ 10.3 * 10.3 *
 beste Teiler 128.8 (7.) 153.3 (5.) 159.8 (10.)
 Trefferlage 0.01 mm links, 0.57 mm hoch
 Streuwert 1.40, horizontal: 1.32, vertikal: 1.48

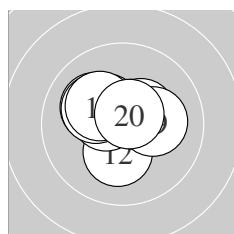

Serie 2:
 10.4 * 10.2 * 10.5 * 10.1 ↘ 10.6 *
 10.4 * 10.2 * 10.2 * 10.2 * 10.6 *
 beste Teiler 77.9 (20.) 91.9 (15.) 118.5 (13.)
 Trefferlage 0.31 mm links, 0.51 mm hoch
 Streuwert 1.11, horizontal: 1.32, vertikal: 0.86

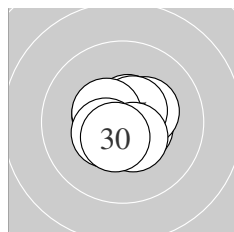

Serie 3:
 10.6 * 10.5 * 10.3 * 10.5 * 10.6 *
 10.6 * 10.5 * 10.4 * 10.5 * 10.5 *
 beste Teiler 81.5 (26.) 89.3 (21.) 98.4 (25.)
 Trefferlage 0.01 mm rechts, 0.04 mm tief
 Streuwert 0.85, horizontal: 0.93, vertikal: 0.77

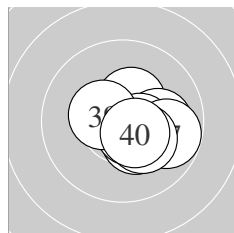

Serie 4:
 10.4 * 10.6 * 10.7 * 10.4 * 10.0 →
 10.5 * 9.8 → 10.3 * 10.4 * 10.5 *
 beste Teiler 67.2 (33.) 81.2 (32.) 111.0 (40.)
 Trefferlage 0.94 mm rechts, 0.30 mm tief
 Streuwert 0.96, horizontal: 1.11, vertikal: 0.79

QF – Schütze hat sich fürs Finale qualifiziert

Unterschrift des Schützen

Meyton Elektronik

Ergebnis: **408.4** (395)
 Serien: 101.8 102.1 102.7 101.8
 Zähler: 35 5 0 0 0 0 0 0 0 0
 Innenzehner: 23
 weiteste: 318 (10), 277 (31), 274 (3)
 beste Teiler 61.9 (16.) 62.6 (25.) 86.7 (37.)
 Trefferlage 0.13 mm rechts, 0.01 mm hoch
 Streuwert 1.40, horizontal: 1.48, vertikal: 1.31

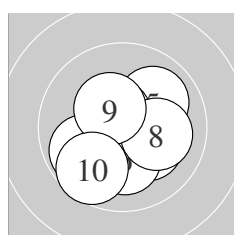
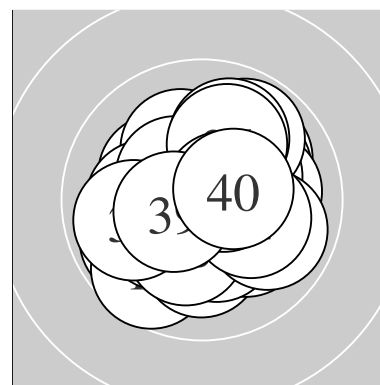

Serie 1:
 10.2 * 10.3 * 9.9 ↙ 10.4 * 10.0 ↗
 10.2 * 10.6 * 10.1 → 10.4 * 9.7 ↙
 beste Teiler 88.8 (7.) 138.3 (4.) 139.5 (9.)
 Trefferlage 0.12 mm rechts, 0.43 mm tief
 Streuwert 1.51, horizontal: 1.57, vertikal: 1.45

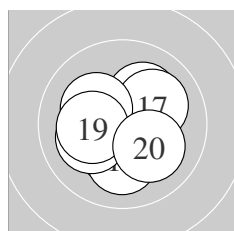

Serie 2:
 10.2 * 10.3 * 10.1 ↓ 10.1 ↙ 10.1 ↗
 10.7 * 10.1 ↗ 10.2 * 10.2 * 10.1 ↘
 beste Teiler 61.9 (16.) 156.3 (12.) 183.0 (11.)
 Trefferlage 0.24 mm links, 0.10 mm tief
 Streuwert 1.40, horizontal: 1.50, vertikal: 1.29

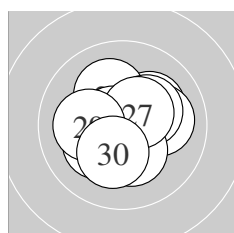

Serie 3:
 10.2 * 10.1 ↖ 10.1 → 10.3 * 10.7 *
 10.3 * 10.5 * 10.2 * 10.1 ← 10.2 *
 beste Teiler 62.6 (25.) 122.2 (27.) 165.4 (26.)
 Trefferlage 0.13 mm rechts, 0.07 mm hoch
 Streuwert 1.33, horizontal: 1.45, vertikal: 1.19

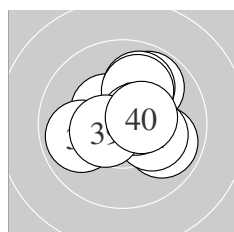

Serie 4:
 9.8 ↗ 10.4 * 9.9 ↘ 10.2 * 10.0 ↗
 10.0 ↗ 10.6 * 9.9 ↙ 10.5 * 10.5 *
 beste Teiler 86.7 (37.) 114.7 (39.) 123.9 (40.)
 Trefferlage 0.51 mm rechts, 0.52 mm hoch
 Streuwert 1.44, horizontal: 1.55, vertikal: 1.31

Unterschrift des Schützen

Ergebnis: **409.5** (391)
 Serien: 104.1 100.6 102.7 102.1
 Zähler: 31 9 0 0 0 0 0 0 0 0
 Innenzehner: 27
 weiteste: 401 (37), 335 (20), 316 (16)
 beste Teiler 55.4 (9.) 57.3 (10.) 74.3 (36.)
 Trefferlage 0.43 mm rechts, 0.29 mm hoch
 Streuwert 1.35, horizontal: 1.28, vertikal: 1.42

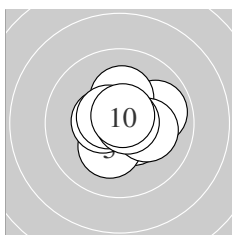
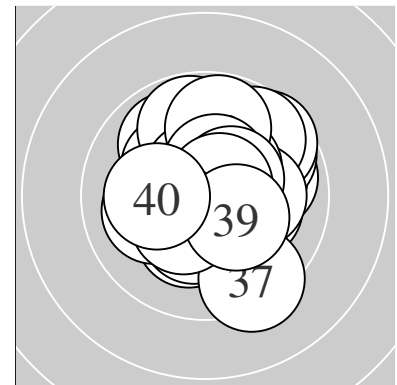

Serie 1:
 9.9 → 10.5 * 10.2 * 10.6 * 10.2 *
 10.5 * 10.2 * 10.6 * 10.7 * 10.7 *
 beste Teiler 55.4 (9.) 57.3 (10.) 91.2 (4.)
 Trefferlage 0.27 mm rechts, 0.08 mm hoch
 Streuwert 1.09, horizontal: 1.24, vertikal: 0.92

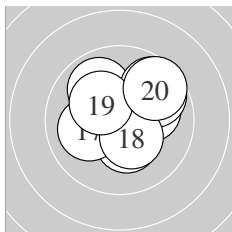

Serie 2:
 9.9 ↘ 10.3 * 10.1 → 10.6 * 9.7 ↗
 9.7 ↗ 10.1 ← 10.4 * 10.2 * 9.6 ↗
 beste Teiler 86.6 (14.) 145.0 (18.) 156.5 (12.)
 Trefferlage 0.62 mm rechts, 0.77 mm hoch
 Streuwert 1.59, horizontal: 1.74, vertikal: 1.42

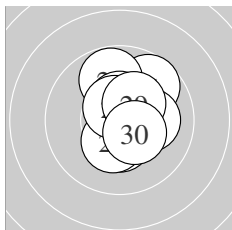

Serie 3:
 9.7 ↗ 10.6 * 9.8 ↑ 10.1 → 10.5 *
 10.4 * 10.3 * 10.6 * 10.3 * 10.4 *
 beste Teiler 93.6 (22.) 96.5 (28.) 120.0 (25.)
 Trefferlage 0.49 mm rechts, 0.56 mm hoch
 Streuwert 1.26, horizontal: 0.99, vertikal: 1.49

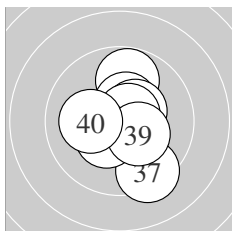

Serie 4:
 10.5 * 10.2 * 9.8 ↑ 10.4 * 10.4 *
 10.7 * 9.3 ↘ 10.4 * 10.3 * 10.1 ←
 beste Teiler 74.3 (36.) 116.0 (31.) 128.7 (34.)
 Trefferlage 0.33 mm rechts, 0.25 mm tief
 Streuwert 1.49, horizontal: 1.23, vertikal: 1.72

Unterschrift des Schützen

Ergebnis: **413.3** (397)
 Serien: 103.5 101.7 103.9 104.2
 Zähler: 37 3 0 0 0 0 0 0 0 0
 Innenzehner: 27
 weiteste: 322 (17), 274 (13), 258 (18)
 beste Teiler 17.7 (26.) 41.0 (38.) 41.6 (1.)
 Trefferlage 0.05 mm rechts, 0.37 mm hoch
 Streuwert 1.21, horizontal: 1.27, vertikal: 1.14

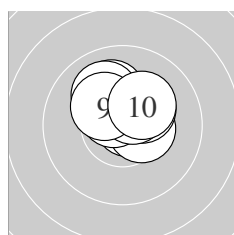
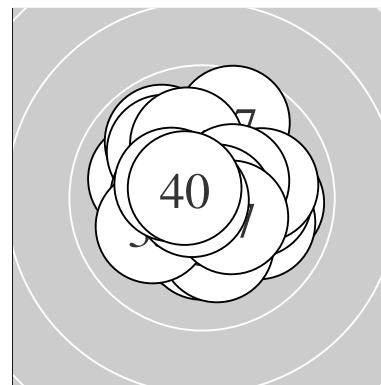

Serie 1:
 10.8 * 10.4 * 10.1 ↗ 10.3 * 10.3 *
 10.6 * 10.5 * 10.0 ↘ 10.3 * 10.2 *
 beste Teiler 41.6 (1.) 97.0 (6.) 119.5 (7.)
 Trefferlage 0.01 mm rechts, 1.06 mm hoch
 Streuwert 0.90, horizontal: 1.06, vertikal: 0.71

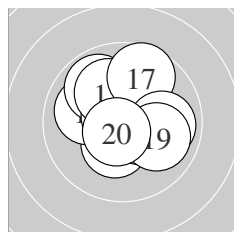

Serie 2:
 10.3 * 10.0 ↖ 9.9 ↘ 10.7 * 10.1 ↗
 10.4 * 9.7 ↗ 9.9 → 10.0 ↘ 10.7 *
 beste Teiler 61.4 (14.) 75.4 (20.) 138.7 (16.)
 Trefferlage 0.11 mm rechts, 0.44 mm hoch
 Streuwert 1.56, horizontal: 1.63, vertikal: 1.49

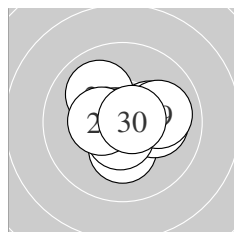

Serie 3:
 10.2 * 10.0 ↘ 10.8 * 10.2 * 10.1 →
 10.9 * 10.6 * 10.4 * 10.0 → 10.7 *
 beste Teiler 17.7 (26.) 48.0 (23.) 64.2 (30.)
 Trefferlage 0.31 mm rechts, 0.02 mm hoch
 Streuwert 1.17, horizontal: 1.37, vertikal: 0.93

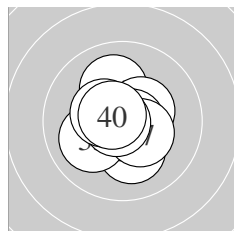

Serie 4:
 10.6 * 10.2 * 10.0 ↖ 10.1 ↗ 10.4 *
 10.7 * 10.4 * 10.8 * 10.4 * 10.6 *
 beste Teiler 41.0 (38.) 57.4 (36.) 79.2 (40.)
 Trefferlage 0.23 mm links, 0.03 mm tief
 Streuwert 1.08, horizontal: 1.06, vertikal: 1.10

Unterschrift des Schützen

Meyton Elektronik

Ergebnis: **395.8** (377)
 Serien: 97.3 100.6 96.8 101.1
 Zähler: 20 17 3 0 0 0 0 0 0 0
 Innenzehner: 14
 weiteste: 619 (23), 540 (8), 529 (25)
 beste Teiler 51.6 (37.) 79.4 (9.) 88.2 (22.)
 Trefferlage 0.14 mm links, 0.32 mm tief
 Streuwert 2.11, horizontal: 2.13, vertikal: 2.09

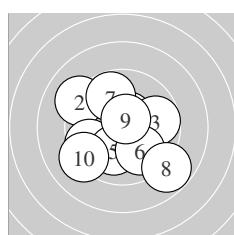
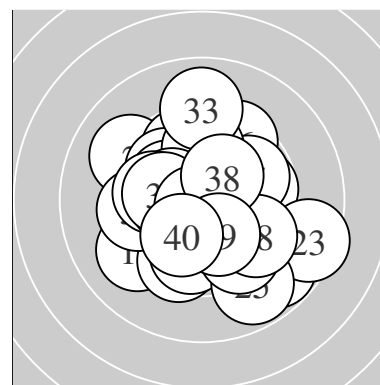

Serie 1:
 10.5 * 9.1 ↖ 9.7 → 9.6 ↙ 10.1 ↓
 9.9 ↘ 9.8 ↗ 8.8 ↘ 10.6 * 9.2 ↙
 beste Teiler 79.4 (9.) 107.7 (1.) 224.3 (5.)
 Trefferlage 0.29 mm links, 0.46 mm tief
 Streuwert 2.47, horizontal: 2.69, vertikal: 2.23

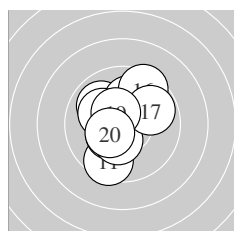

Serie 2:
 9.5 ↓ 9.9 ↖ 10.4 * 10.4 * 10.1 ↑
 9.5 ↗ 9.8 ↗ 10.1 ↖ 10.5 * 10.4 *
 beste Teiler 121.9 (19.) 140.3 (20.) 147.3 (13.)
 Trefferlage 0.34 mm links, 0.37 mm hoch
 Streuwert 1.75, horizontal: 1.52, vertikal: 1.95

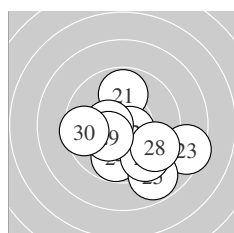

Serie 3:
 9.8 ↑ 10.6 * 8.5 ↘ 9.8 ↓ 8.8 ↘
 9.6 ↘ 10.4 * 9.5 ↘ 10.3 * 9.5 ←
 beste Teiler 88.2 (22.) 128.0 (27.) 163.0 (29.)
 Trefferlage 0.75 mm rechts, 1.37 mm tief
 Streuwert 2.36, horizontal: 2.67, vertikal: 2.00

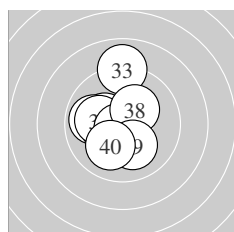

Serie 4:
 10.3 * 9.9 ← 9.0 ↑ 10.3 * 10.3 *
 10.1 ← 10.7 * 10.3 * 10.1 ↓ 10.1 ↓
 beste Teiler 51.6 (37.) 167.5 (34.) 171.8 (38.)
 Trefferlage 0.71 mm links, 0.15 mm hoch
 Streuwert 1.70, horizontal: 1.30, vertikal: 2.03

Unterschrift des Schützen

Meyton Elektronik

Ergebnis: **401.9** (384)
 Serien: 99.8 100.5 99.7 101.9
 Zähler: 24 16 0 0 0 0 0 0 0 0
 Innenzehner: 20
 weiteste: 463 (3), 433 (5), 408 (29)
 beste Teiler 59.3 (8.) 73.3 (4.) 78.4 (9.)
 Trefferlage 0.51 mm rechts, 0.13 mm hoch
 Streuwert 1.71, horizontal: 1.74, vertikal: 1.68

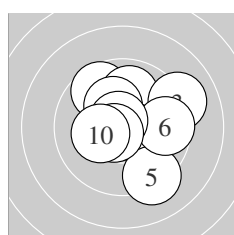
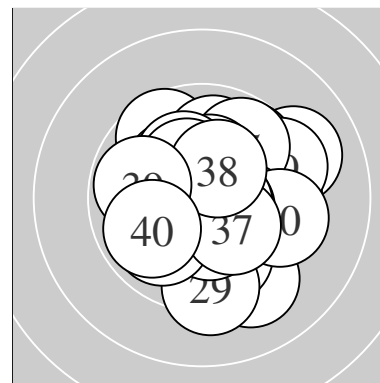

Serie 1:
 9.6 ↘ 9.9 ↑ 9.1 ↗ 10.7 * 9.2 ↘
 9.6 → 10.2 * 10.7 * 10.6 * 10.2 *
 beste Teiler 59.3 (8.) 73.3 (4.) 78.4 (9.)
 Trefferlage 0.57 mm rechts, 0.44 mm hoch
 Streuwert 1.98, horizontal: 2.05, vertikal: 1.91

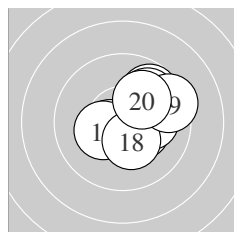

Serie 2:
 10.5 * 10.3 * 9.9 ↗ 10.3 * 9.8 ↗
 9.9 ↗ 10.1 → 10.3 * 9.4 → 10.0 ↗
 beste Teiler 110.9 (11.) 151.3 (12.) 154.3 (18.)
 Trefferlage 1.26 mm rechts, 0.61 mm hoch
 Streuwert 1.43, horizontal: 1.50, vertikal: 1.35

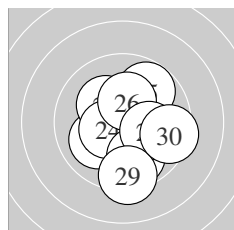

Serie 3:
 10.2 * 10.0 ↙ 10.2 * 10.5 * 9.8 ↗
 10.3 * 9.8 ↘ 10.1 → 9.3 ↓ 9.5 →
 beste Teiler 123.8 (24.) 162.5 (26.) 184.6 (21.)
 Trefferlage 0.61 mm rechts, 0.35 mm tief
 Streuwert 1.87, horizontal: 1.69, vertikal: 2.03

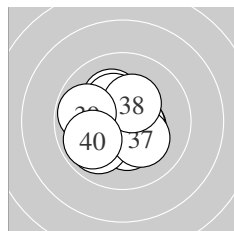

Serie 4:
 10.2 * 10.3 * 9.9 ↙ 10.3 * 10.5 *
 10.5 * 10.2 * 10.3 * 9.8 ← 9.9 ↙
 beste Teiler 103.8 (36.) 118.8 (35.) 153.0 (38.)
 Trefferlage 0.38 mm links, 0.16 mm tief
 Streuwert 1.43, horizontal: 1.51, vertikal: 1.35

Unterschrift des Schützen

Meyton Elektronik