

Ergebnis:	<b>628.0</b>	(600) <sup>QF</sup>
Serien:	104.6	103.8 105.2 104.6 104.0 105.8
Zähler:	60	0 0 0 0 0 0 0 0 0
Innenzehner:	55	
weiteste:	243	(18), 225 (41), 222 (1)
beste Teiler	8.0	(30.) 22.8 (26.) 25.6 (9.)
Trefferlage	0.05 mm	rechts, 0.21 mm hoch
Streuwert	0.95,	horizontal: 0.89, vertikal: 1.00

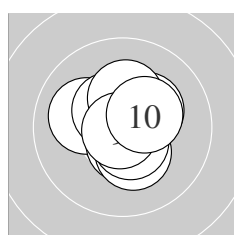

Serie 1:	10.1 ↖	10.6 *	10.6 *	10.3 *	10.5 *
	10.3 *	10.6 *	10.3 *	10.9 *	10.4 *
beste Teiler	25.6	(9.) 81.6 (3.)	96.2 (7.)		
Trefferlage	0.14 mm	rechts, 0.22 mm hoch			
Streuwert	1.02,	horizontal: 1.01, vertikal: 1.04			

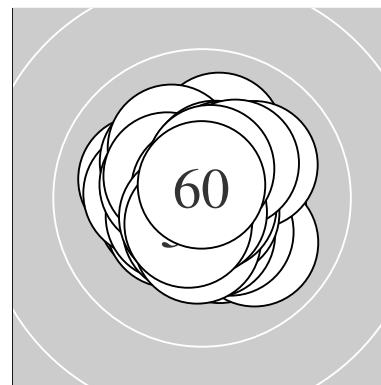
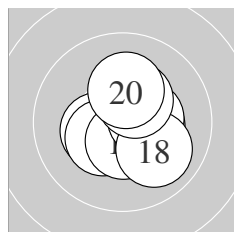

Serie 2:	10.7 *	10.3 *	10.4 *	10.5 *	10.4 *
	10.5 *	10.4 *	10.0 ↘	10.4 *	10.2 *
beste Teiler	57.8	(11.) 111.1 (16.)	122.1 (14.)		
Trefferlage	0.46 mm	rechts, 0.15 mm tief			
Streuwert	1.07,	horizontal: 1.08, vertikal: 1.07			

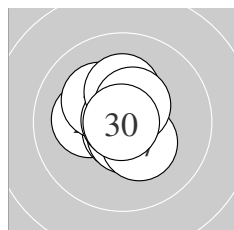

Serie 3:	10.7 *	10.2 *	10.7 *	10.2 *	10.6 *
	10.9 *	10.3 *	10.2 *	10.5 *	10.9 *
beste Teiler	8.0	(30.) 22.8 (26.)	53.6 (23.)		
Trefferlage	0.26 mm	links, 0.18 mm hoch			
Streuwert	0.89,	horizontal: 0.86, vertikal: 0.93			

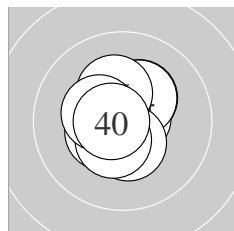

Serie 4:	10.3 *	10.7 *	10.6 *	10.3 *	10.3 *
	10.4 *	10.4 *	10.5 *	10.4 *	10.7 *
beste Teiler	62.9	(32.) 66.0 (40.)	90.3 (33.)		
Trefferlage	0.14 mm	links, 0.10 mm hoch			
Streuwert	0.97,	horizontal: 0.84, vertikal: 1.08			

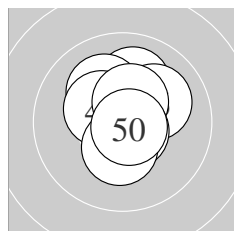

Serie 5:	10.1 ↗	10.5 *	10.5 *	10.1 ↖	10.4 *
	10.1 ↘	10.4 *	10.7 *	10.4 *	10.8 *
beste Teiler	48.4	(50.) 71.5 (48.)	105.0 (43.)		
Trefferlage	0.04 mm	rechts, 0.68 mm hoch			
Streuwert	1.02,	horizontal: 0.91, vertikal: 1.12			

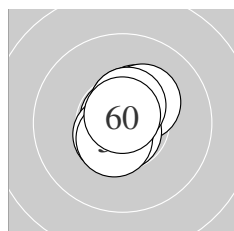

Serie 6:	10.5 *	10.4 *	10.8 *	10.3 *	10.7 *
	10.7 *	10.6 *	10.5 *	10.5 *	10.8 *
beste Teiler	39.0	(53.) 46.0 (60.)	51.1 (55.)		
Trefferlage	0.07 mm	rechts, 0.26 mm hoch			
Streuwert	0.72,	horizontal: 0.58, vertikal: 0.84			

Meyton Elektronik

QF – Schütze hat sich fürs Finale qualifiziert

---

Unterschrift des Schützen

Meyton Elektronik

Ergebnis: **609.2** (578)

Serien: 101.9 103.0 104.3 101.5 104.3 94.2

Zähler: 45 14 0 0 0 0 0 0 1 0

Innenzehner: 39

weiteste: 2055 (53), 458 (4), 363 (32)

beste Teiler 12.7 (14.) 18.0 (19.) 19.6 (46.)

Trefferlage 0.50 mm rechts, 0.05 mm hoch

Streuwert 2.31, horizontal: 1.48, vertikal: 2.91

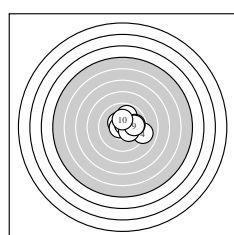
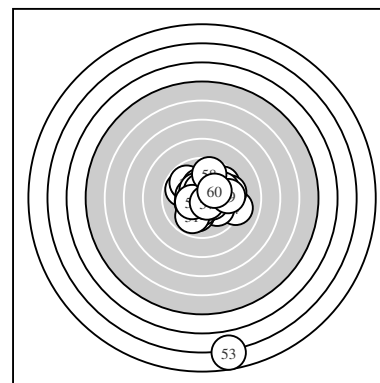

Serie 1:

10.4 *	10.7 *	10.7 *	9.1 ↘	10.7 *
9.9 ↗	10.3 *	9.9 →	9.9 →	10.3 *

beste Teiler 62.0 (2.) 68.3 (3.) 75.4 (5.)

Trefferlage 1.06 mm rechts, 0.50 mm hoch

Streuwert 1.43, horizontal: 1.70, vertikal: 1.10

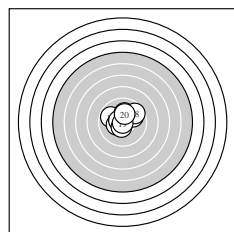

Serie 2:

9.8 ↖	10.1 ↗	10.4 *	10.9 *	10.6 *
10.5 *	9.9 ↘	9.7 ↗	10.9 *	10.2 *

beste Teiler 12.7 (14.) 18.0 (19.) 86.5 (15.)

Trefferlage 0.07 mm rechts, 0.63 mm hoch

Streuwert 1.34, horizontal: 1.55, vertikal: 1.09

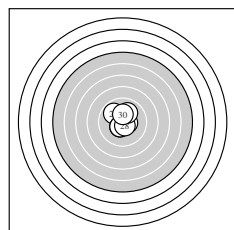

Serie 3:

10.6 *	10.5 *	10.5 *	10.8 *	9.9 ↖
10.5 *	10.5 *	10.6 *	10.1 ↗	10.3 *

beste Teiler 26.5 (24.) 82.7 (21.) 89.5 (28.)

Trefferlage 0.01 mm links, 0.44 mm hoch

Streuwert 1.05, horizontal: 0.89, vertikal: 1.20

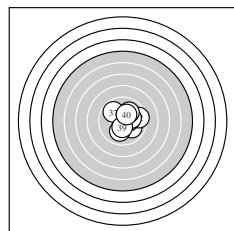

Serie 4:

10.0 ↖	9.5 →	10.3 *	10.9 *	10.2 *
10.0 ↗	9.8 ↖	10.1 ↓	10.4 *	10.3 *

beste Teiler 22.3 (34.) 135.2 (39.) 161.4 (33.)

Trefferlage 0.85 mm rechts, 0.22 mm hoch

Streuwert 1.51, horizontal: 1.57, vertikal: 1.44

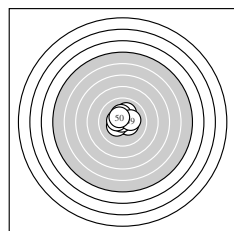

Serie 5:

10.1 ↗	10.6 *	10.6 *	10.4 *	10.3 *
10.9 *	10.4 *	10.3 *	10.2 *	10.5 *

beste Teiler 19.6 (46.) 82.8 (42.) 98.1 (43.)

Trefferlage 0.00 mm , 0.31 mm hoch

Streuwert 1.01, horizontal: 1.07, vertikal: 0.95

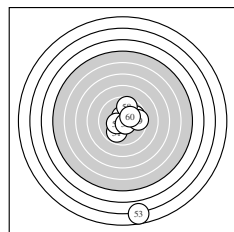

Serie 6:

9.9 ↓	10.7 *	2.7 ↓	10.6 *	10.4 *
9.8 →	10.6 *	9.7 ↗	9.6 →	10.2 *

beste Teiler 68.2 (52.) 87.7 (57.) 99.7 (54.)

Trefferlage 1.04 mm rechts, 1.79 mm tief

Streuwert 4.86, horizontal: 1.74, vertikal: 6.65

Meyton Elektronik

**ISSF AR Women – Wertung – Frauen**

StandNr: 107

**Kitzbichler, Jasmin #82**

**StartNr: 36**

1. Dezember 2019 11:37

AUT

---

\_\_\_\_\_  
Unterschrift des Schützen

Meyton Elektronik

Ergebnis: **604.7** (581)  
 Serien: 102.0 101.3 102.0 99.0 101.5 98.9  
 Zähler: 43 15 2 0 0 0 0 0 0  
 Innenzehner: 34  
 weiteste: 623 (46), 536 (51), 469 (11)  
 beste Teiler 42.4 (4.) 74.0 (45.) 78.7 (23.)  
 Trefferlage 0.57 mm links, 0.08 mm tief  
 Streuwert 1.73, horizontal: 1.92, vertikal: 1.50

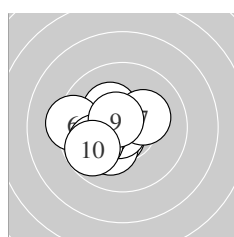
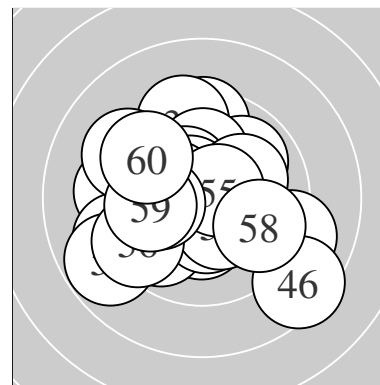

Serie 1:  
 10.6 \* 10.2 \* 10.3 \* 10.8 \* 10.2 \*  
 9.3 ← 10.2 \* 10.0 ↙ 10.6 \* 9.8 ↙  
 beste Teiler 42.4 (4.) 80.7 (9.) 89.5 (1.)  
 Trefferlage 1.20 mm links, 0.30 mm tief  
 Streuwert 1.31, horizontal: 1.52, vertikal: 1.06

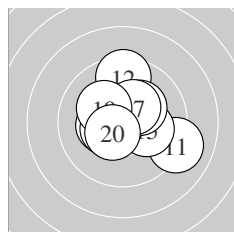

Serie 2:  
 9.1 ↘ 9.5 ↑ 10.3 \* 10.6 \* 10.1 →  
 10.2 \* 10.4 \* 10.4 \* 10.2 \* 10.5 \*  
 beste Teiler 98.8 (14.) 117.3 (20.) 132.0 (18.)  
 Trefferlage 0.26 mm rechts, 0.24 mm hoch  
 Streuwert 1.72, horizontal: 1.87, vertikal: 1.56

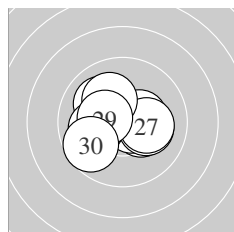

Serie 3:  
 10.3 \* 10.0 ↘ 10.6 \* 10.4 \* 10.2 \*  
 10.1 ← 10.2 \* 10.1 ↘ 10.4 \* 9.7 ↙  
 beste Teiler 78.7 (23.) 141.9 (24.) 147.9 (29.)  
 Trefferlage 0.15 mm links, 0.00 mm  
 Streuwert 1.48, horizontal: 1.81, vertikal: 1.04

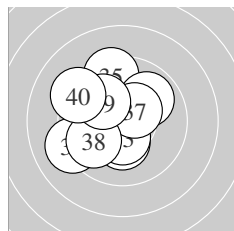

Serie 4:  
 10.3 \* 10.2 \* 10.4 \* 9.2 ↙ 9.4 ↑  
 9.9 ↗ 10.4 \* 9.8 ↙ 10.1 ↘ 9.3 ↘  
 beste Teiler 129.6 (37.) 131.0 (33.) 172.0 (31.)  
 Trefferlage 1.11 mm links, 0.23 mm hoch  
 Streuwert 1.96, horizontal: 1.91, vertikal: 2.00

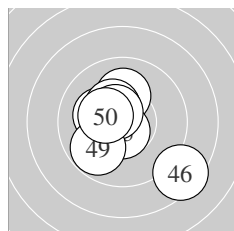

Serie 5:  
 10.1 ↑ 10.2 \* 10.4 \* 10.4 \* 10.7 \*  
 8.5 ↘ 10.4 \* 10.6 \* 9.8 ↙ 10.4 \*  
 beste Teiler 74.0 (45.) 98.6 (48.) 132.8 (43.)  
 Trefferlage 0.39 mm links, 0.02 mm tief  
 Streuwert 1.87, horizontal: 1.91, vertikal: 1.83

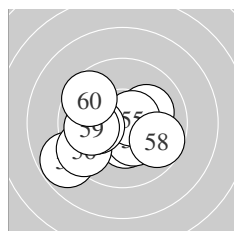

Serie 6:  
 8.8 ↙ 10.1 ↗ 10.4 \* 10.3 \* 10.6 \*  
 9.4 ↙ 10.1 ← 9.7 ↘ 9.9 ← 9.6 ↘  
 beste Teiler 86.3 (55.) 143.6 (53.) 152.6 (54.)  
 Trefferlage 0.82 mm links, 0.65 mm tief  
 Streuwert 2.02, horizontal: 2.44, vertikal: 1.47

**ISSF AR Women – Wertung – Frauen**

StandNr: 108

**Vanoni, Larissa** #111

**StartNr: 37**

1. Dezember 2019 11:21

LIE

---

\_\_\_\_\_  
Unterschrift des Schützen

Meyton Elektronik

Ergebnis:	<b>626.7</b>	(598) <sup>QF</sup>						
Serien:	105.2	103.2	105.1	102.9	105.4	104.9		
Zähler:	58	2	0	0	0	0	0	0
Innenzehner:	50							
weiteste:	385 (13), 275 (24), 239 (37)							
beste Teiler	10.0 (59.) 20.0 (29.) 26.0 (18.)							
Trefferlage	0.06 mm rechts, 0.27 mm hoch							
Streuwert	1.01, horizontal: 0.97, vertikal: 1.04							

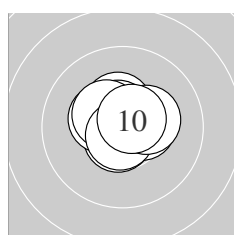
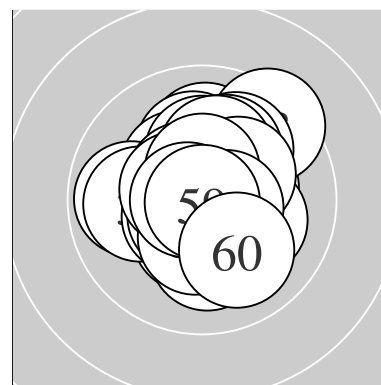

Serie 1:	10.7 *	10.4 *	10.6 *	10.6 *	10.5 *
	10.4 *	10.4 *	10.7 *	10.3 *	10.6 *
beste Teiler	56.6 (8.) 74.3 (1.) 79.9 (10.)				
Trefferlage	0.03 mm links, 0.42 mm hoch				
Streuwert	0.78, horizontal: 0.91, vertikal: 0.63				

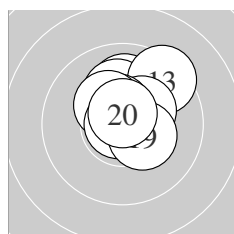

Serie 2:	10.0 ↑	10.1 ↑	9.4 ↗	10.7 *	10.3 *
	10.5 *	10.3 *	10.8 *	10.4 *	10.7 *
beste Teiler	26.0 (18.) 61.5 (14.) 71.0 (20.)				
Trefferlage	0.32 mm rechts, 1.09 mm hoch				
Streuwert	1.07, horizontal: 1.05, vertikal: 1.08				

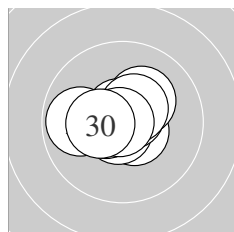

Serie 3:	10.6 *	10.2 *	10.7 *	9.9 ←	10.7 *
	10.7 *	10.5 *	10.5 *	10.9 *	10.4 *
beste Teiler	20.0 (29.) 57.8 (23.) 62.2 (26.)				
Trefferlage	0.27 mm links, 0.21 mm hoch				
Streuwert	0.96, horizontal: 1.20, vertikal: 0.62				

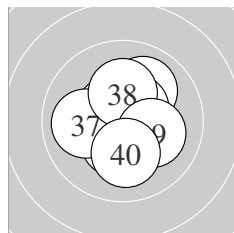

Serie 4:	10.7 *	10.0 ↗	10.5 *	10.4 *	10.4 *
	10.5 *	10.0 ←	10.2 *	10.1 ↘	10.1 ↓
beste Teiler	65.6 (31.) 102.1 (36.) 111.0 (33.)				
Trefferlage	0.07 mm rechts, 0.09 mm tief				
Streuwert	1.28, horizontal: 1.18, vertikal: 1.37				

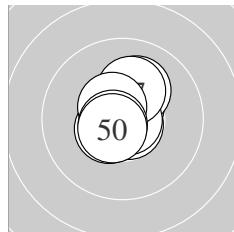

Serie 5:	10.8 *	10.7 *	10.5 *	10.5 *	10.1 ↗
	10.8 *	10.2 *	10.5 *	10.7 *	10.6 *
beste Teiler	33.9 (46.) 48.3 (41.) 55.1 (42.)				
Trefferlage	0.04 mm links, 0.28 mm hoch				
Streuwert	0.83, horizontal: 0.65, vertikal: 0.98				

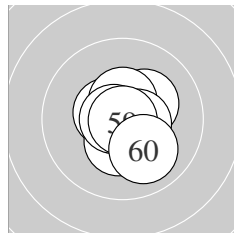

Serie 6:	10.7 *	10.3 *	10.5 *	10.3 *	10.4 *
	10.5 *	10.6 *	10.7 *	10.9 *	10.0 ↘
beste Teiler	10.0 (59.) 57.0 (58.) 67.7 (51.)				
Trefferlage	0.35 mm rechts, 0.26 mm tief				
Streuwert	0.93, horizontal: 0.83, vertikal: 1.02				

Meyton Elektronik

**ISSF AR Women – Wertung – Frauen**

StandNr: 109

**Pribitzer, Marlene #38**

**StartNr: 38**

1. Dezember 2019 11:34

AUT

---

QF – Schütze hat sich fürs Finale qualifiziert

---

Unterschrift des Schützen

Meyton Elektronik



Ergebnis:	<b>628.4</b>	(597) <sup>QF</sup>					
Serien:	104.0	104.4	105.7	105.5	103.9	104.9	
Zähler:	57	3	0	0	0	0	0
Innenzehner:	55						
weiteste:	274 (58), 266 (46), 260 (8)						
beste Teiler	6.4 (24.) 28.2 (59.) 31.2 (45.)						
Trefferlage	0.28 mm rechts, 0.02 mm hoch						
Streuwert	0.94, horizontal: 0.99, vertikal: 0.89						

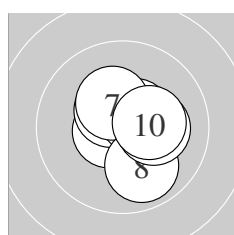
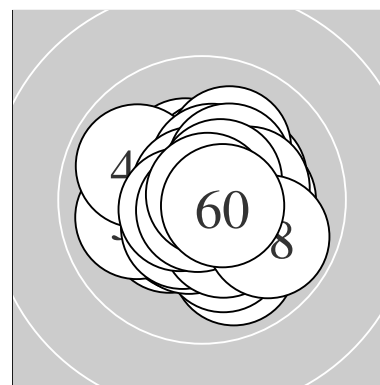

Serie 1:	10.3 *	10.8 *	10.6 *	10.6 *	10.5 *
	10.5 *	10.3 *	9.9 ↘	10.2 *	10.3 *
beste Teiler	45.9 (2.) 84.2 (3.) 84.3 (4.)				
Trefferlage	0.59 mm rechts, 0.07 mm hoch				
Streuwert	1.02, horizontal: 1.02, vertikal: 1.03				

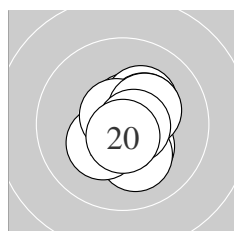

Serie 2:	10.3 *	10.6 *	10.2 *	10.3 *	10.3 *
	10.3 *	10.7 *	10.3 *	10.7 *	10.7 *
beste Teiler	64.4 (17.) 68.2 (19.) 74.0 (20.)				
Trefferlage	0.48 mm rechts, 0.08 mm tief				
Streuwert	0.98, horizontal: 0.81, vertikal: 1.12				

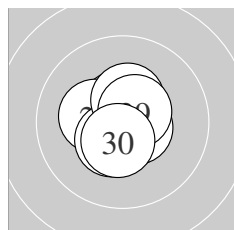

Serie 3:	10.6 *	10.7 *	10.7 *	10.9 *	10.6 *
	10.3 *	10.4 *	10.4 *	10.6 *	10.5 *
beste Teiler	6.4 (24.) 57.2 (22.) 68.0 (23.)				
Trefferlage	0.07 mm links, 0.02 mm tief				
Streuwert	0.78, horizontal: 0.74, vertikal: 0.82				

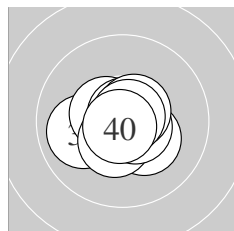

Serie 4:	10.3 *	10.0 ←	10.5 *	10.7 *	10.4 *
	10.6 *	10.8 *	10.6 *	10.8 *	10.8 *
beste Teiler	37.5 (40.) 39.0 (37.) 44.0 (39.)				
Trefferlage	0.04 mm links, 0.22 mm tief				
Streuwert	0.87, horizontal: 1.05, vertikal: 0.63				

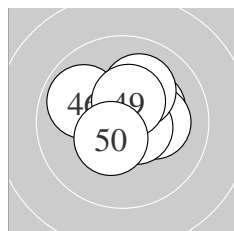

Serie 5:	10.2 *	10.5 *	10.2 *	10.7 *	10.8 *
	9.9 ↘	10.6 *	10.1 ↗	10.4 *	10.5 *
beste Teiler	31.2 (45.) 74.2 (44.) 87.4 (47.)				
Trefferlage	0.13 mm rechts, 0.45 mm hoch				
Streuwert	1.11, horizontal: 1.29, vertikal: 0.88				

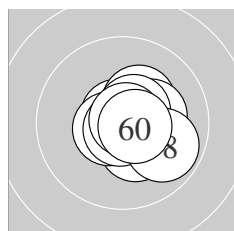

Serie 6:	10.3 *	10.7 *	10.3 *	10.3 *	10.6 *
	10.8 *	10.6 *	9.9 ↘	10.8 *	10.6 *
beste Teiler	28.2 (59.) 41.2 (56.) 52.8 (52.)				
Trefferlage	0.61 mm rechts, 0.05 mm tief				
Streuwert	0.90, horizontal: 0.95, vertikal: 0.84				

Meyton Elektronik

**ISSF AR Women – Wertung – Frauen**

StandNr: 112

**Brabcova, Aneta #29**

**StartNr: 40**

1. Dezember 2019 11:27

CZE

---

QF – Schütze hat sich fürs Finale qualifiziert

---

Unterschrift des Schützen

Meyton Elektronik

Ergebnis:	<b>603.8</b>	(574)							
Serien:	102.8	100.3	98.1	99.2	100.7	102.7			
Zähler:	35	24	1	0	0	0	0	0	0
Innenzehner:	29								
weiteste:	513 (26), 460 (28), 454 (39)								
beste Teiler	29.7 (9.)	41.2 (19.)	45.7 (16.)						
Trefferlage	0.17 mm rechts, 0.58 mm hoch								
Streuwert	1.77, horizontal: 1.90, vertikal: 1.63								

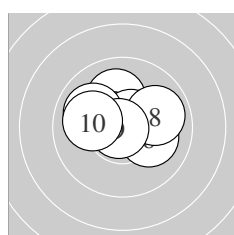
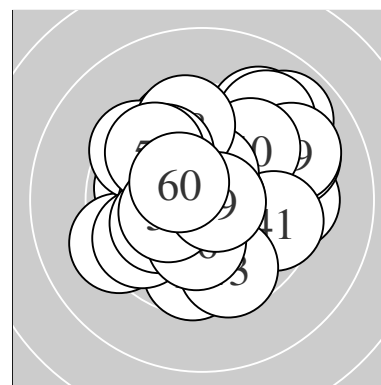

Serie 1:	10.6 *	10.1 ↑	10.2 *	10.5 *	10.6 *
	10.1 →	10.0 ↖	9.9 →	10.8 *	10.0 ←
beste Teiler	29.7 (9.)	86.3 (5.)	99.5 (1.)		
Trefferlage	0.37 mm rechts, 0.51 mm hoch				
Streuwert	1.29, horizontal: 1.66, vertikal: 0.77				

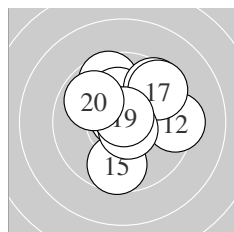

Serie 2:	9.7 ↑	9.4 →	10.2 *	9.6 ↗	9.7 ↓
	10.8 *	9.5 ↗	10.7 *	10.8 *	9.9 ↖
beste Teiler	41.2 (19.)	45.7 (16.)	67.0 (18.)		
Trefferlage	0.52 mm rechts, 0.86 mm hoch				
Streuwert	1.87, horizontal: 1.87, vertikal: 1.87				

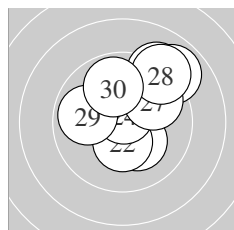

Serie 3:	10.2 *	10.4 *	10.1 ↑	10.7 *	9.1 ↗
	8.9 ↗	9.8 ↗	9.1 ↗	9.9 ←	9.9 ↑
beste Teiler	60.8 (24.)	148.0 (22.)	179.4 (21.)		
Trefferlage	0.95 mm rechts, 1.57 mm hoch				
Streuwert	1.94, horizontal: 1.92, vertikal: 1.96				

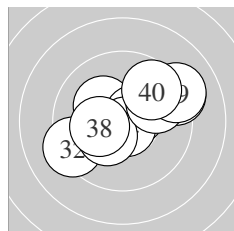

Serie 4:	10.2 *	9.3 ↖	10.6 *	10.8 *	10.3 *
	9.2 →	9.8 →	10.2 *	9.1 →	9.7 ↗
beste Teiler	49.7 (34.)	99.7 (33.)	159.1 (35.)		
Trefferlage	0.57 mm rechts, 0.54 mm hoch				
Streuwert	2.12, horizontal: 2.61, vertikal: 1.47				

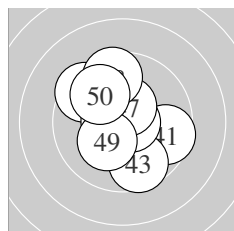

Serie 5:	9.6 →	10.5 *	9.6 ↓	9.5 ↖	10.6 *
	10.7 *	10.5 *	9.6 ↑	10.2 *	9.9 ↖
beste Teiler	60.0 (46.)	88.2 (45.)	108.4 (42.)		
Trefferlage	0.25 mm links, 0.44 mm hoch				
Streuwert	1.81, horizontal: 1.69, vertikal: 1.92				

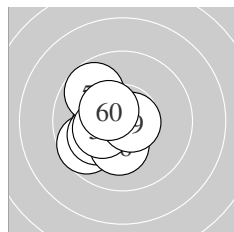

Serie 6:	9.7 ↖	10.3 *	10.7 *	10.1 ↖	10.6 *
	10.2 *	9.7 ↖	10.3 *	10.7 *	10.4 *
beste Teiler	61.1 (53.)	63.6 (59.)	94.3 (55.)		
Trefferlage	1.09 mm links, 0.39 mm tief				
Streuwert	1.12, horizontal: 1.05, vertikal: 1.18				

Meyton Elektronik

**ISSF AR Women – Wertung – Frauen**

StandNr: 113

**Petermair, Doris #112**

**StartNr: 41**

1. Dezember 2019 11:16

OOE – Enns

---

\_\_\_\_\_  
Unterschrift des Schützen

Meyton Elektronik

Ergebnis:	<b>626.4</b>	(597) <sup>QF</sup>							
Serien:	103.9	102.6	105.5	105.6	104.8	104.0			
Zähler:	57	3	0	0	0	0	0	0	0
Innenzehner:	52								
weiteste:	331 (57), 310 (11), 276 (9)								
beste Teiler	20.2 (27.)	26.4 (33.)	30.5 (16.)						
Trefferlage	0.06 mm links, 0.30 mm hoch								
Streuwert	1.00, horizontal: 1.03, vertikal: 0.97								

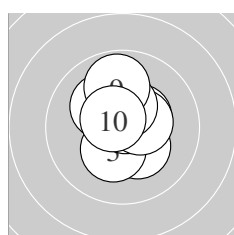
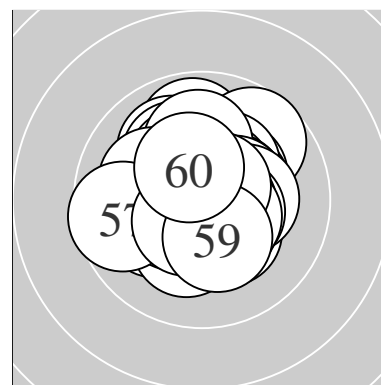

Serie 1:	10.3 *	10.6 *	10.3 *	10.8 *	10.2 *
	10.4 *	10.5 *	10.4 *	9.8 ↑	10.6 *
beste Teiler	48.3 (4.)	87.2 (10.)	92.6 (2.)		
Trefferlage	0.00 mm , 0.55 mm hoch				
Streuwert	1.08, horizontal: 0.89, vertikal: 1.25				

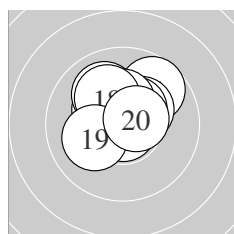

Serie 2:	9.7 ↗	10.3 *	10.0 ↘	10.3 *	10.4 *
	10.8 *	10.3 *	10.1 ↘	10.1 ←	10.6 *
beste Teiler	30.5 (16.)	99.1 (20.)	128.2 (15.)		
Trefferlage	0.03 mm links, 0.98 mm hoch				
Streuwert	1.17, horizontal: 1.28, vertikal: 1.03				

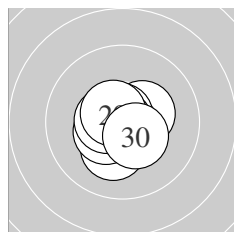

Serie 3:	10.6 *	10.7 *	10.4 *	10.2 *	10.8 *
	10.4 *	10.9 *	10.5 *	10.6 *	10.4 *
beste Teiler	20.2 (27.)	45.3 (25.)	52.4 (22.)		
Trefferlage	0.02 mm links, 0.19 mm tief				
Streuwert	0.81, horizontal: 0.87, vertikal: 0.74				

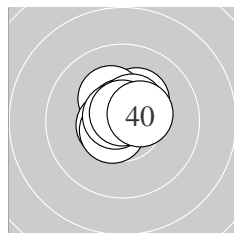

Serie 4:	10.3 *	10.3 *	10.8 *	10.6 *	10.7 *
	10.5 *	10.6 *	10.7 *	10.7 *	10.4 *
beste Teiler	26.4 (33.)	55.0 (39.)	59.0 (38.)		
Trefferlage	0.01 mm links, 0.51 mm hoch				
Streuwert	0.71, horizontal: 0.75, vertikal: 0.67				

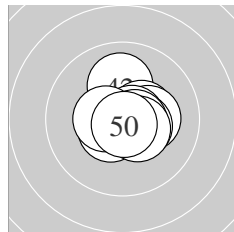

Serie 5:	10.5 *	10.0 ↑	10.4 *	10.3 *	10.5 *
	10.7 *	10.5 *	10.6 *	10.5 *	10.8 *
beste Teiler	38.6 (50.)	63.1 (46.)	86.4 (48.)		
Trefferlage	0.46 mm rechts, 0.03 mm hoch				
Streuwert	0.90, horizontal: 0.94, vertikal: 0.86				

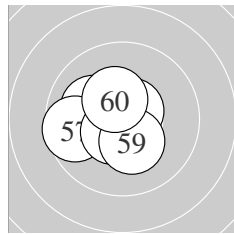

Serie 6:	10.5 *	10.7 *	10.8 *	10.5 *	10.1 ↘
	10.6 *	9.6 ←	10.5 *	10.3 *	10.4 *
beste Teiler	40.8 (53.)	51.4 (52.)	79.2 (56.)		
Trefferlage	0.76 mm links, 0.06 mm tief				
Streuwert	1.04, horizontal: 1.20, vertikal: 0.85				

Meyton Elektronik

**ISSF AR Women – Wertung – Frauen**

StandNr: 114

**Köck, Rebecca** #44

**StartNr: 42**

1. Dezember 2019 11:37

AUT

---

QF – Schütze hat sich fürs Finale qualifiziert

---

Unterschrift des Schützen

Meyton Elektronik

Ergebnis:	<b>606.0</b>	(580)
Serien:	98.8	103.2 102.8 98.0 101.2 102.0
Zähler:	40	20 0 0 0 0 0 0 0 0
Innenzehner:	33	
weiteste:	487 (47), 460 (50), 459 (39)	
beste Teiler	35.6 (48.)	54.0 (24.) 56.5 (38.)
Trefferlage	0.08 mm links, 0.22 mm hoch	
Streuwert	1.74, horizontal: 2.10, vertikal: 1.27	

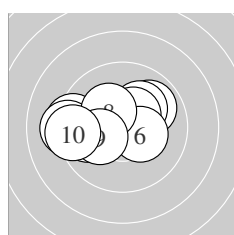
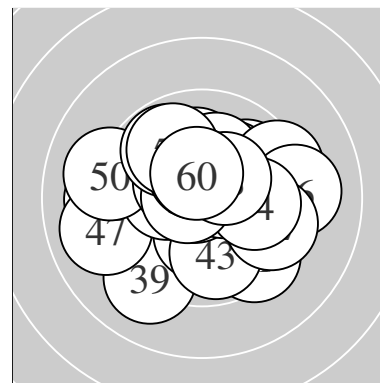

Serie 1:	9.9 ↗	9.8 ←	10.1 ↗	10.4 *	9.3 ←
	10.3 *	9.2 ←	10.3 *	10.2 *	9.3 ←
beste Teiler	130.4 (4.) 153.0 (6.) 171.5 (8.)				
Trefferlage	1.24 mm links, 0.33 mm hoch				
Streuwert	1.91, horizontal: 2.54, vertikal: 0.93				

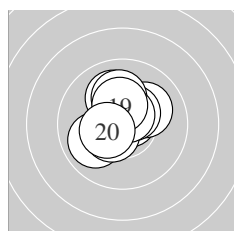

Serie 2:	9.9 ↙	10.7 *	10.5 *	10.1 ↗	10.1 ↖
	10.5 *	10.1 ↑	10.6 *	10.3 *	10.4 *
beste Teiler	65.8 (12.) 82.7 (18.) 118.8 (13.)				
Trefferlage	0.21 mm links, 0.63 mm hoch				
Streuwert	1.16, horizontal: 1.13, vertikal: 1.19				

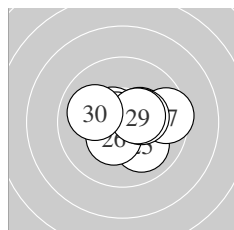

Serie 3:	10.6 *	10.4 *	10.5 *	10.7 *	10.0 ↘
	10.4 *	9.5 →	10.3 *	10.4 *	10.0 ↖
beste Teiler	54.0 (24.) 99.6 (21.) 122.3 (23.)				
Trefferlage	0.57 mm rechts, 0.03 mm tief				
Streuwert	1.32, horizontal: 1.64, vertikal: 0.91				

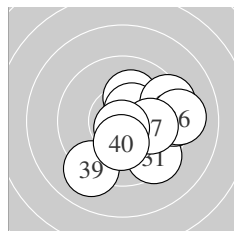

Serie 4:	9.4 ↘	10.2 *	9.3 →	10.5 *	9.4 →
	9.1 →	10.0 →	10.7 *	9.1 ↙	10.3 *
beste Teiler	56.5 (38.) 111.1 (34.) 173.3 (40.)				
Trefferlage	1.57 mm rechts, 0.45 mm tief				
Streuwert	2.04, horizontal: 2.23, vertikal: 1.84				

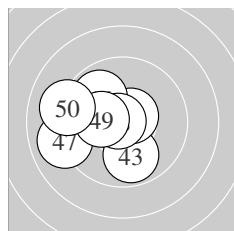

Serie 5:	10.3 *	10.7 *	9.9 ↓	10.6 *	10.6 *
	9.9 ↘	9.0 ←	10.8 *	10.3 *	9.1 ←
beste Teiler	35.6 (48.) 60.0 (42.) 81.4 (45.)				
Trefferlage	1.45 mm links, 0.08 mm hoch				
Streuwert	1.60, horizontal: 1.85, vertikal: 1.30				

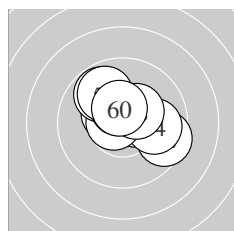

Serie 6:	10.5 *	9.5 →	10.4 *	9.9 →	10.7 *
	9.8 ↘	10.4 *	10.4 *	9.9 ↖	10.5 *
beste Teiler	71.2 (55.) 109.2 (51.) 121.8 (60.)				
Trefferlage	0.25 mm rechts, 0.75 mm hoch				
Streuwert	1.44, horizontal: 1.71, vertikal: 1.11				

**ISSF AR Women – Wertung – Frauen**

StandNr: 115

**Mautz, Leonie** #109

**StartNr: 43**

1. Dezember 2019 11:25

LIE

---

\_\_\_\_\_  
Unterschrift des Schützen

Meyton Elektronik



Ergebnis:	<b>589.5</b>	(564)					
Serien:	97.4	98.0	98.6	99.7	95.9	99.9	
Zähler:	31	24	3	2	0	0	0
Innenzehner:	19						
weiteste:	898 (47), 760 (28), 604 (10)						
beste Teiler	18.6 (3.) 38.2 (52.) 59.0 (25.)						
Trefferlage	0.04 mm links, 0.26 mm tief						
Streuwert	2.32, horizontal: 2.76, vertikal: 1.78						

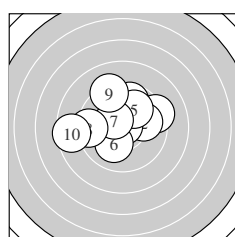
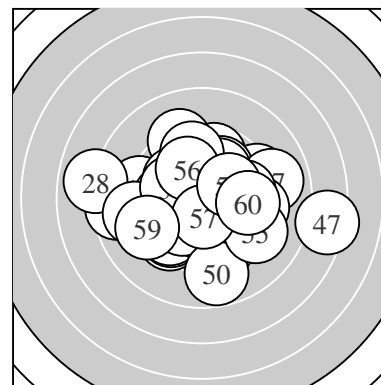

Serie 1:

9.3 →	9.9 →	10.9 *	9.7 ↑	10.0 ↗
10.1 ↘	10.4 *	9.4 ←	9.2 ↖	8.5 ←
beste Teiler	18.6 (3.) 130.4 (7.) 215.6 (6.)			
Trefferlage	0.49 mm links, 0.96 mm hoch			
Streuwert	2.42, horizontal: 2.93, vertikal: 1.77			

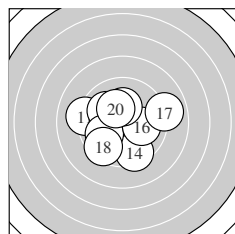

Serie 2:

9.2 ←	10.7 *	10.0 ↘	9.4 ↘	9.9 ↖
10.0 →	8.9 →	9.5 ↙	10.2 *	10.2 *
beste Teiler	74.2 (12.) 177.5 (20.) 180.0 (19.)			
Trefferlage	0.23 mm links, 0.19 mm tief			
Streuwert	2.31, horizontal: 2.68, vertikal: 1.89			

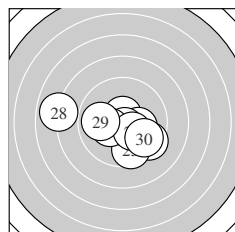

Serie 3:

9.4 ↘	10.6 *	9.6 ↘	10.2 *	10.7 *
10.3 *	10.3 *	7.9 ←	9.9 ←	9.7 ↘
beste Teiler	59.0 (25.) 78.0 (22.) 156.3 (27.)			
Trefferlage	0.18 mm links, 0.80 mm tief			
Streuwert	2.39, horizontal: 3.10, vertikal: 1.35			

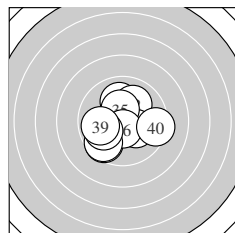

Serie 4:

10.0 ↑	10.0 ↗	9.6 ↙	10.2 *	10.4 *
10.6 *	9.6 ↙	10.0 ←	9.9 ←	9.4 →
beste Teiler	92.0 (36.) 142.9 (35.) 179.6 (34.)			
Trefferlage	0.32 mm links, 0.36 mm tief			
Streuwert	1.92, horizontal: 2.10, vertikal: 1.72			

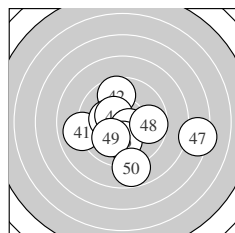

Serie 5:

9.0 ←	9.7 ↑	10.2 *	10.4 *	10.6 *
10.1 ↓	7.4 →	9.7 →	10.0 ↙	8.8 ↘
beste Teiler	100.4 (45.) 128.0 (44.) 176.5 (43.)			
Trefferlage	0.41 mm rechts, 0.88 mm tief			
Streuwert	2.98, horizontal: 3.59, vertikal: 2.21			

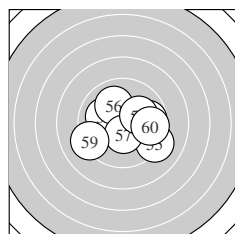

Serie 6:

9.8 →	10.8 *	10.6 *	10.1 ↖	9.2 ↘
10.0 ↘	10.4 *	10.1 →	9.2 ←	9.7 →
beste Teiler	38.2 (52.) 85.7 (53.) 133.4 (57.)			
Trefferlage	0.55 mm rechts, 0.29 mm tief			
Streuwert	2.00, horizontal: 2.47, vertikal: 1.39			

Meyton Elektronik

**ISSF AR Women – Wertung – Frauen**

StandNr: 116

**Anlanger, Beatrice Carina #117**

**StartNr: 44**

1. Dezember 2019 11:06

OOE – Laakirchen

---

\_\_\_\_\_  
Unterschrift des Schützen

Meyton Elektronik

Ergebnis:	<b>609.0</b>	(583)							
Serien:	100.9	103.4	100.6	102.5	100.0	101.6			
Zähler:	43	17	0	0	0	0	0	0	0
Innenzehner:	33								
weiteste:	476 (47), 443 (5), 443 (60)								
beste Teiler	39.2 (8.)	53.8 (46.)	65.9 (31.)						
Trefferlage	0.08 mm rechts, 0.10 mm hoch								
Streuwert	1.59, horizontal: 1.61, vertikal: 1.57								

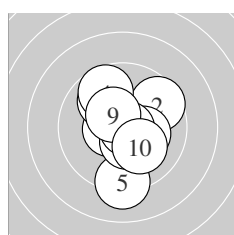
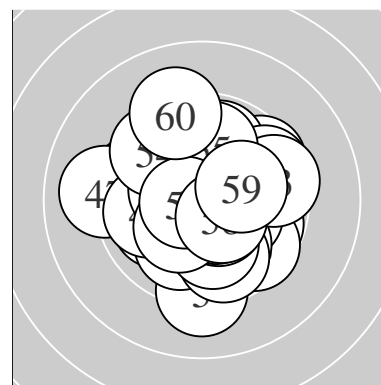

Serie 1:	10.5 *	9.6 ↗	9.9 ↖	9.7 ↖	9.2 ↓
	10.5 *	10.2 *	10.8 *	10.4 *	10.1 ↘
beste Teiler	39.2 (8.)	104.2 (1.)	124.6 (6.)		
Trefferlage	0.20 mm rechts, 0.01 mm tief				
Streuwert	1.82, horizontal: 1.43, vertikal: 2.13				

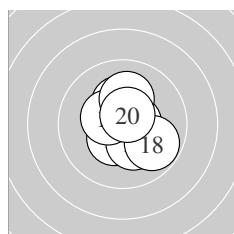

Serie 2:	10.6 *	10.3 *	10.3 *	10.6 *	10.4 *
	10.3 *	10.4 *	9.8 ↘	10.1 ↑	10.6 *
beste Teiler	80.2 (14.)	85.4 (20.)	93.4 (11.)		
Trefferlage	0.42 mm rechts, 0.08 mm tief				
Streuwert	1.17, horizontal: 1.01, vertikal: 1.31				

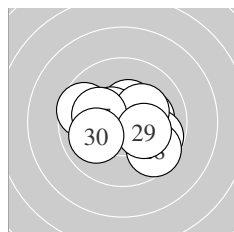

Serie 3:	10.4 *	10.1 →	9.6 ↖	9.8 ↘	10.5 *
	10.2 *	10.2 *	9.6 ↘	10.2 *	10.0 ↖
beste Teiler	110.9 (25.)	130.3 (21.)	178.2 (26.)		
Trefferlage	0.28 mm rechts, 0.05 mm tief				
Streuwert	1.73, horizontal: 2.15, vertikal: 1.16				

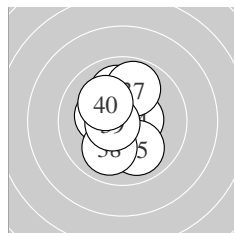

Serie 4:	10.7 *	10.3 *	10.4 *	10.5 *	10.0 ↓
	10.0 ↑	9.9 ↑	10.0 ↓	10.6 *	10.1 ↖
beste Teiler	65.9 (31.)	85.1 (39.)	111.5 (34.)		
Trefferlage	0.27 mm links, 0.29 mm hoch				
Streuwert	1.39, horizontal: 1.07, vertikal: 1.65				

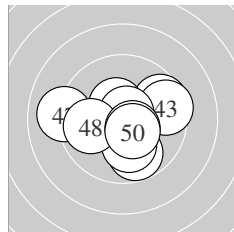

Serie 5:	9.6 ↗	9.8 ↓	9.5 →	10.5 *	10.1 ↓
	10.7 *	9.0 ←	9.9 ←	10.5 *	10.4 *
beste Teiler	53.8 (46.)	110.3 (49.)	123.4 (44.)		
Trefferlage	0.22 mm rechts, 0.29 mm tief				
Streuwert	1.99, horizontal: 2.44, vertikal: 1.40				

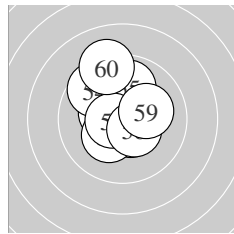

Serie 6:	10.5 *	10.6 *	10.4 *	9.6 ↖	9.9 ↑
	10.3 *	10.6 *	10.4 *	10.1 →	9.2 ↖
beste Teiler	83.0 (57.)	96.5 (52.)	110.2 (51.)		
Trefferlage	0.36 mm links, 0.77 mm hoch				
Streuwert	1.56, horizontal: 1.30, vertikal: 1.78				

Meyton Elektronik

**ISSF AR Women – Wertung – Frauen**

StandNr: 117

**Klingler, Lea** #211

**StartNr: 45**

1. Dezember 2019 11:10

T – SG Kramsach

---

\_\_\_\_\_  
Unterschrift des Schützen

Meyton Elektronik

Ergebnis:	<b>624.3</b>	(596) <sup>QF</sup>
Serien:	104.4	104.1 104.6 103.8 104.5 102.9
Zähler:	56	4 0 0 0 0 0 0 0 0
Innenzehner:	53	
weiteste:	295	(36), 294 (18), 259 (1)
beste Teiler	41.2	(8.) 51.1 (26.) 56.0 (28.)
Trefferlage	0.13 mm	rechts, 0.35 mm hoch
Streuwert	1.02,	horizontal: 1.00, vertikal: 1.04

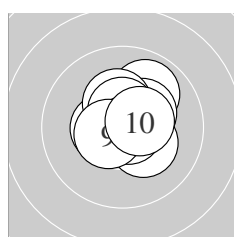
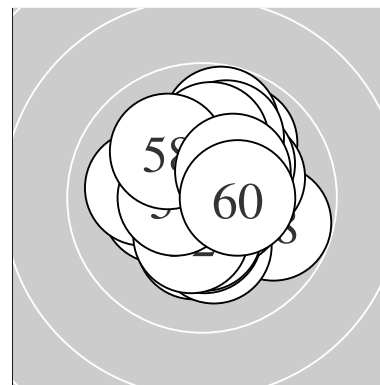

Serie 1:	9.9 ↗	10.7 *	10.5 *	10.3 *	10.3 *
	10.6 *	10.3 *	10.8 *	10.5 *	10.5 *
beste Teiler	41.2	(8.) 60.0 (2.)	99.0 (6.)		
Trefferlage	0.24 mm	rechts, 0.43 mm	hoch		
Streuwert	0.98,	horizontal: 1.00, vertikal: 0.96			

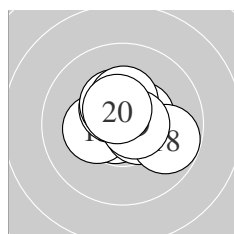

Serie 2:	10.7 *	10.5 *	10.3 *	10.5 *	10.5 *
	10.4 *	10.3 *	9.8 ↘	10.6 *	10.5 *
beste Teiler	56.3	(11.) 81.0 (19.)	104.0 (20.)		
Trefferlage	0.22 mm	rechts, 0.33 mm	hoch		
Streuwert	1.07,	horizontal: 1.25, vertikal: 0.84			

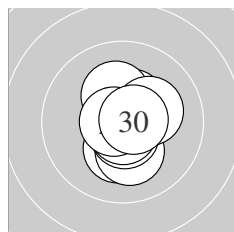

Serie 3:	10.3 *	10.6 *	10.2 *	10.6 *	10.4 *
	10.7 *	10.2 *	10.7 *	10.2 *	10.7 *
beste Teiler	51.1	(26.) 56.0 (28.)	72.7 (30.)		
Trefferlage	0.30 mm	rechts, 0.04 mm	tief		
Streuwert	0.96,	horizontal: 0.68, vertikal: 1.18			

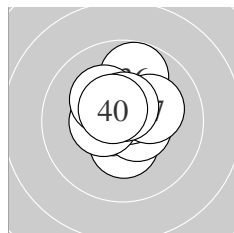

Serie 4:	10.4 *	10.5 *	10.6 *	10.5 *	10.5 *
	9.8 ↑	10.2 *	10.2 *	10.6 *	10.5 *
beste Teiler	83.1	(33.) 93.4 (39.)	101.0 (32.)		
Trefferlage	0.02 mm	links, 0.57 mm	hoch		
Streuwert	1.08,	horizontal: 1.02, vertikal: 1.14			

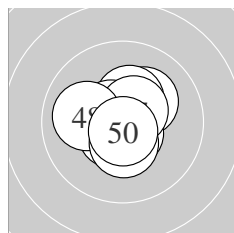

Serie 5:	10.5 *	10.6 *	10.2 *	10.4 *	10.6 *
	10.6 *	10.5 *	10.0 ←	10.4 *	10.7 *
beste Teiler	60.0	(50.) 81.9 (45.)	89.8 (46.)		
Trefferlage	0.16 mm	links, 0.11 mm	hoch		
Streuwert	0.99,	horizontal: 1.05, vertikal: 0.94			

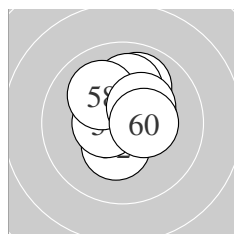

Serie 6:	10.6 *	10.3 *	9.9 ↑	10.4 *	10.4 *
	10.0 ↑	10.5 *	10.1 ↘	10.3 *	10.4 *
beste Teiler	100.2	(51.) 104.0 (57.)	130.8 (55.)		
Trefferlage	0.21 mm	rechts, 0.74 mm	hoch		
Streuwert	1.13,	horizontal: 1.07, vertikal: 1.19			

Meyton Elektronik

QF – Schütze hat sich fürs Finale qualifiziert

---

Unterschrift des Schützen

Meyton Elektronik

Ergebnis:	<b>625.7</b>	(597) <sup>QF</sup>						
Serien:	103.3	104.4	105.6	104.2	103.2	105.0		
Zähler:	57	3	0	0	0	0	0	0
Innenzehner:	52							
weiteste:	326 (4), 312 (46), 269 (47)							
beste Teiler	18.6 (26.) 41.1 (10.) 42.7 (57.)							
Trefferlage	0.13 mm links, 0.24 mm hoch							
Streuwert	1.02, horizontal: 0.94, vertikal: 1.10							

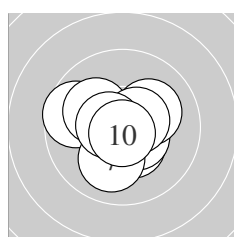
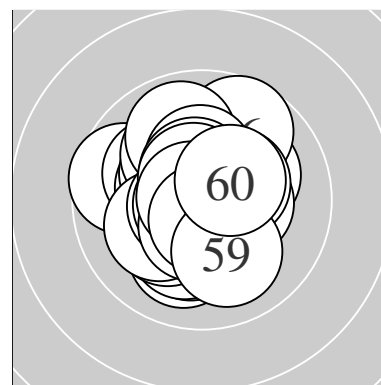

Serie 1:	10.6 *	10.4 *	10.5 *	9.6 ↖	10.1 ↗
	10.1 ↗	10.1 ↓	10.5 *	10.6 *	10.8 *
beste Teiler	41.1 (10.) 76.9 (1.) 92.9 (9.)				
Trefferlage	0.16 mm links, 0.06 mm tief				
Streuwert	1.28, horizontal: 1.49, vertikal: 1.04				

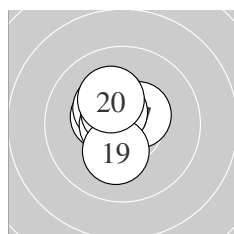

Serie 2:	10.7 *	10.4 *	10.3 *	10.7 *	10.4 *
	10.4 *	10.5 *	10.6 *	10.2 *	10.2 *
beste Teiler	68.1 (14.) 73.5 (11.) 99.0 (18.)				
Trefferlage	0.55 mm links, 0.49 mm hoch				
Streuwert	0.86, horizontal: 0.62, vertikal: 1.05				

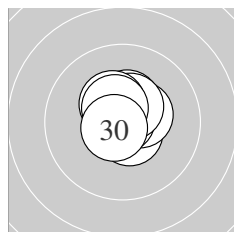

Serie 3:	10.6 *	10.7 *	10.4 *	10.5 *	10.4 *
	10.9 *	10.5 *	10.4 *	10.5 *	10.7 *
beste Teiler	18.6 (26.) 53.6 (22.) 69.0 (30.)				
Trefferlage	0.05 mm rechts, 0.55 mm hoch				
Streuwert	0.64, horizontal: 0.59, vertikal: 0.68				

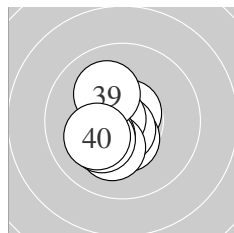

Serie 4:	10.7 *	10.6 *	10.5 *	10.7 *	10.7 *
	10.2 *	10.3 *	10.2 *	10.1 ↗	10.2 *
beste Teiler	57.0 (34.) 66.0 (31.) 68.4 (35.)				
Trefferlage	0.70 mm links, 0.48 mm tief				
Streuwert	0.90, horizontal: 0.72, vertikal: 1.06				

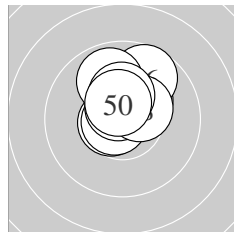

Serie 5:	10.3 *	10.6 *	10.7 *	10.6 *	10.2 *
	9.7 ↗	9.9 ↖	10.4 *	10.3 *	10.5 *
beste Teiler	57.8 (43.) 82.8 (42.) 83.5 (44.)				
Trefferlage	0.09 mm rechts, 1.22 mm hoch				
Streuwert	0.94, horizontal: 0.85, vertikal: 1.02				

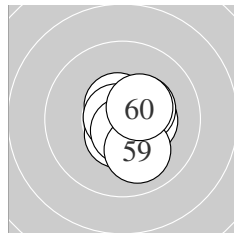

Serie 6:	10.4 *	10.7 *	10.6 *	10.4 *	10.5 *
	10.6 *	10.8 *	10.6 *	10.0 ↓	10.4 *
beste Teiler	42.7 (57.) 67.1 (52.) 78.4 (58.)				
Trefferlage	0.46 mm rechts, 0.28 mm tief				
Streuwert	0.84, horizontal: 0.73, vertikal: 0.94				

Meyton Elektronik

**ISSF AR Women – Wertung – Frauen**

StandNr: 119

**Grande, Martinez Paula #41**

**StartNr: 47**

1. Dezember 2019 11:34

ESP

---

QF – Schütze hat sich fürs Finale qualifiziert

---

Unterschrift des Schützen

Meyton Elektronik



Ergebnis: **586.2** (556)  
 Serien: 97.3 97.4 96.0 99.0 97.4 99.1  
 0.0  
 Zähler: 23 30 7 0 0 0 0 0 0 0  
 Innenzehner: 18  
 weiteste: 672 (24), 631 (30), 620 (6)  
 beste Teiler 13.6 (1.) 23.4 (39.) 62.0 (51.)  
 Trefferlage 0.86 mm links, 0.06 mm tief  
 Streuwert 2.32, horizontal: 2.74, vertikal: 1.79

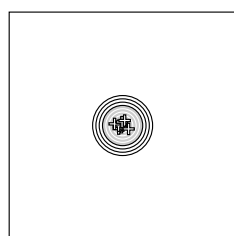
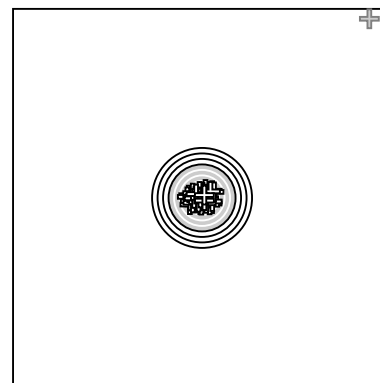

Serie 1:  
 10.9 \*                      10.4 \*                      10.3 \*                      9.4 ↙                      9.7 ←  
    8.5 ↖                      10.0 ↗                      9.9 ↗                      9.3 ↗                      8.9 ↘  
 beste Teiler 13.6 (1.) 149.4 (2.) 156.0 (3.)  
 Trefferlage 0.92 mm links, 0.38 mm hoch  
 Streuwert 2.52, horizontal: 2.85, vertikal: 2.13

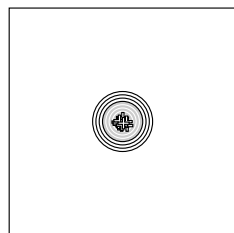

Serie 2:  
 9.9 ↗                      9.7 ↓                      9.1 ↘                      9.5 ↙                      9.4 ←  
    9.7 ←                      10.0 ←                      9.8 →                      9.9 ↓                      10.4 \*  
 beste Teiler 145.8 (20.) 245.7 (17.) 255.7 (11.)  
 Trefferlage 0.61 mm links, 1.07 mm tief  
 Streuwert 2.17, horizontal: 2.50, vertikal: 1.79

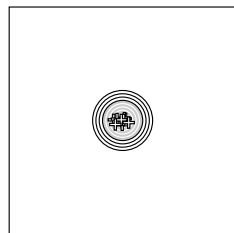

Serie 3:  
 9.9 ↗                      10.1 ↗                      10.4 \*                      8.3 ←                      9.6 ↓  
    9.2 ↖                      10.6 \*                      10.5 \*                      9.0 →                      8.4 ←  
 beste Teiler 89.0 (27.) 114.0 (28.) 138.5 (23.)  
 Trefferlage 0.91 mm links, 0.38 mm tief  
 Streuwert 2.84, horizontal: 3.59, vertikal: 1.81

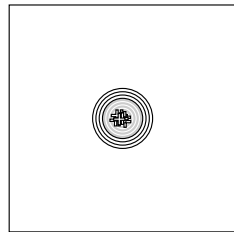

Serie 4:  
 9.7 ←                      8.7 ←                      10.0 ↗                      9.7 ↘                      10.2 \*  
    10.7 \*                      10.2 \*                      9.0 ↖                      10.9 \*                      9.9 ←  
 beste Teiler 23.4 (39.) 71.8 (36.) 186.1 (35.)  
 Trefferlage 1.47 mm links, 0.03 mm tief  
 Streuwert 1.97, horizontal: 2.35, vertikal: 1.51

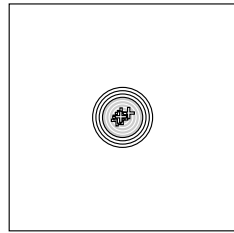

Serie 5:  
 8.7 ↗                      9.7 ↗                      9.7 ↖                      9.8 ←                      9.9 ←  
    10.5 \*                      9.1 ←                      9.9 ←                      9.7 ←                      10.4 \*  
 beste Teiler 119.5 (46.) 144.5 (50.) 262.3 (48.)  
 Trefferlage 1.63 mm links, 0.31 mm hoch  
 Streuwert 2.12, horizontal: 2.46, vertikal: 1.72

Meyton Elektronik

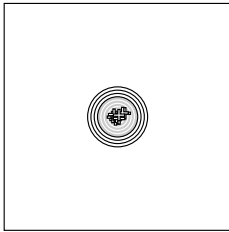

Serie 6:

10.7 *	10.4 *	8.5 ↗	10.0 ↘	9.5 ←
10.7 *	9.7 ↖	9.0 ↗	10.3 *	10.3 *

beste Teiler 62.0 (51.) 75.0 (56.) 139.0 (52.)  
 Trefferlage 0.39 mm rechts, 0.41 mm hoch  
 Streuwert 2.30, horizontal: 2.77, vertikal: 1.70

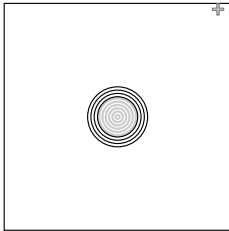

Serie 7:

0.0+ ↗  
AST.NSC

beste Teiler  
 Trefferlage 0.00 mm , 0.00 mm  
 Streuwert 0.00, horizontal: 0.00, vertikal: 0.00

AST – Treffer wurde nach Ende der Schießzeit abgegeben  
 NSC – Treffer wurde vermessen, geht aber nicht in die Wertung ein

Unterschrift des Schützen

Ergebnis:	<b>615.0</b>	(588) <sup>QF</sup>						
Serien:	102.7	102.8	102.2	104.2	102.7	100.4		
Zähler:	48	12	0	0	0	0	0	0
Innenzehner:	39							
weiteste:	368 (52), 356 (1), 337 (19)							
beste Teiler	12.6 (33.) 30.5 (13.) 43.0 (31.)							
Trefferlage	0.09 mm rechts, 0.03 mm tief							
Streuwert	1.41, horizontal: 1.55, vertikal: 1.25							

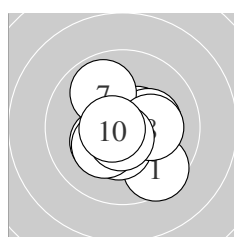
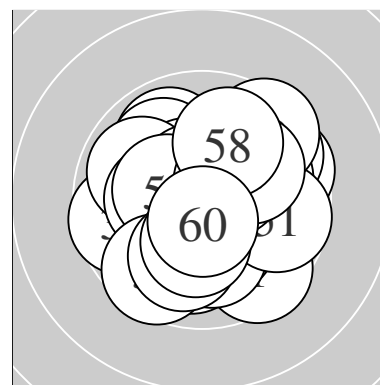

Serie 1:

9.5 ↘	10.3 *	10.5 *	10.4 *	10.2 *
10.3 *	9.9 ↘	10.2 *	10.7 *	10.7 *
beste Teiler	71.8 (9.) 72.0 (10.) 110.0 (3.)			
Trefferlage	0.19 mm rechts, 0.39 mm tief			
Streuwert	1.39, horizontal: 1.41, vertikal: 1.36			

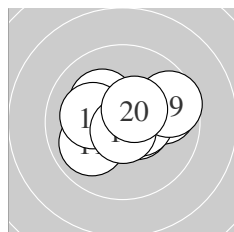

Serie 2:

10.0 ↙	10.6 *	10.8 *	10.2 *	10.1 ↖
9.8 →	10.5 *	10.7 *	9.6 →	10.5 *
beste Teiler	30.5 (13.) 55.1 (18.) 100.2 (12.)			
Trefferlage	0.33 mm rechts, 0.26 mm hoch			
Streuwert	1.41, horizontal: 1.81, vertikal: 0.85			

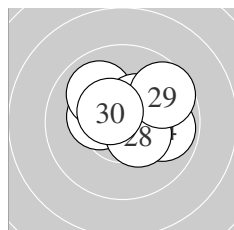

Serie 3:

10.4 *	10.4 *	10.2 *	9.9 →	10.3 *
10.0 ↘	10.4 *	10.4 *	9.7 ↗	10.5 *
beste Teiler	111.3 (30.) 127.0 (21.) 127.4 (22.)			
Trefferlage	0.25 mm rechts, 0.68 mm hoch			
Streuwert	1.35, horizontal: 1.68, vertikal: 0.91			

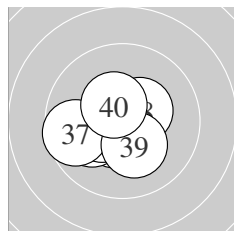

Serie 4:

10.8 *	10.8 *	10.9 *	10.5 *	10.1 ↖
10.4 *	9.6 ↖	10.4 *	10.2 *	10.5 *
beste Teiler	12.6 (33.) 43.0 (31.) 47.2 (32.)			
Trefferlage	0.61 mm links, 0.26 mm tief			
Streuwert	1.10, horizontal: 1.31, vertikal: 0.84			

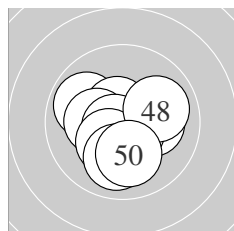

Serie 5:

10.2 *	9.9 ↖	10.6 *	10.3 *	10.6 *
10.7 *	10.3 *	10.0 →	10.0 ↓	10.1 ↓
beste Teiler	65.4 (46.) 85.7 (45.) 91.7 (43.)			
Trefferlage	0.11 mm links, 0.40 mm tief			
Streuwert	1.37, horizontal: 1.49, vertikal: 1.23			

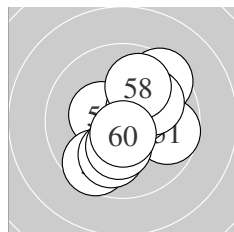

Serie 6:

9.7 →	9.5 ↗	10.4 *	9.6 ↙	10.0 ↓
10.4 *	10.0 ↗	9.9 ↑	10.3 *	10.6 *
beste Teiler	88.0 (60.) 131.7 (56.) 147.1 (53.)			
Trefferlage	0.53 mm rechts, 0.09 mm tief			
Streuwert	1.78, horizontal: 1.66, vertikal: 1.89			

Meyton Elektronik

**ISSF AR Women – Wertung – Frauen**

StandNr: 121

**Auer, Marie–Theres #46**

**StartNr: 49**

1. Dezember 2019 10:59

AUT

---

QF – Schütze hat sich fürs Finale qualifiziert

---

Unterschrift des Schützen

Meyton Elektronik

Ergebnis:	<b>610.6</b>	(585)
Serien:	100.5 99.1	105.3 102.4 101.8 101.5
Zähler:	45 15 0 0 0 0 0 0 0	
Innenzehner:	32	
weiteste:	485 (52), 387 (11), 377 (2)	
beste Teiler	28.1 (29.) 34.0 (21.) 54.4 (27.)	
Trefferlage	0.20 mm rechts, 0.15 mm tief	
Streuwert	1.53, horizontal: 1.52, vertikal: 1.54	

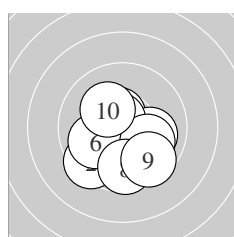
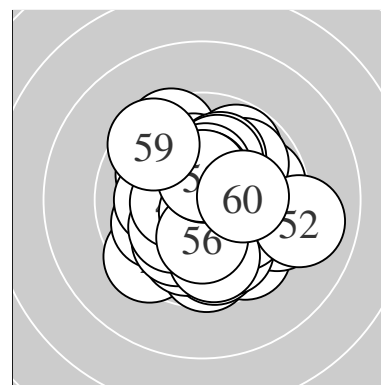

Serie 1:	10.5 *	9.4 ↙	10.0 →	10.7 *	10.4 *
	10.0 ↙	10.0 →	9.7 ↓	9.6 ↘	10.2 *
beste Teiler	69.6 (4.)	107.5 (1.)	131.2 (5.)		
Trefferlage	0.02 mm links, 0.98 mm tief				
Streuwert	1.67, horizontal: 1.72, vertikal: 1.62				

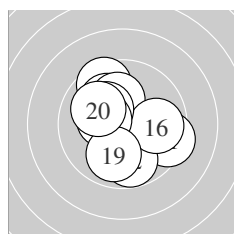

Serie 2:	9.4 →	9.8 ↓	9.5 ↖	10.0 ↖	10.1 ↑
	9.9 →	10.2 *	10.3 *	9.9 ↓	10.0 ↖
beste Teiler	154.0 (18.)	181.2 (17.)	202.4 (15.)		
Trefferlage	0.17 mm links, 0.31 mm hoch				
Streuwert	1.96, horizontal: 1.93, vertikal: 1.99				

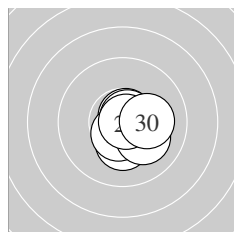

Serie 3:	10.8 *	10.3 *	10.7 *	10.7 *	10.4 *
	10.6 *	10.7 *	10.1 ↘	10.8 *	10.2 *
beste Teiler	28.1 (29.)	34.0 (21.)	54.4 (27.)		
Trefferlage	0.66 mm rechts, 0.28 mm tief				
Streuwert	0.75, horizontal: 0.77, vertikal: 0.73				

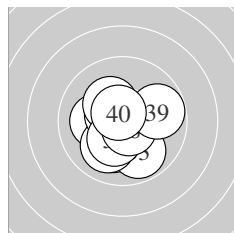

Serie 4:	10.1 ↓	10.1 ←	9.9 ↘	10.0 ↙	10.6 *
	10.3 *	10.3 *	10.6 *	9.8 →	10.7 *
beste Teiler	75.5 (40.)	77.8 (38.)	99.4 (35.)		
Trefferlage	0.22 mm links, 0.50 mm tief				
Streuwert	1.38, horizontal: 1.41, vertikal: 1.36				

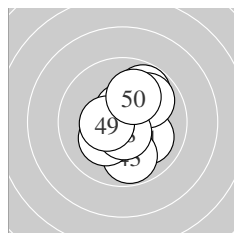

Serie 5:	10.0 ↘	10.4 *	9.8 ↓	9.8 ↗	10.6 *
	9.9 ↗	10.2 *	10.6 *	10.4 *	10.1 ↗
beste Teiler	83.8 (48.)	90.1 (45.)	128.6 (49.)		
Trefferlage	0.34 mm rechts, 0.01 mm tief				
Streuwert	1.52, horizontal: 1.30, vertikal: 1.71				

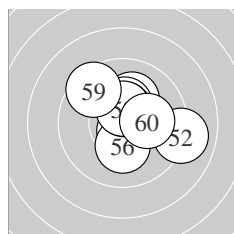

Serie 6:	10.1 ↗	9.0 →	10.5 *	10.3 *	10.7 *
	10.2 *	10.5 *	10.5 *	9.5 ↖	10.2 *
beste Teiler	63.5 (55.)	105.0 (53.)	113.7 (57.)		
Trefferlage	0.66 mm rechts, 0.52 mm hoch				
Streuwert	1.62, horizontal: 1.81, vertikal: 1.42				

**ISSF AR Women – Wertung – Frauen**

StandNr: 123

**Bindhammer, Edith** #212

**StartNr: 50**

1. Dezember 2019 11:30

T – Söller Sportschützen

---

\_\_\_\_\_  
Unterschrift des Schützen

Meyton Elektronik

Ergebnis:	<b>604.2</b>	(576)							
Serien:	100.4	100.8	98.7	103.5	100.8	100.0			
Zähler:	36	24	0	0	0	0	0	0	0
Innenzehner:	28								
weiteste:	483 (14), 396 (57), 394 (44)								
beste Teiler	32.5 (34.)	43.0 (15.)	45.0 (4.)						
Trefferlage	0.11 mm links, 0.59 mm hoch								
Streuwert	1.68, horizontal: 1.91, vertikal: 1.41								

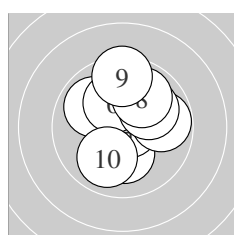
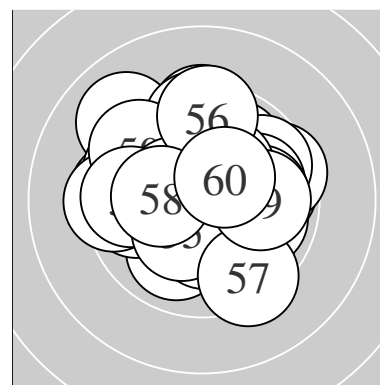

Serie 1:	10.2 *	10.2 *	9.9 ↘	10.8 *	9.8 →
	10.2 *	10.0 ↗	9.9 ↗	9.4 ↑	10.0 ↙
beste Teiler	45.0 (4.)	189.1 (1.)	194.5 (2.)		
Trefferlage	0.21 mm rechts, 0.86 mm hoch				
Streuwert	1.70, horizontal: 1.51, vertikal: 1.86				

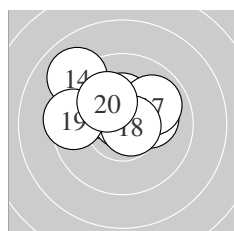

Serie 2:	10.1 ↘	10.3 *	10.2 *	9.0 ↘	10.8 *
	10.2 *	9.9 ↗	10.7 *	9.5 ←	10.1 ↘
beste Teiler	43.0 (15.)	62.1 (18.)	156.0 (12.)		
Trefferlage	0.36 mm links, 1.11 mm hoch				
Streuwert	1.66, horizontal: 2.12, vertikal: 1.01				

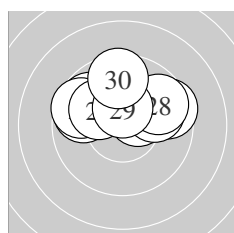

Serie 3:	9.5 →	9.8 ↘	9.7 ↘	9.6 ↘	10.1 ↘
	10.4 *	9.9 →	9.7 ↗	10.4 *	9.6 ↑
beste Teiler	129.0 (29.)	131.7 (26.)	211.3 (25.)		
Trefferlage	0.10 mm links, 1.42 mm hoch				
Streuwert	1.79, horizontal: 2.41, vertikal: 0.78				

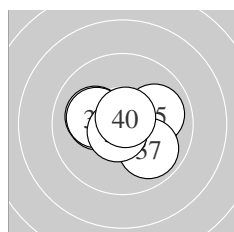

Serie 4:	10.2 *	10.7 *	10.2 *	10.8 *	10.0 →
	10.1 ←	9.9 ↘	10.2 *	10.7 *	10.7 *
beste Teiler	32.5 (34.)	53.1 (32.)	54.2 (40.)		
Trefferlage	0.03 mm rechts, 0.06 mm tief				
Streuwert	1.28, horizontal: 1.63, vertikal: 0.79				

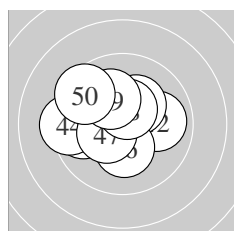

Serie 5:	10.6 *	9.9 →	9.8 ←	9.4 ←	10.3 *
	10.3 *	10.4 *	10.5 *	10.1 ↘	9.5 ↘
beste Teiler	76.9 (41.)	115.1 (48.)	134.8 (47.)		
Trefferlage	0.74 mm links, 0.33 mm hoch				
Streuwert	1.68, horizontal: 2.01, vertikal: 1.27				

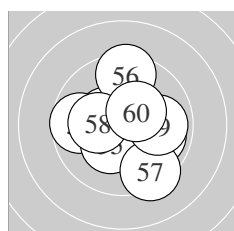

Serie 6:	10.4 *	9.9 →	9.7 ←	10.3 *	10.3 *
	9.5 ↑	9.4 ↘	10.2 *	9.9 →	10.4 *
beste Teiler	133.7 (51.)	142.8 (60.)	162.8 (54.)		
Trefferlage	0.25 mm rechts, 0.09 mm tief				
Streuwert	1.91, horizontal: 1.97, vertikal: 1.84				

**ISSF AR Women – Wertung – Frauen**

StandNr: 124

**Rangger, Patricia** #191

**StartNr: 51**

1. Dezember 2019 11:15

T – SG Mieming

---

\_\_\_\_\_  
Unterschrift des Schützen

Meyton Elektronik



Ergebnis:	<b>617.0</b>	(590) <sup>QF</sup>							
Serien:	103.0	102.7	101.2	103.7	103.1	103.3			
Zähler:	51	8	1	0	0	0	0	0	0
Innenzehner:	36								
weiteste:	648 (26), 351 (6), 314 (28)								
beste Teiler	26.0 (19.) 35.9 (23.) 43.2 (34.)								
Trefferlage	0.06 mm links, 0.44 mm hoch								
Streuwert	1.37, horizontal: 1.48, vertikal: 1.26								

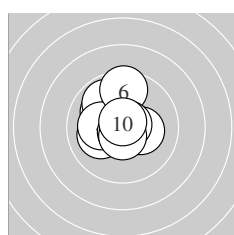
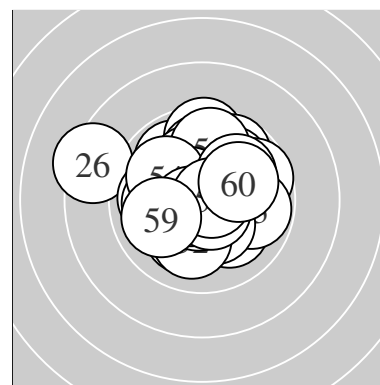

Serie 1:

10.1 ↘	9.9 ↘	10.1 ←	10.2 *	10.3 *
9.5 ↑	10.7 *	10.8 *	10.6 *	10.8 *
beste Teiler	47.5 (8.) 50.0 (10.) 55.4 (7.)			
Trefferlage	0.51 mm links, 0.57 mm hoch			
Streuwert	1.33, horizontal: 1.25, vertikal: 1.41			

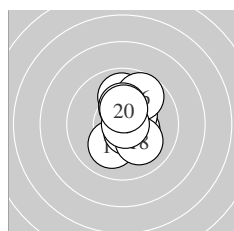

Serie 2:

10.4 *	10.4 *	9.9 ↑	10.1 ↙	10.6 *
9.7 ↗	10.3 *	10.1 ↘	10.8 *	10.4 *
beste Teiler	26.0 (19.) 79.8 (15.) 133.9 (12.)			
Trefferlage	0.51 mm rechts, 0.44 mm hoch			
Streuwert	1.28, horizontal: 0.83, vertikal: 1.61			

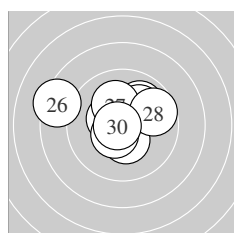

Serie 3:

10.0 ↗	10.4 *	10.8 *	10.4 *	10.1 ↗
8.4 ↖	10.1 ↘	9.7 ↗	10.5 *	10.8 *
beste Teiler	35.9 (23.) 50.4 (30.) 113.4 (29.)			
Trefferlage	0.28 mm links, 0.73 mm hoch			
Streuwert	1.92, horizontal: 2.43, vertikal: 1.22			

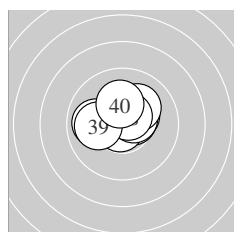

Serie 4:

10.4 *	10.6 *	10.6 *	10.8 *	9.9 ←
10.5 *	10.1 ↗	10.6 *	10.0 ←	10.2 *
beste Teiler	43.2 (34.) 90.8 (38.) 93.0 (32.)			
Trefferlage	0.10 mm links, 0.56 mm hoch			
Streuwert	1.11, horizontal: 1.41, vertikal: 0.70			

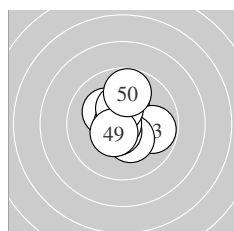

Serie 5:

10.1 ↑	10.6 *	9.8 →	10.2 *	10.3 *
10.6 *	10.8 *	10.4 *	10.5 *	9.8 ↑
beste Teiler	47.0 (47.) 80.9 (46.) 95.2 (42.)			
Trefferlage	0.10 mm rechts, 0.34 mm hoch			
Streuwert	1.32, horizontal: 1.16, vertikal: 1.47			

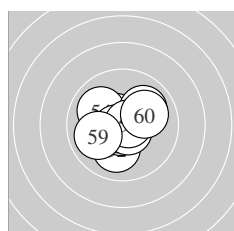

Serie 6:

10.5 *	10.0 ↓	10.7 *	10.0 ↘	10.7 *
10.0 ↗	10.7 *	10.7 *	10.0 ←	10.0 →
beste Teiler	55.1 (58.) 64.8 (53.) 69.9 (55.)			
Trefferlage	0.14 mm links, 0.00 mm			
Streuwert	1.31, horizontal: 1.45, vertikal: 1.16			

Meyton Elektronik

**ISSF AR Women – Wertung – Frauen**

StandNr: 125

**Vognarova, Gabriela #33**

**StartNr: 52**

1. Dezember 2019 11:31

CZE

---

QF – Schütze hat sich fürs Finale qualifiziert

---

Unterschrift des Schützen

Meyton Elektronik

Ergebnis: **191.8** (183)<sub>DNF</sub>  
 Serien: 96.0 95.8  
 Zähler: 6 11 3 0 0 0 0 0 0 0  
 Innenzehner: 5  
 weiteste: 647 (14), 594 (3), 543 (5)  
 beste Teiler 95.0 (12.) 109.7 (7.) 117.2 (17.)  
 Trefferlage 0.17 mm rechts, 0.42 mm hoch  
 Streuwert 2.73, horizontal: 3.33, vertikal: 1.95

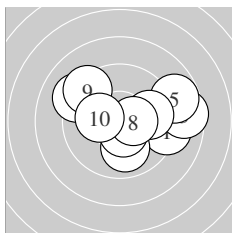
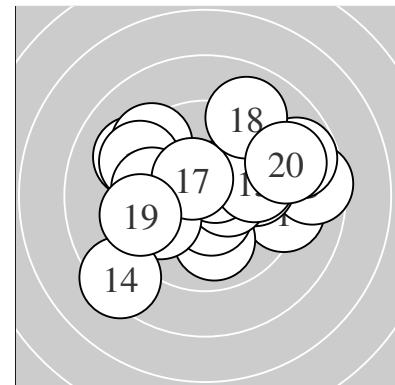

Serie 1:  
 9.2 → 9.2 ↖ 8.6 → 10.0 ↓ 8.8 →  
 9.8 → 10.5 \* 10.4 \* 9.3 ↖ 10.2 \*  
 beste Teiler 109.7 (7.) 126.0 (8.) 186.7 (10.)  
 Trefferlage 1.14 mm rechts, 0.43 mm hoch  
 Streuwert 2.65, horizontal: 3.38, vertikal: 1.62

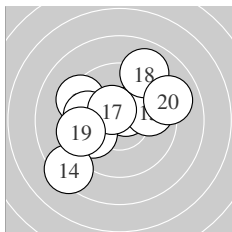

Serie 2:  
 9.3 ↖ 10.6 \* 9.9 ↙ 8.4 ↙ 9.8 →  
 9.8 ← 10.5 \* 9.0 ↗ 9.5 ← 9.0 →  
 beste Teiler 95.0 (12.) 117.2 (17.) 274.5 (13.)  
 Trefferlage 0.78 mm links, 0.41 mm hoch  
 Streuwert 2.77, horizontal: 3.14, vertikal: 2.33

DNF – Schütze hat den Wettkampf nicht beendet

Unterschrift des Schützen