

Ergebnis:	388	(407.0)
Serien:	95 94 100 99	
Zähler:	28 12 0 0 0 0 0 0 0 0	
Innenzehner:	23	
weiteste:	408 (2), 397 (15), 354 (19)	
beste Teiler	17.0 (12.) 46.0 (27.) 47.6 (3.)	
Trefferlage	0.55 mm links, 0.15 mm hoch	
Streuwert	1.50, horizontal: 1.45, vertikal: 1.55	

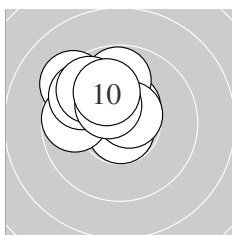

Serie 1:

10.5 *	9.3 ↘	10.8 *	9.7 ←	9.7 ↘
9.8 ↑	10.6 *	9.7 ↘	10.4 *	10.1 ↗
beste Teiler	47.6 (3.)	85.7 (7.)	118.9 (1.)	
Trefferlage	1.11 mm links, 1.43 mm hoch			
Streuwert	1.27, horizontal: 1.44, vertikal: 1.08			

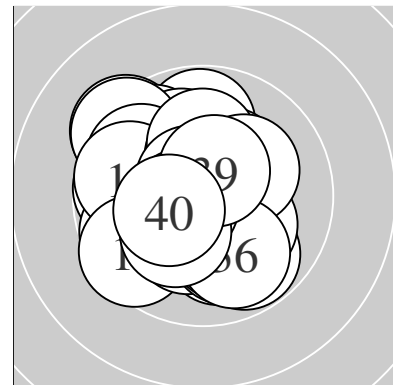
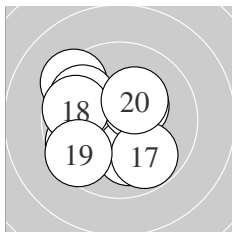

Serie 2:

9.7 ↙	10.9 *	10.1 ↓	10.4 *	9.4 ↘
9.8 ↘	9.8 ↘	9.7 ←	9.5 ↙	10.3 *
beste Teiler	17.0 (12.)	143.0 (14.)	167.0 (20.)	
Trefferlage	0.98 mm links, 0.11 mm tief			
Streuwert	1.89, horizontal: 1.98, vertikal: 1.79			

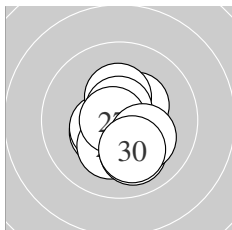

Serie 3:

10.4 *	10.4 *	10.5 *	10.2 *	10.3 *
10.7 *	10.8 *	10.0 ↓	10.2 *	10.1 ↓
beste Teiler	46.0 (27.)	70.2 (26.)	122.6 (23.)	
Trefferlage	0.08 mm rechts, 0.49 mm tief			
Streuwert	1.13, horizontal: 0.95, vertikal: 1.29			

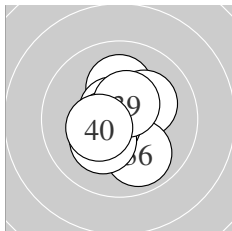

Serie 4:

10.1 ↑	10.6 *	10.4 *	10.3 *	10.2 *
9.9 ↓	10.6 *	10.2 *	10.5 *	10.4 *
beste Teiler	76.0 (32.)	86.9 (37.)	110.5 (39.)	
Trefferlage	0.22 mm links, 0.21 mm tief			
Streuwert	1.21, horizontal: 1.04, vertikal: 1.36			

Unterschrift des Schützen

Ergebnis:	392	(411.9)
Serien:	96 98 100 98	
Zähler:	32 8 0 0 0 0 0 0 0 0	
Innenzehner:	29	
weiteste:	386 (6), 298 (1), 287 (33)	
beste Teiler	15.2 (16.) 29.0 (24.) 47.3 (18.)	
Trefferlage	0.21 mm rechts, 0.09 mm hoch	
Streuwert	1.31, horizontal: 1.45, vertikal: 1.14	

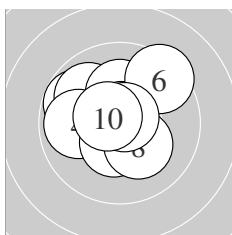
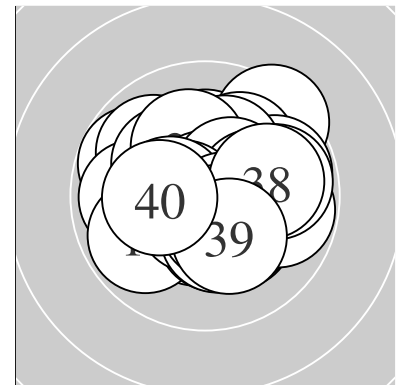

Serie 1:

9.8 ↖	9.9 ↖	10.2 *	9.9 ←	10.8 *
9.4 ↗	10.4 *	10.2 *	10.8 *	10.6 *
beste Teiler	47.8 (5.) 49.8 (9.) 89.5 (10.)			
Trefferlage	0.42 mm links, 0.63 mm hoch			
Streuwert	1.53, horizontal: 1.69, vertikal: 1.35			

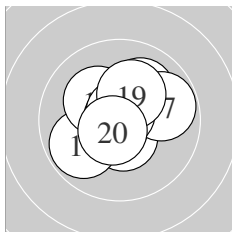

Serie 2:

10.5 *	10.1 ↗	10.5 *	9.8 ↙	10.2 *
10.9 *	9.8 →	10.8 *	10.2 *	10.6 *
beste Teiler	15.2 (16.) 47.3 (18.) 81.2 (20.)			
Trefferlage	0.01 mm rechts, 0.39 mm hoch			
Streuwert	1.29, horizontal: 1.41, vertikal: 1.15			

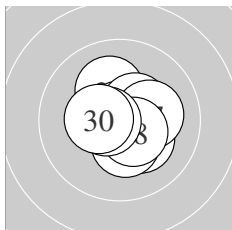

Serie 3:

10.1 ↖	10.2 *	10.5 *	10.8 *	10.4 *
10.3 *	10.2 *	10.5 *	10.6 *	10.4 *
beste Teiler	29.0 (24.) 85.3 (29.) 107.4 (23.)			
Trefferlage	0.31 mm rechts, 0.10 mm tief			
Streuwert	1.03, horizontal: 1.03, vertikal: 1.03			

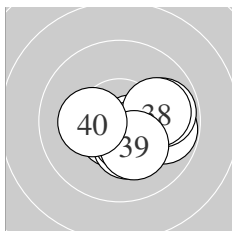

Serie 4:

10.6 *	10.5 *	9.8 →	9.8 →	10.3 *
10.6 *	10.5 *	10.0 →	10.2 *	10.2 *
beste Teiler	86.4 (31.) 95.6 (36.) 114.5 (37.)			
Trefferlage	0.94 mm rechts, 0.54 mm tief			
Streuwert	1.14, horizontal: 1.43, vertikal: 0.74			

Unterschrift des Schützen

Ergebnis:	391	(406.4)
Serien:	97	98 99 97
Zähler:	32	7 1 0 0 0 0 0 0 0
Innenzehner:	21	
weiteste:	555 (8),	423 (11), 422 (19)
beste Teiler	23.0 (3.)	31.3 (9.) 70.0 (39.)
Trefferlage	0.13 mm rechts, 0.07 mm tief	
Streuwert	1.64, horizontal: 1.83, vertikal: 1.42	

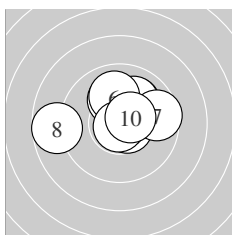
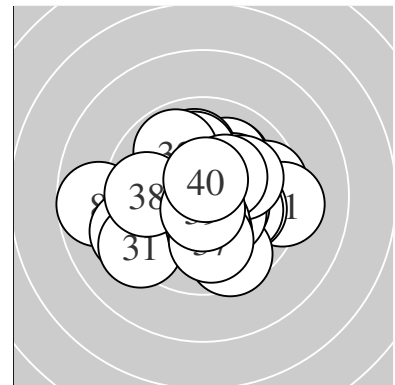

Serie 1:	10.0 ↗	10.6 *	10.9 *	10.1 ↑	10.0 ↗
	10.0 ↑	9.6 →	8.7 ←	10.8 *	10.5 *
beste Teiler	23.0 (3.) 31.3 (9.) 79.4 (2.)				
Trefferlage	0.10 mm rechts, 0.82 mm hoch				
Streuwert	1.80, horizontal: 2.28, vertikal: 1.12				

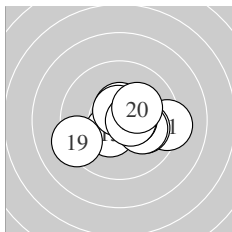

Serie 2:	9.3 →	10.5 *	10.4 *	10.6 *	10.0 →
	10.1 →	10.5 *	10.6 *	9.3 ←	10.2 *
beste Teiler	84.1 (14.) 99.1 (18.) 109.0 (12.)				
Trefferlage	0.72 mm rechts, 0.17 mm tief				
Streuwert	1.66, horizontal: 2.13, vertikal: 0.97				

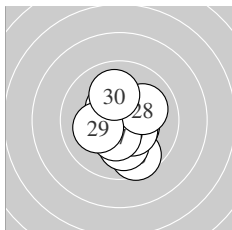

Serie 3:	10.5 *	10.4 *	9.6 ↓	10.1 ↓	10.4 *
	10.4 *	10.4 *	10.1 →	10.1 ←	10.0 ↑
beste Teiler	104.3 (21.) 130.4 (22.) 139.7 (25.)				
Trefferlage	0.19 mm rechts, 0.52 mm tief				
Streuwert	1.43, horizontal: 1.25, vertikal: 1.58				

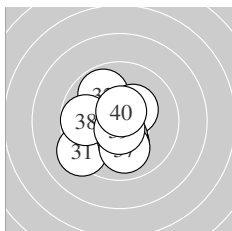

Serie 4:	9.3 ↙	9.8 ↖	10.6 *	10.2 *	10.3 *
	10.4 *	10.0 ↓	9.8 ←	10.7 *	10.6 *
beste Teiler	70.0 (39.) 82.6 (33.) 87.1 (40.)				
Trefferlage	0.47 mm links, 0.42 mm tief				
Streuwert	1.61, horizontal: 1.56, vertikal: 1.65				

Unterschrift des Schützen

Meyton Elektronik

Ergebnis:	387	(405.6)
Serien:	95	100 96 96
Zähler:	27	13 0 0 0 0 0 0 0 0
Innenzehner:	19	
weiteste:	438	(21), 329 (9), 316 (39)
beste Teiler	47.6	(33.) 65.0 (16.) 71.0 (40.)
Trefferlage	0.33 mm	links, 0.39 mm hoch
Streuwert	1.54,	horizontal: 1.63, vertikal: 1.44

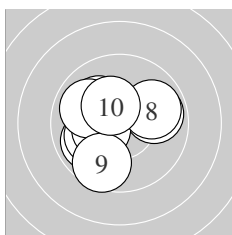
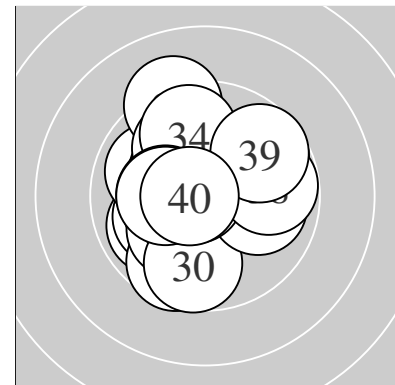

Serie 1:	9.9 →	10.1 ↖	10.3 *	9.9 ↙	10.1 ↙
	10.4 *	9.9 ↖	9.9 →	9.6 ↓	10.4 *
beste Teiler	148.6	(6.) 149.3 (10.)	157.3 (3.)		
Trefferlage	0.80 mm	links, 0.03 mm	tief		
Streuwert	1.64,	horizontal: 1.83, vertikal: 1.43			

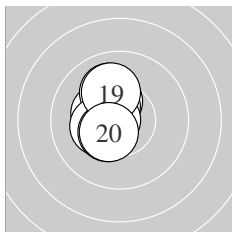

Serie 2:	10.3 *	10.5 *	10.4 *	10.3 *	10.1 ↖
	10.7 *	10.3 *	10.4 *	10.1 ↖	10.5 *
beste Teiler	65.0	(16.) 122.4 (20.)	124.5 (12.)		
Trefferlage	0.93 mm	links, 0.54 mm	hoch		
Streuwert	0.84,	horizontal: 0.37, vertikal: 1.13			

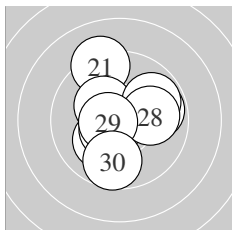

Serie 3:	9.2 ↖	10.1 ↙	10.6 *	10.5 *	10.3 *
	9.8 →	9.8 →	10.0 →	10.6 *	9.7 ↓
beste Teiler	89.1	(23.) 89.2 (29.)	112.0 (24.)		
Trefferlage	0.05 mm	rechts, 0.16 mm	hoch		
Streuwert	1.82,	horizontal: 1.71, vertikal: 1.93			

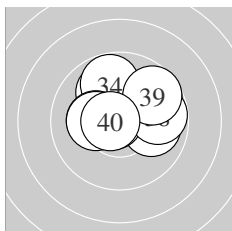

Serie 4:	10.0 ↖	10.0 →	10.8 *	9.8 ↖	9.7 ↗
	10.2 *	10.2 *	9.8 →	9.7 ↗	10.7 *
beste Teiler	47.6	(33.) 71.0 (40.)	181.0 (36.)		
Trefferlage	0.36 mm	rechts, 0.88 mm	hoch		
Streuwert	1.61,	horizontal: 1.96, vertikal: 1.16			

Unterschrift des Schützen

Ergebnis: **375** (392.4)
 Serien: 92 92 97 94
 Zähler: 19 18 2 1 0 0 0 0 0 0
 Innenzehner: 16
 weiteste: 784 (17), 600 (32), 582 (12)
 beste Teiler 58.0 (11.) 72.1 (2.) 74.4 (28.)
 Trefferlage 0.24 mm rechts, 1.04 mm tief
 Streuwert 2.24, horizontal: 2.39, vertikal: 2.08

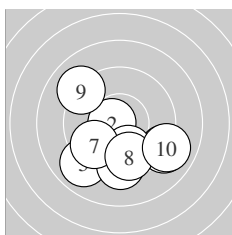
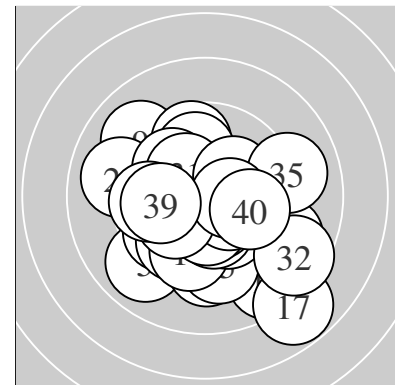

Serie 1:
 10.2 * 10.7 * 9.0 ↘ 9.9 ↓ 9.0 ↙
 9.4 ↓ 9.7 ↙ 9.7 ↓ 9.1 ↖ 9.0 ↘
 beste Teiler 72.1 (2.) 198.8 (1.) 257.7 (4.)
 Trefferlage 0.05 mm links, 1.85 mm tief
 Streuwert 2.43, horizontal: 2.76, vertikal: 2.06

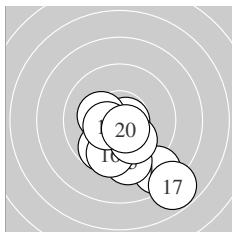

Serie 2:
 10.7 * 8.6 ↘ 10.2 * 9.8 ↙ 9.4 ↓
 9.7 ↓ 7.8 ↘ 10.1 ↘ 10.4 * 10.6 *
 beste Teiler 58.0 (11.) 97.9 (20.) 129.3 (19.)
 Trefferlage 0.61 mm rechts, 2.30 mm tief
 Streuwert 2.16, horizontal: 2.19, vertikal: 2.13

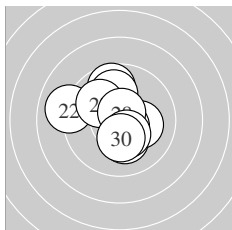

Serie 3:
 9.7 ↑ 9.0 ← 10.2 * 10.2 * 10.6 *
 9.9 ↑ 10.0 ↖ 10.7 * 10.4 * 10.3 *
 beste Teiler 74.4 (28.) 78.5 (25.) 146.6 (29.)
 Trefferlage 0.40 mm links, 0.30 mm hoch
 Streuwert 1.77, horizontal: 1.81, vertikal: 1.73

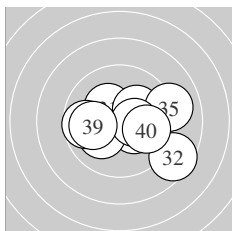

Serie 4:
 10.3 * 8.6 ↘ 10.3 * 10.2 * 9.0 →
 10.1 ↙ 10.4 * 9.7 ← 9.9 ← 9.9 →
 beste Teiler 140.6 (37.) 157.7 (33.) 166.7 (31.)
 Trefferlage 0.80 mm rechts, 0.33 mm tief
 Streuwert 2.24, horizontal: 2.84, vertikal: 1.40

Unterschrift des Schützen

Ergebnis:	367	(385.1)
Serien:	89 95 92 91	
Zähler:	16 15 9 0 0 0 0 0 0	
Innenzehner:	14	
weiteste:	666 (6), 644 (33), 633 (31)	
beste Teiler	43.4 (20.) 61.3 (11.) 85.7 (21.)	
Trefferlage	0.18 mm rechts, 0.14 mm hoch	
Streuwert	2.72, horizontal: 2.83, vertikal: 2.61	

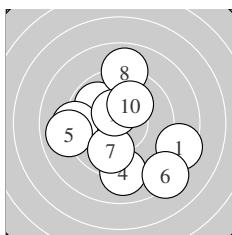
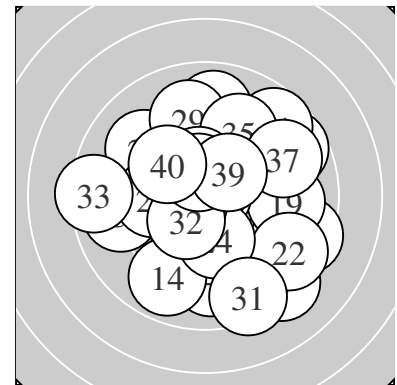

Serie 1:	8.5 ↘	9.9 ↖	9.2 ←	9.1 ↓	9.0 ←
	8.3 ↘	9.9 ↓	8.9 ↑	10.5 *	10.1 ↗
beste Teiler	112.7 (9.)	208.6 (10.)	270.3 (7.)		
Trefferlage	0.06 mm links, 0.61 mm tief				
Streuwert	3.25, horizontal: 3.36, vertikal: 3.14				

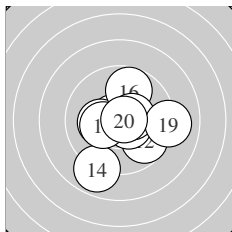

Serie 2:	10.7 *	9.7 ↘	10.2 *	8.9 ↓	10.5 *
	9.8 ↑	10.5 *	10.3 *	9.1 →	10.8 *
beste Teiler	43.4 (20.)	61.3 (11.)	103.2 (15.)		
Trefferlage	0.42 mm rechts, 0.46 mm tief				
Streuwert	2.01, horizontal: 2.11, vertikal: 1.90				

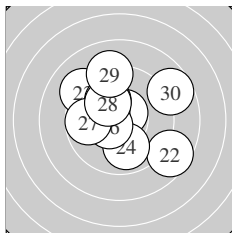

Serie 3:	10.6 *	8.6 ↘	9.2 ↖	9.9 ↓	10.1 ↖
	10.5 *	9.7 ←	10.2 *	9.1 ↑	8.7 ↗
beste Teiler	85.7 (21.)	110.9 (26.)	200.8 (28.)		
Trefferlage	0.01 mm rechts, 0.77 mm hoch				
Streuwert	2.66, horizontal: 2.87, vertikal: 2.42				

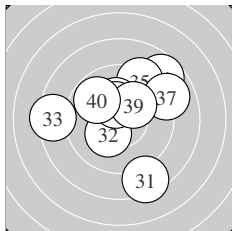

Serie 4:	8.4 ↓	10.2 *	8.4 ←	8.7 ↗	9.3 ↗
	10.2 *	9.0 ↗	10.4 *	10.2 *	9.8 ↖
beste Teiler	140.9 (38.)	178.6 (36.)	178.8 (32.)		
Trefferlage	0.38 mm rechts, 0.90 mm hoch				
Streuwert	3.04, horizontal: 3.24, vertikal: 2.83				

Unterschrift des Schützen

Ergebnis:	385	(403.0)
Serien:	96 98 96 95	
Zähler:	26 13 1 0 0 0 0 0 0 0	
Innenzehner:	20	
weiteste:	509 (14), 436 (1), 398 (3)	
beste Teiler	64.8 (29.) 69.4 (2.) 79.5 (25.)	
Trefferlage	0.50 mm rechts, 0.80 mm hoch	
Streuwert	1.60, horizontal: 1.68, vertikal: 1.50	

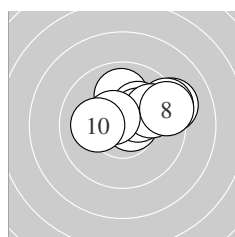
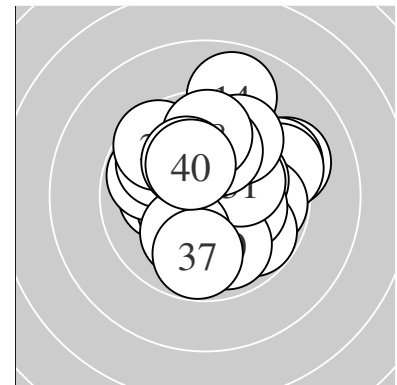

Serie 1:	9.2 ↗	10.7 *	9.4 ↗	10.0 ↑	10.2 *
	10.3 *	9.9 ↗	9.4 ↗	10.5 *	10.1 ←
beste Teiler	69.4 (2.)	101.0 (9.)	152.2 (6.)		
Trefferlage	1.39 mm rechts, 1.13 mm hoch				
Streuwert	1.54, horizontal: 2.04, vertikal: 0.76				

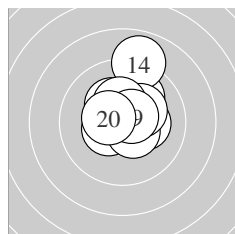

Serie 2:	10.2 *	10.0 ↗	10.4 *	8.9 ↑	10.5 *
	10.3 *	10.3 *	10.3 *	10.6 *	10.5 *
beste Teiler	88.2 (19.)	114.8 (15.)	121.4 (20.)		
Trefferlage	0.39 mm rechts, 1.03 mm hoch				
Streuwert	1.42, horizontal: 1.15, vertikal: 1.64				

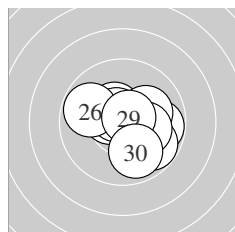

Serie 3:	10.5 *	10.4 *	9.8 →	10.1 ↗	10.6 *
	9.8 ↖	9.8 ↘	10.2 *	10.7 *	9.9 ↘
beste Teiler	64.8 (29.)	79.5 (25.)	111.4 (21.)		
Trefferlage	0.56 mm rechts, 0.08 mm tief				
Streuwert	1.50, horizontal: 1.76, vertikal: 1.19				

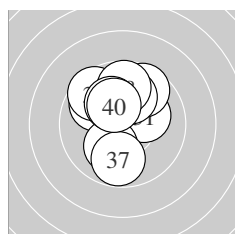

Serie 4:	10.2 *	9.7 ↗	9.9 ↖	10.0 ↑	9.6 ↖
	10.1 ↘	9.8 ↓	9.7 ↑	10.2 *	10.3 *
beste Teiler	171.8 (40.)	190.1 (31.)	194.6 (39.)		
Trefferlage	0.33 mm links, 1.15 mm hoch				
Streuwert	1.72, horizontal: 1.41, vertikal: 1.98				

Unterschrift des Schützen

Meyton Elektronik

Ergebnis: **383** (400.7)
 Serien: 95 97 96 95
 Zähler: 24 15 1 0 0 0 0 0 0
 Innenzehner: 18
 weiteste: 676 (32), 436 (14), 413 (28)
 beste Teiler 31.1 (34.) 58.1 (1.) 66.0 (19.)
 Trefferlage 0.10 mm rechts, 0.03 mm hoch
 Streuwert 1.86, horizontal: 1.68, vertikal: 2.04

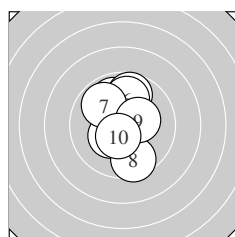
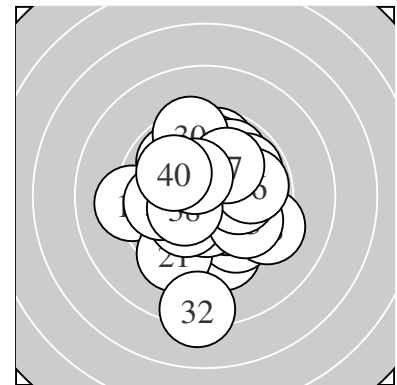

Serie 1:
 10.7 * 10.3 * 10.0 ↕ 9.9 ↗ 9.7 ↗
 9.9 ↗ 9.9 ↘ 9.5 ↓ 10.3 * 10.5 *
 beste Teiler 58.1 (1.) 116.6 (10.) 158.1 (2.)
 Trefferlage 0.18 mm links, 0.70 mm hoch
 Streuwert 1.68, horizontal: 1.07, vertikal: 2.12

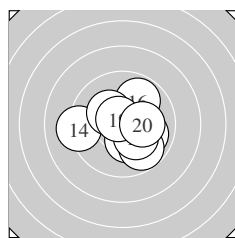

Serie 2:
 10.3 * 10.0 ↘ 9.8 ↘ 9.2 ← 10.5 *
 9.9 ↗ 10.3 * 10.2 * 10.7 * 10.2 *
 beste Teiler 66.0 (19.) 105.6 (15.) 165.8 (11.)
 Trefferlage 0.38 mm rechts, 0.17 mm tief
 Streuwert 1.74, horizontal: 2.01, vertikal: 1.42

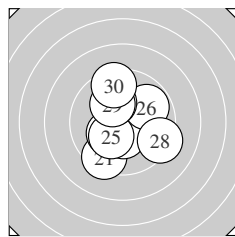

Serie 3:
 9.4 ↘ 10.3 * 10.3 * 10.4 * 10.2 *
 9.8 ↗ 10.1 ↘ 9.3 ↘ 10.1 ↘ 9.4 ↗
 beste Teiler 139.2 (24.) 154.2 (23.) 174.9 (22.)
 Trefferlage 0.06 mm rechts, 0.01 mm hoch
 Streuwert 2.02, horizontal: 1.84, vertikal: 2.18

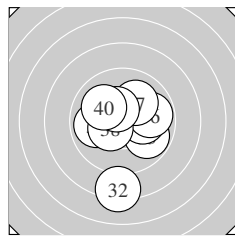

Serie 4:
 9.9 ← 8.2 ↓ 9.8 ↘ 10.8 * 10.2 *
 9.8 → 10.1 ↗ 10.4 * 10.4 * 10.0 ↘
 beste Teiler 31.1 (34.) 131.0 (39.) 140.2 (38.)
 Trefferlage 0.16 mm rechts, 0.40 mm tief
 Streuwert 2.17, horizontal: 1.85, vertikal: 2.44

Unterschrift des Schützen

Meyton Elektronik

Ergebnis:	388	(406.2)
Serien:	96 96 98 98	
Zähler:	29 10 1 0 0 0 0 0 0 0	
Innenzehner:	23	
weiteste:	507 (8), 470 (26), 388 (9)	
beste Teiler	8.5 (39.) 29.6 (28.) 43.4 (34.)	
Trefferlage	0.05 mm links, 0.76 mm hoch	
Streuwert	1.54, horizontal: 1.47, vertikal: 1.61	

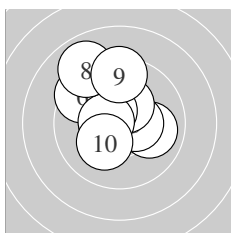
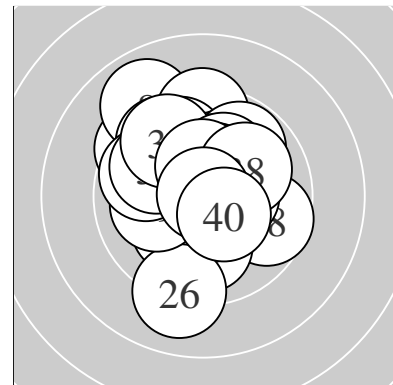

Serie 1:	10.5 *	10.0 →	10.4 *	10.3 *	10.4 *
	9.5 ↖	10.5 *	8.9 ↖	9.4 ↑	10.2 *
beste Teiler	102.2 (1.)	107.6 (7.)	127.0 (3.)		
Trefferlage	0.56 mm links, 1.09 mm hoch				
Streuwert	1.78, horizontal: 1.65, vertikal: 1.90				

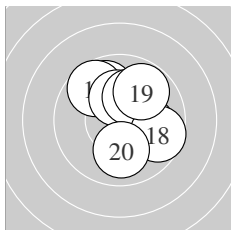

Serie 2:	10.3 *	9.9 ↖	10.4 *	10.1 →	9.7 ↖
	10.2 *	10.1 ↑	9.7 →	9.8 ↗	10.0 ↓
beste Teiler	135.8 (13.)	154.0 (11.)	177.2 (16.)		
Trefferlage	0.61 mm rechts, 0.92 mm hoch				
Streuwert	1.60, horizontal: 1.50, vertikal: 1.68				

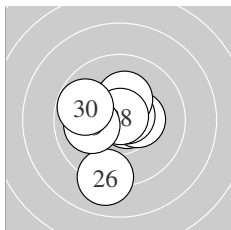

Serie 3:	10.7 *	10.4 *	10.4 *	10.5 *	10.7 *
	9.1 ↓	10.3 *	10.8 *	10.1 ←	9.8 ↖
beste Teiler	29.6 (28.)	59.0 (21.)	67.7 (25.)		
Trefferlage	0.43 mm links, 0.01 mm hoch				
Streuwert	1.54, horizontal: 1.33, vertikal: 1.72				

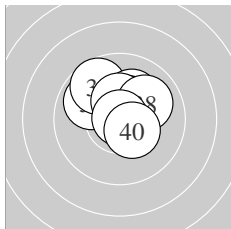

Serie 4:	10.4 *	9.9 ↖	9.7 ↖	10.8 *	10.2 *
	10.4 *	10.4 *	10.0 ↗	10.9 *	10.4 *
beste Teiler	8.5 (39.)	43.4 (34.)	133.8 (40.)		
Trefferlage	0.16 mm rechts, 1.01 mm hoch				
Streuwert	1.15, horizontal: 1.27, vertikal: 1.00				

Unterschrift des Schützen

Ergebnis:	377	(396.8)
Serien:	91 95 95 96	
Zähler:	19 19 2 0 0 0 0 0 0 0	
Innenzehner:	11	
weiteste:	570 (6), 555 (9), 460 (2)	
beste Teiler	4.4 (14.) 69.2 (15.) 78.8 (25.)	
Trefferlage	0.29 mm links, 0.14 mm hoch	
Streuwert	2.04, horizontal: 1.96, vertikal: 2.12	

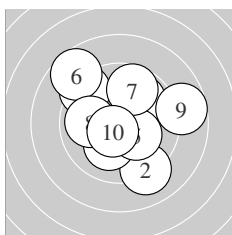
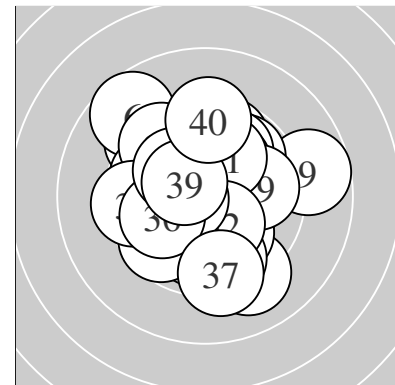

Serie 1:	9.3 ↘	9.1 ↘	10.1 ↙	9.9 ↗	10.3 *
	8.7 ↘	9.7 ↑	9.9 ←	8.7 →	10.6 *
beste Teiler	92.9 (10.)	175.5 (5.)	208.8 (3.)		
Trefferlage	0.11 mm rechts, 0.58 mm hoch				
Streuwert	2.69, horizontal: 2.83, vertikal: 2.54				

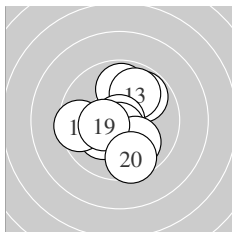

Serie 2:	9.9 ↑	9.8 ↗	9.9 ↗	10.9 *	10.7 *
	10.2 *	10.0 ↘	9.5 ←	10.4 *	9.6 ↓
beste Teiler	4.4 (14.)	69.2 (15.)	143.5 (19.)		
Trefferlage	0.05 mm links, 0.09 mm tief				
Streuwert	1.80, horizontal: 1.66, vertikal: 1.93				

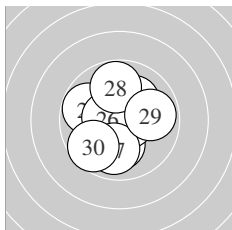

Serie 3:	10.1 ↗	9.8 ↖	10.1 ↓	10.1 ↙	10.6 *
	10.5 *	9.9 ↓	9.8 ↑	9.9 →	9.7 ↙
beste Teiler	78.8 (25.)	108.4 (26.)	205.8 (21.)		
Trefferlage	0.33 mm links, 0.28 mm tief				
Streuwert	1.75, horizontal: 1.63, vertikal: 1.86				

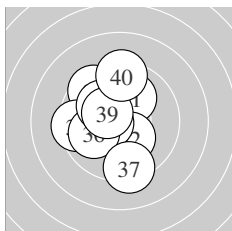

Serie 4:	10.1 ↗	10.3 *	10.5 *	9.6 ↘	9.4 ←
	10.0 ←	9.3 ↓	10.1 ↘	10.4 *	9.4 ↑
beste Teiler	102.4 (33.)	129.7 (39.)	170.1 (32.)		
Trefferlage	0.90 mm links, 0.35 mm hoch				
Streuwert	1.98, horizontal: 1.60, vertikal: 2.30				

Unterschrift des Schützen

Ergebnis:	376	(393.5)
Serien:	94 95 93 94	
Zähler:	18 20 2 0 0 0 0 0 0 0	
Innenzehner:	9	
weiteste:	545 (3), 530 (26), 437 (33)	
beste Teiler	42.2 (6.) 95.8 (39.) 105.0 (23.)	
Trefferlage	1.07 mm links, 0.47 mm hoch	
Streuwert	2.00, horizontal: 2.27, vertikal: 1.69	

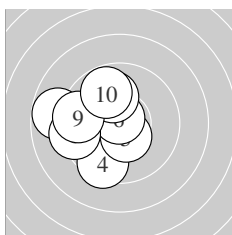
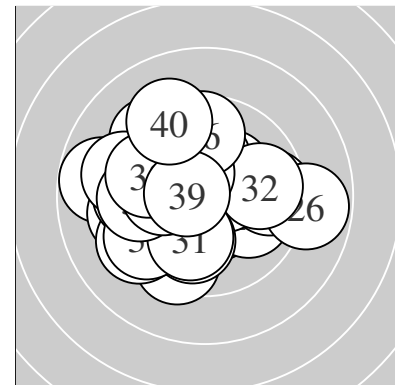

Serie 1:

10.1 ↖	10.4 *	8.8 ←	9.5 ↓	10.4 *
10.8 *	10.0 ↑	9.3 ←	9.5 ←	9.8 ↑
beste Teiler	42.2 (6.) 127.9 (5.) 150.2 (2.)			
Trefferlage	1.81 mm links, 0.05 mm hoch			
Streuwert	1.87, horizontal: 1.92, vertikal: 1.82			

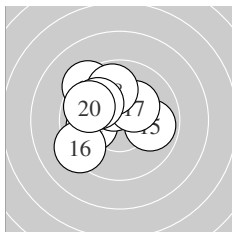

Serie 2:

10.1 ↖	10.0 ←	9.3 ↖	10.4 *	9.9 →
9.3 ↖	10.3 *	9.9 ↑	10.0 ↖	9.8 ↖
beste Teiler	138.7 (14.) 173.9 (17.) 203.0 (11.)			
Trefferlage	1.13 mm links, 0.93 mm hoch			
Streuwert	1.76, horizontal: 1.92, vertikal: 1.59			

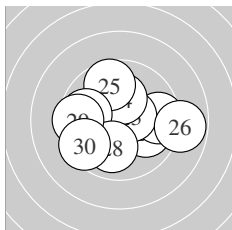

Serie 3:

10.0 ↘	9.6 →	10.5 *	10.2 *	9.7 ↑
8.8 →	9.8 ←	10.0 ↓	9.5 ←	9.5 ↖
beste Teiler	105.0 (23.) 187.6 (24.) 242.1 (28.)			
Trefferlage	0.09 mm rechts, 0.00 mm			
Streuwert	2.38, horizontal: 2.94, vertikal: 1.65			

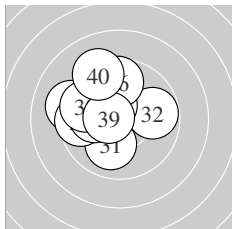

Serie 4:

10.0 ↓	9.8 →	9.2 ←	9.6 ←	10.4 *
9.7 ↑	10.1 ←	9.7 ←	10.6 *	9.2 ↑
beste Teiler	95.8 (39.) 139.4 (35.) 217.8 (37.)			
Trefferlage	1.43 mm links, 0.90 mm hoch			
Streuwert	1.86, horizontal: 2.01, vertikal: 1.71			

Unterschrift des Schützen

Meyton Elektronik

Ergebnis: **365** (382.2)
 Serien: 92 89 93 91
 Zähler: 10 25 5 0 0 0 0 0 0 0
 Innenzehner: 4
 weiteste: 666 (37), 583 (32), 551 (20)
 beste Teiler 79.1 (11.) 162.5 (21.) 175.3 (36.)
 Trefferlage 0.71 mm links, 0.64 mm hoch
 Streuwert 2.56, horizontal: 3.12, vertikal: 1.83

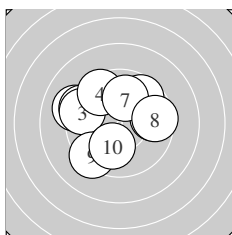
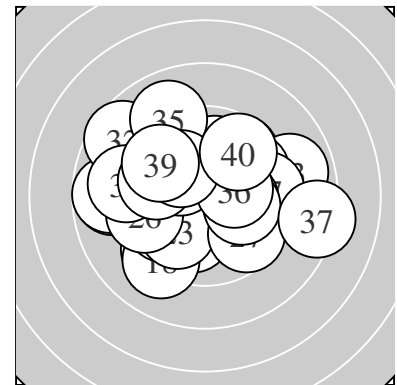

Serie 1:
 9.1 ↖ 9.4 ↖ 9.4 ↖ 9.5 ↖ 9.6 →
 9.7 ↗ 10.0 ↑ 9.6 → 9.3 ↘ 10.0 ↓
 beste Teiler 233.3 (10.) 249.3 (7.) 320.8 (6.)
 Trefferlage 0.75 mm links, 0.75 mm hoch
 Streuwert 2.51, horizontal: 2.93, vertikal: 1.99

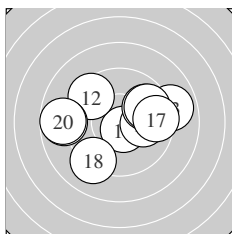

Serie 2:
 10.6 * 9.5 ↖ 8.9 → 10.0 → 9.8 ↗
 9.7 ↗ 9.5 → 9.1 ↘ 8.8 ← 8.7 ←
 beste Teiler 79.1 (11.) 229.5 (14.) 286.7 (15.)
 Trefferlage 0.00 mm , 0.25 mm hoch
 Streuwert 2.94, horizontal: 3.79, vertikal: 1.71

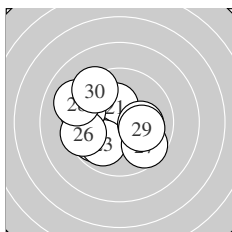

Serie 3:
 10.3 * 9.8 ↘ 9.9 ↘ 9.4 ↖ 10.1 →
 9.5 ← 9.6 ↘ 9.1 ↖ 10.1 → 9.4 ↖
 beste Teiler 162.5 (21.) 206.0 (25.) 223.2 (29.)
 Trefferlage 1.15 mm links, 0.00 mm
 Streuwert 2.22, horizontal: 2.55, vertikal: 1.83

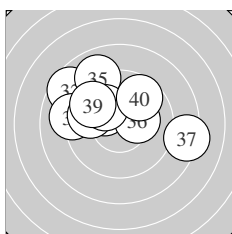

Serie 4:
 10.2 * 8.6 ↖ 9.1 ← 9.8 ↖ 9.0 ↖
 10.3 * 8.3 → 10.1 ↖ 9.7 ↖ 9.7 ↗
 beste Teiler 175.3 (36.) 181.2 (31.) 212.5 (38.)
 Trefferlage 0.96 mm links, 1.55 mm hoch
 Streuwert 2.70, horizontal: 3.46, vertikal: 1.63

Unterschrift des Schützen