

Ergebnis: **403.6** (390)
 Serien: 99.0 103.3 100.3 101.0
 Zaehler: 30 10 0 0 0 0 0 0 0 0
 Innenzehner: 18
 weiteste: 483 (2), 429 (23), 359 (27)
 beste Teiler 69.0 (17.) 79.1 (26.) 79.8 (12.)
 Trefferlage 0.58 mm links, 0.06 mm tief
 Streuwert 1.63, horizontal: 1.89, vertikal: 1.33

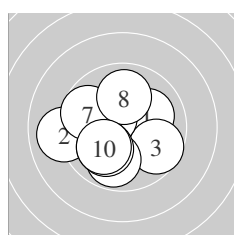

Serie 1:
 10.1 ↗ 9.0 ← 9.7 ↘ 10.4 * 10.1 ↙
 9.8 ↓ 9.7 ↖ 10.0 ↑ 10.1 ↘ 10.1 ↙
 beste Teiler 130.2 (4.) 219.6 (1.) 223.5 (5.)
 Trefferlage 0.89 mm links, 0.45 mm tief
 Streuwert 1.95, horizontal: 2.18, vertikal: 1.68

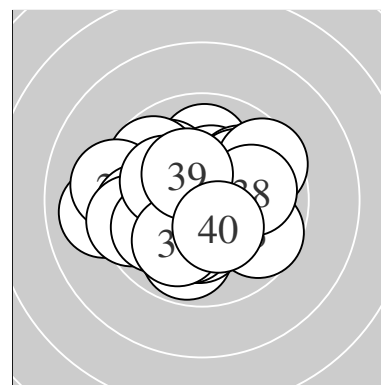
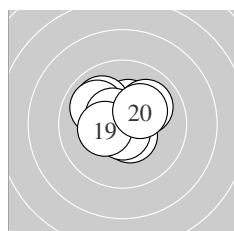

Serie 2:
 10.4 * 10.6 * 10.0 ↘ 10.0 ↗ 10.5 *
 10.0 ↖ 10.7 * 10.5 * 10.4 * 10.2 *
 beste Teiler 69.0 (17.) 79.8 (12.) 107.7 (18.)
 Trefferlage 0.11 mm links, 0.50 mm hoch
 Streuwert 1.20, horizontal: 1.34, vertikal: 1.04

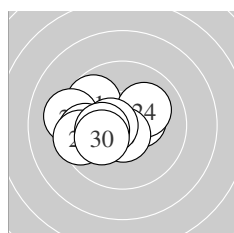

Serie 3:
 9.7 ↘ 10.4 * 9.2 ← 10.1 ↗ 9.7 ←
 10.6 * 9.5 ← 10.6 * 10.3 * 10.2 *
 beste Teiler 79.1 (26.) 98.0 (28.) 138.3 (22.)
 Trefferlage 1.43 mm links, 0.05 mm hoch
 Streuwert 1.57, horizontal: 1.99, vertikal: 0.99

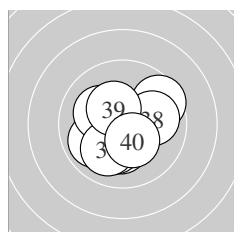

Serie 4:
 10.2 * 9.9 ↙ 10.1 ↖ 10.3 * 10.2 *
 10.0 ↘ 9.6 ↗ 10.0 → 10.4 * 10.3 *
 beste Teiler 146.4 (39.) 154.6 (40.) 172.5 (34.)
 Trefferlage 0.10 mm rechts, 0.36 mm tief
 Streuwert 1.63, horizontal: 1.78, vertikal: 1.45

Unterschrift des Schuetzen

Meyton Elektronik

Ergebnis: **403.8** (386)
 Serien: 100.9 100.9 101.7 100.3
 Zaehler: 26 14 0 0 0 0 0 0 0 0
 Innenzehner: 21
 weiteste: 469 (17), 447 (33), 417 (11)
 beste Teiler 46.6 (14.) 75.0 (18.) 76.2 (27.)
 Trefferlage 0.44 mm rechts, 0.21 mm tief
 Streuwert 1.69, horizontal: 1.85, vertikal: 1.51

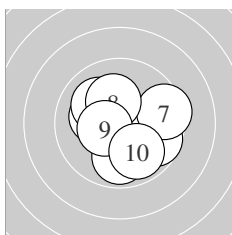
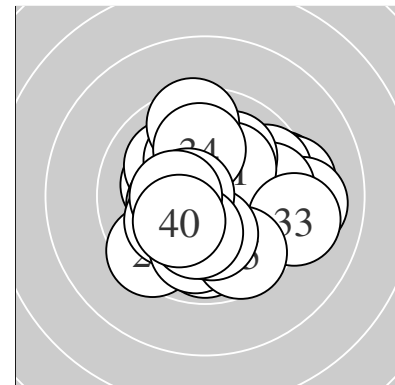

Serie 1:
 10.2 * 10.1 ↘ 10.6 * 9.7 ↘ 10.4 *
 9.9 ↓ 9.5 → 10.2 * 10.4 * 9.9 ↘
 beste Teiler 99.7 (3.) 127.1 (9.) 145.2 (5.)
 Trefferlage 0.42 mm rechts, 0.35 mm tief
 Streuwert 1.70, horizontal: 1.85, vertikal: 1.53

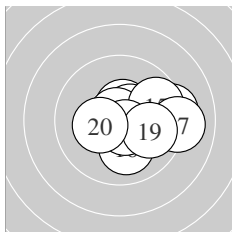

Serie 2:
 9.3 → 10.5 * 10.5 * 10.8 * 9.7 →
 10.1 ↓ 9.1 → 10.7 * 9.9 → 10.3 *
 beste Teiler 46.6 (14.) 75.0 (18.) 107.9 (12.)
 Trefferlage 1.44 mm rechts, 0.03 mm tief
 Streuwert 1.60, horizontal: 2.01, vertikal: 1.04

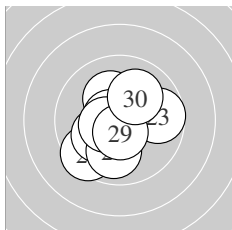

Serie 3:
 9.5 ↙ 10.1 ↙ 9.7 → 9.9 ↓ 10.6 *
 10.2 * 10.6 * 10.5 * 10.6 * 10.0 ↗
 beste Teiler 76.2 (27.) 79.2 (25.) 97.1 (29.)
 Trefferlage 0.35 mm links, 0.30 mm tief
 Streuwert 1.56, horizontal: 1.57, vertikal: 1.55

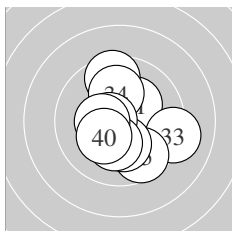

Serie 4:
 10.2 * 9.5 ↑ 9.2 → 10.0 ↑ 9.7 ↘
 10.2 * 10.6 * 10.2 * 10.4 * 10.3 *
 beste Teiler 83.2 (37.) 142.0 (39.) 175.3 (40.)
 Trefferlage 0.28 mm rechts, 0.16 mm tief
 Streuwert 1.87, horizontal: 1.74, vertikal: 1.99

Unterschrift des Schuetzen

Meyton Elektronik

Ergebnis: **402.4** (382)
 Serien: 102.3 99.1 100.4 100.6
 Zaehler: 23 16 1 0 0 0 0 0 0 0
 Innenzehner: 20
 weiteste: 524 (40), 472 (14), 405 (20)
 beste Teiler 13.9 (39.) 19.2 (1.) 41.7 (8.)
 Trefferlage 0.29 mm rechts, 0.36 mm hoch
 Streuwert 1.78, horizontal: 1.87, vertikal: 1.68

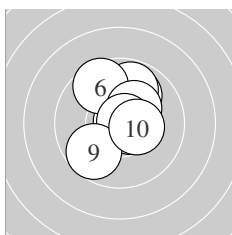
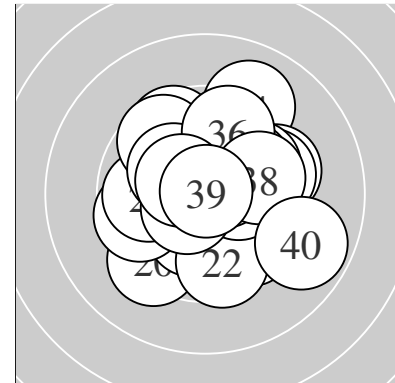

Serie 1:
 10.9 * 10.6 * 10.3 * 9.9 ↗ 9.8 ↗
 9.6 ↘ 10.3 * 10.8 * 9.7 ↙ 10.4 *
 beste Teiler 19.2 (1.) 41.7 (8.) 92.3 (2.)
 Trefferlage 0.32 mm rechts, 0.77 mm hoch
 Streuwert 1.42, horizontal: 1.19, vertikal: 1.62

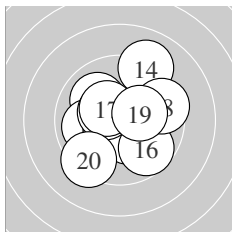

Serie 2:
 10.0 ↘ 10.0 ← 10.4 * 9.1 ↗ 10.4 *
 9.7 ↘ 10.4 * 9.5 → 10.3 * 9.3 ↙
 beste Teiler 133.8 (15.) 138.7 (17.) 148.9 (13.)
 Trefferlage 0.10 mm rechts, 0.18 mm hoch
 Streuwert 2.13, horizontal: 2.15, vertikal: 2.11

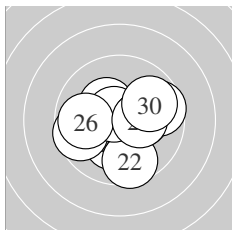

Serie 3:
 10.2 * 9.6 ↓ 9.6 ← 10.3 * 10.7 *
 9.9 ← 10.3 * 9.6 → 10.3 * 9.9 →
 beste Teiler 65.0 (25.) 158.7 (24.) 163.0 (29.)
 Trefferlage 0.17 mm rechts, 0.21 mm tief
 Streuwert 1.82, horizontal: 2.13, vertikal: 1.44

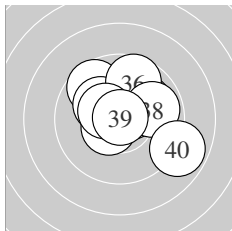

Serie 4:
 9.6 ↘ 10.2 * 10.5 * 10.0 ↗ 10.5 *
 9.7 ↗ 10.4 * 9.9 → 10.9 * 8.9 ↘
 beste Teiler 13.9 (39.) 109.0 (35.) 109.8 (33.)
 Trefferlage 0.58 mm rechts, 0.71 mm hoch
 Streuwert 1.84, horizontal: 2.10, vertikal: 1.53

Unterschrift des Schuetzen

Meyton Elektronik

Ergebnis: **394.0** (379)
 Serien: 98.7 96.6 97.1 101.6
 Zaehler: 22 16 1 1 0 0 0 0 0 0
 Innenzehner: 15
 weiteste: 771 (14), 580 (7), 446 (24)
 beste Teiler 120.0 (6.) 133.2 (31.) 143.1 (35.)
 Trefferlage 0.28 mm links, 1.11 mm hoch
 Streuwert 2.05, horizontal: 1.84, vertikal: 2.24

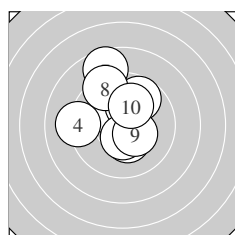
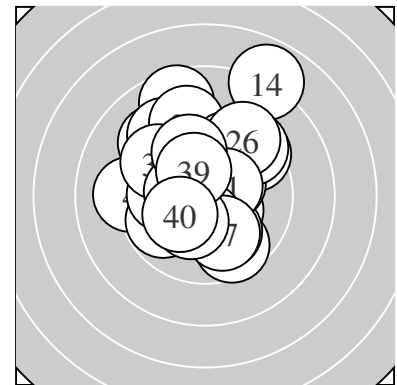

Serie 1:
 10.4 * 9.7 ↗ 10.2 * 9.2 ← 10.3 *
 10.5 * 8.6 ↘ 9.3 ↘ 10.4 * 10.1 ↗
 beste Teiler 120.0 (6.) 143.2 (1.) 150.3 (9.)
 Trefferlage 0.40 mm links, 1.33 mm hoch
 Streuwert 2.06, horizontal: 1.82, vertikal: 2.27

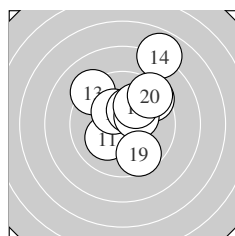

Serie 2:
 10.1 ↖ 9.4 ↗ 9.2 ↘ 7.9 ↗ 10.3 *
 10.3 * 10.3 * 10.1 ↗ 9.6 ↘ 9.4 ↗
 beste Teiler 152.6 (16.) 153.4 (15.) 157.5 (17.)
 Trefferlage 0.88 mm rechts, 1.62 mm hoch
 Streuwert 2.38, horizontal: 2.10, vertikal: 2.62

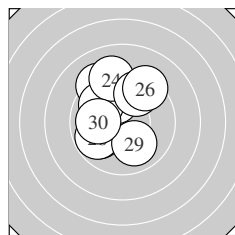

Serie 3:
 9.2 ↘ 10.1 ↘ 9.9 ↘ 9.2 ↑ 9.7 ↗
 9.3 ↗ 9.9 ↖ 9.8 ↖ 10.0 ↘ 10.0 ←
 beste Teiler 217.9 (22.) 240.7 (29.) 243.1 (30.)
 Trefferlage 0.87 mm links, 1.30 mm hoch
 Streuwert 2.11, horizontal: 1.83, vertikal: 2.36

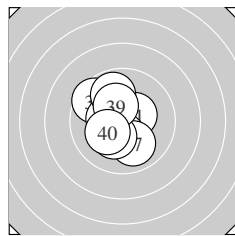

Serie 4:
 10.4 * 10.2 * 9.6 ↘ 10.4 * 10.4 *
 9.8 ↘ 10.0 ↘ 10.3 * 10.3 * 10.2 *
 beste Teiler 133.2 (31.) 143.1 (35.) 145.0 (34.)
 Trefferlage 0.73 mm links, 0.20 mm hoch
 Streuwert 1.47, horizontal: 1.21, vertikal: 1.69

Unterschrift des Schuetzen

Ergebnis: **404.3** (386)^{QF}
 Serien: 98.3 101.0 104.3 100.7
 Zaehler: 28 10 2 0 0 0 0 0 0 0
 Innenzehner: 25
 weiteste: 626 (5), 510 (16), 439 (35)
 beste Teiler 30.4 (24.) 52.4 (26.) 74.2 (28.)
 Trefferlage 0.72 mm rechts, 0.62 mm tief
 Streuwert 1.62, horizontal: 2.04, vertikal: 1.04

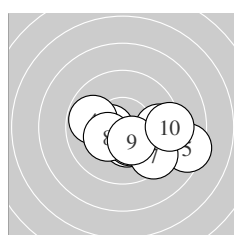
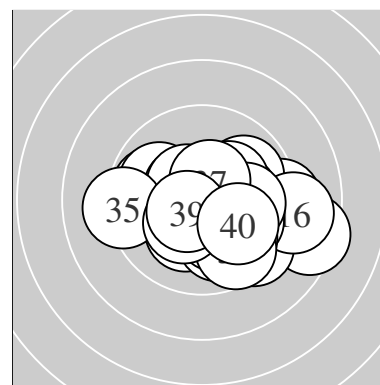

Serie 1:
 10.4 * 10.5 * 10.3 * 9.8 ← 8.4 →
 9.6 → 9.4 ↘ 10.3 * 10.4 * 9.2 →
 beste Teiler 120.9 (2.) 148.7 (1.) 148.9 (9.)
 Trefferlage 1.32 mm rechts, 0.88 mm tief
 Streuwert 2.07, horizontal: 2.76, vertikal: 0.99

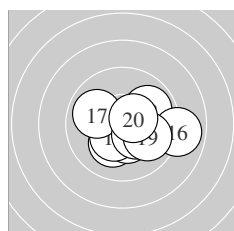

Serie 2:
 10.2 * 9.9 ↗ 10.4 * 10.6 * 10.4 *
 8.9 → 9.9 ← 10.3 * 9.9 ↘ 10.5 *
 beste Teiler 77.6 (14.) 113.2 (20.) 141.1 (15.)
 Trefferlage 0.88 mm rechts, 0.46 mm tief
 Streuwert 1.64, horizontal: 2.06, vertikal: 1.05

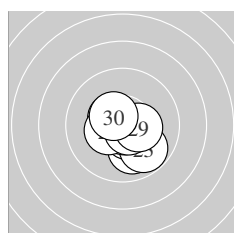

Serie 3:
 10.0 ↓ 10.5 * 9.8 ↘ 10.8 * 10.5 *
 10.7 * 10.4 * 10.7 * 10.4 * 10.5 *
 beste Teiler 30.4 (24.) 52.4 (26.) 74.2 (28.)
 Trefferlage 0.20 mm rechts, 0.55 mm tief
 Streuwert 1.04, horizontal: 1.06, vertikal: 1.02

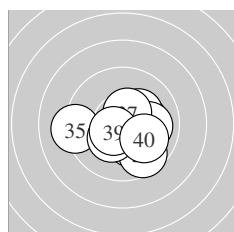

Serie 4:
 10.2 * 10.2 * 10.2 * 9.6 ↓ 9.2 ←
 10.0 → 10.5 * 10.3 * 10.5 * 10.0 ↘
 beste Teiler 104.8 (39.) 115.3 (37.) 162.8 (38.)
 Trefferlage 0.46 mm rechts, 0.59 mm tief
 Streuwert 1.69, horizontal: 2.07, vertikal: 1.20

QF – Schütze hat sich fürs Finale qualifiziert

Unterschrift des Schuetzen

Meyton Elektronik

Ergebnis: **393.7** (374)
 Serien: 98.3 99.1 98.7 97.6
 Zaehler: 16 22 2 0 0 0 0 0 0 0
 Innenzehner: 11
 weiteste: 530 (31), 520 (21), 439 (24)
 beste Teiler 16.1 (2.) 40.4 (23.) 92.6 (27.)
 Trefferlage 0.36 mm links, 0.23 mm tief
 Streuwert 2.13, horizontal: 2.25, vertikal: 2.00

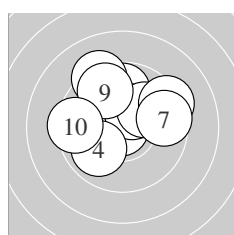
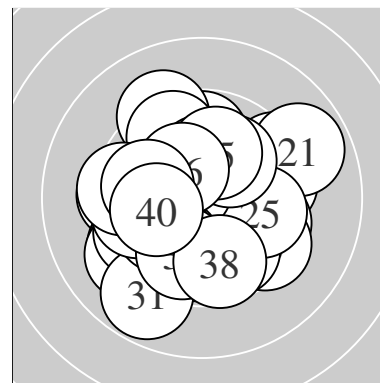

Serie 1:
 9.8 ↑ 10.9 * 10.4 * 9.9 ↙ 10.1 ↗
 9.3 ↗ 9.6 → 9.2 ↘ 9.7 ↘ 9.4 ←
 beste Teiler 16.1 (2.) 145.4 (3.) 225.6 (5.)
 Trefferlage 0.02 mm rechts, 1.34 mm hoch
 Streuwert 2.06, horizontal: 2.39, vertikal: 1.68

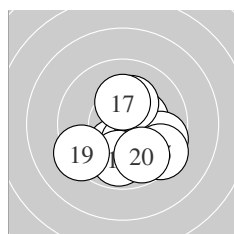

Serie 2:
 10.2 * 10.3 * 10.3 * 9.6 → 9.4 ↘
 10.2 * 10.2 * 9.8 ↓ 9.3 ↙ 9.8 ↘
 beste Teiler 151.5 (13.) 154.6 (12.) 177.0 (17.)
 Trefferlage 0.59 mm rechts, 1.03 mm tief
 Streuwert 1.80, horizontal: 1.88, vertikal: 1.71

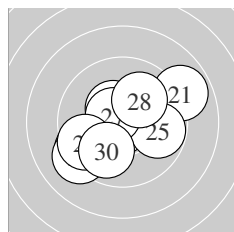

Serie 3:
 8.9 ↗ 9.4 ↙ 10.8 * 9.2 ↙ 9.8 →
 10.4 * 10.6 * 10.1 ↗ 9.6 ↙ 9.9 ↙
 beste Teiler 40.4 (23.) 92.6 (27.) 135.0 (26.)
 Trefferlage 0.38 mm links, 0.40 mm tief
 Streuwert 2.28, horizontal: 2.68, vertikal: 1.80

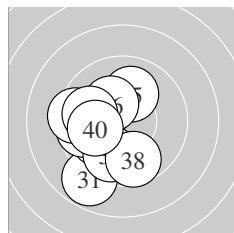

Serie 4:
 8.8 ↙ 10.0 ↙ 9.7 ← 9.4 ← 10.0 ↑
 10.3 * 9.8 ↓ 9.7 ↓ 9.9 ← 10.0 ←
 beste Teiler 168.3 (36.) 226.8 (35.) 228.2 (40.)
 Trefferlage 1.67 mm links, 0.84 mm tief
 Streuwert 1.86, horizontal: 1.56, vertikal: 2.12

Unterschrift des Schuetzen

Meyton Elektronik

Ergebnis: **410.2** (390)^{QF}
 Serien: 100.9 103.6 102.6 103.1
 Zaehler: 30 10 0 0 0 0 0 0 0 0
 Innenzehner: 25
 weiteste: 464 (3), 457 (18), 389 (10)
 beste Teiler 22.8 (24.) 41.0 (14.) 43.8 (15.)
 Trefferlage 0.37 mm rechts, 0.37 mm hoch
 Streuwert 1.44, horizontal: 1.34, vertikal: 1.54

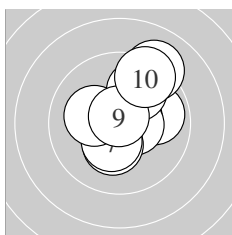
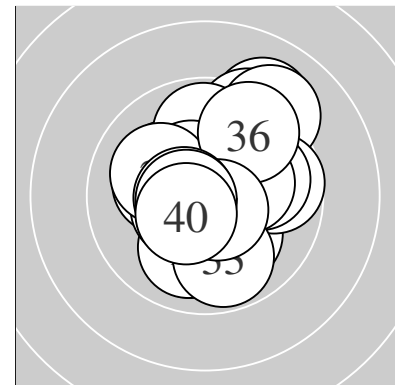

Serie 1:
 9.9 → 10.5 * 9.1 ↗ 10.5 * 9.9 ↗
 10.3 * 10.4 * 10.2 * 10.7 * 9.4 ↗
 beste Teiler 51.3 (9.) 101.0 (2.) 104.6 (4.)
 Trefferlage 0.71 mm rechts, 0.88 mm hoch
 Streuwert 1.65, horizontal: 1.45, vertikal: 1.83

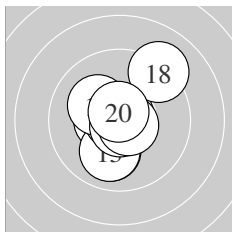

Serie 2:
 10.5 * 10.0 ↓ 10.0 ↓ 10.8 * 10.8 *
 10.2 * 10.8 * 9.1 ↗ 10.7 * 10.7 *
 beste Teiler 41.0 (14.) 43.8 (15.) 47.0 (17.)
 Trefferlage 0.07 mm links, 0.02 mm hoch
 Streuwert 1.47, horizontal: 1.24, vertikal: 1.67

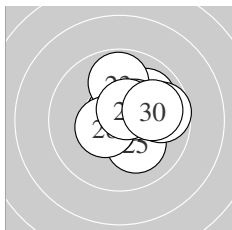

Serie 3:
 10.0 ↗ 10.7 * 9.8 ↑ 10.9 * 10.1 ↓
 10.4 * 9.7 → 10.5 * 10.6 * 9.9 →
 beste Teiler 22.8 (24.) 51.4 (22.) 95.4 (29.)
 Trefferlage 0.86 mm rechts, 0.54 mm hoch
 Streuwert 1.25, horizontal: 1.31, vertikal: 1.18

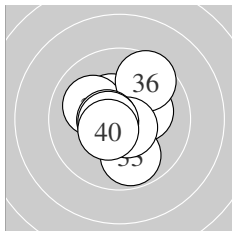

Serie 4:
 10.2 * 10.6 * 9.8 ↓ 10.5 * 10.1 ↖
 9.6 ↗ 10.6 * 10.6 * 10.6 * 10.5 *
 beste Teiler 77.5 (32.) 83.5 (37.) 86.3 (39.)
 Trefferlage 0.00 mm , 0.03 mm hoch
 Streuwert 1.36, horizontal: 1.26, vertikal: 1.46

QF – Schütze hat sich fürs Finale qualifiziert

Unterschrift des Schuetzen

Meyton Elektronik

Ergebnis: **414.1** (397)^{QF}
 Serien: 102.3 104.3 103.2 104.3
 Zaehler: 37 3 0 0 0 0 0 0 0 0
 Innenzehner: 29
 weiteste: 350 (5), 301 (32), 287 (29)
 beste Teiler 7.0 (20.) 36.6 (38.) 40.3 (40.)
 Trefferlage 0.02 mm rechts, 0.36 mm hoch
 Streuwert 1.17, horizontal: 0.78, vertikal: 1.46

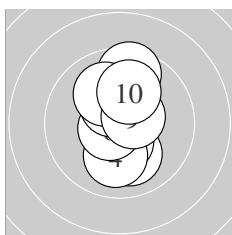
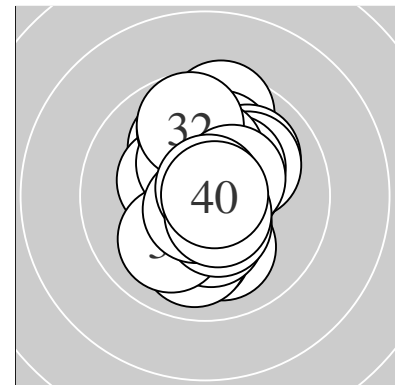

Serie 1:
 10.0 ↓ 10.8 * 10.4 * 10.0 ↓ 9.6 ↑
 10.6 * 10.4 * 10.0 ↘ 10.5 * 10.0 ↑
 beste Teiler 47.3 (2.) 76.9 (6.) 105.5 (9.)
 Trefferlage 0.03 mm rechts, 0.30 mm hoch
 Streuwert 1.44, horizontal: 0.69, vertikal: 1.92

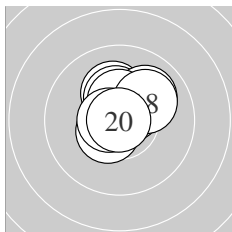

Serie 2:
 10.5 * 10.7 * 10.5 * 10.2 * 10.3 *
 10.0 ↗ 10.4 * 10.1 ↗ 10.7 * 10.9 *
 beste Teiler 7.0 (20.) 57.0 (12.) 74.0 (19.)
 Trefferlage 0.12 mm rechts, 0.77 mm hoch
 Streuwert 0.93, horizontal: 0.97, vertikal: 0.88

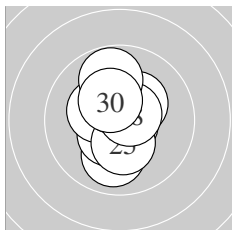

Serie 3:
 10.0 ↓ 10.5 * 10.7 * 10.3 * 10.3 *
 10.3 * 10.4 * 10.6 * 9.8 ↑ 10.3 *
 beste Teiler 54.9 (23.) 82.4 (28.) 122.2 (22.)
 Trefferlage 0.17 mm links, 0.24 mm hoch
 Streuwert 1.24, horizontal: 0.79, vertikal: 1.57

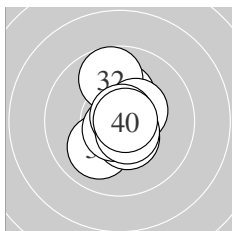

Serie 4:
 10.2 * 9.7 ↑ 10.0 ↙ 10.4 * 10.7 *
 10.7 * 10.4 * 10.8 * 10.6 * 10.8 *
 beste Teiler 36.6 (38.) 40.3 (40.) 53.9 (35.)
 Trefferlage 0.11 mm rechts, 0.14 mm hoch
 Streuwert 1.12, horizontal: 0.73, vertikal: 1.41

QF – Schütze hat sich fürs Finale qualifiziert

Unterschrift des Schuetzen

Meyton Elektronik

Ergebnis: **398.4** (380)
 Serien: 100.0 99.5 101.1 97.8
 Zaehler: 22 16 2 0 0 0 0 0 0 0
 Innenzehner: 16
 weiteste: 528 (38), 506 (39), 477 (12)
 beste Teiler 32.1 (18.) 32.2 (6.) 38.0 (28.)
 Trefferlage 0.93 mm rechts, 0.14 mm tief
 Streuwert 1.87, horizontal: 1.93, vertikal: 1.80

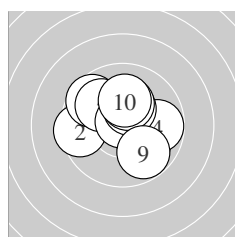
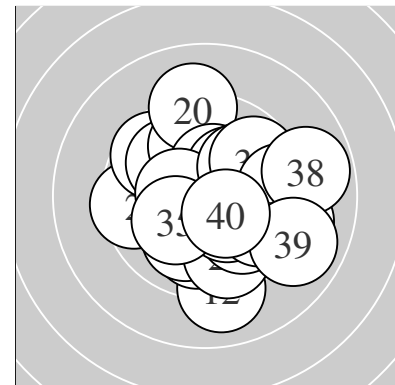

Serie 1:
 9.9 ↘ 9.5 ← 9.6 ↖ 9.8 → 10.0 ↗
 10.8 * 10.3 * 10.2 * 9.8 ↘ 10.1 ↑
 beste Teiler 32.2 (6.) 151.3 (7.) 186.2 (8.)
 Trefferlage 0.03 mm links, 0.47 mm hoch
 Streuwert 1.85, horizontal: 2.07, vertikal: 1.61

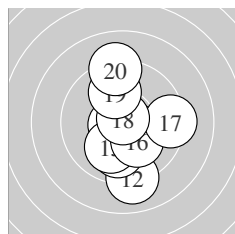

Serie 2:
 10.6 * 9.0 ↓ 10.7 * 9.9 ↓ 10.0 ↙
 10.2 * 9.3 → 10.8 * 9.9 ↑ 9.1 ↑
 beste Teiler 32.1 (18.) 73.6 (13.) 99.0 (11.)
 Trefferlage 0.36 mm rechts, 0.42 mm tief
 Streuwert 2.12, horizontal: 1.51, vertikal: 2.59

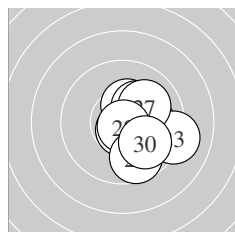

Serie 3:
 10.3 * 10.0 → 9.1 ↗ 10.7 * 10.4 *
 10.2 * 10.0 ↗ 10.8 * 9.7 ↓ 9.9 ↘
 beste Teiler 38.0 (28.) 66.1 (24.) 147.2 (25.)
 Trefferlage 1.42 mm rechts, 0.45 mm tief
 Streuwert 1.38, horizontal: 1.29, vertikal: 1.46

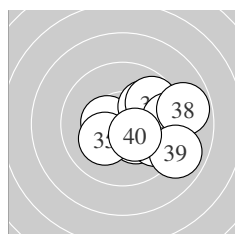

Serie 4:
 10.3 * 10.4 * 10.0 ↗ 9.7 ↘ 10.2 *
 9.7 ↗ 9.4 → 8.8 → 8.9 ↘ 10.4 *
 beste Teiler 131.9 (32.) 138.2 (40.) 159.8 (31.)
 Trefferlage 1.99 mm rechts, 0.18 mm tief
 Streuwert 1.87, horizontal: 2.24, vertikal: 1.41

Unterschrift des Schuetzen

Meyton Elektronik

Ergebnis: **392.1** (375)
 Serien: 98.3 99.3 95.1 99.4
 Zaehler: 18 19 3 0 0 0 0 0 0 0
 Innenzehner: 13
 weiteste: 563 (10), 538 (27), 506 (40)
 beste Teiler 25.0 (20.) 30.0 (36.) 38.2 (37.)
 Trefferlage 1.17 mm rechts, 0.40 mm tief
 Streuwert 2.15, horizontal: 2.65, vertikal: 1.48

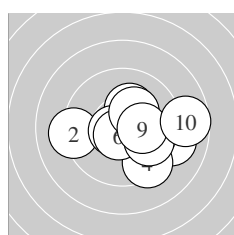
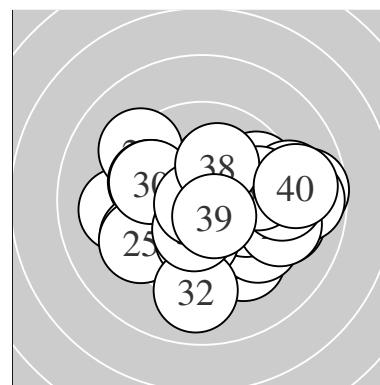

Serie 1:
 10.2 * 9.2 ← 9.2 → 9.4 ↘ 10.6 *
 10.6 * 10.3 * 9.9 ↘ 10.2 * 8.7 →
 beste Teiler 76.0 (6.) 86.7 (5.) 168.4 (7.)
 Trefferlage 1.24 mm rechts, 0.36 mm tief
 Streuwert 2.20, horizontal: 2.78, vertikal: 1.38

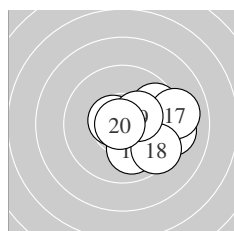

Serie 2:
 9.9 ↘ 9.2 → 9.7 ↗ 10.6 * 10.1 ↘
 10.0 ↓ 9.1 → 9.5 ↘ 10.3 * 10.9 *
 beste Teiler 25.0 (20.) 91.1 (14.) 152.0 (19.)
 Trefferlage 1.95 mm rechts, 0.46 mm tief
 Streuwert 1.59, horizontal: 1.82, vertikal: 1.33

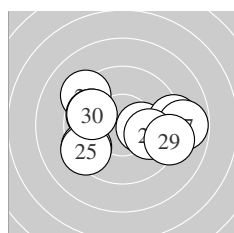

Serie 3:
 9.3 ↘ 10.3 * 9.8 ↖ 9.4 ↙ 9.4 ↙
 9.1 → 8.8 → 10.0 → 9.2 → 9.8 ↖
 beste Teiler 167.2 (22.) 250.1 (28.) 289.3 (30.)
 Trefferlage 0.28 mm rechts, 0.14 mm tief
 Streuwert 2.80, horizontal: 3.68, vertikal: 1.49

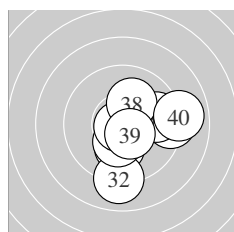

Serie 4:
 10.1 ↓ 9.0 ↓ 9.2 → 10.3 * 9.7 →
 10.8 * 10.8 * 10.1 ↑ 10.5 * 8.9 →
 beste Teiler 30.0 (36.) 38.2 (37.) 108.6 (39.)
 Trefferlage 1.24 mm rechts, 0.65 mm tief
 Streuwert 1.97, horizontal: 2.07, vertikal: 1.86

Unterschrift des Schuetzen

Meyton Elektronik

Ergebnis: **409.4** (387)^{QF}
 Serien: 102.6 101.9 101.7 103.2
 Zaehler: 27 13 0 0 0 0 0 0 0 0
 Innenzehner: 26
 weiteste: 449 (28), 328 (36), 327 (21)
 beste Teiler 35.0 (16.) 45.9 (35.) 56.3 (40.)
 Trefferlage 0.19 mm links, 0.44 mm hoch
 Streuwert 1.42, horizontal: 1.69, vertikal: 1.09

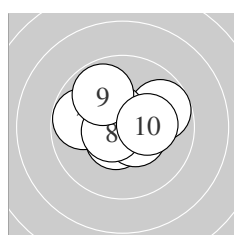
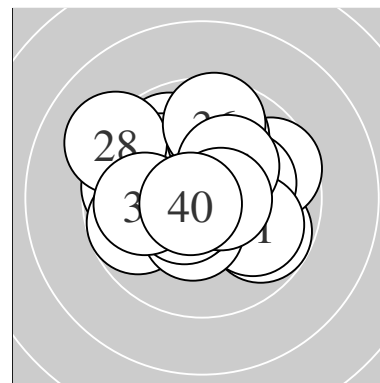

Serie 1:
 10.3 * 9.7 → 10.6 * 10.5 * 10.6 *
 10.5 * 9.8 ← 10.6 * 9.8 ↖ 10.2 *
 beste Teiler 82.2 (8.) 92.6 (3.) 98.1 (5.)
 Trefferlage 0.26 mm links, 0.51 mm hoch
 Streuwert 1.35, horizontal: 1.65, vertikal: 0.97

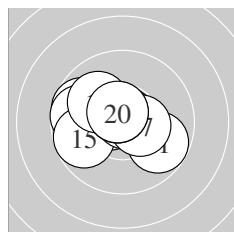

Serie 2:
 9.8 ↘ 9.7 ← 9.7 ← 10.6 * 9.7 ←
 10.8 * 10.4 * 10.6 * 10.0 ↘ 10.6 *
 beste Teiler 35.0 (16.) 80.9 (18.) 82.7 (20.)
 Trefferlage 0.81 mm links, 0.20 mm hoch
 Streuwert 1.48, horizontal: 1.88, vertikal: 0.92

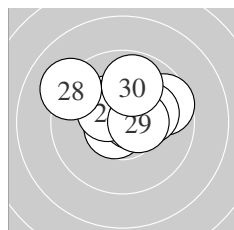

Serie 3:
 9.6 → 10.7 * 10.7 * 10.3 * 10.4 *
 10.3 * 10.2 * 9.2 ↘ 10.5 * 9.8 ↑
 beste Teiler 72.2 (22.) 73.3 (23.) 115.0 (29.)
 Trefferlage 0.25 mm rechts, 0.97 mm hoch
 Streuwert 1.53, horizontal: 1.93, vertikal: 0.98

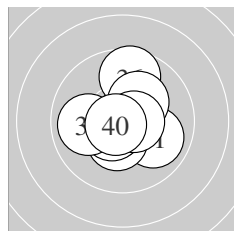

Serie 4:
 9.9 ↘ 10.4 * 10.6 * 10.5 * 10.8 *
 9.6 ↑ 10.2 * 9.9 ← 10.6 * 10.7 *
 beste Teiler 45.9 (35.) 56.3 (40.) 76.4 (33.)
 Trefferlage 0.03 mm rechts, 0.06 mm hoch
 Streuwert 1.32, horizontal: 1.29, vertikal: 1.36

QF – Schütze hat sich fürs Finale qualifiziert

Unterschrift des Schuetzen

Meyton Elektronik

Ergebnis: **410.9** (394)^{QF}
 Serien: 102.8 103.2 102.0 102.9
 Zaehler: 34 6 0 0 0 0 0 0 0 0
 Innenzehner: 29
 weiteste: 467 (29), 363 (7), 316 (24)
 beste Teiler 52.6 (1.) 56.3 (14.) 63.8 (21.)
 Trefferlage 0.01 mm rechts, 0.04 mm tief
 Streuwert 1.37, horizontal: 1.66, vertikal: 1.00

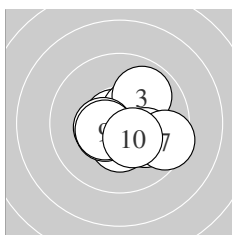
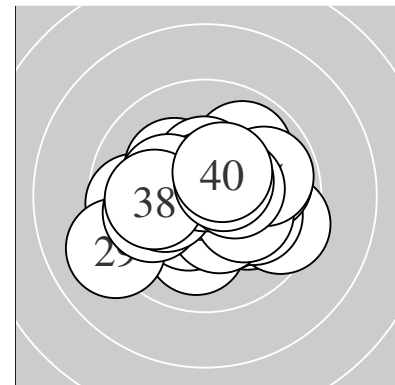

Serie 1:
 10.7 * 10.4 * 9.9 ↗ 10.4 * 10.4 *
 10.1 ↘ 9.5 ↘ 10.5 * 10.5 * 10.4 *
 beste Teiler 52.6 (1.) 121.2 (9.) 124.5 (8.)
 Trefferlage 0.51 mm rechts, 0.30 mm tief
 Streuwert 1.34, horizontal: 1.55, vertikal: 1.10

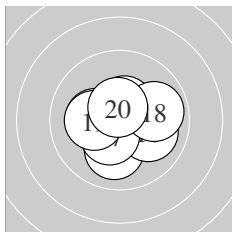

Serie 2:
 10.2 * 10.6 * 10.1 ↓ 10.7 * 10.5 *
 10.0 ↘ 10.4 * 9.9 → 10.2 * 10.6 *
 beste Teiler 56.3 (14.) 90.1 (12.) 97.0 (20.)
 Trefferlage 0.00 mm , 0.17 mm tief
 Streuwert 1.28, horizontal: 1.47, vertikal: 1.06

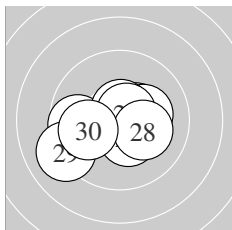

Serie 3:
 10.7 * 10.4 * 10.2 * 9.7 ← 10.4 *
 10.6 * 10.7 * 10.2 * 9.1 ← 10.0 ←
 beste Teiler 63.8 (21.) 72.8 (27.) 81.4 (26.)
 Trefferlage 0.30 mm links, 0.34 mm tief
 Streuwert 1.64, horizontal: 2.09, vertikal: 0.98

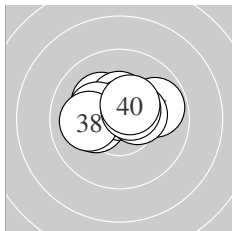

Serie 4:
 10.2 * 10.2 * 10.4 * 10.7 * 9.8 →
 10.4 * 10.3 * 10.0 ← 10.5 * 10.4 *
 beste Teiler 65.0 (34.) 107.6 (39.) 132.4 (40.)
 Trefferlage 0.15 mm links, 0.63 mm hoch
 Streuwert 1.20, horizontal: 1.60, vertikal: 0.55

QF – Schütze hat sich fürs Finale qualifiziert

Unterschrift des Schuetzen

Meyton Elektronik

LG 40 ZR – Wertung – Frauen

StandNr: 113

Mair,, Romana #70606020

StartNr: 61

12. Maerz 2017 12:20

SG_Innervillgraten

Ergebnis: **0.0** (0)_{DNS}
Serien:
Zaehler: 0 0 0 0 0 0 0 0 0 0
Innenzehner: 0
weiteste:
~~beste Teiler~~ – Schütze ist nicht zum Wettkampf angetreten
Trefferlage 0.00 mm , 0.00 mm
Streuwert
Unterschrift des Schuetzen

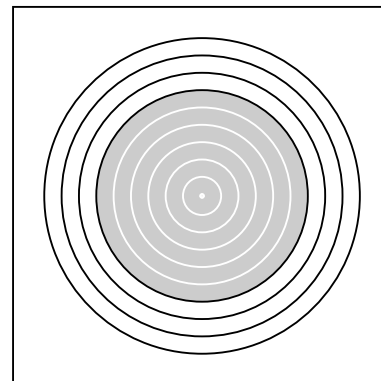

Ergebnis: **391.0** (371)
 Serien: 96.4 95.5 101.9 97.2
 Zaehler: 16 21 1 2 0 0 0 0 0 0
 Innenzehner: 11
 weiteste: 835 (35), 811 (18), 503 (6)
 beste Teiler 46.0 (28.) 53.8 (21.) 76.1 (22.)
 Trefferlage 1.12 mm links, 1.08 mm hoch
 Streuwert 2.18, horizontal: 2.78, vertikal: 1.32

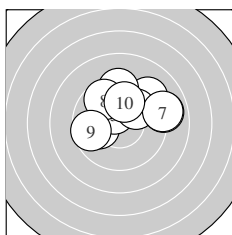
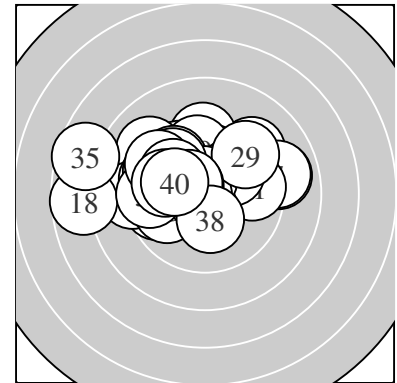

Serie 1:
 9.3 ↗ 10.0 ← 10.5 * 10.0 ↗ 9.4 ↑
 8.9 → 9.0 → 9.7 ↘ 9.6 ← 10.0 ↑
 beste Teiler 118.2 (3.) 234.0 (2.) 240.4 (4.)
 Trefferlage 0.72 mm rechts, 1.53 mm hoch
 Streuwert 2.27, horizontal: 2.86, vertikal: 1.47

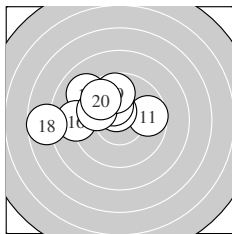

Serie 2:
 9.7 → 9.9 ↖ 10.5 * 9.1 ↘ 10.3 *
 9.0 ← 9.9 ↘ 7.7 ← 9.7 ↑ 9.7 ↘
 beste Teiler 103.1 (13.) 175.9 (15.) 271.6 (12.)
 Trefferlage 2.05 mm links, 1.43 mm hoch
 Streuwert 2.31, horizontal: 3.03, vertikal: 1.24

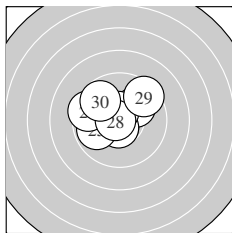

Serie 3:
 10.7 * 10.6 * 10.0 ↗ 10.6 * 9.9 ←
 9.5 ↖ 10.6 * 10.8 * 9.5 ↗ 9.7 ↘
 beste Teiler 46.0 (28.) 53.8 (21.) 76.1 (22.)
 Trefferlage 0.49 mm links, 0.50 mm hoch
 Streuwert 1.61, horizontal: 1.87, vertikal: 1.30

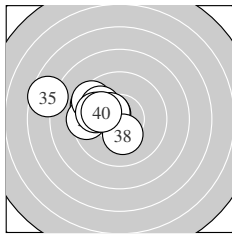

Serie 4:
 9.5 ↖ 9.5 ← 9.5 ↘ 10.5 * 7.6 ↖
 9.9 ↘ 10.4 * 10.3 * 9.9 ↖ 10.1 ↖
 beste Teiler 115.0 (34.) 129.0 (37.) 172.5 (38.)
 Trefferlage 2.65 mm links, 0.85 mm hoch
 Streuwert 1.78, horizontal: 2.23, vertikal: 1.16

Unterschrift des Schuetzen

Meyton Elektronik

Ergebnis: **408.2** (391)^{QF}
 Serien: 101.2 101.6 104.0 101.4
 Zaehler: 31 9 0 0 0 0 0 0 0 0
 Innenzehner: 28
 weiteste: 420 (38), 376 (40), 368 (12)
 beste Teiler 41.1 (28.) 52.6 (14.) 72.3 (4.)
 Trefferlage 0.12 mm rechts, 0.41 mm hoch
 Streuwert 1.46, horizontal: 1.72, vertikal: 1.14

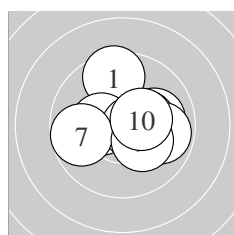
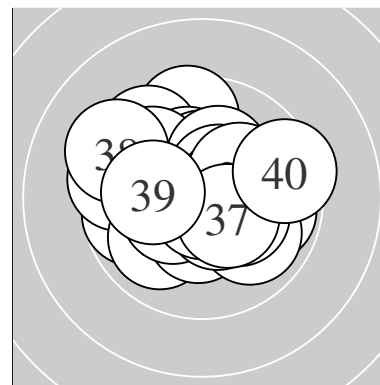

Serie 1:
 9.5 ↑ 10.0 → 10.3 * 10.7 * 10.3 *
 10.3 * 9.7 ← 9.8 → 10.2 * 10.4 *
 beste Teiler 72.3 (4.) 141.3 (10.) 153.2 (3.)
 Trefferlage 0.64 mm rechts, 0.23 mm hoch
 Streuwert 1.55, horizontal: 1.80, vertikal: 1.25

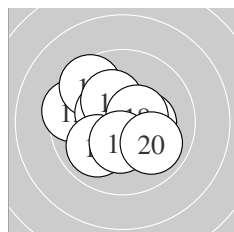

Serie 2:
 10.3 * 9.5 ← 9.6 ↖ 10.7 * 10.4 *
 10.3 * 10.0 ↙ 10.5 * 10.4 * 9.9 ↘
 beste Teiler 52.6 (14.) 112.5 (18.) 136.4 (15.)
 Trefferlage 0.47 mm links, 0.16 mm hoch
 Streuwert 1.62, horizontal: 1.82, vertikal: 1.40

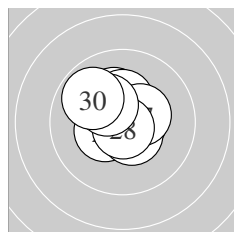

Serie 3:
 10.4 * 10.6 * 10.2 * 10.5 * 10.6 *
 10.3 * 10.4 * 10.8 * 10.3 * 9.9 ↖
 beste Teiler 41.1 (28.) 83.4 (25.) 98.1 (22.)
 Trefferlage 0.19 mm links, 0.56 mm hoch
 Streuwert 1.04, horizontal: 1.08, vertikal: 0.98

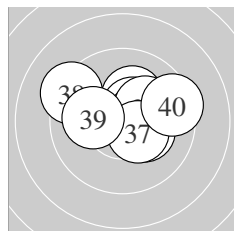

Serie 4:
 10.5 * 10.2 * 10.5 * 10.5 * 10.3 *
 10.2 * 10.4 * 9.3 ↖ 10.1 ← 9.4 →
 beste Teiler 114.8 (34.) 117.6 (33.) 122.4 (31.)
 Trefferlage 0.52 mm rechts, 0.69 mm hoch
 Streuwert 1.58, horizontal: 2.03, vertikal: 0.93

QF – Schütze hat sich fürs Finale qualifiziert

Unterschrift des Schuetzen

Meyton Elektronik

Ergebnis: **406.8** (388)^{QF}
 Serien: 102.1 103.4 100.9 100.4
 Zaehler: 28 12 0 0 0 0 0 0 0 0
 Innenzehner: 26
 weiteste: 485 (21), 471 (28), 334 (40)
 beste Teiler 29.0 (27.) 48.8 (39.) 59.5 (3.)
 Trefferlage 0.13 mm links, 0.24 mm tief
 Streuwert 1.58, horizontal: 1.85, vertikal: 1.24

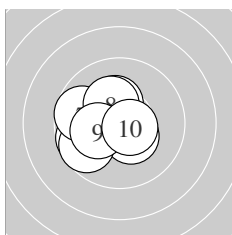
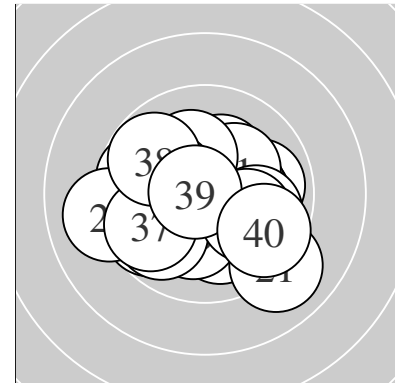

Serie 1:
 9.7 ← 10.5 * 10.7 * 10.3 * 10.4 *
 9.7 ← 9.7 ← 10.3 * 10.2 * 10.6 *
 beste Teiler 59.5 (3.) 88.7 (10.) 102.5 (2.)
 Trefferlage 1.06 mm links, 0.01 mm hoch
 Streuwert 1.31, horizontal: 1.44, vertikal: 1.16

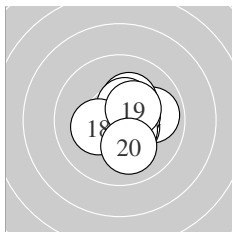

Serie 2:
 9.9 → 10.5 * 10.5 * 10.5 * 10.3 *
 10.5 * 10.5 * 10.2 * 10.4 * 10.1 ↓
 beste Teiler 107.2 (14.) 111.0 (17.) 113.0 (13.)
 Trefferlage 0.73 mm rechts, 0.13 mm hoch
 Streuwert 1.08, horizontal: 1.03, vertikal: 1.12

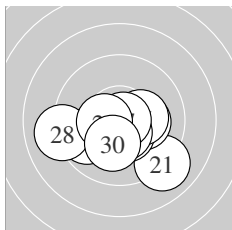

Serie 3:
 9.0 ↘ 10.2 * 10.5 * 9.8 ← 10.3 *
 10.5 * 10.8 * 9.1 ← 10.5 * 10.2 *
 beste Teiler 29.0 (27.) 104.7 (26.) 122.6 (29.)
 Trefferlage 0.08 mm links, 0.98 mm tief
 Streuwert 1.81, horizontal: 2.32, vertikal: 1.09

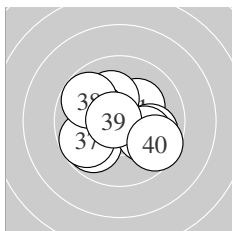

Serie 4:
 10.2 * 10.2 * 9.9 → 10.2 * 9.8 ←
 10.1 → 9.8 ← 9.8 ↖ 10.8 * 9.6 →
 beste Teiler 48.8 (39.) 182.4 (31.) 182.5 (34.)
 Trefferlage 0.13 mm links, 0.16 mm tief
 Streuwert 1.81, horizontal: 2.12, vertikal: 1.43

QF – Schütze hat sich fürs Finale qualifiziert

Unterschrift des Schuetzen

Meyton Elektronik

Ergebnis: **402.0** (385)
 Serien: 99.9 101.6 101.3 99.2
 Zaehler: 26 13 1 0 0 0 0 0 0 0
 Innenzehner: 20
 weiteste: 515 (36), 397 (9), 391 (6)
 beste Teiler 68.5 (12.) 70.4 (22.) 75.5 (29.)
 Trefferlage 0.76 mm links, 0.35 mm hoch
 Streuwert 1.69, horizontal: 1.93, vertikal: 1.42

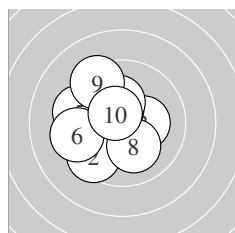
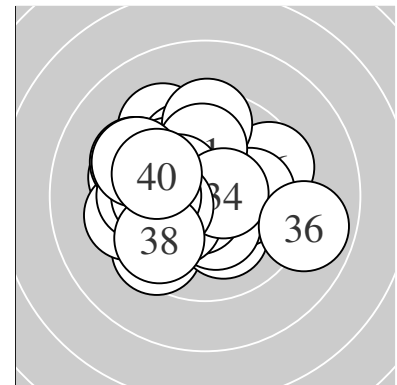

Serie 1:
 10.5 * 9.5 ↙ 10.3 * 10.5 * 9.5 ↖
 9.4 ← 10.2 * 10.1 ↘ 9.4 ↗ 10.5 *
 beste Teiler 102.8 (10.) 113.0 (1.) 120.4 (4.)
 Trefferlage 1.05 mm links, 0.13 mm hoch
 Streuwert 1.84, horizontal: 1.85, vertikal: 1.82

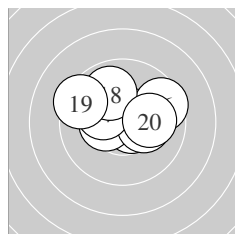

Serie 2:
 10.6 * 10.7 * 10.5 * 10.4 * 10.2 *
 9.6 → 10.2 * 9.9 ↘ 9.4 ↖ 10.1 →
 beste Teiler 68.5 (12.) 82.7 (11.) 106.0 (13.)
 Trefferlage 0.08 mm rechts, 0.66 mm hoch
 Streuwert 1.59, horizontal: 2.05, vertikal: 0.92

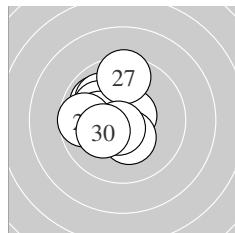

Serie 3:
 9.9 ↘ 10.7 * 10.0 ↖ 10.1 ↖ 10.2 *
 9.7 ← 9.5 ↑ 10.3 * 10.7 * 10.2 *
 beste Teiler 70.4 (22.) 75.5 (29.) 153.7 (28.)
 Trefferlage 1.16 mm links, 0.52 mm hoch
 Streuwert 1.39, horizontal: 1.29, vertikal: 1.48

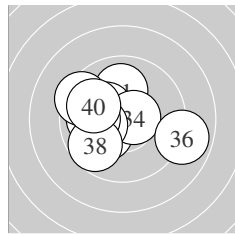

Serie 4:
 10.0 ↑ 10.3 * 10.2 * 10.6 * 10.2 *
 8.9 → 10.0 ← 9.7 ↙ 9.4 ↖ 9.9 ↖
 beste Teiler 92.9 (34.) 160.1 (32.) 185.0 (33.)
 Trefferlage 0.94 mm links, 0.08 mm hoch
 Streuwert 1.98, horizontal: 2.40, vertikal: 1.44

Unterschrift des Schuetzen

Meyton Elektronik

Ergebnis: **397.7** (380)
 Serien: 99.9 97.2 99.6 101.0
 Zaehler: 23 14 3 0 0 0 0 0 0 0
 Innenzehner: 16
 weiteste: 627 (17), 512 (7), 501 (15)
 beste Teiler 53.0 (19.) 60.0 (9.) 81.0 (35.)
 Trefferlage 0.17 mm rechts, 0.34 mm hoch
 Streuwert 2.01, horizontal: 1.94, vertikal: 2.08

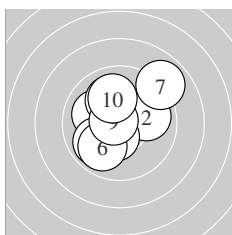
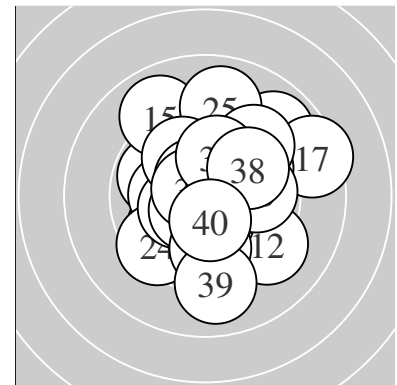

Serie 1:
 10.0 ↖ 9.9 → 10.2 * 10.4 * 9.9 ↙
 9.9 ↘ 8.9 ↗ 10.0 ↘ 10.7 * 10.0 ↗
 beste Teiler 60.0 (9.) 132.1 (4.) 198.6 (3.)
 Trefferlage 0.34 mm links, 0.30 mm hoch
 Streuwert 1.92, horizontal: 1.94, vertikal: 1.91

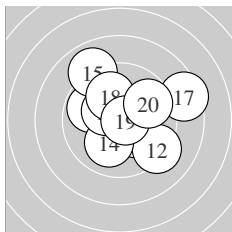

Serie 2:
 10.2 * 9.2 ↘ 9.8 ↖ 10.0 ↙ 8.9 ↘
 10.3 * 8.4 → 10.0 ↘ 10.7 * 9.7 ↗
 beste Teiler 53.0 (19.) 151.4 (16.) 181.5 (11.)
 Trefferlage 0.57 mm rechts, 0.62 mm hoch
 Streuwert 2.46, horizontal: 2.75, vertikal: 2.14

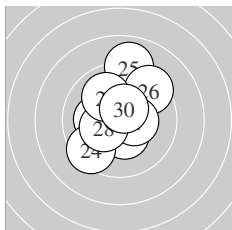

Serie 3:
 9.9 ↑ 10.2 * 10.4 * 9.5 ↙ 9.0 ↑
 9.4 ↗ 10.4 * 10.3 * 10.0 ↘ 10.5 *
 beste Teiler 112.3 (30.) 134.3 (27.) 141.0 (23.)
 Trefferlage 0.06 mm links, 0.85 mm hoch
 Streuwert 1.97, horizontal: 1.67, vertikal: 2.23

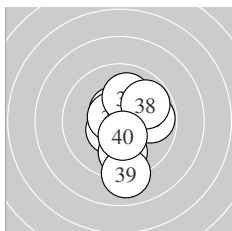

Serie 4:
 10.6 * 10.5 * 9.8 ↓ 10.5 * 10.6 *
 9.8 → 10.0 ↑ 9.8 ↗ 9.0 ↓ 10.4 *
 beste Teiler 81.0 (35.) 94.8 (31.) 107.1 (34.)
 Trefferlage 0.55 mm rechts, 0.38 mm tief
 Streuwert 1.73, horizontal: 1.22, vertikal: 2.12

Unterschrift des Schuetzen

Meyton Elektronik

Ergebnis: **405.0** (385)^{QF}
 Serien: 100.6 101.3 101.2 101.9
 Zaehler: 25 15 0 0 0 0 0 0 0 0
 Innenzehner: 23
 weiteste: 457 (1), 456 (28), 404 (11)
 beste Teiler 31.9 (10.) 33.7 (38.) 49.3 (7.)
 Trefferlage 0.77 mm links, 0.71 mm hoch
 Streuwert 1.53, horizontal: 1.63, vertikal: 1.41

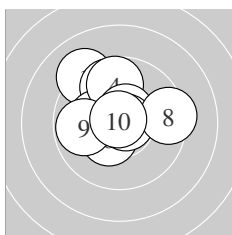
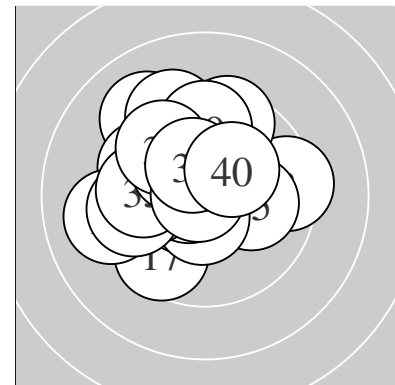

Serie 1:
 9.1 ↘ 9.8 ↗ 10.2 * 9.7 ↑ 10.6 *
 10.4 * 10.8 * 9.4 → 9.8 ← 10.8 *
 beste Teiler 31.9 (10.) 49.3 (7.) 97.6 (5.)
 Trefferlage 0.47 mm links, 1.02 mm hoch
 Streuwert 1.77, horizontal: 1.93, vertikal: 1.59

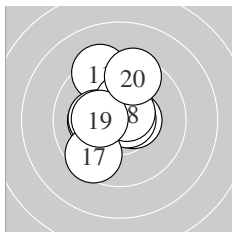

Serie 2:
 9.3 ↗ 10.5 * 10.2 * 10.2 * 10.4 *
 10.7 * 9.6 ↙ 10.6 * 10.3 * 9.5 ↑
 beste Teiler 63.2 (16.) 79.9 (18.) 110.0 (12.)
 Trefferlage 0.52 mm links, 0.67 mm hoch
 Streuwert 1.62, horizontal: 1.34, vertikal: 1.86

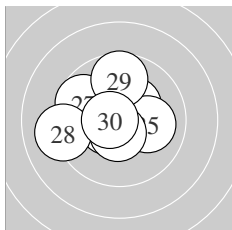

Serie 3:
 10.1 ↘ 10.3 * 10.6 * 10.5 * 10.1 →
 10.5 * 9.7 ↘ 9.1 ← 9.7 ↑ 10.6 *
 beste Teiler 76.8 (23.) 77.0 (30.) 102.9 (26.)
 Trefferlage 0.81 mm links, 0.47 mm hoch
 Streuwert 1.63, horizontal: 1.89, vertikal: 1.32

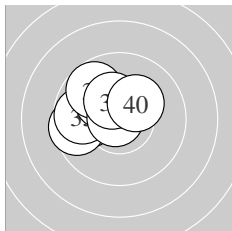

Serie 4:
 9.9 ← 10.7 * 10.7 * 9.6 ← 9.8 ←
 10.2 * 9.7 ↘ 10.8 * 10.3 * 10.2 *
 beste Teiler 33.7 (38.) 66.5 (32.) 70.1 (33.)
 Trefferlage 1.28 mm links, 0.69 mm hoch
 Streuwert 1.18, horizontal: 1.42, vertikal: 0.88

QF – Schütze hat sich fürs Finale qualifiziert

Unterschrift des Schuetzen

Meyton Elektronik

Ergebnis: **394.8** (374)
 Serien: 102.2 97.9 94.8 99.9
 Zaehler: 18 18 4 0 0 0 0 0 0 0
 Innenzehner: 14
 weiteste: 687 (26), 526 (21), 517 (20)
 beste Teiler 15.6 (5.) 18.3 (35.) 33.0 (3.)
 Trefferlage 0.54 mm rechts, 0.61 mm hoch
 Streuwert 2.19, horizontal: 2.77, vertikal: 1.40

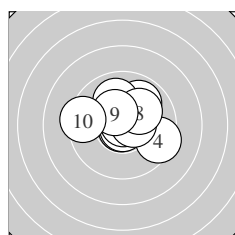
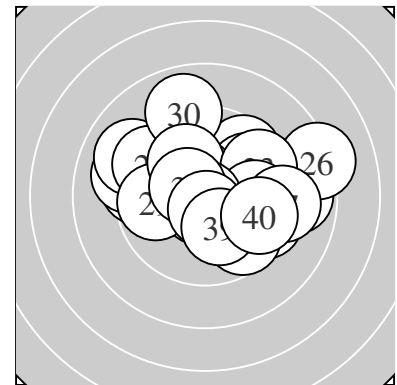

Serie 1:
 10.8 * 9.9 ↗ 10.8 * 9.4 ↘ 10.9 *
 10.0 ↑ 10.5 * 10.1 ↗ 10.4 * 9.4 ←
 beste Teiler 15.6 (5.) 33.0 (3.) 38.0 (1.)
 Trefferlage 0.23 mm rechts, 0.57 mm hoch
 Streuwert 1.61, horizontal: 1.94, vertikal: 1.19

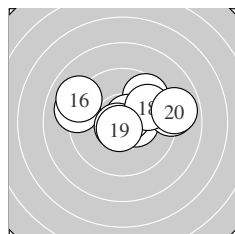

Serie 2:
 9.6 ↗ 10.4 * 9.1 ↖ 10.7 * 9.0 →
 9.0 ↖ 10.7 * 9.8 ↗ 10.7 * 8.9 →
 beste Teiler 65.0 (17.) 67.9 (14.) 69.7 (19.)
 Trefferlage 0.67 mm rechts, 0.86 mm hoch
 Streuwert 2.41, horizontal: 3.24, vertikal: 1.06

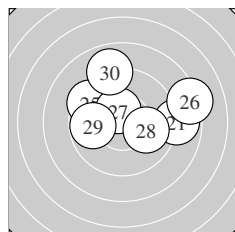

Serie 3:
 8.8 → 9.7 ↖ 9.9 ↖ 9.5 ↖ 9.5 ↖
 8.2 → 10.5 * 10.0 → 9.8 ← 8.9 ↑
 beste Teiler 119.9 (27.) 241.5 (28.) 272.9 (23.)
 Trefferlage 0.20 mm links, 1.31 mm hoch
 Streuwert 2.82, horizontal: 3.64, vertikal: 1.60

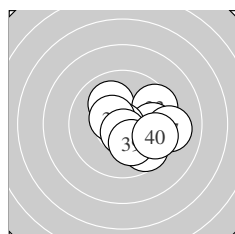

Serie 4:
 10.0 ↖ 9.7 ↘ 9.5 ↗ 9.8 → 10.9 *
 10.5 * 9.1 → 10.6 * 10.2 * 9.6 ↘
 beste Teiler 18.3 (35.) 78.3 (38.) 117.2 (36.)
 Trefferlage 1.46 mm rechts, 0.27 mm tief
 Streuwert 1.71, horizontal: 1.99, vertikal: 1.38

Unterschrift des Schuetzen

Meyton Elektronik

LG 40 ZR – Wertung – Frauen

StartNr: 70

StandNr: 122

12. Maerz 2017 14:01

Gufler,, Chiara #70233011

SG_Thaur

Ergebnis: **0.0** (0)_{DNS}

Serien:

Zaehler: 0 0 0 0 0 0 0 0 0 0

Innenzehner: 0

weiteste:

~~beste Teiler~~ – Schütze ist nicht zum Wettkampf angetreten

Trefferlage 0.00 mm , 0.00 mm

Streuwert

Unterschrift des Schuetzen

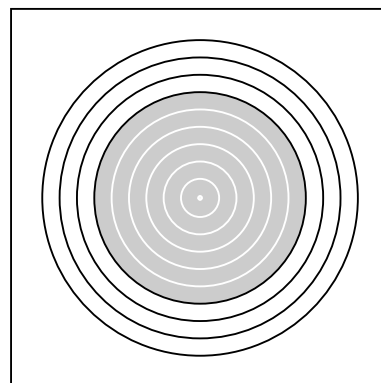

Ergebnis: **387.8** (369)
 Serien: 92.9 98.3 97.4 99.2
 Zaehler: 17 17 5 0 1 0 0 0 0 0
 Innenzehner: 14
 weiteste: 1017 (7), 713 (1), 709 (15)
 beste Teiler 11.1 (12.) 50.4 (26.) 71.5 (32.)
 Trefferlage 0.83 mm links, 1.37 mm hoch
 Streuwert 2.47, horizontal: 2.61, vertikal: 2.32

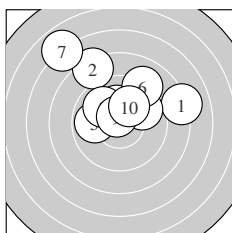
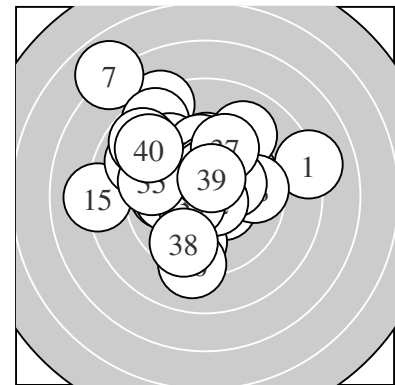

Serie 1:
 8.1 → 8.3 ↘ 10.2 * 9.8 ↗ 9.9 ←
 9.1 ↗ 6.9 ↘ 9.9 ↘ 10.6 * 10.1 ↗
 beste Teiler 78.0 (9.) 195.6 (3.) 213.1 (10.)
 Trefferlage 0.15 mm links, 2.79 mm hoch
 Streuwert 3.11, horizontal: 3.64, vertikal: 2.48

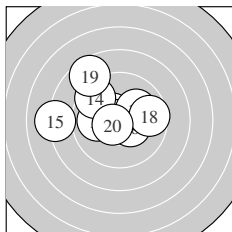

Serie 2:
 10.5 * 10.9 * 10.0 ← 9.5 ↘ 8.1 ←
 10.4 * 10.1 ↗ 9.6 → 8.6 ↘ 10.6 *
 beste Teiler 11.1 (12.) 92.6 (20.) 109.7 (11.)
 Trefferlage 1.09 mm links, 0.83 mm hoch
 Streuwert 2.41, horizontal: 2.96, vertikal: 1.68

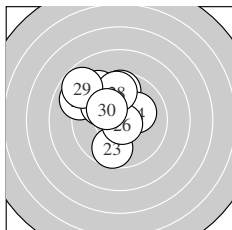

Serie 3:
 9.4 ↘ 9.7 ↑ 9.7 ↓ 10.2 * 9.0 ↘
 10.8 * 9.9 ↘ 9.7 ↑ 8.8 ↘ 10.2 *
 beste Teiler 50.4 (26.) 185.0 (30.) 199.6 (24.)
 Trefferlage 1.32 mm links, 1.55 mm hoch
 Streuwert 2.01, horizontal: 1.95, vertikal: 2.06

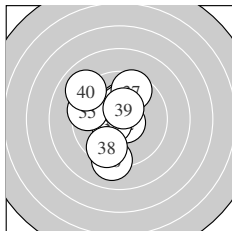

Serie 4:
 10.3 * 10.7 * 10.5 * 10.4 * 9.5 ←
 9.1 ↓ 9.6 ↑ 9.6 ↓ 10.5 * 9.0 ↘
 beste Teiler 71.5 (32.) 102.0 (33.) 124.3 (39.)
 Trefferlage 0.79 mm links, 0.31 mm hoch
 Streuwert 2.13, horizontal: 1.69, vertikal: 2.50

Unterschrift des Schuetzen

Meyton Elektronik

Ergebnis: **401.1** (380)
 Serien: 102.3 101.1 99.3 98.4
 Zaehler: 22 16 2 0 0 0 0 0 0 0
 Innenzehner: 16
 weiteste: 574 (20), 504 (29), 411 (26)
 beste Teiler 5.0 (15.) 33.0 (8.) 41.1 (22.)
 Trefferlage 0.09 mm rechts, 0.05 mm tief
 Streuwert 1.90, horizontal: 2.20, vertikal: 1.54

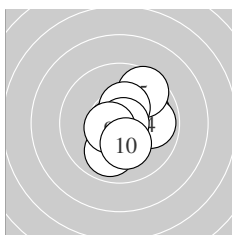
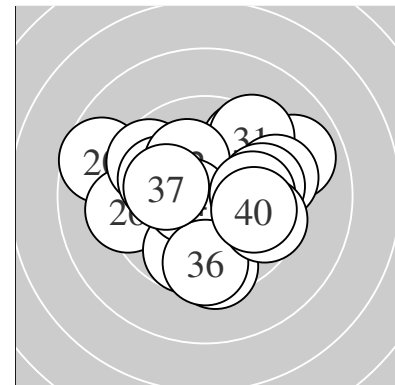

Serie 1:
 10.7 * 10.0 → 10.2 * 9.9 → 9.6 ↗
 10.4 * 9.9 ↓ 10.8 * 10.6 * 10.2 *
 beste Teiler 33.0 (8.) 68.9 (1.) 95.3 (9.)
 Trefferlage 0.56 mm rechts, 0.17 mm tief
 Streuwert 1.45, horizontal: 1.32, vertikal: 1.56

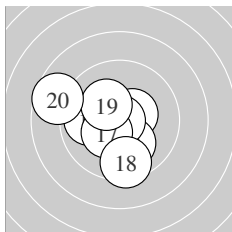

Serie 2:
 10.5 * 10.1 ↓ 10.6 * 10.4 * 10.9 *
 9.9 ← 10.3 * 9.5 ↓ 10.2 * 8.7 ↖
 beste Teiler 5.0 (15.) 88.0 (13.) 123.0 (11.)
 Trefferlage 1.00 mm links, 0.29 mm tief
 Streuwert 1.79, horizontal: 1.95, vertikal: 1.62

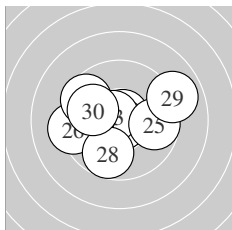

Serie 3:
 10.7 * 10.8 * 10.7 * 9.9 ← 9.7 →
 9.3 ← 9.6 ↖ 9.7 ↓ 8.9 → 10.0 ↖
 beste Teiler 41.1 (22.) 51.8 (21.) 67.7 (23.)
 Trefferlage 0.54 mm links, 0.14 mm hoch
 Streuwert 2.16, horizontal: 2.72, vertikal: 1.38

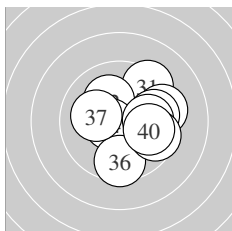

Serie 4:
 9.4 ↗ 10.1 ↖ 9.4 → 10.6 * 9.7 →
 9.6 ↓ 10.1 ← 10.0 → 9.6 ↘ 9.9 →
 beste Teiler 89.1 (34.) 202.1 (32.) 209.3 (37.)
 Trefferlage 1.35 mm rechts, 0.11 mm hoch
 Streuwert 1.93, horizontal: 2.08, vertikal: 1.77

Unterschrift des Schuetzen

Meyton Elektronik

LG 40 ZR – Wertung – Frauen

StandNr: 125

Klingler,, Lea #70410003

StartNr: 73

12. Maerz 2017 13:45

SG_Kramsach

Ergebnis: **0.0** (0)_{DNS}
Serien:
Zaehler: 0 0 0 0 0 0 0 0 0 0
Innenzehner: 0
weiteste:
~~beste Teiler~~ – Schütze ist nicht zum Wettkampf angetreten
Trefferlage 0.00 mm , 0.00 mm
Streuwert
Unterschrift des Schuetzen

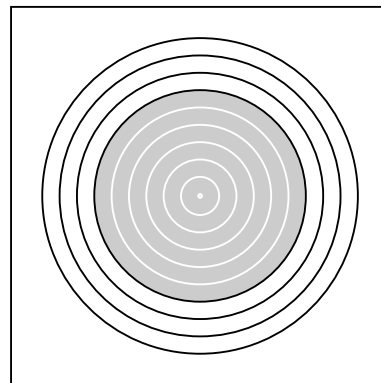

Meyton Elektronik

Ergebnis: **387.4** (368)
 Serien: 95.8 97.5 96.2 97.9
 Zaehler: 15 19 5 1 0 0 0 0 0 0
 Innenzehner: 11
 weiteste: 818 (4), 650 (1), 635 (16)
 beste Teiler 90.7 (13.) 95.1 (8.) 105.0 (35.)
 Trefferlage 0.66 mm links, 0.38 mm hoch
 Streuwert 2.49, horizontal: 2.91, vertikal: 2.00

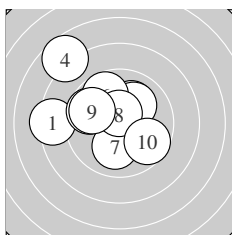
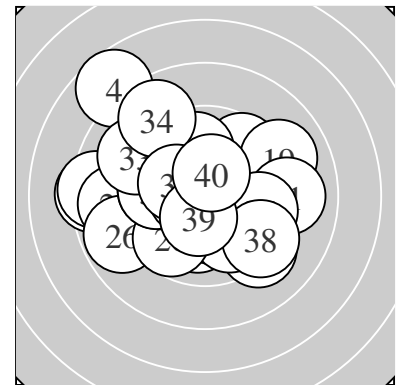

Serie 1:
 8.4 ← 9.7 ↖ 10.1 ↗ 7.7 ↘ 10.1 ↗
 9.7 ↘ 10.0 ↓ 10.6 * 9.8 ↖ 9.7 ↘
 beste Teiler 95.1 (8.) 219.3 (3.) 219.4 (5.)
 Trefferlage 1.40 mm links, 1.20 mm hoch
 Streuwert 2.68, horizontal: 2.95, vertikal: 2.37

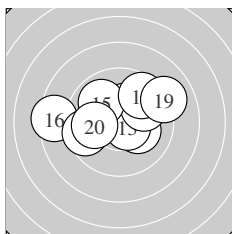

Serie 2:
 10.2 * 10.3 * 10.6 * 9.9 ↗ 9.9 ↘
 8.4 ← 9.6 ← 9.6 ↗ 9.0 ↗ 10.0 ←
 beste Teiler 90.7 (13.) 163.8 (12.) 194.2 (11.)
 Trefferlage 0.20 mm links, 0.73 mm hoch
 Streuwert 2.45, horizontal: 3.20, vertikal: 1.34

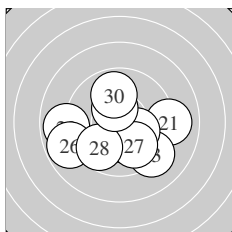

Serie 3:
 9.0 → 8.9 ← 9.2 ↘ 10.2 * 10.2 *
 8.8 ← 9.9 ↘ 9.7 ↗ 10.4 * 9.9 ↑
 beste Teiler 142.0 (29.) 179.0 (24.) 187.4 (25.)
 Trefferlage 0.15 mm links, 0.90 mm tief
 Streuwert 2.59, horizontal: 3.18, vertikal: 1.82

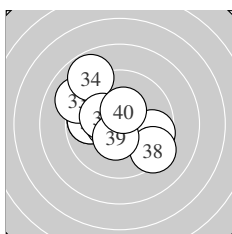

Serie 4:
 9.8 ← 9.8 ← 9.1 ↖ 8.8 ↘ 10.5 *
 10.2 * 9.6 → 9.3 ↘ 10.4 * 10.4 *
 beste Teiler 105.0 (35.) 130.6 (39.) 138.7 (40.)
 Trefferlage 0.88 mm links, 0.49 mm hoch
 Streuwert 2.25, horizontal: 2.51, vertikal: 1.95

Unterschrift des Schuetzen

Meyton Elektronik