

Ergebnis: **410.1** (389)
 Serien: 102.9 102.4 102.4 102.4
 Zähler: 29 11 0 0 0 0 0 0 0 0
 Innenzehner: 26
 weiteste: 432 (32), 366 (25), 361 (13)
 beste Teiler 11.1 (24.) 13.0 (12.) 40.8 (27.)
 Trefferlage 0.20 mm rechts, 0.33 mm hoch
 Streuwert 1.43, horizontal: 1.52, vertikal: 1.33

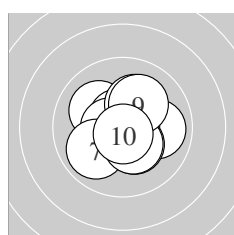

Serie 1:
 10.1 ↘ 9.9 → 10.7 * 10.6 * 10.3 *
 10.2 * 9.9 ↙ 10.4 * 10.1 ↗ 10.7 *
 beste Teiler 51.1 (10.) 71.5 (3.) 93.0 (4.)
 Trefferlage 0.12 mm rechts, 0.04 mm hoch
 Streuwert 1.33, horizontal: 1.41, vertikal: 1.25

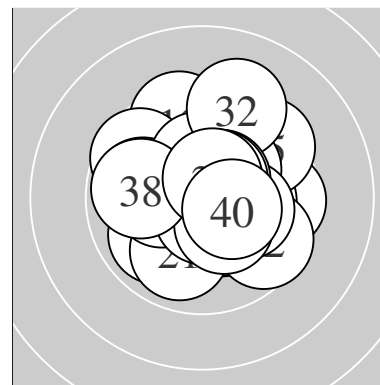
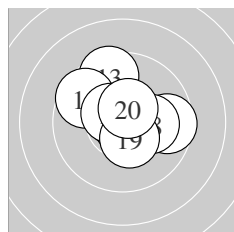

Serie 2:
 10.6 * 10.9 * 9.5 ↑ 10.7 * 9.6 ↘
 10.5 * 9.6 → 10.1 → 10.4 * 10.5 *
 beste Teiler 13.0 (12.) 68.8 (14.) 99.9 (11.)
 Trefferlage 0.07 mm rechts, 0.67 mm hoch
 Streuwert 1.50, horizontal: 1.69, vertikal: 1.28

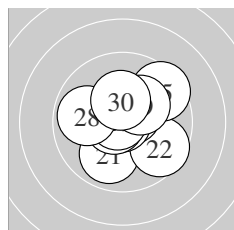

Serie 3:
 9.9 ↙ 9.6 ↘ 10.6 * 10.9 * 9.5 ↗
 10.7 * 10.8 * 9.9 ← 10.2 * 10.3 *
 beste Teiler 11.1 (24.) 40.8 (27.) 66.2 (26.)
 Trefferlage 0.26 mm rechts, 0.20 mm hoch
 Streuwert 1.58, horizontal: 1.70, vertikal: 1.45

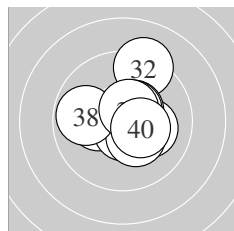

Serie 4:
 10.2 * 9.2 ↑ 10.5 * 10.2 * 10.7 *
 10.5 * 10.3 * 9.8 ← 10.6 * 10.4 *
 beste Teiler 75.4 (35.) 100.6 (39.) 109.8 (36.)
 Trefferlage 0.33 mm rechts, 0.40 mm hoch
 Streuwert 1.48, horizontal: 1.50, vertikal: 1.47

Unterschrift des Schützen

Meyton Elektronik

Ergebnis: **398.2** (381)
 Serien: 97.6 101.5 99.5 99.6
 Zähler: 21 19 0 0 0 0 0 0 0 0
 Innenzehner: 17
 weiteste: 491 (33), 462 (9), 435 (3)
 beste Teiler 48.7 (19.) 73.4 (13.) 87.9 (23.)
 Trefferlage 0.00 mm , 0.31 mm tief
 Streuwert 1.99, horizontal: 2.15, vertikal: 1.81

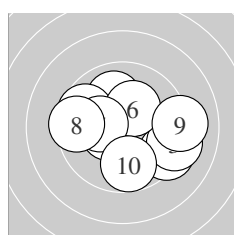
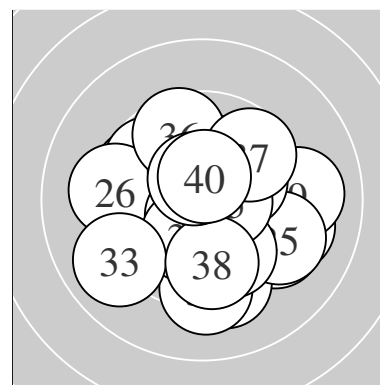

Serie 1:
 10.0 ↗ 9.3 ↘ 9.2 ↘ 10.5 * 9.7 ↖
 10.3 * 10.2 * 9.5 ← 9.1 → 9.8 ↓
 beste Teiler 119.4 (4.) 170.9 (6.) 181.8 (7.)
 Trefferlage 0.33 mm rechts, 0.08 mm tief
 Streuwert 2.38, horizontal: 2.96, vertikal: 1.62

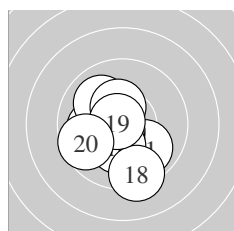

Serie 2:
 9.9 ↘ 10.1 ← 10.7 * 10.5 * 10.0 ↖
 10.2 * 10.4 * 9.3 ↓ 10.8 * 9.6 ↖
 beste Teiler 48.7 (19.) 73.4 (13.) 120.5 (14.)
 Trefferlage 0.61 mm links, 0.77 mm tief
 Streuwert 1.55, horizontal: 1.42, vertikal: 1.66

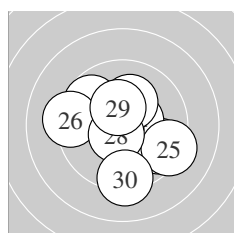

Serie 3:
 9.7 ↖ 9.6 ↘ 10.6 * 10.5 * 9.3 ↘
 9.3 ← 10.2 * 10.6 * 10.4 * 9.3 ↓
 beste Teiler 87.9 (23.) 90.6 (28.) 111.3 (24.)
 Trefferlage 0.17 mm rechts, 0.23 mm tief
 Streuwert 2.13, horizontal: 2.32, vertikal: 1.92

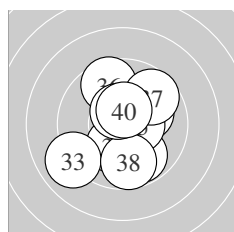

Serie 4:
 10.2 * 10.1 ↗ 9.0 ↖ 9.8 ↓ 10.5 *
 9.6 ↗ 9.7 ↗ 9.7 ↓ 10.5 * 10.5 *
 beste Teiler 108.8 (39.) 113.5 (40.) 115.3 (35.)
 Trefferlage 0.11 mm rechts, 0.18 mm tief
 Streuwert 2.03, horizontal: 1.82, vertikal: 2.21

Unterschrift des Schützen

Meyton Elektronik

Ergebnis:	409.8	(392)
Serien:	102.1	103.5 102.6 101.6
Zähler:	32	8 0 0 0 0 0 0 0 0
Innenzehner:	29	
weiteste:	396	(25), 375 (19), 365 (34)
beste Teiler	45.1	(21.) 56.0 (18.) 70.0 (9.)
Trefferlage	0.19 mm	rechts, 0.08 mm hoch
Streuwert	1.42,	horizontal: 1.63, vertikal: 1.17

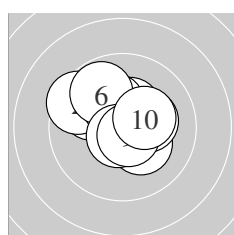
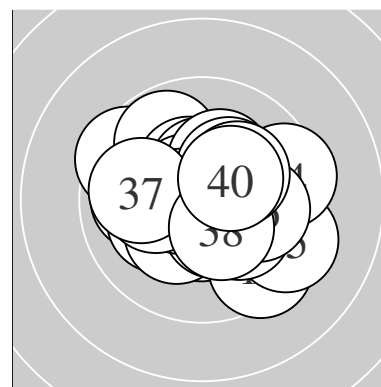

Serie 1:	9.9 ↘	9.5 ↘	10.4 *	10.3 *	10.3 *
	9.8 ↘	10.7 *	10.2 *	10.7 *	10.3 *
beste Teiler	70.0	(9.) 71.5 (7.)	140.0 (3.)		
Trefferlage	0.23 mm	links, 0.71 mm	hoch		
Streuwert	1.44,	horizontal: 1.66,	vertikal: 1.18		

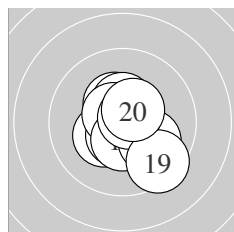

Serie 2:	10.4 *	10.4 *	10.3 *	10.6 *	10.6 *
	10.5 *	10.0 ↘	10.7 *	9.5 ↘	10.5 *
beste Teiler	56.0	(18.) 86.4 (15.)	100.8 (14.)		
Trefferlage	0.26 mm	rechts, 0.28 mm	tief		
Streuwert	1.27,	horizontal: 1.18,	vertikal: 1.36		

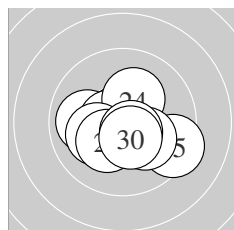

Serie 3:	10.8 *	9.9 ←	10.6 *	10.2 *	9.4 ↘
	10.1 ←	10.3 *	10.2 *	10.6 *	10.5 *
beste Teiler	45.1	(21.) 88.0 (23.)	92.9 (29.)		
Trefferlage	0.05 mm	rechts, 0.47 mm	tief		
Streuwert	1.44,	horizontal: 1.77,	vertikal: 1.00		

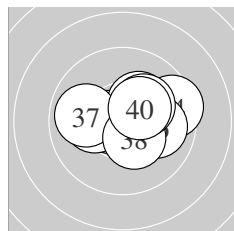

Serie 4:	10.2 *	10.6 *	10.2 *	9.5 →	10.3 *
	10.0 →	9.9 ←	10.4 *	10.2 *	10.3 *
beste Teiler	91.1	(32.) 144.2 (38.)	152.8 (40.)		
Trefferlage	0.68 mm	rechts, 0.40 mm	hoch		
Streuwert	1.48,	horizontal: 1.93,	vertikal: 0.80		

Unterschrift des Schützen

Meyton Elektronik

Ergebnis: **405.9** (389)
 Serien: 100.5 101.8 103.5 100.1
 Zähler: 29 11 0 0 0 0 0 0 0 0
 Innenzehner: 24
 weiteste: 438 (5), 410 (40), 408 (8)
 beste Teiler 20.8 (10.) 59.0 (7.) 83.8 (22.)
 Trefferlage 0.07 mm rechts, 0.22 mm hoch
 Streuwert 1.60, horizontal: 1.73, vertikal: 1.47

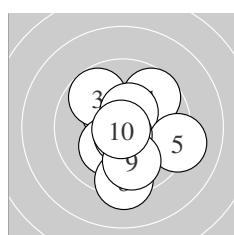
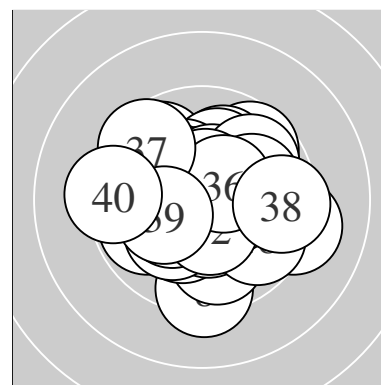

Serie 1:
 9.7 ↗ 10.3 * 9.8 ↘ 10.5 * 9.2 →
 10.2 * 10.7 * 9.3 ↓ 9.9 ↓ 10.9 *
 beste Teiler 20.8 (10.) 59.0 (7.) 125.0 (4.)
 Trefferlage 0.36 mm rechts, 0.31 mm tief
 Streuwert 1.94, horizontal: 1.76, vertikal: 2.10

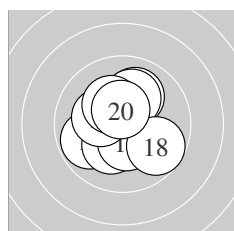

Serie 2:
 9.8 ↙ 10.0 ↗ 10.5 * 10.1 ↗ 10.2 *
 10.4 * 10.3 * 9.7 ↘ 10.3 * 10.5 *
 beste Teiler 113.0 (20.) 115.2 (13.) 137.3 (16.)
 Trefferlage 0.24 mm links, 0.22 mm hoch
 Streuwert 1.49, horizontal: 1.45, vertikal: 1.52

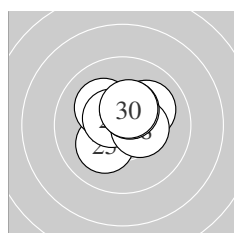

Serie 3:
 10.5 * 10.6 * 10.1 ↗ 10.1 ↗ 10.2 *
 10.2 * 10.6 * 10.4 * 10.4 * 10.4 *
 beste Teiler 83.8 (22.) 99.3 (27.) 103.2 (21.)
 Trefferlage 0.20 mm rechts, 0.60 mm hoch
 Streuwert 1.08, horizontal: 1.25, vertikal: 0.89

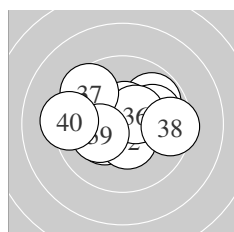

Serie 4:
 10.3 * 10.4 * 9.8 ↗ 10.5 * 10.0 →
 10.5 * 9.6 ↘ 9.5 → 10.2 * 9.3 ←
 beste Teiler 104.0 (34.) 123.6 (36.) 126.5 (32.)
 Trefferlage 0.00 mm , 0.39 mm hoch
 Streuwert 1.91, horizontal: 2.43, vertikal: 1.16

Unterschrift des Schützen

Meyton Elektronik

Ergebnis: **397.1** (380)
 Serien: 97.2 101.3 98.4 100.2
 Zähler: 23 14 3 0 0 0 0 0 0 0
 Innenzehner: 18
 weiteste: 638 (1), 600 (25), 521 (27)
 beste Teiler 28.0 (38.) 61.0 (24.) 63.1 (29.)
 Trefferlage 0.14 mm rechts, 0.70 mm hoch
 Streuwert 2.06, horizontal: 2.50, vertikal: 1.50

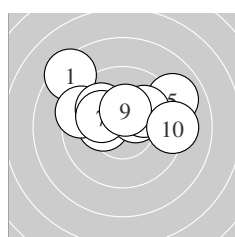
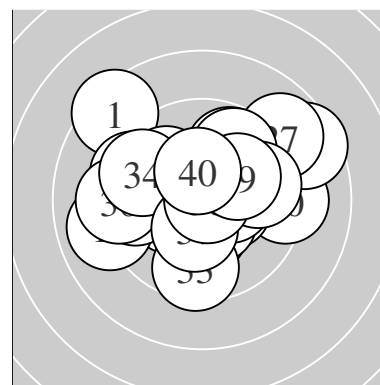

Serie 1:
 8.4 ↘ 10.3 * 10.4 * 9.4 ↘ 9.0 ↗
 10.0 ↘ 10.1 ↘ 10.0 ↗ 10.4 * 9.2 →
 beste Teiler 143.6 (3.) 148.9 (9.) 167.9 (2.)
 Trefferlage 0.15 mm links, 1.46 mm hoch
 Streuwert 2.35, horizontal: 3.06, vertikal: 1.28

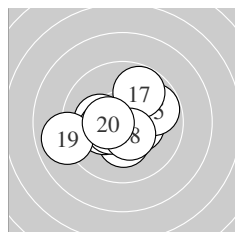

Serie 2:
 10.2 * 10.3 * 10.4 * 10.3 * 9.8 ↗
 10.5 * 9.8 ↗ 10.5 * 9.0 ← 10.5 *
 beste Teiler 110.9 (16.) 120.5 (18.) 124.1 (20.)
 Trefferlage 0.44 mm links, 0.17 mm tief
 Streuwert 1.75, horizontal: 2.14, vertikal: 1.25

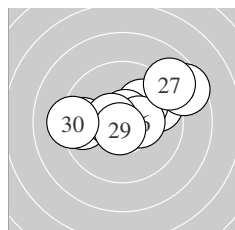

Serie 3:
 9.6 ↗ 9.6 ← 10.1 ↗ 10.7 * 8.6 ↗
 10.4 * 8.9 ↗ 10.6 * 10.7 * 9.2 ←
 beste Teiler 61.0 (24.) 63.1 (29.) 98.9 (28.)
 Trefferlage 0.66 mm rechts, 0.90 mm hoch
 Streuwert 2.36, horizontal: 3.08, vertikal: 1.31

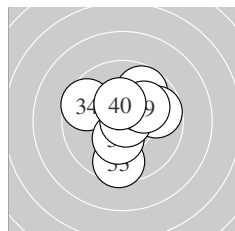

Serie 4:
 9.9 ↗ 10.2 * 9.5 ↓ 9.6 ↘ 9.8 ↗
 9.7 → 10.3 * 10.8 * 10.1 ↗ 10.3 *
 beste Teiler 28.0 (38.) 151.7 (40.) 152.8 (37.)
 Trefferlage 0.49 mm rechts, 0.61 mm hoch
 Streuwert 1.75, horizontal: 1.66, vertikal: 1.84

Unterschrift des Schützen

Meyton Elektronik

Ergebnis: **411.1** (392)
 Serien: 100.6 103.3 103.1 104.1
 Zähler: 35 4 0 0 1 0 0 0 0 0
 Innenzehner: 34
 weiteste: 1017 (6), 403 (21), 368 (31)
 beste Teiler 1.4 (28.) 50.3 (11.) 54.1 (35.)
 Trefferlage 0.00 mm , 0.21 mm hoch
 Streuwert 1.65, horizontal: 1.38, vertikal: 1.89

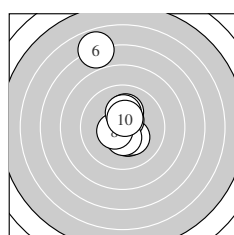
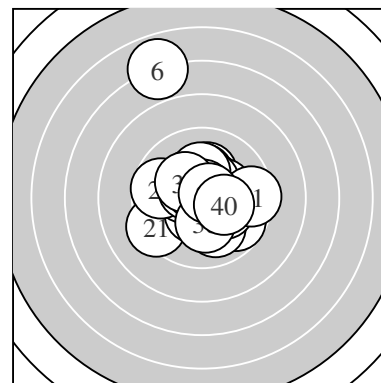

Serie 1:
 10.7 * 10.3 * 10.3 * 10.6 * 10.2 *
 6.9 ↗ 10.4 * 10.5 * 10.2 * 10.5 *
 beste Teiler 68.5 (1.) 92.5 (4.) 109.1 (8.)
 Trefferlage 0.08 mm links, 1.03 mm hoch
 Streuwert 2.48, horizontal: 1.25, vertikal: 3.27

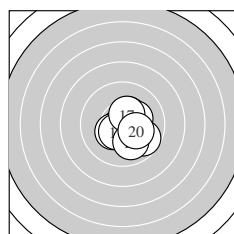

Serie 2:
 10.8 * 10.4 * 10.7 * 10.3 * 10.5 *
 10.3 * 10.4 * 9.7 ↘ 10.0 ↓ 10.2 *
 beste Teiler 50.3 (11.) 56.5 (13.) 120.2 (15.)
 Trefferlage 0.56 mm rechts, 0.43 mm tief
 Streuwert 1.16, horizontal: 1.16, vertikal: 1.16

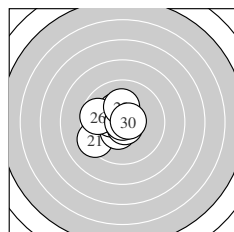

Serie 3:
 9.3 ↙ 10.4 * 10.5 * 10.3 * 10.4 *
 9.7 ← 10.7 * 10.9 * 10.2 * 10.7 *
 beste Teiler 1.4 (28.) 62.1 (27.) 72.1 (30.)
 Trefferlage 0.87 mm links, 0.16 mm hoch
 Streuwert 1.29, horizontal: 1.38, vertikal: 1.20

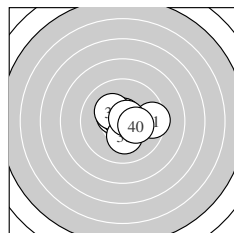

Serie 4:
 9.5 → 10.6 * 10.5 * 10.6 * 10.7 *
 10.7 * 10.3 * 10.2 * 10.7 * 10.3 *
 beste Teiler 54.1 (35.) 60.4 (39.) 62.2 (36.)
 Trefferlage 0.40 mm rechts, 0.12 mm hoch
 Streuwert 1.18, horizontal: 1.43, vertikal: 0.87

Unterschrift des Schützen

Meyton Elektronik

Ergebnis: **409.3** (391)
 Serien: 101.5 104.0 101.8 102.0
 Zähler: 31 9 0 0 0 0 0 0 0 0
 Innenzehner: 22
 weiteste: 415 (12), 366 (36), 364 (9)
 beste Teiler 32.2 (4.) 37.7 (33.) 47.0 (27.)
 Trefferlage 0.05 mm rechts, 0.20 mm hoch
 Streuwert 1.46, horizontal: 1.44, vertikal: 1.48

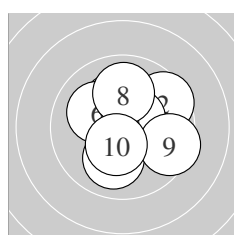
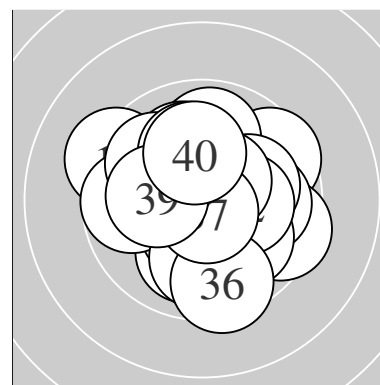

Serie 1:
 10.4 * 9.6 ↗ 10.2 * 10.8 * 10.5 *
 10.1 ↖ 10.0 ↓ 10.0 ↑ 9.5 ↘ 10.4 *
 beste Teiler 32.2 (4.) 105.9 (5.) 130.6 (1.)
 Trefferlage 0.41 mm rechts, 0.40 mm hoch
 Streuwert 1.60, horizontal: 1.63, vertikal: 1.56

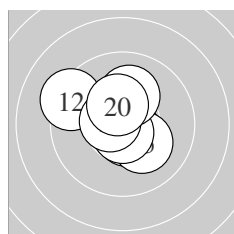

Serie 2:
 10.7 * 9.3 ↖ 10.7 * 10.6 * 10.2 *
 10.7 * 10.7 * 10.1 ↑ 10.6 * 10.4 *
 beste Teiler 53.5 (11.) 59.5 (13.) 61.0 (17.)
 Trefferlage 0.31 mm links, 0.30 mm hoch
 Streuwert 1.26, horizontal: 1.37, vertikal: 1.14

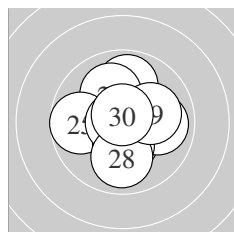

Serie 3:
 9.9 ↑ 10.4 * 9.9 → 10.1 ↖ 9.7 ←
 10.3 * 10.8 * 9.9 ↓ 10.1 → 10.7 *
 beste Teiler 47.0 (27.) 53.0 (30.) 144.5 (22.)
 Trefferlage 0.08 mm rechts, 0.00 mm
 Streuwert 1.57, horizontal: 1.53, vertikal: 1.61

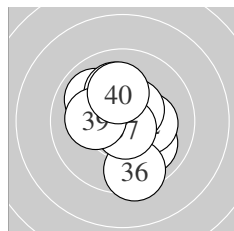

Serie 4:
 10.0 ↘ 10.2 * 10.8 * 9.9 ↖ 10.5 *
 9.5 ↓ 10.7 * 10.1 ↑ 10.2 * 10.1 ↑
 beste Teiler 37.7 (33.) 56.0 (37.) 114.5 (35.)
 Trefferlage 0.03 mm rechts, 0.11 mm hoch
 Streuwert 1.55, horizontal: 1.33, vertikal: 1.74

Unterschrift des Schützen

Meyton Elektronik

Ergebnis: **387.5** (370)
 Serien: 98.0 95.4 96.6 97.5
 Zähler: 15 20 5 0 0 0 0 0 0 0
 Innenzehner: 8
 weiteste: 703 (17), 678 (2), 673 (12)
 beste Teiler 64.3 (15.) 90.3 (5.) 102.1 (20.)
 Trefferlage 0.91 mm links, 0.42 mm hoch
 Streuwert 2.41, horizontal: 2.89, vertikal: 1.80

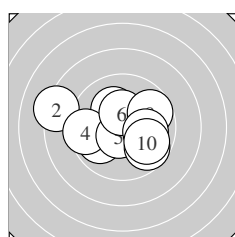
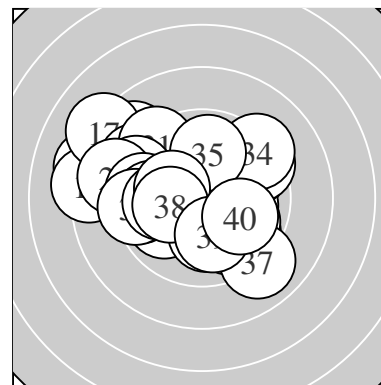

Serie 1:
 10.2 * 8.2 ↖ 9.9 ↙ 9.5 ← 10.6 *
 10.4 * 9.7 ↘ 9.7 ↗ 10.0 → 9.8 ↘
 beste Teiler 90.3 (5.) 143.2 (6.) 196.3 (1.)
 Trefferlage 0.40 mm links, 0.00 mm
 Streuwert 2.40, horizontal: 3.06, vertikal: 1.47

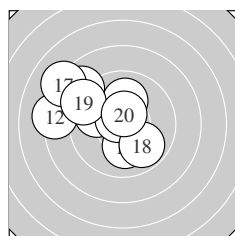

Serie 2:
 10.1 ↓ 8.3 ← 9.9 ↖ 10.0 ↑ 10.7 *
 8.8 ↘ 8.1 ↖ 9.8 ↘ 9.2 ↖ 10.5 *
 beste Teiler 64.3 (15.) 102.1 (20.) 214.3 (11.)
 Trefferlage 2.08 mm links, 1.09 mm hoch
 Streuwert 2.52, horizontal: 2.92, vertikal: 2.03

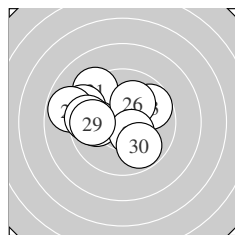

Serie 3:
 9.3 ↘ 9.3 ↖ 9.7 ↗ 8.8 ← 9.9 ←
 10.1 ↗ 10.4 * 9.5 ← 9.8 ← 9.8 ↘
 beste Teiler 133.2 (27.) 209.4 (26.) 255.4 (25.)
 Trefferlage 1.45 mm links, 0.61 mm hoch
 Streuwert 2.22, horizontal: 2.72, vertikal: 1.56

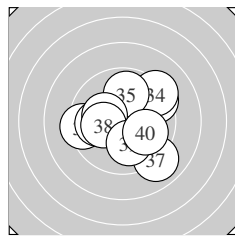

Serie 4:
 9.4 ← 9.4 ↗ 10.0 ← 9.3 ↗ 9.9 ↑
 10.2 * 9.0 ↘ 10.2 * 10.1 ↓ 10.0 ↘
 beste Teiler 186.3 (36.) 192.2 (38.) 225.0 (39.)
 Trefferlage 0.29 mm rechts, 0.01 mm tief
 Streuwert 2.40, horizontal: 2.68, vertikal: 2.08

Unterschrift des Schützen

Meyton Elektronik

Ergebnis:	395.6	(376)
Serien:	97.2	99.0 97.8 101.6
Zähler:	19 18 3	0 0 0 0 0 0 0
Innenzehner:	16	
weiteste:	591 (16), 580 (1), 543 (28)	
beste Teiler	22.6 (13.)	33.8 (23.) 34.9 (2.)
Trefferlage	0.40 mm rechts,	0.26 mm hoch
Streuwert	2.13, horizontal:	2.19, vertikal: 2.07

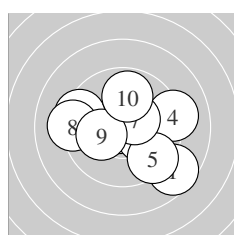
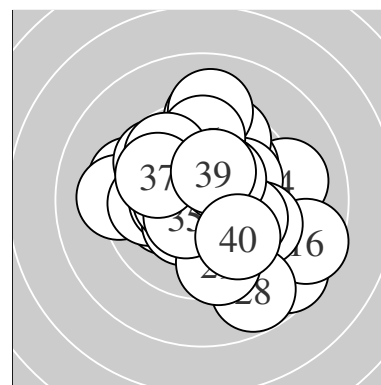

Serie 1:	8.6 ↘	10.8 *	10.2 *	9.1 →	9.4 ↘
	9.4 ←	10.4 *	9.2 ←	10.2 *	9.9 ↑
beste Teiler	34.9 (2.)	127.8 (7.)	191.8 (3.)		
Trefferlage	0.43 mm rechts,	0.23 mm tief			
Streuwert	2.56, horizontal:	3.09, vertikal: 1.88			

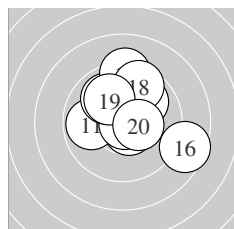

Serie 2:	9.9 ←	10.6 *	10.9 *	9.9 ↗	9.9 ↖
	8.6 →	9.2 ↑	9.6 ↑	10.0 ↘	10.4 *
beste Teiler	22.6 (13.)	88.7 (12.)	141.2 (20.)		
Trefferlage	0.56 mm rechts,	0.98 mm hoch			
Streuwert	2.12, horizontal:	2.25, vertikal: 1.99			

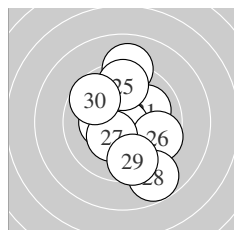

Serie 3:	10.0 ↗	10.3 *	10.8 *	9.1 ↑	9.6 ↑
	9.6 →	10.3 *	8.8 ↘	9.6 ↓	9.7 ↖
beste Teiler	33.8 (23.)	154.0 (27.)	162.0 (22.)		
Trefferlage	0.42 mm rechts,	0.01 mm hoch			
Streuwert	2.40, horizontal:	1.81, vertikal: 2.87			

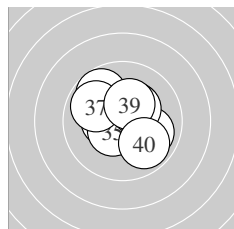

Serie 4:	10.3 *	9.7 ↖	10.3 *	10.4 *	10.5 *
	10.0 →	9.9 ↖	10.3 *	10.3 *	9.9 ↘
beste Teiler	119.5 (35.)	142.0 (34.)	154.3 (33.)		
Trefferlage	0.18 mm rechts,	0.29 mm hoch			
Streuwert	1.53, horizontal:	1.66, vertikal: 1.38			

Unterschrift des Schützen

Ergebnis: **392.7** (376)
 Serien: 98.3 101.1 97.0 96.3
 Zähler: 20 17 2 1 0 0 0 0 0 0
 Innenzehner: 15
 weiteste: 768 (29), 708 (23), 645 (34)
 beste Teiler 57.0 (13.) 72.6 (19.) 80.8 (27.)
 Trefferlage 0.29 mm rechts, 0.19 mm hoch
 Streuwert 2.35, horizontal: 2.56, vertikal: 2.12

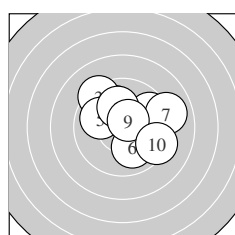
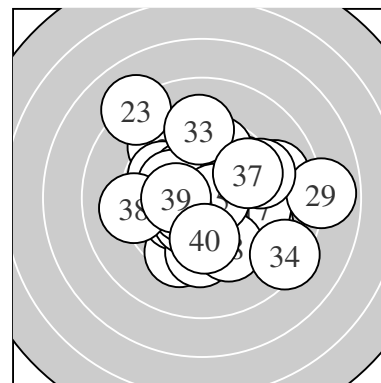

Serie 1:
 10.0 ↖ 9.7 ↗ 9.3 ↘ 10.4 * 9.9 ↙
 10.0 ↘ 9.0 → 10.1 ↑ 10.6 * 9.3 ↘
 beste Teiler 94.4 (9.) 147.1 (4.) 220.9 (8.)
 Trefferlage 0.59 mm rechts, 0.97 mm hoch
 Streuwert 2.12, horizontal: 2.47, vertikal: 1.71

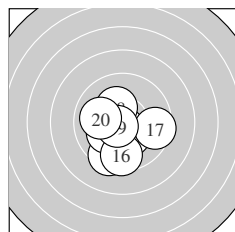

Serie 2:
 9.4 ↓ 10.3 * 10.7 * 10.5 * 10.2 *
 9.5 ↓ 9.5 → 10.3 * 10.7 * 10.0 ←
 beste Teiler 57.0 (13.) 72.6 (19.) 111.7 (14.)
 Trefferlage 0.33 mm links, 1.00 mm tief
 Streuwert 1.59, horizontal: 1.61, vertikal: 1.57

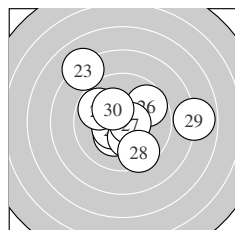

Serie 3:
 10.3 * 10.5 * 8.1 ↘ 9.8 ↙ 10.3 *
 9.7 ↗ 10.6 * 9.5 ↘ 7.9 → 10.3 *
 beste Teiler 80.8 (27.) 124.3 (22.) 167.8 (21.)
 Trefferlage 0.35 mm rechts, 0.35 mm hoch
 Streuwert 2.87, horizontal: 3.26, vertikal: 2.42

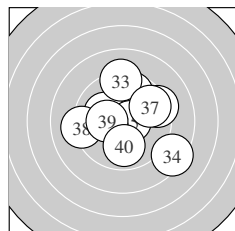

Serie 4:
 9.7 ↑ 10.1 ↙ 9.2 ↑ 8.4 ↘ 10.6 *
 9.3 → 9.6 → 9.2 ← 10.3 * 9.9 ↓
 beste Teiler 83.1 (35.) 168.0 (39.) 209.9 (32.)
 Trefferlage 0.58 mm rechts, 0.44 mm hoch
 Streuwert 2.67, horizontal: 2.89, vertikal: 2.42

Unterschrift des Schützen

Ergebnis: **383.2** (369)
 Serien: 96.3 94.0 95.8 97.1
 Zähler: 15 19 6 0 0 0 0 0 0 0
 Innenzehner: 6
 weiteste: 748 (32), 678 (28), 634 (20)
 beste Teiler 45.1 (37.) 98.2 (18.) 101.9 (23.)
 Trefferlage 1.09 mm links, 0.74 mm tief
 Streuwert 2.56, horizontal: 2.93, vertikal: 2.13

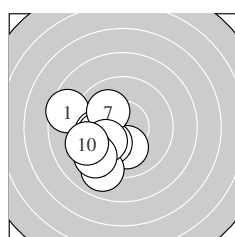
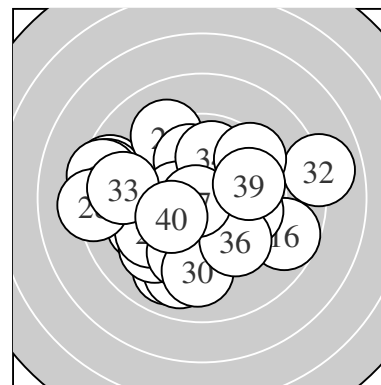

Serie 1:
 8.6 ↖ 10.1 ↓ 10.1 ↗ 9.0 ↓ 9.9 ←
 9.9 ← 10.1 ↘ 10.0 ↖ 9.3 ↗ 9.3 ←
 beste Teiler 206.2 (3.) 212.3 (2.) 222.2 (7.)
 Trefferlage 2.36 mm links, 1.21 mm tief
 Streuwert 1.76, horizontal: 1.62, vertikal: 1.88

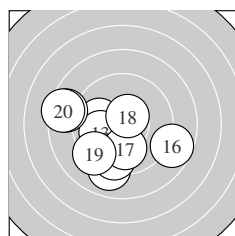

Serie 2:
 10.0 ↖ 9.0 ↓ 10.0 ← 9.5 ↓ 8.5 ←
 8.7 → 10.0 ↓ 10.6 * 9.3 ↗ 8.4 ←
 beste Teiler 98.2 (18.) 243.9 (13.) 246.1 (11.)
 Trefferlage 1.61 mm links, 1.26 mm tief
 Streuwert 2.79, horizontal: 3.27, vertikal: 2.21

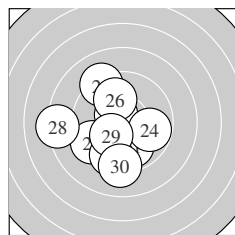

Serie 3:
 9.9 ↓ 9.4 ↖ 10.5 * 9.8 → 9.2 ↘
 10.0 ↑ 9.5 ↓ 8.2 ← 10.2 * 9.1 ↓
 beste Teiler 101.9 (23.) 180.0 (29.) 247.2 (26.)
 Trefferlage 1.24 mm links, 0.81 mm tief
 Streuwert 2.56, horizontal: 2.54, vertikal: 2.58

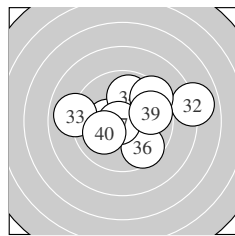

Serie 4:
 10.3 * 8.0 → 9.0 ← 9.9 ↑ 10.3 *
 9.6 ↘ 10.8 * 9.4 ↗ 9.7 → 10.1 ←
 beste Teiler 45.1 (37.) 154.0 (31.) 172.0 (35.)
 Trefferlage 0.85 mm rechts, 0.33 mm hoch
 Streuwert 2.63, horizontal: 3.34, vertikal: 1.65

Unterschrift des Schützen

Meyton Elektronik

Ergebnis: **397.0** (377)
 Serien: 95.3 101.2 102.4 98.1
 Zähler: 17 23 0 0 0 0 0 0 0 0
 Innenzehner: 14
 weiteste: 482 (4), 471 (2), 446 (8)
 beste Teiler 56.6 (15.) 77.1 (21.) 86.6 (17.)
 Trefferlage 0.29 mm links, 0.15 mm hoch
 Streuwert 2.00, horizontal: 2.20, vertikal: 1.78

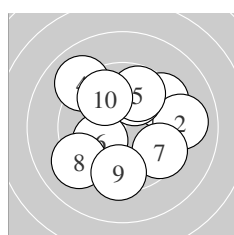
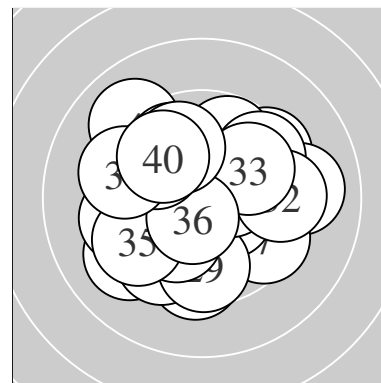

Serie 1:
 9.4 ↗ 9.1 → 9.9 ↗ 9.0 ↘ 9.8 ↗
 10.1 ↖ 9.5 ↘ 9.2 ↖ 9.5 ↓ 9.8 ↘
 beste Teiler 212.1 (6.) 256.4 (3.) 279.0 (10.)
 Trefferlage 0.26 mm rechts, 0.41 mm hoch
 Streuwert 2.70, horizontal: 2.81, vertikal: 2.59

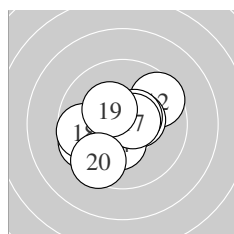

Serie 2:
 9.6 ↖ 9.6 ↗ 10.4 * 10.3 * 10.7 *
 10.5 * 10.6 * 9.7 ↖ 10.3 * 9.5 ↖
 beste Teiler 56.6 (15.) 86.6 (17.) 112.5 (16.)
 Trefferlage 0.31 mm links, 0.17 mm tief
 Streuwert 1.71, horizontal: 1.94, vertikal: 1.45

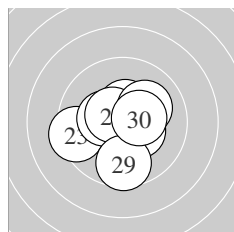

Serie 3:
 10.6 * 10.5 * 9.4 ↖ 10.5 * 10.4 *
 10.4 * 10.5 * 10.1 ↗ 9.6 ↓ 10.4 *
 beste Teiler 77.1 (21.) 101.0 (27.) 109.0 (22.)
 Trefferlage 0.12 mm links, 0.20 mm tief
 Streuwert 1.50, horizontal: 1.66, vertikal: 1.32

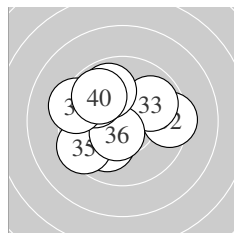

Serie 4:
 9.8 ↘ 9.4 → 9.9 ↗ 10.1 ↖ 9.5 ↖
 10.5 * 9.8 ↘ 9.4 ↖ 9.9 ↘ 9.8 ↘
 beste Teiler 107.3 (36.) 223.5 (34.) 266.9 (33.)
 Trefferlage 1.00 mm links, 0.56 mm hoch
 Streuwert 2.04, horizontal: 2.37, vertikal: 1.64

Unterschrift des Schützen

Meyton Elektronik

Ergebnis: **396.1** (377)
 Serien: 98.7 101.1 95.5 100.8
 Zähler: 23 13 3 0 1 0 0 0 0 0
 Innenzehner: 21
 weiteste: 1033 (25), 614 (4), 597 (28)
 beste Teiler 51.6 (31.) 63.9 (29.) 76.4 (20.)
 Trefferlage 0.08 mm rechts, 0.19 mm tief
 Streuwert 2.31, horizontal: 2.84, vertikal: 1.60

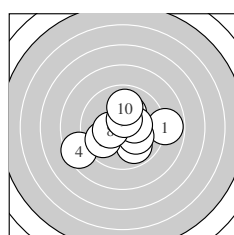
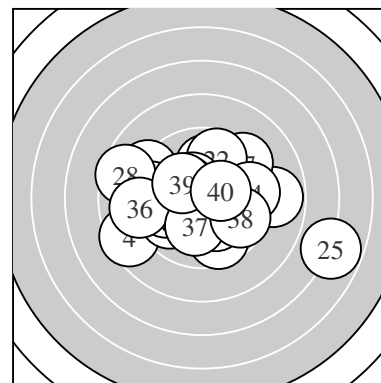

Serie 1:
 8.8 → 9.9 ↘ 10.2 * 8.5 ↙ 9.8 ↖
 10.2 * 10.4 * 10.3 * 10.6 * 10.0 ↑
 beste Teiler 99.2 (9.) 149.6 (7.) 155.0 (8.)
 Trefferlage 0.16 mm rechts, 0.25 mm tief
 Streuwert 2.35, horizontal: 2.85, vertikal: 1.72

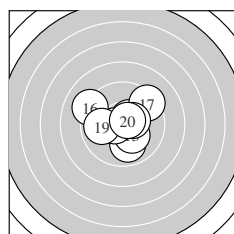

Serie 2:
 9.9 ↓ 10.6 * 10.2 * 10.5 * 10.6 *
 9.1 ↖ 9.3 ↗ 10.4 * 9.9 ← 10.6 *
 beste Teiler 76.4 (20.) 84.8 (12.) 100.2 (15.)
 Trefferlage 0.06 mm rechts, 0.17 mm hoch
 Streuwert 1.80, horizontal: 2.06, vertikal: 1.50

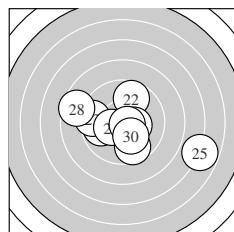

Serie 3:
 9.8 ← 9.7 ↑ 9.4 ← 10.4 * 6.8 →
 10.3 * 9.6 ↓ 8.6 ← 10.7 * 10.2 *
 beste Teiler 63.9 (29.) 146.9 (24.) 151.6 (26.)
 Trefferlage 0.14 mm rechts, 0.54 mm tief
 Streuwert 3.26, horizontal: 4.14, vertikal: 2.02

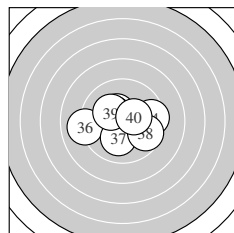

Serie 4:
 10.7 * 10.3 * 10.4 * 9.5 → 10.4 *
 9.1 ← 10.1 ↓ 9.7 ↘ 10.2 * 10.4 *
 beste Teiler 51.6 (31.) 135.6 (33.) 146.2 (35.)
 Trefferlage 0.04 mm links, 0.14 mm tief
 Streuwert 1.86, horizontal: 2.34, vertikal: 1.21

Unterschrift des Schützen

Meyton Elektronik

Ergebnis: **413.6** (397)
 Serien: 103.2 103.0 103.1 104.3
 Zähler: 37 3 0 0 0 0 0 0 0 0
 Innenzehner: 28
 weiteste: 334 (34), 292 (11), 258 (29)
 beste Teiler 10.0 (33.) 25.8 (20.) 32.4 (31.)
 Trefferlage 0.26 mm rechts, 0.09 mm tief
 Streuwert 1.21, horizontal: 1.43, vertikal: 0.94

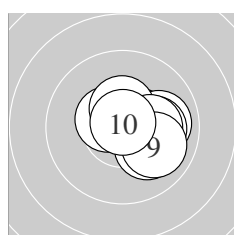
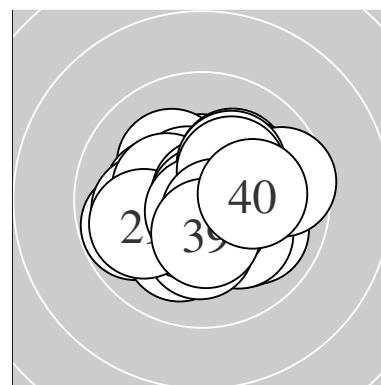

Serie 1:
 10.1 ↘ 10.5 * 10.6 * 10.5 * 10.0 →
 10.1 → 10.4 * 10.2 * 10.0 ↘ 10.8 *
 beste Teiler 33.0 (10.) 80.9 (3.) 114.5 (4.)
 Trefferlage 1.12 mm rechts, 0.03 mm hoch
 Streuwert 0.99, horizontal: 1.15, vertikal: 0.79

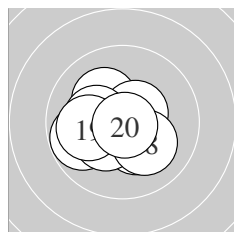

Serie 2:
 9.8 ← 10.7 * 10.2 * 10.3 * 10.5 *
 10.2 * 10.3 * 10.1 ↘ 10.0 ← 10.9 *
 beste Teiler 25.8 (20.) 65.2 (12.) 106.2 (15.)
 Trefferlage 0.61 mm links, 0.26 mm tief
 Streuwert 1.24, horizontal: 1.45, vertikal: 0.97

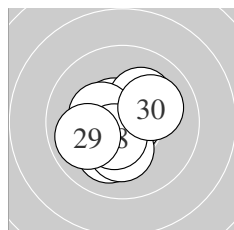

Serie 3:
 10.6 * 10.8 * 10.1 ↙ 10.4 * 10.2 *
 10.2 * 10.3 * 10.5 * 9.9 ← 10.1 →
 beste Teiler 44.0 (22.) 97.0 (21.) 114.6 (28.)
 Trefferlage 0.37 mm links, 0.23 mm tief
 Streuwert 1.24, horizontal: 1.30, vertikal: 1.19

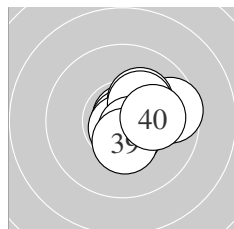

Serie 4:
 10.8 * 10.6 * 10.9 * 9.6 → 10.2 *
 10.8 * 10.3 * 10.6 * 10.4 * 10.1 →
 beste Teiler 10.0 (33.) 32.4 (31.) 47.0 (36.)
 Trefferlage 0.91 mm rechts, 0.05 mm hoch
 Streuwert 0.98, horizontal: 1.06, vertikal: 0.89

Unterschrift des Schützen

Meyton Elektronik

Ergebnis: **392.0** (378)
 Serien: 98.0 97.2 97.4 99.4
 Zähler: 20 18 2 0 0 0 0 0 0 0
 Innenzehner: 11
 weiteste: 652 (11), 622 (32), 482 (8)
 beste Teiler 75.0 (30.) 81.0 (33.) 97.6 (3.)
 Trefferlage 0.47 mm rechts, 0.49 mm hoch
 Streuwert 2.25, horizontal: 2.83, vertikal: 1.45

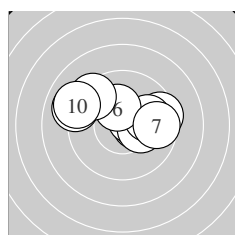
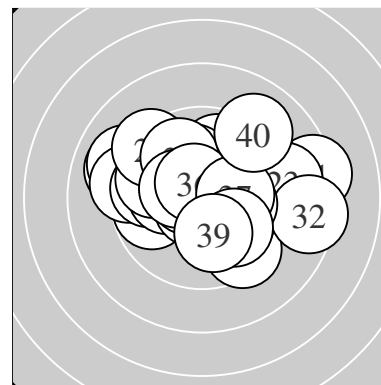

Serie 1:
 9.5 → 10.4 * 10.6 * 10.2 * 10.0 →
 10.3 * 9.6 → 9.0 ← 9.4 ↘ 9.0 ↘
 beste Teiler 97.6 (3.) 129.1 (2.) 175.0 (6.)
 Trefferlage 0.08 mm rechts, 0.96 mm hoch
 Streuwert 2.26, horizontal: 3.03, vertikal: 1.01

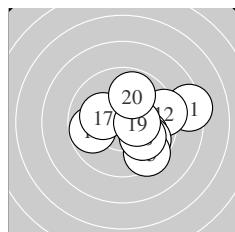

Serie 2:
 8.3 → 9.3 → 10.0 ↘ 9.8 ↘ 9.5 ↘
 9.8 ← 10.2 * 10.0 ↘ 10.4 * 9.9 ↑
 beste Teiler 138.1 (19.) 196.7 (17.) 238.2 (18.)
 Trefferlage 1.66 mm rechts, 0.25 mm tief
 Streuwert 2.20, horizontal: 2.64, vertikal: 1.65

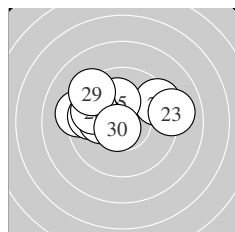

Serie 3:
 9.2 ← 9.4 ↗ 9.0 → 10.1 ← 10.1 ↑
 9.7 ← 10.1 ← 9.8 ← 9.3 ↘ 10.7 *
 beste Teiler 75.0 (30.) 201.9 (24.) 202.7 (27.)
 Trefferlage 0.99 mm links, 1.00 mm hoch
 Streuwert 2.17, horizontal: 2.89, vertikal: 1.01

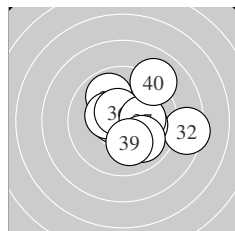

Serie 4:
 9.9 ↘ 8.5 → 10.6 * 10.1 → 10.4 *
 10.6 * 10.2 * 10.0 ↘ 10.1 ↓ 9.0 ↗
 beste Teiler 81.0 (33.) 99.7 (36.) 147.8 (35.)
 Trefferlage 1.16 mm rechts, 0.27 mm hoch
 Streuwert 2.07, horizontal: 2.34, vertikal: 1.76

Unterschrift des Schützen

Ergebnis: **412.7** (395)
 Serien: 103.3 103.6 101.8 104.0
 Zähler: 35 5 0 0 0 0 0 0 0 0
 Innenzehner: 26
 weiteste: 387 (28), 344 (16), 298 (6)
 beste Teiler 6.0 (32.) 13.9 (12.) 39.0 (35.)
 Trefferlage 0.06 mm links, 0.11 mm hoch
 Streuwert 1.28, horizontal: 1.30, vertikal: 1.26

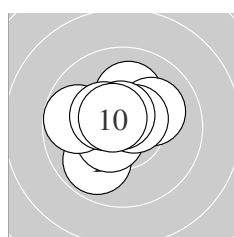
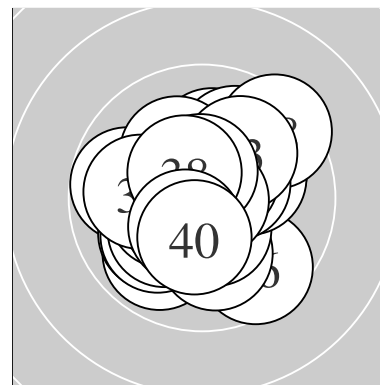

Serie 1:
 9.9 ↙ 10.7 * 10.1 ↑ 10.5 * 10.1 ↗
 9.8 ← 10.6 * 10.6 * 10.4 * 10.6 *
 beste Teiler 52.0 (2.) 79.0 (8.) 89.8 (10.)
 Trefferlage 0.49 mm links, 0.34 mm hoch
 Streuwert 1.24, horizontal: 1.34, vertikal: 1.13

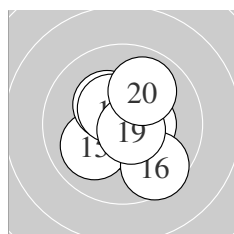

Serie 2:
 10.6 * 10.9 * 10.7 * 10.4 * 10.0 ↙
 9.6 ↘ 10.3 * 10.5 * 10.7 * 9.9 ↗
 beste Teiler 13.9 (12.) 67.6 (19.) 72.0 (13.)
 Trefferlage 0.21 mm rechts, 0.00 mm
 Streuwert 1.31, horizontal: 1.19, vertikal: 1.42

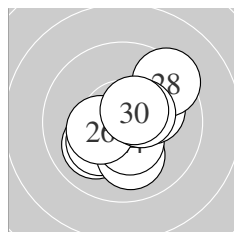

Serie 3:
 10.0 ↙ 10.2 * 10.1 ↓ 10.4 * 10.4 *
 10.3 * 10.1 ↗ 9.4 ↗ 10.4 * 10.5 *
 beste Teiler 108.8 (30.) 131.1 (24.) 135.5 (29.)
 Trefferlage 0.43 mm rechts, 0.10 mm tief
 Streuwert 1.50, horizontal: 1.54, vertikal: 1.46

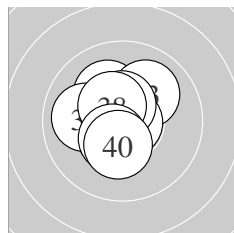

Serie 4:
 10.1 ↘ 10.9 * 10.0 ↗ 10.5 * 10.8 *
 10.0 ← 10.5 * 10.5 * 10.4 * 10.3 *
 beste Teiler 6.0 (32.) 39.0 (35.) 105.1 (37.)
 Trefferlage 0.42 mm links, 0.22 mm hoch
 Streuwert 1.09, horizontal: 1.02, vertikal: 1.16

Unterschrift des Schützen

Meyton Elektronik

Ergebnis: **405.0** (385)
 Serien: 101.1 102.8 100.6 100.5
 Zähler: 26 13 1 0 0 0 0 0 0 0
 Innenzehner: 19
 weiteste: 514 (1), 437 (15), 432 (5)
 beste Teiler 35.7 (12.) 47.2 (40.) 60.6 (14.)
 Trefferlage 0.53 mm rechts, 0.37 mm tief
 Streuwert 1.63, horizontal: 1.98, vertikal: 1.18

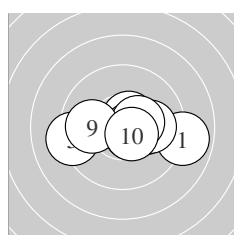
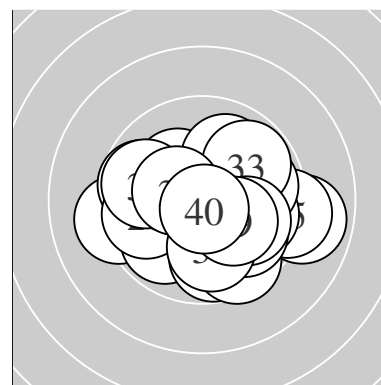

Serie 1:
 8.9 → 10.6 * 10.2 * 10.6 * 9.2 ←
 10.7 * 10.0 → 10.4 * 9.9 ← 10.6 *
 beste Teiler 60.7 (6.) 83.6 (4.) 93.7 (2.)
 Trefferlage 0.61 mm rechts, 0.20 mm tief
 Streuwert 1.84, horizontal: 2.53, vertikal: 0.57

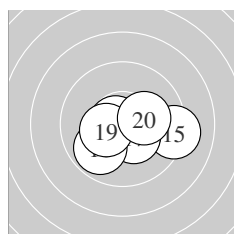

Serie 2:
 10.1 → 10.8 * 10.6 * 10.7 * 9.2 →
 10.5 * 10.4 * 9.9 ↙ 10.4 * 10.2 *
 beste Teiler 35.7 (12.) 60.6 (14.) 96.0 (13.)
 Trefferlage 0.70 mm rechts, 0.45 mm tief
 Streuwert 1.39, horizontal: 1.84, vertikal: 0.72

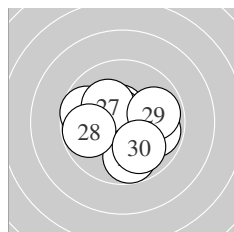

Serie 3:
 10.6 * 9.7 ← 10.0 ↘ 10.7 * 9.8 ↓
 9.9 → 10.2 * 9.8 ← 9.9 → 10.0 ↓
 beste Teiler 71.2 (24.) 95.2 (21.) 183.3 (27.)
 Trefferlage 0.07 mm rechts, 0.40 mm tief
 Streuwert 1.78, horizontal: 2.02, vertikal: 1.49

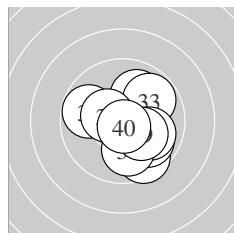

Serie 4:
 10.0 ↗ 9.8 ← 9.8 ↗ 9.6 ↘ 9.9 ↘
 10.4 * 10.0 ↘ 10.0 ↓ 10.2 * 10.8 *
 beste Teiler 47.2 (40.) 136.9 (36.) 190.8 (39.)
 Trefferlage 0.75 mm rechts, 0.44 mm tief
 Streuwert 1.70, horizontal: 1.69, vertikal: 1.71

Unterschrift des Schützen

Meyton Elektronik

Ergebnis: **404.5** (386)
 Serien: 100.2 101.9 100.3 102.1
 Zähler: 26 14 0 0 0 0 0 0 0 0
 Innenzehner: 20
 weiteste: 430 (8), 402 (38), 373 (26)
 beste Teiler 38.6 (5.) 43.1 (15.) 61.9 (37.)
 Trefferlage 0.16 mm rechts, 0.26 mm tief
 Streuwert 1.66, horizontal: 1.75, vertikal: 1.56

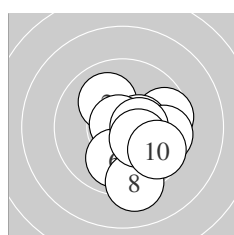
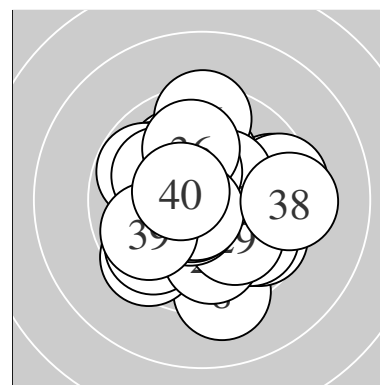

Serie 1:
 9.6 → 10.0 ↘ 10.4 * 9.7 → 10.8 *
 10.0 ↓ 10.4 * 9.2 ↓ 10.4 * 9.7 ↘
 beste Teiler 38.6 (5.) 126.3 (3.) 127.0 (7.)
 Trefferlage 1.15 mm rechts, 0.64 mm tief
 Streuwert 1.64, horizontal: 1.53, vertikal: 1.75

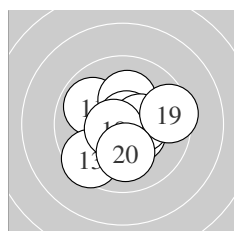

Serie 2:
 9.9 ↖ 10.2 * 9.5 ↗ 10.4 * 10.8 *
 10.5 * 10.4 * 10.6 * 9.5 → 10.1 ↓
 beste Teiler 43.1 (15.) 76.9 (18.) 105.3 (16.)
 Trefferlage 0.13 mm rechts, 0.24 mm tief
 Streuwert 1.60, horizontal: 1.75, vertikal: 1.45

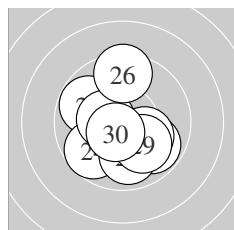

Serie 3:
 9.8 ↘ 10.3 * 9.8 ↖ 9.7 ↗ 10.4 *
 9.5 ↑ 9.9 ↓ 10.2 * 10.1 ↘ 10.6 *
 beste Teiler 95.4 (30.) 131.6 (25.) 172.0 (22.)
 Trefferlage 0.25 mm links, 0.46 mm tief
 Streuwert 1.80, horizontal: 1.71, vertikal: 1.88

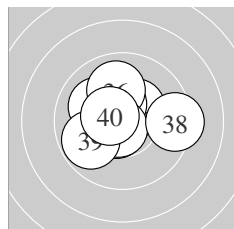

Serie 4:
 10.6 * 10.3 * 10.1 ↖ 10.4 * 10.4 *
 10.0 ↑ 10.7 * 9.3 → 9.8 ↗ 10.5 *
 beste Teiler 61.9 (37.) 77.8 (31.) 105.4 (40.)
 Trefferlage 0.36 mm links, 0.29 mm hoch
 Streuwert 1.52, horizontal: 1.83, vertikal: 1.15

Unterschrift des Schützen

Meyton Elektronik

Ergebnis: **396.7** (378)
 Serien: 94.2 100.9 101.3 100.3
 Zähler: 24 12 3 0 1 0 0 0 0 0
 Innenzehner: 20
 weiteste: 1018 (6), 696 (25), 652 (1)
 beste Teiler 14.8 (28.) 54.1 (5.) 54.3 (26.)
 Trefferlage 1.01 mm links, 0.27 mm tief
 Streuwert 2.25, horizontal: 2.77, vertikal: 1.57

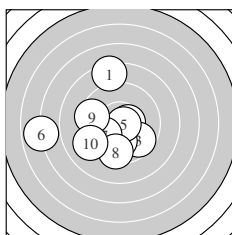
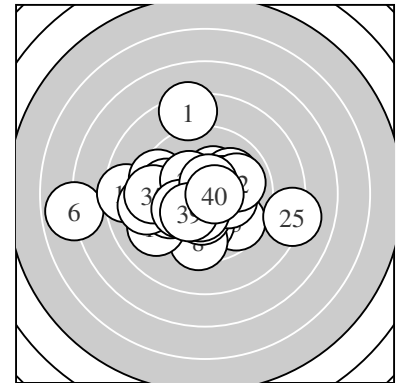

Serie 1:
 8.3 ↑ 10.5 * 9.7 ↘ 10.0 ↓ 10.7 *
 6.9 ← 10.0 ↙ 9.5 ↓ 9.5 ← 9.1 ↙
 beste Teiler 54.1 (5.) 108.7 (2.) 230.0 (4.)
 Trefferlage 1.71 mm links, 0.61 mm tief
 Streuwert 3.19, horizontal: 3.54, vertikal: 2.81

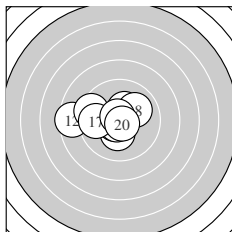

Serie 2:
 10.3 * 8.5 ← 10.3 * 10.6 * 9.4 ↖
 10.7 * 9.7 ← 10.0 ↗ 10.7 * 10.7 *
 beste Teiler 54.4 (20.) 56.0 (19.) 66.5 (16.)
 Trefferlage 1.14 mm links, 0.11 mm hoch
 Streuwert 1.83, horizontal: 2.39, vertikal: 0.99

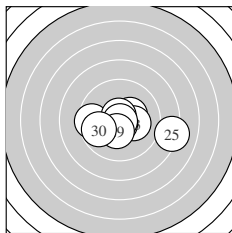

Serie 3:
 10.4 * 10.5 * 10.2 * 9.5 ← 8.2 →
 10.7 * 10.7 * 10.9 * 10.4 * 9.8 ↙
 beste Teiler 14.8 (28.) 54.3 (26.) 59.2 (27.)
 Trefferlage 0.22 mm rechts, 0.47 mm tief
 Streuwert 2.06, horizontal: 2.81, vertikal: 0.80

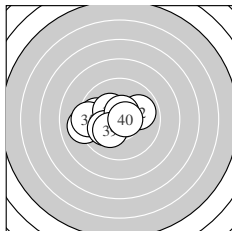

Serie 4:
 9.8 ← 9.9 → 9.1 ← 10.2 * 9.4 ←
 10.3 * 10.1 ↙ 10.6 * 10.2 * 10.7 *
 beste Teiler 73.0 (40.) 85.0 (38.) 163.0 (36.)
 Trefferlage 1.40 mm links, 0.11 mm tief
 Streuwert 1.65, horizontal: 2.14, vertikal: 0.92

Unterschrift des Schützen

Meyton Elektronik

Ergebnis: **408.7** (389)
 Serien: 103.0 100.5 103.2 102.0
 Zähler: 29 11 0 0 0 0 0 0 0 0
 Innenzehner: 27
 weiteste: 418 (14), 418 (29), 418 (34)
 beste Teiler 21.9 (21.) 28.6 (31.) 38.8 (17.)
 Trefferlage 0.48 mm links, 0.01 mm tief
 Streuwert 1.52, horizontal: 1.97, vertikal: 0.84

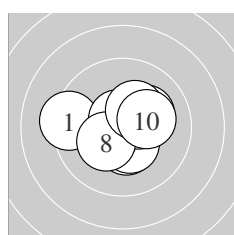
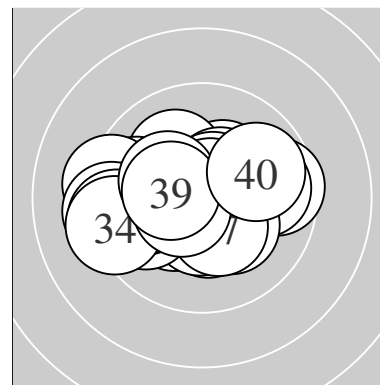

Serie 1:
 9.3 ← 10.8 * 10.4 * 10.2 * 10.7 *
 10.4 * 10.4 * 10.3 * 10.3 * 10.2 *
 beste Teiler 40.2 (2.) 70.3 (5.) 133.2 (7.)
 Trefferlage 0.04 mm rechts, 0.07 mm hoch
 Streuwert 1.42, horizontal: 1.75, vertikal: 0.98

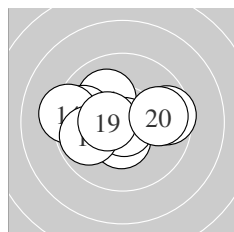

Serie 2:
 10.1 ↖ 9.7 ← 9.6 → 9.3 ← 10.5 *
 10.4 * 10.8 * 9.8 ← 10.5 * 9.8 →
 beste Teiler 38.8 (17.) 116.1 (19.) 121.4 (15.)
 Trefferlage 0.70 mm links, 0.08 mm hoch
 Streuwert 1.80, horizontal: 2.37, vertikal: 0.91

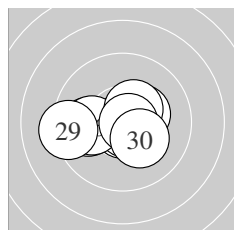

Serie 3:
 10.9 * 10.7 * 10.7 * 9.9 ← 10.3 *
 10.0 ← 10.4 * 10.8 * 9.3 ← 10.2 *
 beste Teiler 21.9 (21.) 45.5 (28.) 51.0 (22.)
 Trefferlage 0.49 mm links, 0.20 mm tief
 Streuwert 1.40, horizontal: 1.87, vertikal: 0.62

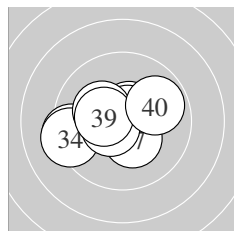

Serie 4:
 10.8 * 9.3 ← 10.6 * 9.3 ← 10.7 *
 10.2 * 10.3 * 10.5 * 10.4 * 9.9 →
 beste Teiler 28.6 (31.) 61.2 (35.) 91.2 (33.)
 Trefferlage 0.76 mm links, 0.01 mm tief
 Streuwert 1.58, horizontal: 2.05, vertikal: 0.91

Unterschrift des Schützen

Meyton Elektronik

Ergebnis: **396.7** (379)
 Serien: 96.4 98.6 102.4 99.3
 Zähler: 21 17 2 0 0 0 0 0 0 0
 Innenzehner: 18
 weiteste: 536 (7), 517 (12), 499 (32)
 beste Teiler 34.6 (26.) 71.3 (15.) 84.0 (22.)
 Trefferlage 0.51 mm rechts, 0.08 mm tief
 Streuwert 2.06, horizontal: 2.13, vertikal: 1.98

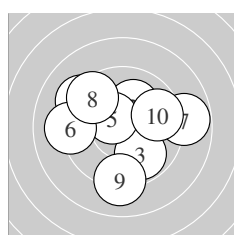
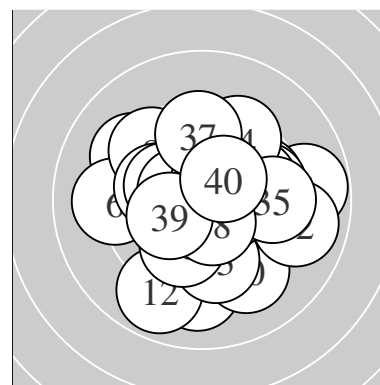

Serie 1:
 10.5 * 10.1 ↗ 9.8 ↘ 9.3 ↖ 10.5 *
 9.1 ← 8.8 → 9.5 ↙ 9.1 ↓ 9.7 →
 beste Teiler 101.0 (1.) 119.7 (5.) 209.3 (2.)
 Trefferlage 0.10 mm links, 0.33 mm hoch
 Streuwert 2.63, horizontal: 3.01, vertikal: 2.19

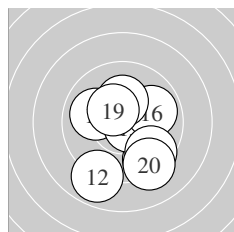

Serie 2:
 9.4 ↘ 8.9 ↙ 10.0 ↖ 10.4 * 10.7 *
 9.9 → 10.2 * 9.5 ↘ 10.4 * 9.2 ↘
 beste Teiler 71.3 (15.) 134.0 (19.) 143.1 (14.)
 Trefferlage 0.50 mm rechts, 0.85 mm tief
 Streuwert 2.16, horizontal: 1.87, vertikal: 2.41

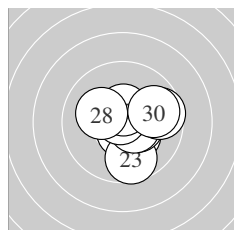

Serie 3:
 10.3 * 10.6 * 9.7 ↓ 10.4 * 10.5 *
 10.8 * 10.5 * 10.2 * 9.6 → 9.8 →
 beste Teiler 34.6 (26.) 84.0 (22.) 105.2 (27.)
 Trefferlage 0.80 mm rechts, 0.21 mm tief
 Streuwert 1.36, horizontal: 1.44, vertikal: 1.28

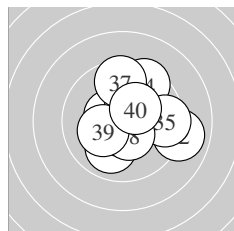

Serie 4:
 10.5 * 9.0 → 10.0 ↙ 9.5 ↗ 9.5 →
 10.3 * 9.6 ↑ 10.4 * 10.2 * 10.3 *
 beste Teiler 121.0 (31.) 127.0 (38.) 155.5 (40.)
 Trefferlage 0.87 mm rechts, 0.40 mm hoch
 Streuwert 2.00, horizontal: 2.11, vertikal: 1.88

Unterschrift des Schützen

Meyton Elektronik