

Ergebnis:	621.0	(590)							
Serien:	103.6	103.7	101.6	103.7	104.0	104.4			
Zähler:	50	10	0	0	0	0	0	0	0
Innenzehner:	43								
weiteste:	341	(50),	321	(30),	300	(25)			
beste Teiler	11.3	(48.)	16.0	(49.)	30.0	(60.)			
Trefferlage	0.28 mm rechts, 0.09 mm hoch								
Streuwert	1.20, horizontal: 1.16, vertikal: 1.24								

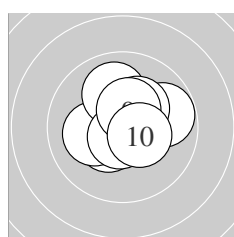

Serie 1:					
	10.6 *	10.4 *	10.2 *	10.0 ↑	9.8 →
	10.8 *	10.3 *	10.7 *	10.4 *	10.4 *
beste Teiler	41.6 (6.) 69.2 (8.) 91.2 (1.)				
Trefferlage	0.16 mm rechts, 0.36 mm hoch				
Streuwert	1.20, horizontal: 1.30, vertikal: 1.08				

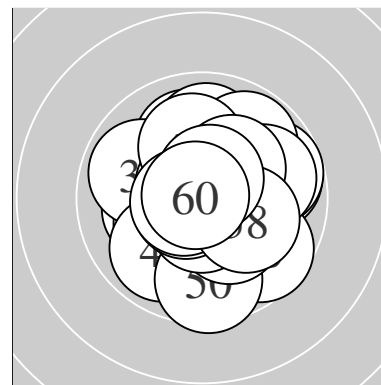
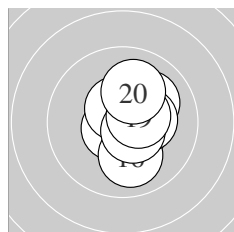

Serie 2:					
	10.6 *	10.1 ↗	10.5 *	10.5 *	10.5 *
	10.0 ↓	10.3 *	10.6 *	10.5 *	10.1 ↑
beste Teiler	77.1 (11.) 94.3 (18.) 103.0 (14.)				
Trefferlage	0.66 mm rechts, 0.21 mm hoch				
Streuwert	1.04, horizontal: 0.76, vertikal: 1.25				

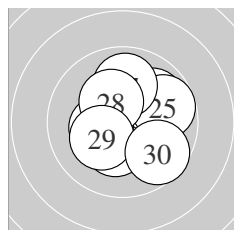

Serie 3:					
	10.6 *	10.6 *	10.3 *	9.9 ↗	9.8 →
	10.3 *	9.9 ↑	10.3 *	10.2 *	9.7 ↘
beste Teiler	80.1 (21.) 88.0 (22.) 154.7 (26.)				
Trefferlage	0.39 mm rechts, 0.02 mm hoch				
Streuwert	1.55, horizontal: 1.57, vertikal: 1.53				

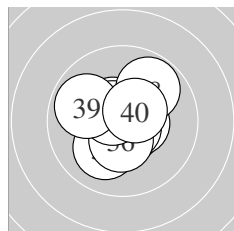

Serie 4:					
	10.7 *	10.5 *	10.1 ↙	10.7 *	10.5 *
	10.4 *	10.6 *	9.8 ↗	9.9 ↖	10.5 *
beste Teiler	64.3 (34.) 75.1 (31.) 89.6 (37.)				
Trefferlage	0.06 mm links, 0.10 mm hoch				
Streuwert	1.22, horizontal: 1.25, vertikal: 1.20				

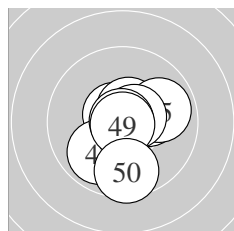

Serie 5:					
	10.7 *	10.2 *	10.7 *	10.6 *	9.9 →
	10.6 *	9.9 ↙	10.9 *	10.9 *	9.6 ↓
beste Teiler	11.3 (48.) 16.0 (49.) 67.1 (41.)				
Trefferlage	0.33 mm rechts, 0.30 mm tief				
Streuwert	1.29, horizontal: 1.17, vertikal: 1.40				

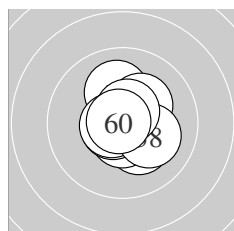

Serie 6:					
	10.2 *	10.4 *	10.1 ↑	10.6 *	10.7 *
	10.6 *	10.3 *	10.1 ↘	10.6 *	10.8 *
beste Teiler	30.0 (60.) 73.4 (55.) 77.8 (56.)				
Trefferlage	0.21 mm rechts, 0.19 mm hoch				
Streuwert	1.02, horizontal: 0.89, vertikal: 1.13				

Meyton Elektronik

LG 60 ZR – Wertung – Frauen

StandNr: 108

Ungerank, Nadine #227

StartNr: 38

17. März 2019 14:23

SG Zell am Ziller / Zell am Ziller 1

Unterschrift des Schützen

Meyton Elektronik

Ergebnis: **603.2** (578)

Serien: 98.9 102.4 100.5 99.4 102.2 99.8

Zähler: 40 18 2 0 0 0 0 0 0 0

Innenzehner: 29

weiteste: 585 (30), 524 (9), 490 (36)

beste Teiler 38.8 (31.) 46.2 (11.) 47.8 (40.)

Trefferlage 0.06 mm links, 0.52 mm hoch

Streuwert 1.82, horizontal: 1.97, vertikal: 1.67

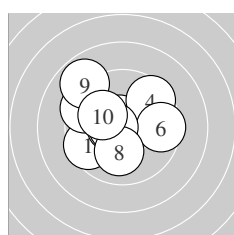
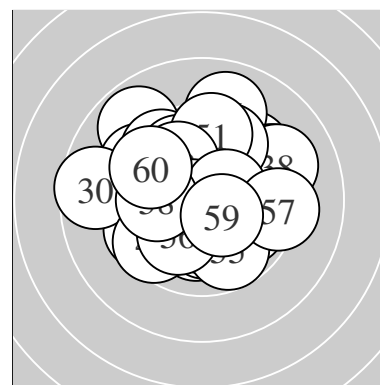

Serie 1:

9.5 ↙	9.4 ↖	10.7 *	9.5 ↗	10.5 *
9.6 →	10.6 *	10.1 ↓	8.9 ↘	10.1 ↖

beste Teiler 73.1 (3.) 84.0 (7.) 101.0 (5.)

Trefferlage 0.82 mm links, 0.61 mm hoch

Streuwert 2.11, horizontal: 2.37, vertikal: 1.82

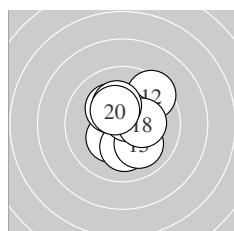

Serie 2:

10.8 *	9.5 ↗	10.3 *	10.1 ↓	10.0 ↘
10.2 *	10.6 *	10.3 *	10.2 *	10.4 *

beste Teiler 46.2 (11.) 81.4 (17.) 145.0 (20.)

Trefferlage 0.29 mm rechts, 0.32 mm hoch

Streuwert 1.43, horizontal: 1.28, vertikal: 1.57

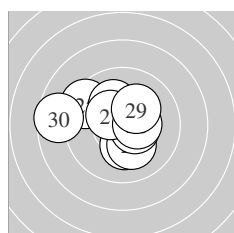

Serie 3:

10.2 *	10.5 *	10.2 *	10.5 *	9.4 ↘
10.1 ↘	10.4 *	10.4 *	10.2 *	8.6 ←

beste Teiler 117.6 (24.) 120.0 (22.) 133.2 (28.)

Trefferlage 0.62 mm links, 0.41 mm hoch

Streuwert 1.91, horizontal: 2.33, vertikal: 1.37

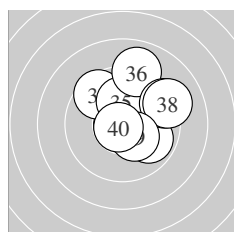

Serie 4:

10.8 *	10.4 *	9.6 ↘	9.9 ↘	10.1 ↑
9.0 ↑	9.3 ↗	9.2 ↗	10.3 *	10.8 *

beste Teiler 38.8 (31.) 47.8 (40.) 128.8 (32.)

Trefferlage 1.00 mm rechts, 1.16 mm hoch

Streuwert 1.93, horizontal: 1.97, vertikal: 1.89

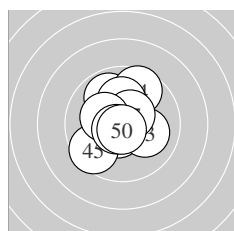

Serie 5:

9.9 ↘	10.6 *	10.1 ↘	9.6 ↑	9.6 ↙
10.1 ↑	10.5 *	10.3 *	10.7 *	10.8 *

beste Teiler 50.8 (50.) 73.8 (49.) 93.0 (42.)

Trefferlage 0.26 mm links, 0.41 mm hoch

Streuwert 1.55, horizontal: 1.39, vertikal: 1.69

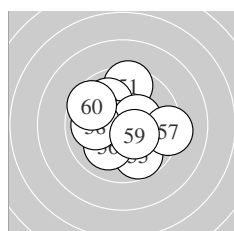

Serie 6:

9.5 ↑	10.0 ↘	10.8 *	10.4 *	9.7 ↓
10.1 ↙	9.3 →	10.0 ←	10.4 *	9.6 ↘

beste Teiler 50.0 (53.) 136.8 (59.) 141.5 (54.)

Trefferlage 0.00 mm , 0.20 mm hoch

Streuwert 1.99, horizontal: 2.11, vertikal: 1.87

Meyton Elektronik

LG 60 ZR – Wertung – Frauen

StandNr: 109

Felderer, Lisa #70233005

StartNr: 39

17. März 2019 14:14

SG_Thaur

Unterschrift des Schützen

Meyton Elektronik

Ergebnis:	596.2	(567)				
Serien:	96.8	98.5	99.6	100.4	100.9	100.0
Zähler:	32	23	5	0	0	0
Innenzehner:	25					
weiteste:	672	(3),	593	(8),	558	(53)
beste Teiler	32.5	(35.)	53.8	(6.)	73.5	(58.)
Trefferlage	0.32 mm rechts, 0.42 mm hoch					
Streuwert	2.02, horizontal: 2.10, vertikal: 1.94					

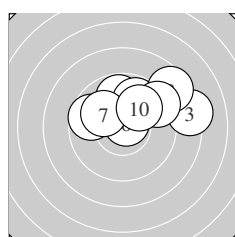
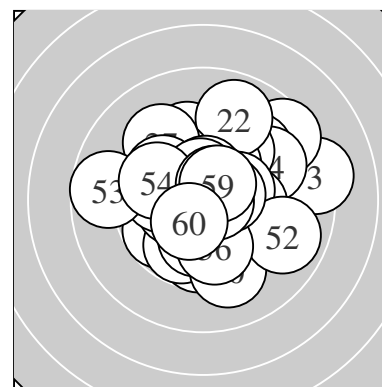

Serie 1:	10.6 *	9.8 ↑	8.3 →	9.8 ↗	9.7 ↖
	10.7 *	10.0 ↘	8.6 ↗	9.3 ↗	10.0 ↗
beste Teiler	53.8 (6.) 79.0 (1.) 227.8 (7.)				
Trefferlage	1.25 mm rechts, 1.81 mm hoch				
Streuwert	2.20, horizontal: 2.94, vertikal: 1.03				

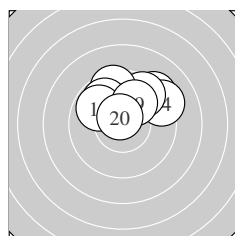

Serie 2:	9.3 ↗	10.3 *	10.3 *	9.2 ↗	9.6 ↗
	9.5 ↑	9.8 ↘	9.8 ↘	10.0 ↗	10.7 *
beste Teiler	75.9 (20.) 157.2 (13.) 167.3 (12.)				
Trefferlage	0.34 mm rechts, 2.08 mm hoch				
Streuwert	1.56, horizontal: 2.04, vertikal: 0.83				

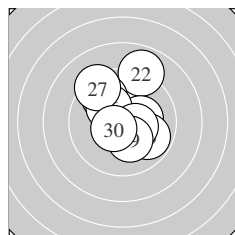

Serie 3:	10.2 *	8.9 ↑	9.8 ↘	10.3 *	9.8 ↘
	10.2 *	9.3 ↘	10.4 *	10.2 *	10.5 *
beste Teiler	106.6 (30.) 131.2 (28.) 175.9 (24.)				
Trefferlage	0.17 mm rechts, 0.99 mm hoch				
Streuwert	1.92, horizontal: 1.69, vertikal: 2.12				

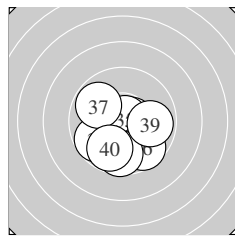

Serie 4:	10.6 *	10.2 *	10.2 *	9.7 ↙	10.8 *
	9.7 ↘	9.8 ↘	9.7 ↓	9.9 →	9.8 ↙
beste Teiler	32.5 (35.) 86.3 (31.) 181.8 (32.)				
Trefferlage	0.10 mm rechts, 1.16 mm tief				
Streuwert	1.62, horizontal: 1.73, vertikal: 1.51				

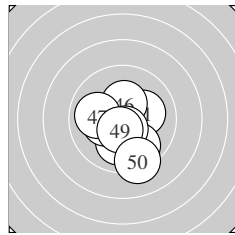

Serie 5:	10.1 →	10.1 ↓	9.8 ↘	10.0 ↓	10.3 *
	10.3 *	10.0 ←	10.6 *	10.5 *	9.2 ↓
beste Teiler	100.8 (48.) 109.1 (49.) 151.7 (46.)				
Trefferlage	0.07 mm rechts, 1.08 mm tief				
Streuwert	1.54, horizontal: 1.38, vertikal: 1.68				

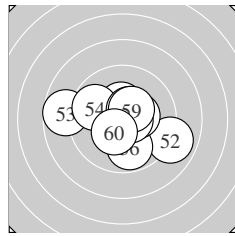

Serie 6:	10.4 *	8.9 ↘	8.7 ←	9.8 ↖	10.5 *
	9.8 ↓	10.4 *	10.7 *	10.4 *	10.4 *
beste Teiler	73.5 (58.) 112.6 (55.) 127.4 (59.)				
Trefferlage	0.02 mm links, 0.08 mm tief				
Streuwert	2.15, horizontal: 2.68, vertikal: 1.43				

Meyton Elektronik

LG 60 ZR – Wertung – **Frauen**
StandNr: 110
Binder,, Kristina #70302062

StartNr: 40
17. März 2019 14:14
SG_Fieberbrunn

Unterschrift des Schützen

Meyton Elektronik

Ergebnis: **610.9** (587)
 Serien: 100.4 101.4 102.4 103.0 103.4 100.3
 Zähler: 47 13 0 0 0 0 0 0 0
 Innenzehner: 34
 weiteste: 480 (60), 468 (18), 445 (1)
 beste Teiler 1.4 (48.) 40.3 (33.) 76.0 (45.)
 Trefferlage 0.22 mm rechts, 0.39 mm tief
 Streuwert 1.51, horizontal: 1.54, vertikal: 1.47

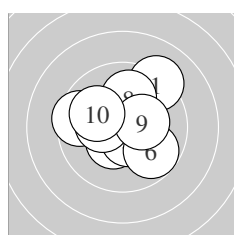
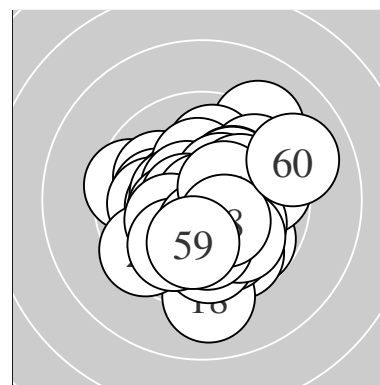

Serie 1:
 9.2 ↗ 10.4 * 10.4 * 9.5 ← 10.5 *
 9.8 ↘ 10.3 * 10.0 ↑ 10.3 * 10.0 ↖
 beste Teiler 104.2 (5.) 134.7 (2.) 135.6 (3.)
 Trefferlage 0.07 mm rechts, 0.37 mm hoch
 Streuwert 1.84, horizontal: 2.01, vertikal: 1.66

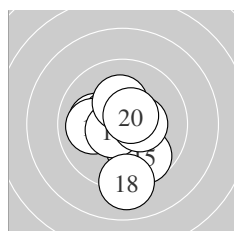

Serie 2:
 10.1 ← 10.1 ↘ 10.5 * 10.0 ← 9.7 ↘
 10.6 * 10.4 * 9.1 ↓ 10.3 * 10.6 *
 beste Teiler 91.0 (16.) 95.4 (20.) 119.4 (13.)
 Trefferlage 0.15 mm links, 0.67 mm tief
 Streuwert 1.66, horizontal: 1.42, vertikal: 1.88

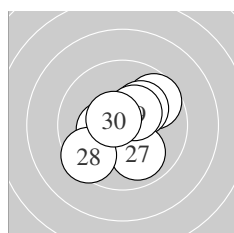

Serie 3:
 10.6 * 10.6 * 9.7 ↗ 10.3 * 10.2 *
 10.6 * 9.9 ↘ 9.5 ↖ 10.4 * 10.6 *
 beste Teiler 79.3 (22.) 86.5 (30.) 96.0 (21.)
 Trefferlage 0.06 mm links, 0.16 mm tief
 Streuwert 1.51, horizontal: 1.58, vertikal: 1.43

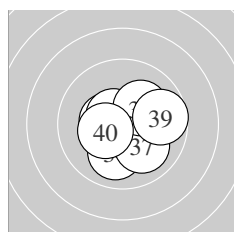

Serie 4:
 10.4 * 10.4 * 10.8 * 10.0 ↓ 10.6 *
 10.5 * 10.0 ↘ 10.2 * 9.7 → 10.4 *
 beste Teiler 40.3 (33.) 95.1 (35.) 117.0 (36.)
 Trefferlage 0.49 mm rechts, 0.15 mm tief
 Streuwert 1.29, horizontal: 1.46, vertikal: 1.09

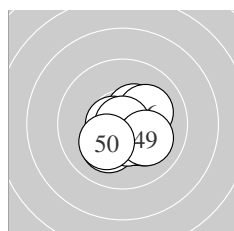

Serie 5:
 10.4 * 10.1 ↘ 10.4 * 10.1 ↖ 10.6 *
 10.1 ↗ 10.5 * 10.9 * 10.1 ↘ 10.2 *
 beste Teiler 1.4 (48.) 76.0 (45.) 121.7 (47.)
 Trefferlage 0.45 mm rechts, 0.56 mm tief
 Streuwert 1.10, horizontal: 1.21, vertikal: 0.98

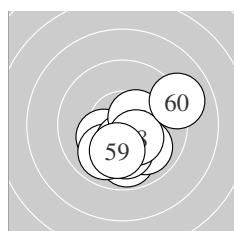

Serie 6:
 10.2 * 9.8 ↓ 9.9 ↖ 10.4 * 10.5 *
 9.9 ↘ 10.1 ↓ 10.4 * 10.1 ↓ 9.0 →
 beste Teiler 121.8 (55.) 135.0 (54.) 148.5 (58.)
 Trefferlage 0.56 mm rechts, 1.16 mm tief
 Streuwert 1.58, horizontal: 1.71, vertikal: 1.43

Meyton Elektronik

LG 60 ZR – Wertung – Frauen

StandNr: 111

van, Duijn, Pascale #70808111

StartNr: 41

17. März 2019 14:02

SG_Kaltenbach-Ried

Unterschrift des Schützen

Meyton Elektronik

Ergebnis:	589.4	(565)				
Serien:	96.6	95.7	98.9	100.6	98.0	99.6
Zähler:	31	26	2	0	0	1 0 0 0 0
Innenzehner:	26					
weiteste:	1336 (21), 577 (7), 554 (18)					
beste Teiler	26.1 (51.) 70.3 (27.) 76.4 (42.)					
Trefferlage	0.58 mm links, 0.29 mm tief					
Streuwert	2.39, horizontal: 2.73, vertikal: 1.99					

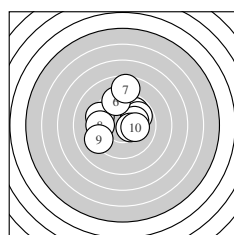
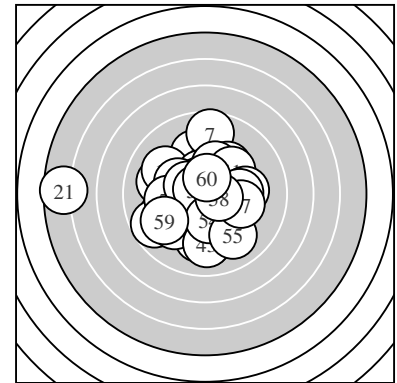

Serie 1:

9.8 ↗	9.8 ↗	9.4 ↖	10.2 *	10.5 *
9.4 ↑	8.6 ↑	9.5 ←	9.2 ↙	10.2 *
beste Teiler	125.2 (5.) 199.0 (4.) 199.4 (10.)			
Trefferlage	0.21 mm links, 1.23 mm hoch			
Streuwert	2.41, horizontal: 2.54, vertikal: 2.27			

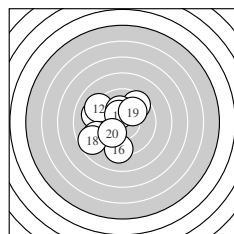

Serie 2:

9.2 ↖	9.2 ↖	9.6 ↗	10.2 *	9.1 ↙
9.3 ↓	10.4 *	8.7 ↙	10.0 ↗	10.0 ↙
beste Teiler	132.8 (17.) 193.3 (14.) 230.6 (19.)			
Trefferlage	1.64 mm links, 0.00 mm			
Streuwert	2.47, horizontal: 2.47, vertikal: 2.46			

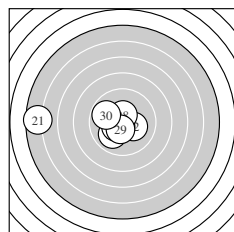

Serie 3:

5.6 ←	10.2 *	10.6 *	10.6 *	10.0 ↙
10.4 *	10.7 *	10.5 *	10.5 *	9.8 ↖
beste Teiler	70.3 (27.) 80.9 (23.) 100.8 (24.)			
Trefferlage	1.88 mm links, 0.34 mm tief			
Streuwert	3.03, horizontal: 4.18, vertikal: 0.96			

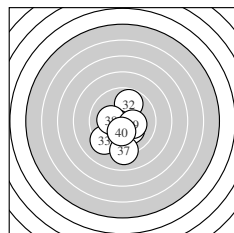

Serie 4:

10.5 *	9.8 ↑	9.3 ↙	10.6 *	10.3 *
10.2 *	9.1 ↓	10.2 *	10.3 *	10.3 *
beste Teiler	97.2 (34.) 122.4 (31.) 164.9 (40.)			
Trefferlage	0.26 mm links, 1.04 mm tief			
Streuwert	1.71, horizontal: 1.42, vertikal: 1.96			

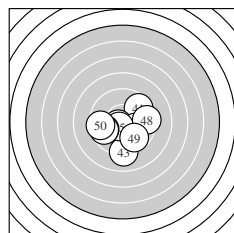

Serie 5:

9.6 ↗	10.6 *	9.1 ↓	10.1 ↘	10.6 *
9.7 ↙	9.7 ↙	9.4 →	9.7 ↘	9.5 ←
beste Teiler	76.4 (42.) 88.4 (45.) 219.5 (44.)			
Trefferlage	0.01 mm links, 0.93 mm tief			
Streuwert	2.19, horizontal: 2.53, vertikal: 1.78			

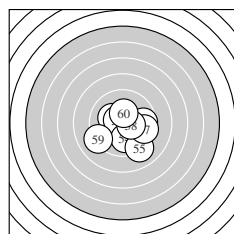

Serie 6:

10.8 *	10.2 *	10.6 *	10.0 ↓	9.1 ↘
9.6 →	9.5 ↘	10.4 *	9.1 ↙	10.3 *
beste Teiler	26.1 (51.) 90.5 (53.) 136.3 (58.)			
Trefferlage	0.49 mm rechts, 0.68 mm tief			
Streuwert	2.02, horizontal: 2.28, vertikal: 1.73			

Meyton Elektronik

LG 60 ZR – Wertung – Frauen

StandNr: 112

Schlichtherle,, Vanessa #70423013

StartNr: 42

17. März 2019 14:28

SG_Walchsee / Walchsee 1

Unterschrift des Schützen

Meyton Elektronik

Ergebnis: **602.4** (574)

Serien: 99.6 101.2 98.0 102.9 102.0 98.7

Zähler: 37 20 3 0 0 0 0 0 0 0

Innenzehner: 30

weiteste: 605 (8), 520 (28), 508 (55)

beste Teiler 23.0 (16.) 49.0 (36.) 65.5 (7.)

Trefferlage 0.04 mm rechts, 0.20 mm hoch

Streuwert 1.86, horizontal: 2.16, vertikal: 1.49

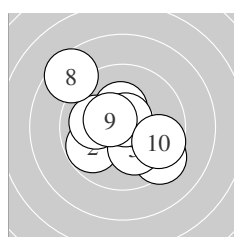
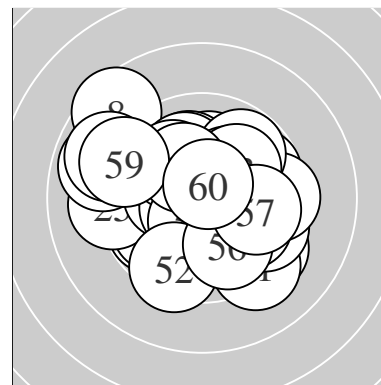

Serie 1:

9.4 ↘	9.8 ↙	10.3 *	10.5 *	10.2 *
10.0 ←	10.7 *	8.5 ↘	10.5 *	9.7 →

beste Teiler 65.5 (7.) 121.0 (9.) 122.2 (4.)

Trefferlage 0.19 mm links, 0.02 mm tief

Streuwert 2.19, horizontal: 2.38, vertikal: 1.98

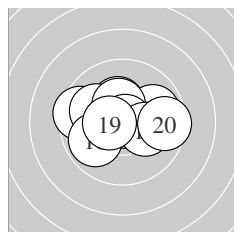

Serie 2:

10.3 *	9.5 ←	10.0 ↘	9.9 →	10.4 *
10.9 *	10.2 *	9.9 ↙	10.5 *	9.6 →

beste Teiler 23.0 (16.) 110.2 (19.) 144.8 (15.)

Trefferlage 0.17 mm links, 0.33 mm hoch

Streuwert 1.73, horizontal: 2.26, vertikal: 0.94

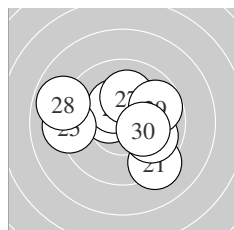

Serie 3:

9.2 ↘	10.5 *	9.9 ↗	10.4 *	9.2 ←
9.9 →	10.1 ↑	8.9 ←	9.7 →	10.2 *

beste Teiler 123.5 (22.) 149.4 (24.) 180.8 (30.)

Trefferlage 0.09 mm rechts, 0.24 mm hoch

Streuwert 2.35, horizontal: 2.89, vertikal: 1.65

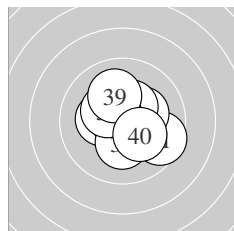

Serie 4:

9.6 ↘	10.7 *	10.3 *	10.3 *	10.4 *
10.8 *	10.2 *	10.3 *	10.1 ↑	10.2 *

beste Teiler 49.0 (36.) 69.4 (32.) 137.7 (35.)

Trefferlage 0.30 mm rechts, 0.13 mm hoch

Streuwert 1.35, horizontal: 1.46, vertikal: 1.23

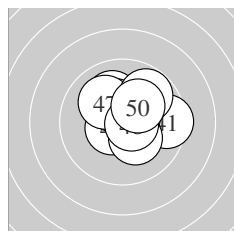

Serie 5:

9.5 →	10.5 *	10.6 *	10.1 ↑	10.3 *
10.3 *	10.1 ↘	10.6 *	9.8 ↗	10.2 *

beste Teiler 76.9 (48.) 88.8 (43.) 101.5 (42.)

Trefferlage 0.56 mm rechts, 0.68 mm hoch

Streuwert 1.40, horizontal: 1.57, vertikal: 1.19

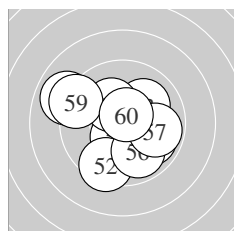

Serie 6:

10.5 *	9.5 ↓	10.1 ↗	9.9 ↘	8.9 ↙
9.9 ↘	9.8 →	10.2 *	9.2 ←	10.7 *

beste Teiler 75.2 (60.) 123.8 (51.) 177.3 (58.)

Trefferlage 0.30 mm links, 0.13 mm tief

Streuwert 2.23, horizontal: 2.50, vertikal: 1.92

Meyton Elektronik

LG 60 ZR – Wertung – Frauen

StandNr: 113

Holzmann,, Nadine #70218004

StartNr: 43

17. März 2019 14:09

SG_Matrei–Mühlbachl–Pfans

Unterschrift des Schützen

Meyton Elektronik

Ergebnis:	598.3	(572)
Serien:	100.3 102.4 99.5 98.6 98.5 99.0	
Zähler:	36 20 4 0 0 0 0 0 0	
Innenzehner:	31	
weiteste:	588 (50), 579 (24), 570 (38)	
beste Teiler	45.0 (18.) 49.7 (34.) 52.7 (27.)	
Trefferlage	0.78 mm links, 0.96 mm hoch	
Streuwert	1.83, horizontal: 2.23, vertikal: 1.33	

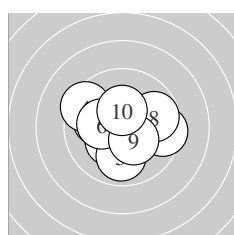
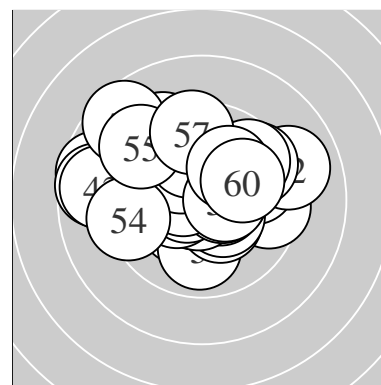

Serie 1:					
	10.0 ↖	10.4 *	10.3 *	9.4 ↖	9.9 ↓
	10.2 *	9.5 →	9.8 →	10.4 *	10.4 *
beste Teiler	139.1 (2.) 150.0 (10.) 150.2 (9.)				
Trefferlage	0.00 mm , 0.05 mm tief				
Streuwert	1.84, horizontal: 2.21, vertikal: 1.36				

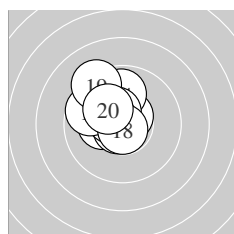

Serie 2:					
	10.2 *	10.6 *	10.7 *	9.9 ↑	10.5 *
	10.5 *	9.7 ↖	10.8 *	9.3 ↘	10.2 *
beste Teiler	45.0 (18.) 58.6 (13.) 87.6 (12.)				
Trefferlage	0.99 mm links, 1.01 mm hoch				
Streuwert	1.19, horizontal: 1.09, vertikal: 1.28				

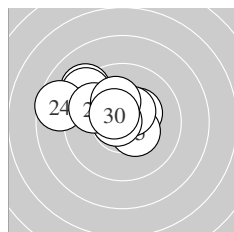

Serie 3:					
	9.2 ↘	9.3 ↘	10.3 *	8.6 ↖	10.4 *
	10.5 *	10.7 *	9.8 ↖	10.2 *	10.5 *
beste Teiler	52.7 (27.) 105.3 (30.) 120.8 (26.)				
Trefferlage	1.35 mm links, 1.19 mm hoch				
Streuwert	1.79, horizontal: 2.27, vertikal: 1.12				

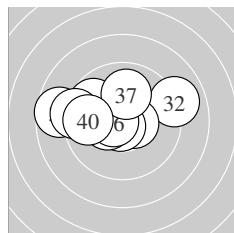

Serie 4:					
	9.7 ↘	9.0 →	10.5 *	10.8 *	10.4 *
	10.6 *	10.0 ↑	8.7 ←	9.2 ←	9.7 ←
beste Teiler	49.7 (34.) 81.1 (36.) 101.0 (33.)				
Trefferlage	1.20 mm links, 0.62 mm hoch				
Streuwert	2.18, horizontal: 2.92, vertikal: 0.99				

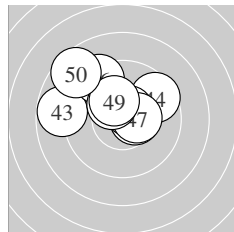

Serie 5:					
	10.2 *	10.5 *	8.8 ←	9.6 ↗	10.6 *
	9.3 ↘	10.4 *	10.3 *	10.2 *	8.6 ↘
beste Teiler	91.0 (45.) 109.2 (42.) 128.4 (47.)				
Trefferlage	0.84 mm links, 1.56 mm hoch				
Streuwert	2.04, horizontal: 2.53, vertikal: 1.38				

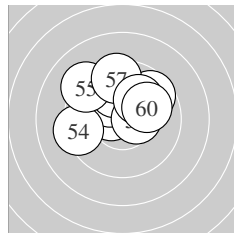

Serie 6:					
	10.5 *	10.2 *	10.0 ↑	9.3 ←	9.2 ↘
	9.7 ↗	9.5 ↑	10.5 *	10.1 ↗	10.0 →
beste Teiler	105.3 (51.) 123.0 (58.) 189.4 (52.)				
Trefferlage	0.33 mm links, 1.45 mm hoch				
Streuwert	1.83, horizontal: 2.18, vertikal: 1.40				

Meyton Elektronik

LG 60 ZR – Wertung – Frauen

StandNr: 114

Hackl., Anna #70103061

StartNr: 44

17. März 2019 14:24

SG_Imst

Unterschrift des Schützen

Meyton Elektronik

Ergebnis:	578.4	(549)
Serien:	95.5 95.9 93.0 98.8 97.3 97.9	
Zähler:	21 29 8 2 0 0 0 0 0 0	
Innenzehner:	17	
weiteste:	986 (22), 804 (13), 720 (26)	
beste Teiler	17.8 (46.) 37.6 (39.) 55.4 (45.)	
Trefferlage	0.86 mm links, 0.49 mm hoch	
Streuwert	2.62, horizontal: 2.78, vertikal: 2.45	

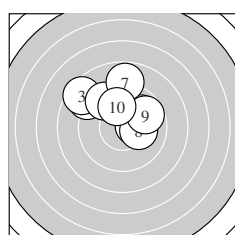
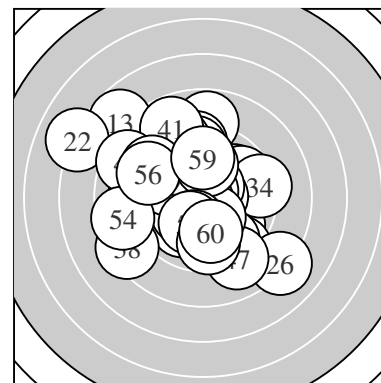

Serie 1:	8.8 ↘	10.4 *	8.5 ↘	9.9 ↗	9.9 ↗
	9.4 ↘	8.8 ↑	10.2 *	9.7 ↗	9.9 ↑
beste Teiler	137.7 (2.) 194.1 (8.) 253.2 (10.)				
Trefferlage	0.11 mm links, 2.17 mm hoch				
Streuwert	2.31, horizontal: 2.77, vertikal: 1.73				

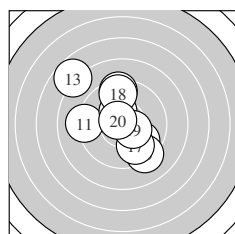

Serie 2:	9.1 ←	9.8 ↘	7.7 ↘	9.4 ↑	9.2 ↘
	10.3 *	9.8 ↘	9.5 ↑	10.4 *	10.7 *
beste Teiler	74.0 (20.) 137.3 (19.) 161.6 (16.)				
Trefferlage	0.51 mm links, 0.64 mm hoch				
Streuwert	2.88, horizontal: 2.77, vertikal: 2.97				

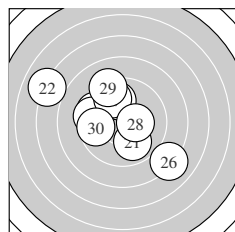

Serie 3:	9.9 ↘	7.0 ↘	9.9 ↑	9.6 ↖	9.5 ←
	8.1 ↘	9.8 ↘	10.3 *	9.2 ↖	9.7 ←
beste Teiler	152.2 (28.) 259.3 (21.) 262.1 (23.)				
Trefferlage	1.43 mm links, 0.79 mm hoch				
Streuwert	3.36, horizontal: 3.83, vertikal: 2.81				

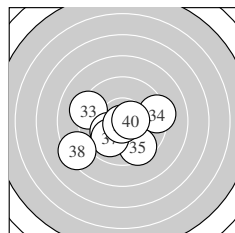

Serie 4:	10.4 *	10.4 *	9.2 ↖	9.3 →	9.6 ↘
	10.1 ↗	10.0 ↗	8.4 ↗	10.8 *	10.6 *
beste Teiler	37.6 (39.) 96.6 (40.) 135.8 (32.)				
Trefferlage	0.38 mm links, 0.96 mm tief				
Streuwert	2.28, horizontal: 2.83, vertikal: 1.56				

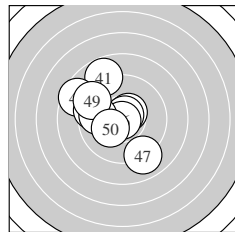

Serie 5:	8.8 ↘	8.6 ↖	9.5 ↖	10.5 *	10.7 *
	10.9 *	9.0 ↘	9.8 ←	9.3 ↖	10.2 *
beste Teiler	17.8 (46.) 55.4 (45.) 104.9 (44.)				
Trefferlage	1.59 mm links, 0.69 mm hoch				
Streuwert	2.41, horizontal: 2.39, vertikal: 2.42				

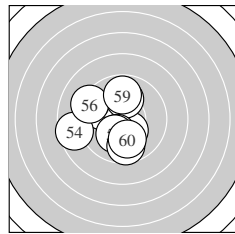

Serie 6:	10.3 *	9.9 ↖	10.0 ↑	8.6 ←	10.2 *
	9.2 ↖	10.2 *	9.7 ↓	9.8 ↑	10.0 ↓
beste Teiler	158.1 (51.) 181.2 (55.) 199.4 (57.)				
Trefferlage	1.17 mm links, 0.39 mm tief				
Streuwert	2.17, horizontal: 2.18, vertikal: 2.16				

Meyton Elektronik

LG 60 ZR – Wertung – Frauen

StandNr: 115

Kranebitter,, Bianca #70226006

StartNr: 45

17. März 2019 14:03

SG_Scharnitz

Unterschrift des Schützen

Meyton Elektronik

Ergebnis:	610.4	(581)
Serien:	102.5	101.0 102.2 101.8 102.4 100.5
Zähler:	42	17 1 0 0 0 0 0 0 0
Innenzehner:	37	
weiteste:	565	(54), 457 (19), 438 (52)
beste Teiler	10.0	(26.) 24.0 (51.) 35.0 (8.)
Trefferlage	0.19 mm	links, 0.29 mm hoch
Streuwert	1.61,	horizontal: 1.70, vertikal: 1.52

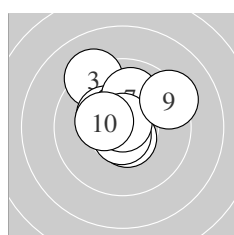
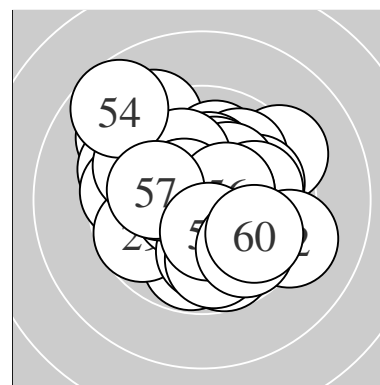

Serie 1:	10.7 *	10.6 *	9.2 ↖	10.3 *	10.7 *
	10.5 *	10.0 ↑	10.8 *	9.3 ↗	10.4 *
beste Teiler	35.0	(8.) 62.2	(5.) 66.7	(1.)	
Trefferlage	0.05 mm	links, 1.01 mm	hoch		
Streuwert	1.47,	horizontal: 1.56,	vertikal: 1.39		

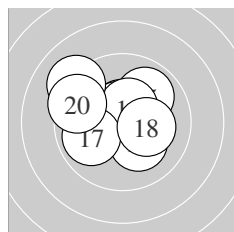

Serie 2:	10.6 *	10.2 *	10.5 *	10.6 *	9.9 ↗
	10.5 *	9.9 ↖	10.2 *	9.1 ↘	9.5 ↖
beste Teiler	79.3	(11.) 93.3	(14.) 102.4	(13.)	
Trefferlage	0.54 mm	links, 0.63 mm	hoch		
Streuwert	1.71,	horizontal: 2.00,	vertikal: 1.36		

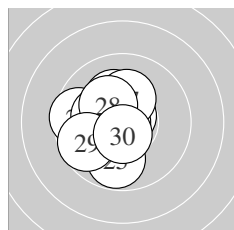

Serie 3:	9.6 ↖	10.7 *	10.2 *	10.2 *	9.8 ↓
	10.9 *	10.2 *	10.3 *	9.7 ↖	10.6 *
beste Teiler	10.0	(26.) 58.8	(22.) 92.0	(30.)	
Trefferlage	0.95 mm	links, 0.09 mm	hoch		
Streuwert	1.39,	horizontal: 1.28,	vertikal: 1.48		

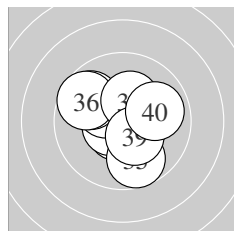

Serie 4:	10.6 *	10.6 *	10.3 *	9.8 ↘	9.7 ↓
	9.7 ↖	10.5 *	10.3 *	10.4 *	9.9 →
beste Teiler	89.9	(31.) 95.2	(32.) 123.4	(37.)	
Trefferlage	0.15 mm	links, 0.13 mm	hoch		
Streuwert	1.58,	horizontal: 1.70,	vertikal: 1.46		

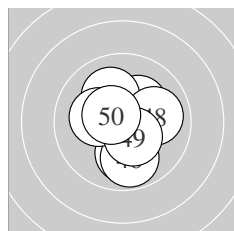

Serie 5:	10.5 *	10.7 *	10.2 *	10.1 ↖	10.0 ↓
	9.8 ↓	10.2 *	10.0 →	10.4 *	10.5 *
beste Teiler	64.1	(42.) 102.3	(50.) 118.0	(41.)	
Trefferlage	0.14 mm	rechts, 0.02 mm	hoch		
Streuwert	1.40,	horizontal: 1.20,	vertikal: 1.58		

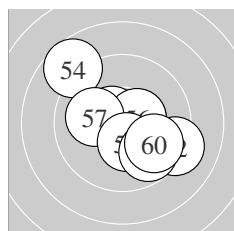

Serie 6:	10.9 *	9.2 ↘	10.5 *	8.7 ↖	10.6 *
	10.5 *	10.1 ↖	10.4 *	9.8 ↘	9.8 ↘
beste Teiler	24.0	(51.) 99.8	(55.) 115.4	(53.)	
Trefferlage	0.39 mm	rechts, 0.12 mm	tief		
Streuwert	2.07,	horizontal: 2.27,	vertikal: 1.85		

LG 60 ZR – Wertung – Frauen

StandNr: 116

Schwarzenauer,, Cornelia #70302080

StartNr: 46

17. März 2019 14:20

SG_Fieberbrunn

Unterschrift des Schützen

Meyton Elektronik

Ergebnis: **602.5** (578)

Serien: 98.6 101.2 103.3 100.5 99.8 99.1

Zähler: 38 22 0 0 0 0 0 0 0 0

Innenzehner: 26

weiteste: 480 (52), 475 (32), 441 (10)

beste Teiler 41.5 (11.) 53.0 (26.) 79.6 (13.)

Trefferlage 0.37 mm links, 0.20 mm hoch

Streuwert 1.76, horizontal: 2.02, vertikal: 1.45

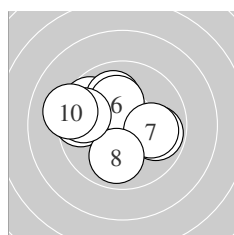
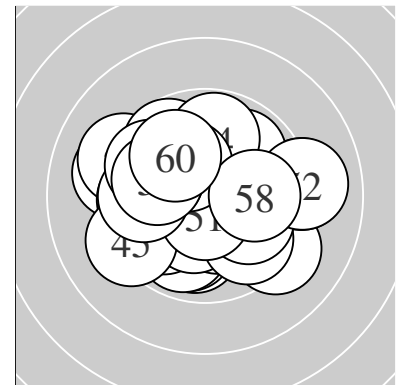

Serie 1:

9.7 ↖	10.0 ↗	9.8 →	10.6 *	9.6 ←
10.2 *	10.0 →	9.9 ↓	9.6 ←	9.2 ←

beste Teiler 88.3 (4.) 188.4 (6.) 234.0 (2.)

Trefferlage 1.11 mm links, 0.43 mm hoch

Streuwert 1.94, horizontal: 2.34, vertikal: 1.43

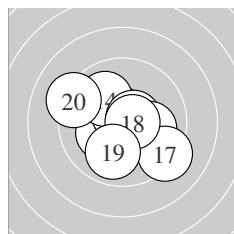

Serie 2:

10.8 *	10.2 *	10.6 *	10.0 ↖	10.6 *
10.1 →	9.2 ↘	10.6 *	9.9 ↓	9.2 ↖

beste Teiler 41.5 (11.) 79.6 (13.) 81.0 (18.)

Trefferlage 0.04 mm links, 0.14 mm tief

Streuwert 1.83, horizontal: 2.10, vertikal: 1.52

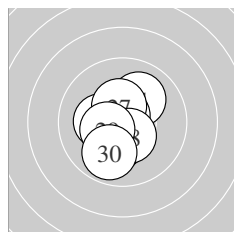

Serie 3:

10.1 ↗	10.6 *	10.2 *	10.2 *	10.3 *
10.7 *	10.4 *	10.5 *	10.4 *	9.9 ↓

beste Teiler 53.0 (26.) 86.3 (22.) 123.0 (28.)

Trefferlage 0.38 mm links, 0.30 mm tief

Streuwert 1.19, horizontal: 0.88, vertikal: 1.43

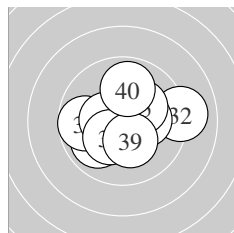

Serie 4:

9.9 ↙	9.1 →	9.7 ←	10.2 *	10.2 *
10.5 *	10.4 *	10.3 *	10.3 *	9.9 ↑

beste Teiler 116.0 (36.) 132.5 (37.) 166.2 (38.)

Trefferlage 0.04 mm rechts, 0.01 mm tief

Streuwert 1.84, horizontal: 2.25, vertikal: 1.31

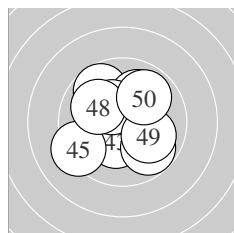

Serie 5:

10.4 *	9.7 ↖	10.3 *	10.0 ↗	9.3 ←
9.8 ↘	10.4 *	10.0 ↖	10.0 ↘	9.9 ↗

beste Teiler 147.5 (41.) 149.0 (47.) 163.5 (43.)

Trefferlage 0.24 mm links, 0.33 mm hoch

Streuwert 1.90, horizontal: 1.96, vertikal: 1.85

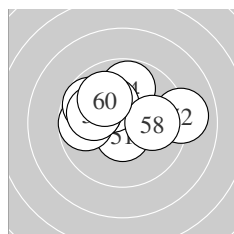

Serie 6:

10.6 *	9.0 →	9.7 ←	9.8 ↑	10.3 *
10.0 ↖	9.7 ↖	10.0 →	10.0 ←	10.0 ↖

beste Teiler 90.0 (51.) 172.6 (55.) 243.0 (58.)

Trefferlage 0.50 mm links, 0.91 mm hoch

Streuwert 1.92, horizontal: 2.50, vertikal: 1.08

Meyton Elektronik

LG 60 ZR – Wertung – **Frauen**

StartNr: 47

StandNr: 117

17. März 2019 14:28

Bindhammer,, Edith #70420059

SG_Söller_Sportschützen / Söller Sportschützen 1

Unterschrift des Schützen

Meyton Elektronik

Ergebnis: **602.4** (575)

Serien: 101.2 101.3 100.8 102.9 96.9 99.3

Zähler: 36 23 1 0 0 0 0 0 0

Innenzehner: 27

weiteste: 501 (46), 479 (2), 440 (56)

beste Teiler 11.7 (3.) 17.8 (26.) 51.1 (13.)

Trefferlage 0.02 mm links, 0.45 mm hoch

Streuwert 1.83, horizontal: 1.94, vertikal: 1.71

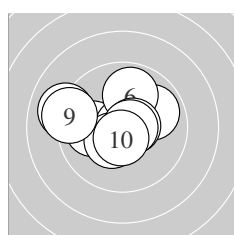
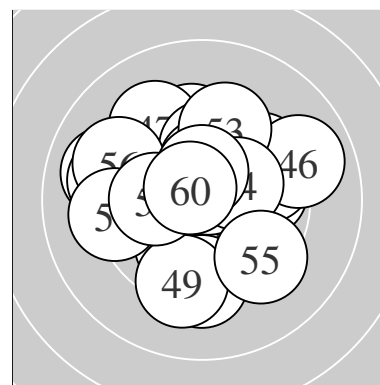

Serie 1:

10.0 ←	9.0 ←	10.9 *	9.9 →	10.4 *
9.9 ↑	10.6 *	10.7 *	9.2 ←	10.6 *

beste Teiler 11.7 (3.) 61.1 (8.) 83.6 (7.)

Trefferlage 0.78 mm links, 0.41 mm hoch

Streuwert 1.80, horizontal: 2.29, vertikal: 1.11

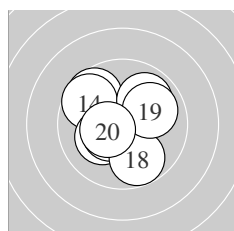

Serie 2:

10.4 *	9.7 ↘	10.7 *	9.7 ↘	10.2 *
10.5 *	9.9 ↗	9.8 ↓	10.0 →	10.4 *

beste Teiler 51.1 (13.) 125.2 (16.) 128.7 (20.)

Trefferlage 0.19 mm links, 0.30 mm hoch

Streuwert 1.67, horizontal: 1.76, vertikal: 1.57

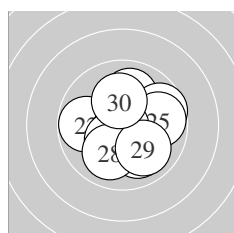

Serie 3:

10.0 ↘	9.8 ←	10.0 ↑	9.7 →	9.8 →
10.9 *	10.4 *	10.0 ↓	10.0 ↘	10.2 *

beste Teiler 17.8 (26.) 145.6 (27.) 197.8 (30.)

Trefferlage 0.41 mm rechts, 0.14 mm tief

Streuwert 1.74, horizontal: 1.84, vertikal: 1.65

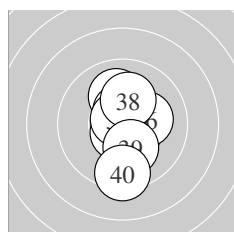

Serie 4:

10.0 ↑	10.5 *	10.6 *	10.5 *	10.6 *
10.2 *	10.7 *	10.2 *	10.2 *	9.4 ↓

beste Teiler 53.8 (37.) 77.8 (33.) 77.8 (35.)

Trefferlage 0.31 mm rechts, 0.06 mm tief

Streuwert 1.40, horizontal: 0.74, vertikal: 1.83

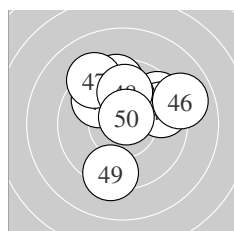

Serie 5:

9.6 ↗	9.6 ↑	9.6 →	9.9 ↘	10.1 ↑
8.9 →	9.3 ↘	9.9 ↑	9.3 ↓	10.7 *

beste Teiler 63.5 (50.) 219.8 (45.) 257.5 (48.)

Trefferlage 0.57 mm rechts, 1.52 mm hoch

Streuwert 2.19, horizontal: 2.27, vertikal: 2.12

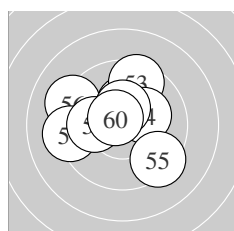

Serie 6:

10.5 *	10.3 *	9.5 ↑	10.2 *	9.4 ↘
9.2 ↘	9.2 ←	10.0 ←	10.4 *	10.6 *

beste Teiler 82.0 (60.) 119.8 (51.) 138.0 (59.)

Trefferlage 0.47 mm links, 0.73 mm hoch

Streuwert 2.04, horizontal: 2.36, vertikal: 1.66

Meyton Elektronik

LG 60 ZR – Wertung – Frauen

StandNr: 118

Schauer,, Arabella #70113057

StartNr: 48

17. März 2019 14:35

SG_Roppen

Unterschrift des Schützen

Meyton Elektronik

Ergebnis: **618.4** (590)
 Serien: 101.3 103.1 103.8 103.4 102.9 103.9
 Zähler: 50 10 0 0 0 0 0 0 0
 Innenzehner: 42
 weiteste: 409 (41), 357 (8), 335 (4)
 beste Teiler 5.0 (54.) 30.0 (1.) 52.4 (59.)
 Trefferlage 0.22 mm links, 0.33 mm hoch
 Streuwert 1.27, horizontal: 1.54, vertikal: 0.91

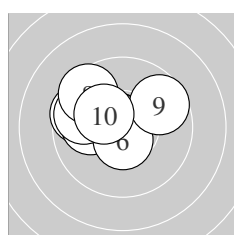
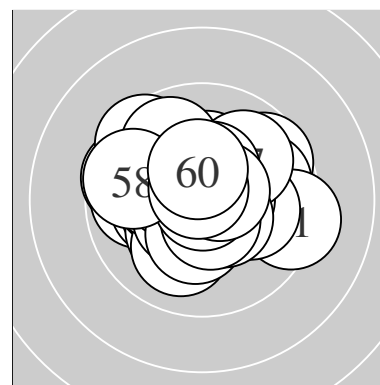

Serie 1:
 10.8 * 10.4 * 10.7 * 9.6 ↖ 10.0 ←
 10.6 * 9.7 ↖ 9.5 ↖ 9.7 ↗ 10.3 *
 beste Teiler 30.0 (1.) 75.1 (3.) 94.0 (6.)
 Trefferlage 1.19 mm links, 0.73 mm hoch
 Streuwert 1.43, horizontal: 1.79, vertikal: 0.93

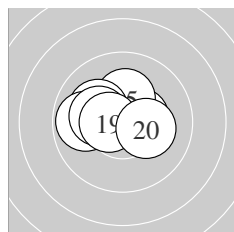

Serie 2:
 10.5 * 10.6 * 10.6 * 10.4 * 10.2 *
 10.1 ↖ 9.8 ← 10.2 * 10.5 * 10.2 *
 beste Teiler 78.4 (12.) 90.1 (13.) 101.0 (19.)
 Trefferlage 0.28 mm links, 0.43 mm hoch
 Streuwert 1.16, horizontal: 1.53, vertikal: 0.61

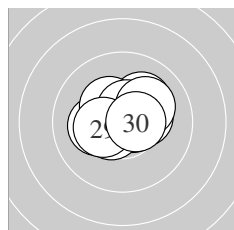

Serie 3:
 10.7 * 10.2 * 10.1 ↗ 10.3 * 10.6 *
 10.3 * 10.1 ↗ 10.5 * 10.4 * 10.6 *
 beste Teiler 73.0 (21.) 96.7 (25.) 99.0 (30.)
 Trefferlage 0.15 mm rechts, 0.39 mm hoch
 Streuwert 1.08, horizontal: 1.33, vertikal: 0.75

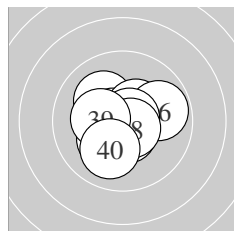

Serie 4:
 10.1 ↖ 10.2 * 10.6 * 10.7 * 10.4 *
 9.8 → 10.7 * 10.6 * 10.3 * 10.0 ↙
 beste Teiler 56.4 (37.) 75.2 (34.) 80.0 (38.)
 Trefferlage 0.08 mm links, 0.10 mm tief
 Streuwert 1.24, horizontal: 1.35, vertikal: 1.11

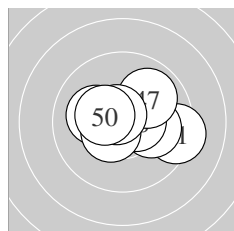

Serie 5:
 9.3 → 10.7 * 10.7 * 10.1 ↖ 10.1 →
 10.5 * 9.9 ↗ 10.5 * 10.7 * 10.4 *
 beste Teiler 54.1 (42.) 61.0 (43.) 70.4 (49.)
 Trefferlage 0.34 mm rechts, 0.18 mm hoch
 Streuwert 1.42, horizontal: 1.86, vertikal: 0.77

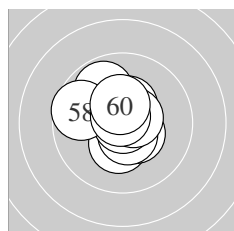

Serie 6:
 10.3 * 10.5 * 10.6 * 10.9 * 9.8 ↖
 10.4 * 10.6 * 9.7 ↖ 10.7 * 10.4 *
 beste Teiler 5.0 (54.) 52.4 (59.) 89.4 (57.)
 Trefferlage 0.26 mm links, 0.36 mm hoch
 Streuwert 1.20, horizontal: 1.20, vertikal: 1.20

Meyton Elektronik

LG 60 ZR – Wertung – Frauen
StandNr: 119
Ungerank,, Lisa #70817124

StartNr: 49
17. März 2019 14:08
SG_Zell_am_Ziller

Unterschrift des Schützen

Meyton Elektronik

Ergebnis:	599.5	(573)							
Serien:	99.8	103.2	101.7	97.8	98.6	98.4			
Zähler:	36	22	1	1	0	0	0	0	0
Innenzehner:	26								
weiteste:	790 (38), 557 (6), 478 (41)								
beste Teiler	40.3 (23.) 44.2 (18.) 47.8 (50.)								
Trefferlage	0.33 mm links, 0.12 mm hoch								
Streuwert	1.96, horizontal: 2.27, vertikal: 1.59								

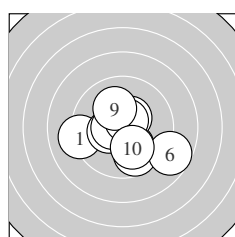
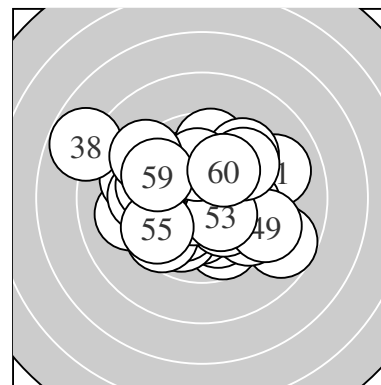

Serie 1:					
	9.2 ←	10.4 *	9.7 ↘	10.1 ↘	10.5 *
	8.7 ↘	10.5 *	10.6 *	10.1 ↑	10.0 ↘
beste Teiler	79.4 (8.) 102.0 (7.) 122.2 (5.)				
Trefferlage	0.16 mm rechts, 0.73 mm tief				
Streuwert	2.04, horizontal: 2.38, vertikal: 1.62				

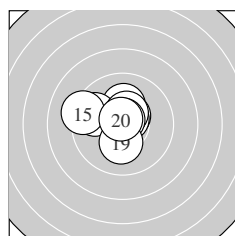

Serie 2:					
	10.2 *	10.5 *	9.7 ↖	10.7 *	9.3 ↖
	10.6 *	10.5 *	10.8 *	10.2 *	10.7 *
beste Teiler	44.2 (18.) 54.0 (20.) 71.5 (14.)				
Trefferlage	0.53 mm links, 0.66 mm hoch				
Streuwert	1.32, horizontal: 1.59, vertikal: 0.99				

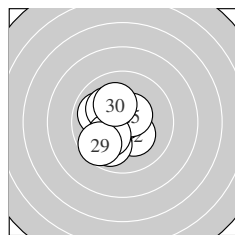

Serie 3:					
	9.9 ↖	10.3 *	10.8 *	10.1 ✓	10.5 *
	9.9 ✓	10.1 ↖	10.2 *	9.7 ✓	10.2 *
beste Teiler	40.3 (23.) 111.9 (25.) 170.5 (22.)				
Trefferlage	0.90 mm links, 0.37 mm tief				
Streuwert	1.40, horizontal: 1.23, vertikal: 1.56				

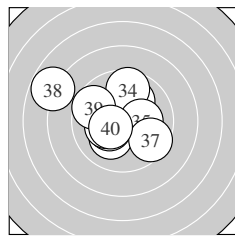

Serie 4:					
	10.0 ↗	10.1 ✓	10.3 *	9.6 ↑	10.2 *
	10.2 *	9.6 ↘	7.8 ↖	9.6 ↖	10.4 *
beste Teiler	138.6 (40.) 157.9 (33.) 176.7 (36.)				
Trefferlage	0.92 mm links, 0.44 mm hoch				
Streuwert	2.44, horizontal: 2.85, vertikal: 1.94				

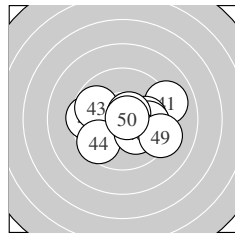

Serie 5:					
	9.0 →	9.5 ←	9.8 ↖	9.6 ✓	10.0 →
	9.9 →	10.6 *	10.2 *	9.2 ↘	10.8 *
beste Teiler	47.8 (50.) 85.1 (47.) 193.7 (48.)				
Trefferlage	0.70 mm rechts, 0.20 mm tief				
Streuwert	2.19, horizontal: 2.82, vertikal: 1.28				

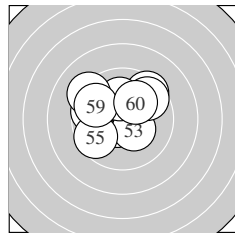

Serie 6:					
	10.6 *	9.7 ↖	10.3 *	9.5 ↗	9.6 ↖
	9.6 ↗	10.1 ↑	9.2 ↖	9.7 ↖	10.1 ↗
beste Teiler	85.0 (51.) 155.7 (53.) 208.0 (57.)				
Trefferlage	0.53 mm links, 0.97 mm hoch				
Streuwert	2.02, horizontal: 2.36, vertikal: 1.61				

Meyton Elektronik

LG 60 ZR – Wertung – Frauen

StandNr: 120

Klingenschmid,, Anna-Lena #70103076

StartNr: 50

17. März 2019 14:09

SG_Imst

Unterschrift des Schützen

Meyton Elektronik

Ergebnis:	609.9	(585)						
Serien:	100.7	101.4	102.5	101.9	101.4	102.0		
Zähler:	46	13	1	0	0	0	0	0
Innenzehner:	36							
weiteste:	651	(60),	441	(10),	397	(38)		
beste Teiler	11.4	(55.)	35.1	(53.)	61.0	(7.)		
Trefferlage	0.86	mm	rechts,	0.35	mm	hoch		
Streuwert	1.46,	horizontal:	1.49,	vertikal:	1.43			

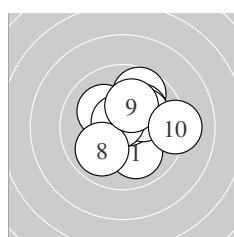
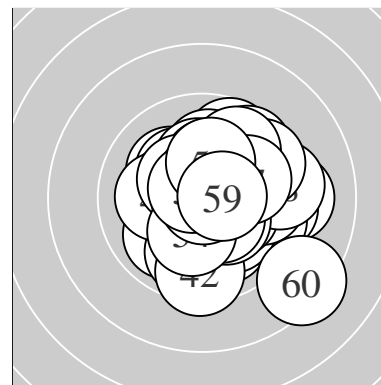

Serie 1:						
	10.0 ↘	9.7 ↗	10.1 ↗	10.6 *	10.2 *	
	10.1 ↘	10.7 *	9.9 ↙	10.2 *	9.2 →	
beste Teiler	61.0	(7.)	81.5	(4.)	195.0	(9.)
Trefferlage	0.76	mm	rechts,	0.56	mm	hoch
Streuwert	1.66,	horizontal:	1.78,	vertikal:	1.53	

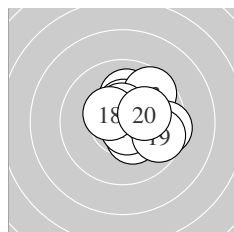

Serie 2:						
	10.1 ↑	10.4 *	9.6 ↗	10.5 *	10.3 *	
	10.7 *	9.5 →	10.4 *	9.7 →	10.2 *	
beste Teiler	63.4	(16.)	103.3	(14.)	129.7	(18.)
Trefferlage	1.12	mm	rechts,	0.50	mm	hoch
Streuwert	1.40,	horizontal:	1.50,	vertikal:	1.30	

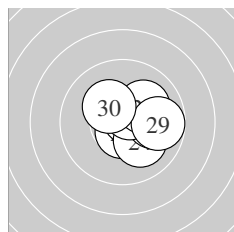

Serie 3:						
	10.6 *	10.2 *	10.7 *	10.1 ↘	10.2 *	
	9.9 →	10.6 *	10.1 ↗	9.8 →	10.3 *	
beste Teiler	66.5	(23.)	80.2	(21.)	97.4	(27.)
Trefferlage	1.21	mm	rechts,	0.23	mm	hoch
Streuwert	1.08,	horizontal:	1.23,	vertikal:	0.91	

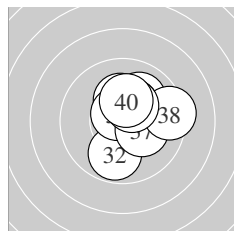

Serie 4:						
	10.0 ↗	9.8 ↓	10.5 *	10.2 *	10.4 *	
	10.7 *	10.2 *	9.4 →	10.4 *	10.3 *	
beste Teiler	75.4	(36.)	124.1	(33.)	150.7	(39.)
Trefferlage	0.75	mm	rechts,	0.69	mm	hoch
Streuwert	1.38,	horizontal:	1.34,	vertikal:	1.42	

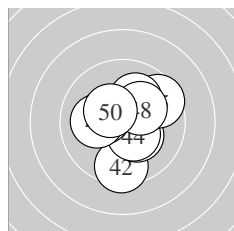

Serie 5:						
	10.5 *	9.5 ↓	10.3 *	10.4 *	9.6 ↗	
	10.1 ↗	10.3 *	10.2 *	10.1 ←	10.4 *	
beste Teiler	118.9	(41.)	137.3	(44.)	140.1	(50.)
Trefferlage	0.39	mm	rechts,	0.06	mm	hoch
Streuwert	1.62,	horizontal:	1.58,	vertikal:	1.66	

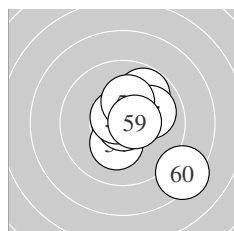

Serie 6:						
	9.8 ↗	10.5 *	10.8 *	10.3 *	10.9 *	
	10.7 *	10.0 →	10.2 *	10.5 *	8.3 ↘	
beste Teiler	11.4	(55.)	35.1	(53.)	68.5	(56.)
Trefferlage	0.92	mm	rechts,	0.08	mm	hoch
Streuwert	1.79,	horizontal:	1.71,	vertikal:	1.86	

Meyton Elektronik

LG 60 ZR – Wertung – Frauen

StandNr: 121

Sailer,, Manuela #70503070

StartNr: 51

17. März 2019 14:22

SG_Kappl

Unterschrift des Schützen

Meyton Elektronik

Ergebnis: **595.3** (568)
 Serien: 100.2 93.7 99.0 98.5 102.4 101.5
 Zähler: 32 25 2 1 0 0 0 0 0
 Innenzehner: 24
 weiteste: 761 (17), 550 (21), 520 (18)
 beste Teiler 54.4 (57.) 64.4 (4.) 65.0 (48.)
 Trefferlage 0.04 mm links, 0.48 mm hoch
 Streuwert 2.08, horizontal: 2.29, vertikal: 1.83

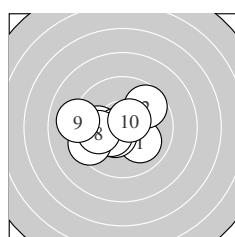
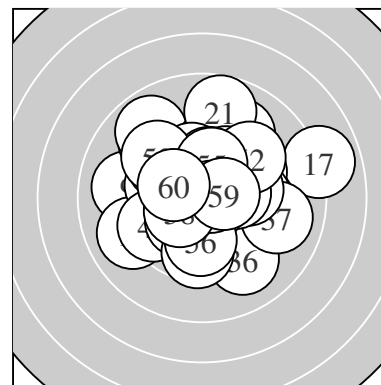

Serie 1:
 10.0 ↘ 9.7 ↗ 9.9 ← 10.7 * 10.5 *
 10.4 * 9.4 ← 9.9 ← 9.1 ← 10.6 *
 beste Teiler 64.4 (4.) 98.2 (10.) 117.7 (5.)
 Trefferlage 1.07 mm links, 0.21 mm tief
 Streuwert 1.79, horizontal: 2.26, vertikal: 1.14

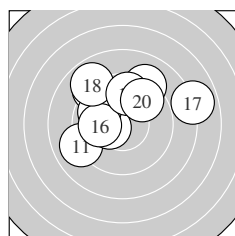

Serie 2:
 9.0 ← 9.1 ↗ 9.1 ↘ 10.4 * 9.9 ↖
 10.0 ← 7.9 → 8.9 ↘ 9.7 ↑ 9.7 ↗
 beste Teiler 139.4 (14.) 236.2 (16.) 272.3 (15.)
 Trefferlage 0.44 mm links, 1.81 mm hoch
 Streuwert 2.90, horizontal: 3.52, vertikal: 2.11

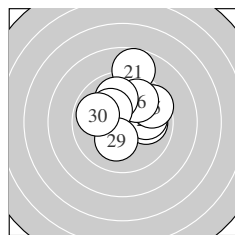

Serie 3:
 8.8 ↑ 10.0 → 10.5 * 10.0 → 9.6 ↗
 9.9 ↗ 9.9 ↑ 10.2 * 10.2 * 9.9 ←
 beste Teiler 109.2 (23.) 176.0 (28.) 190.7 (29.)
 Trefferlage 0.59 mm rechts, 1.32 mm hoch
 Streuwert 1.85, horizontal: 1.84, vertikal: 1.87

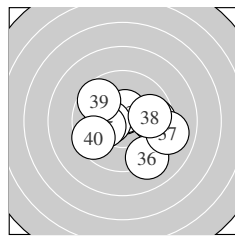

Serie 4:
 10.6 * 9.6 → 10.5 * 10.4 * 10.2 *
 9.1 ↘ 9.0 → 9.8 → 9.7 ↘ 9.6 ←
 beste Teiler 87.5 (31.) 105.0 (33.) 138.5 (34.)
 Trefferlage 0.48 mm rechts, 0.27 mm tief
 Streuwert 2.24, horizontal: 2.69, vertikal: 1.66

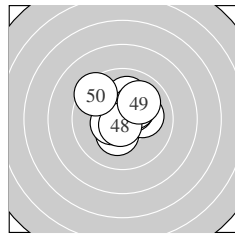

Serie 5:
 10.3 * 10.6 * 10.1 → 10.5 * 10.4 *
 10.1 ↑ 10.3 * 10.7 * 10.0 ↗ 9.4 ↖
 beste Teiler 65.0 (48.) 90.7 (42.) 119.6 (44.)
 Trefferlage 0.08 mm rechts, 0.59 mm hoch
 Streuwert 1.41, horizontal: 1.48, vertikal: 1.34

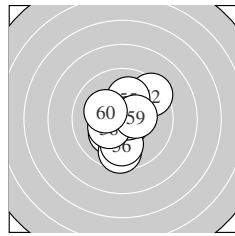

Serie 6:
 10.2 * 9.4 ↗ 9.6 ↓ 10.7 * 10.1 ↑
 9.9 ↓ 10.7 * 10.3 * 10.4 * 10.2 *
 beste Teiler 54.4 (57.) 69.4 (54.) 137.2 (59.)
 Trefferlage 0.10 mm rechts, 0.30 mm tief
 Streuwert 1.67, horizontal: 1.42, vertikal: 1.88

LG 60 ZR – Wertung – Frauen

StandNr: 122

Oberhofer,, Julia #70406045

StartNr: 52

17. März 2019 14:02

SG_Bruckhäusl / SG Bruckhäusl 2

Unterschrift des Schützen

Meyton Elektronik

Ergebnis: **599.4** (572)

Serien: 97.9 101.9 99.3 99.4 100.4 100.5

Zähler: 36 20 4 0 0 0 0 0 0 0

Innenzehner: 28

weiteste: 535 (31), 533 (9), 522 (51)

beste Teiler 44.5 (46.) 53.4 (16.) 54.4 (12.)

Trefferlage 0.37 mm links, 0.54 mm hoch

Streuwert 1.88, horizontal: 1.99, vertikal: 1.75

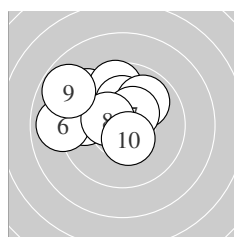
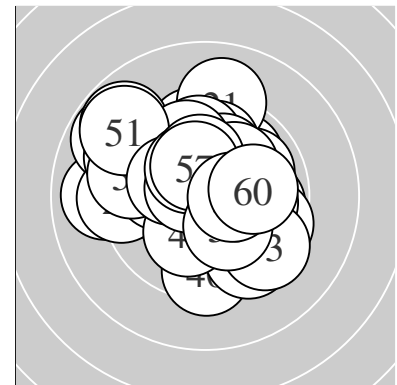

Serie 1:

9.7 ←	9.4 ↘	9.7 ↑	10.2 *	9.9 ↗
8.9 ←	10.4 *	10.4 *	8.8 ↘	10.5 *

beste Teiler 121.4 (10.) 130.5 (7.) 135.3 (8.)

Trefferlage 1.45 mm links, 1.33 mm hoch

Streuwert 1.91, horizontal: 2.33, vertikal: 1.37

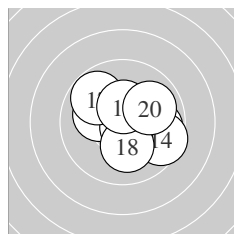

Serie 2:

9.8 →	10.7 *	10.1 ↖	9.6 ↘	10.7 *
10.7 *	9.8 ↘	10.2 *	10.4 *	9.9 ↗

beste Teiler 53.4 (16.) 54.4 (12.) 62.3 (15.)

Trefferlage 0.58 mm rechts, 0.15 mm hoch

Streuwert 1.54, horizontal: 1.79, vertikal: 1.23

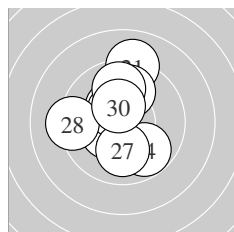

Serie 3:

9.0 ↑	9.9 ↑	10.3 *	9.8 ↘	10.3 *
10.5 *	10.0 ↓	9.3 ←	9.8 ↑	10.4 *

beste Teiler 121.4 (26.) 139.2 (30.) 151.4 (23.)

Trefferlage 0.46 mm links, 0.80 mm hoch

Streuwert 1.95, horizontal: 1.60, vertikal: 2.25

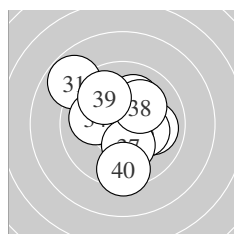

Serie 4:

8.8 ↘	10.7 *	10.0 →	10.0 ←	10.1 ↗
10.2 *	10.2 *	10.1 ↗	9.9 ↘	9.4 ↓

beste Teiler 56.5 (32.) 179.6 (36.) 184.3 (37.)

Trefferlage 0.13 mm links, 0.32 mm hoch

Streuwert 2.06, horizontal: 2.00, vertikal: 2.11

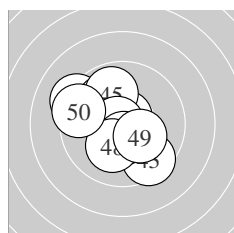

Serie 5:

9.2 ↘	10.0 ↘	9.5 ↘	10.7 *	9.9 ↑
10.8 *	10.5 *	10.2 *	10.2 *	9.4 ←

beste Teiler 44.5 (46.) 61.8 (44.) 119.4 (47.)

Trefferlage 0.74 mm links, 0.11 mm hoch

Streuwert 1.88, horizontal: 1.95, vertikal: 1.81

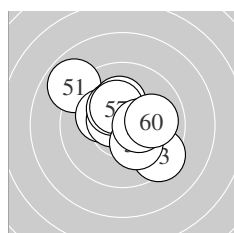

Serie 6:

8.9 ↘	10.2 *	9.4 ↘	10.6 *	10.3 *
10.2 *	10.3 *	10.2 *	10.4 *	10.0 →

beste Teiler 89.4 (54.) 137.1 (59.) 158.1 (55.)

Trefferlage 0.01 mm links, 0.54 mm hoch

Streuwert 1.88, horizontal: 2.09, vertikal: 1.66

Meyton Elektronik

LG 60 ZR – Wertung – Frauen

StandNr: 123

Gstrein., Sabrina #70103056

StartNr: 53

17. März 2019 14:02

SG_Imst

Unterschrift des Schützen

Meyton Elektronik

Ergebnis: **616.0** (588)
 Serien: 102.7 101.4 101.5 105.2 103.8 101.4
 Zähler: 49 10 1 0 0 0 0 0 0
 Innenzehner: 43
 weiteste: 501 (21), 417 (54), 382 (15)
 beste Teiler 23.4 (39.) 29.0 (31.) 37.6 (49.)
 Trefferlage 0.52 mm rechts, 0.63 mm hoch
 Streuwert 1.27, horizontal: 1.55, vertikal: 0.90

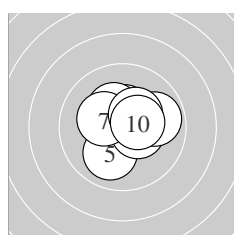
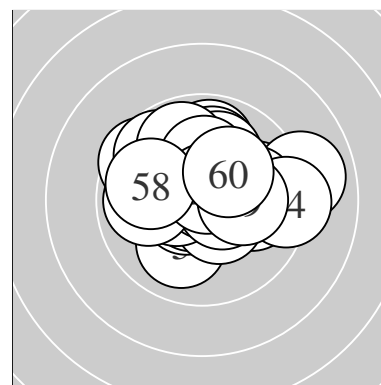

Serie 1:
 10.4 * 10.3 * 10.2 * 10.4 * 10.0 ↙
 10.4 * 10.3 * 9.9 → 10.4 * 10.4 *
 beste Teiler 127.8 (1.) 129.9 (10.) 130.0 (6.)
 Trefferlage 0.63 mm rechts, 0.41 mm hoch
 Streuwert 1.20, horizontal: 1.36, vertikal: 1.02

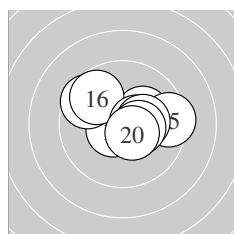

Serie 2:
 10.2 * 10.6 * 9.6 ↘ 10.2 * 9.4 →
 9.7 ↘ 10.5 * 10.3 * 10.4 * 10.5 *
 beste Teiler 91.0 (12.) 107.5 (20.) 116.1 (17.)
 Trefferlage 0.63 mm rechts, 0.44 mm hoch
 Streuwert 1.58, horizontal: 2.01, vertikal: 0.96

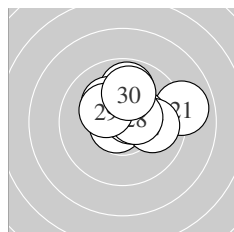

Serie 3:
 8.9 → 10.7 * 9.9 ↑ 10.6 * 10.2 *
 10.4 * 10.0 → 10.5 * 10.3 * 10.0 ↑
 beste Teiler 58.3 (22.) 79.3 (24.) 115.1 (28.)
 Trefferlage 0.83 mm rechts, 0.94 mm hoch
 Streuwert 1.49, horizontal: 1.84, vertikal: 1.03

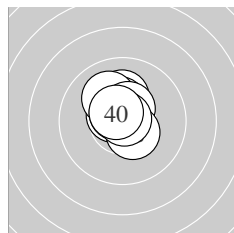

Serie 4:
 10.8 * 10.2 * 10.6 * 10.4 * 10.1 ↘
 10.5 * 10.6 * 10.5 * 10.9 * 10.6 *
 beste Teiler 23.4 (39.) 29.0 (31.) 82.6 (37.)
 Trefferlage 0.17 mm links, 0.76 mm hoch
 Streuwert 0.74, horizontal: 0.59, vertikal: 0.87

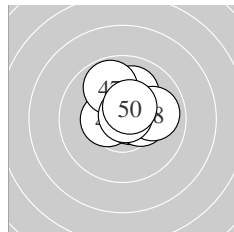

Serie 5:
 10.5 * 10.0 ↑ 10.6 * 10.6 * 10.7 *
 10.4 * 9.8 ↘ 9.9 → 10.8 * 10.5 *
 beste Teiler 37.6 (49.) 67.4 (45.) 86.1 (43.)
 Trefferlage 0.56 mm rechts, 0.72 mm hoch
 Streuwert 1.01, horizontal: 1.08, vertikal: 0.93

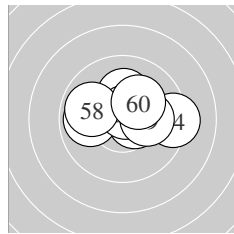

Serie 6:
 10.3 * 10.5 * 9.9 ← 9.3 → 10.3 *
 10.2 * 10.7 * 9.9 ↘ 10.1 → 10.2 *
 beste Teiler 62.2 (57.) 102.1 (52.) 151.3 (55.)
 Trefferlage 0.68 mm rechts, 0.49 mm hoch
 Streuwert 1.54, horizontal: 2.06, vertikal: 0.70

Meyton Elektronik

LG 60 ZR – Wertung – Frauen

StandNr: 124

Stefani,, Franziska #70113064

StartNr: 54

17. März 2019 14:37

SG_Roppen / SG Roppen 1

Unterschrift des Schützen

Meyton Elektronik

Ergebnis: **620.5** (591)
 Serien: 102.5 103.0 104.2 103.2 101.7 105.9
 Zähler: 51 9 0 0 0 0 0 0 0 0
 Innenzehner: 41
 weiteste: 370 (4), 324 (42), 306 (33)
 beste Teiler 11.1 (59.) 15.2 (58.) 17.2 (25.)
 Trefferlage 0.00 mm , 0.22 mm hoch
 Streuwert 1.26, horizontal: 1.38, vertikal: 1.11

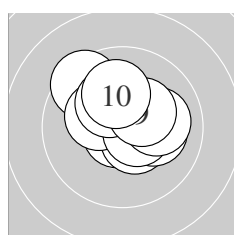
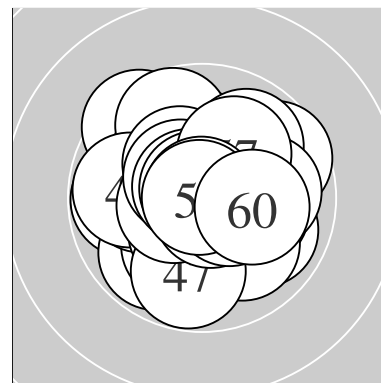

Serie 1:
 10.7 * 10.5 * 10.2 * 9.5 ↘ 10.3 *
 10.6 * 10.2 * 10.1 → 10.3 * 10.1 ↑
 beste Teiler 53.1 (1.) 100.2 (6.) 113.8 (2.)
 Trefferlage 0.15 mm rechts, 0.67 mm hoch
 Streuwert 1.38, horizontal: 1.53, vertikal: 1.20

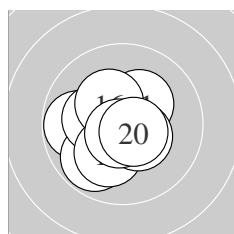

Serie 2:
 10.3 * 9.8 ← 10.7 * 9.8 ↙ 10.3 *
 10.3 * 10.1 ↙ 10.4 * 10.7 * 10.6 *
 beste Teiler 65.1 (19.) 65.4 (13.) 86.8 (20.)
 Trefferlage 0.61 mm links, 0.25 mm tief
 Streuwert 1.24, horizontal: 1.31, vertikal: 1.17

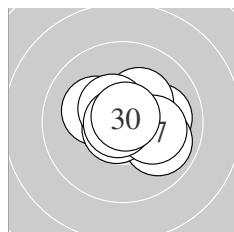

Serie 3:
 10.2 * 10.0 → 9.9 ↘ 10.3 * 10.9 *
 10.7 * 10.1 → 10.5 * 10.8 * 10.8 *
 beste Teiler 17.2 (25.) 31.7 (29.) 40.7 (30.)
 Trefferlage 0.48 mm rechts, 0.12 mm hoch
 Streuwert 1.11, horizontal: 1.37, vertikal: 0.76

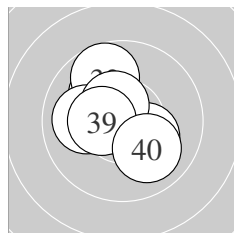

Serie 4:
 10.1 ↘ 10.8 * 9.7 ↗ 10.8 * 10.7 *
 10.2 * 10.0 ← 10.5 * 10.4 * 10.0 ↘
 beste Teiler 48.3 (34.) 49.2 (32.) 52.4 (35.)
 Trefferlage 0.49 mm links, 0.35 mm hoch
 Streuwert 1.26, horizontal: 1.22, vertikal: 1.29

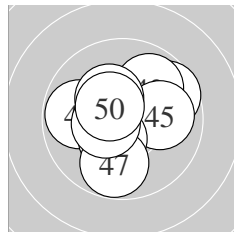

Serie 5:
 9.8 ← 9.7 ↗ 9.9 ↗ 10.8 * 10.0 →
 10.4 * 9.8 ↓ 10.3 * 10.5 * 10.5 *
 beste Teiler 26.9 (44.) 114.0 (49.) 117.3 (50.)
 Trefferlage 0.00 mm , 0.17 mm hoch
 Streuwert 1.62, horizontal: 1.78, vertikal: 1.44

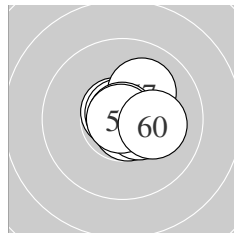

Serie 6:
 10.3 * 10.7 * 10.7 * 10.5 * 10.8 *
 10.8 * 10.1 ↗ 10.9 * 10.9 * 10.2 *
 beste Teiler 11.1 (59.) 15.2 (58.) 28.6 (55.)
 Trefferlage 0.52 mm rechts, 0.26 mm hoch
 Streuwert 0.75, horizontal: 0.80, vertikal: 0.69

Meyton Elektronik

LG 60 ZR – Wertung – **Frauen**

StartNr: 55

StandNr: 125

17. März 2019 14:09

Embacher,, Sonja #70420014

SG_Söller_Sportschützen / Söller Sportschützen 1

Unterschrift des Schützen

Meyton Elektronik

Ergebnis:	621.2	(592)			
Serien:	103.9	103.9	103.6	101.8	103.6 104.4
Zähler:	52	8	0	0	0 0 0 0 0
Innenzehner:	43				
weiteste:	308	(56), 305	(28), 277	(33)	
beste Teiler	16.1	(13.) 32.3	(1.) 38.8	(47.)	
Trefferlage	0.18 mm	links, 0.04 mm	hoch		
Streuwert	1.18,	horizontal: 1.24,	vertikal: 1.12		

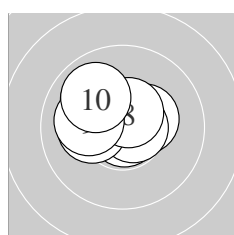
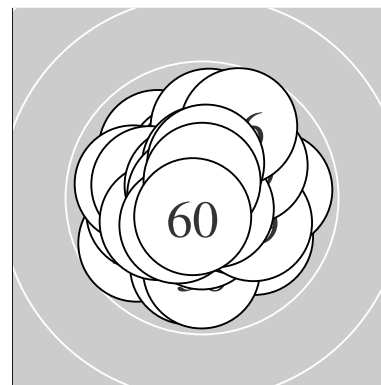

Serie 1:	10.8 *	10.5 *	10.7 *	10.0 ↘	10.4 *
	10.7 *	10.2 *	10.6 *	10.1 ←	9.9 ↘
beste Teiler	32.3	(1.) 55.8	(3.) 68.0	(6.)	
Trefferlage	0.62 mm	links, 0.60 mm	hoch		
Streuwert	1.02,	horizontal: 1.24,	vertikal: 0.73		

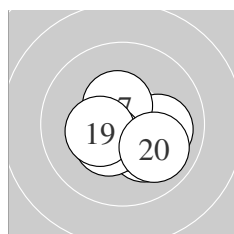

Serie 2:	10.1 ↘	10.6 *	10.9 *	10.6 *	10.0 →
	10.5 *	10.5 *	10.4 *	10.3 *	10.0 ↘
beste Teiler	16.1	(13.) 88.8	(12.) 97.0	(14.)	
Trefferlage	0.19 mm	rechts, 0.53 mm	tief		
Streuwert	1.08,	horizontal: 1.32,	vertikal: 0.79		

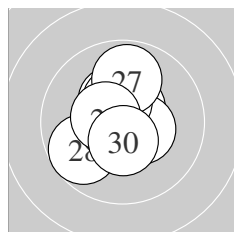

Serie 3:	10.7 *	10.6 *	10.4 *	10.5 *	10.4 *
	10.4 *	9.9 ↑	9.7 ↙	10.5 *	10.5 *
beste Teiler	54.1	(21.) 100.3	(22.) 113.8	(29.)	
Trefferlage	0.32 mm	links, 0.25 mm	hoch		
Streuwert	1.21,	horizontal: 1.07,	vertikal: 1.34		

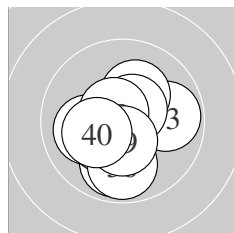

Serie 4:	9.9 ↓	10.3 *	9.8 →	10.2 *	10.6 *
	9.8 ↓	10.0 ←	10.6 *	10.4 *	10.2 *
beste Teiler	78.5	(38.) 96.6	(35.) 127.0	(39.)	
Trefferlage	0.19 mm	links, 0.57 mm	tief		
Streuwert	1.42,	horizontal: 1.40,	vertikal: 1.44		

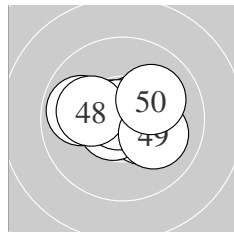

Serie 5:	10.4 *	10.4 *	10.5 *	9.9 ←	10.6 *
	10.7 *	10.8 *	10.1 ←	10.1 →	10.1 →
beste Teiler	38.8	(47.) 72.9	(46.) 80.9	(45.)	
Trefferlage	0.08 mm	rechts, 0.18 mm	hoch		
Streuwert	1.23,	horizontal: 1.60,	vertikal: 0.67		

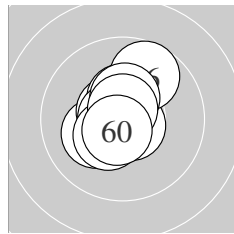

Serie 6:	10.2 *	10.6 *	10.4 *	10.7 *	10.7 *
	9.7 ↗	10.4 *	10.4 *	10.7 *	10.6 *
beste Teiler	63.7	(54.) 64.0	(59.) 66.0	(55.)	
Trefferlage	0.23 mm	links, 0.34 mm	hoch		
Streuwert	1.04,	horizontal: 0.85,	vertikal: 1.20		

Meyton Elektronik

LG 60 ZR – Wertung – Frauen

StandNr: 126

Auer,, Marie-Theres #70113006

StartNr: 56

17. März 2019 14:16

SG_Roppen / SG Roppen 1

Unterschrift des Schützen

Meyton Elektronik

Ergebnis: **602.7** (575)
 Serien: 102.5 97.4 101.3 102.6 99.2 99.7
 Zähler: 35 25 0 0 0 0 0 0 0 0
 Innenzehner: 28
 weiteste: 492 (45), 443 (14), 442 (54)
 beste Teiler 57.5 (5.) 59.5 (31.) 71.1 (51.)
 Trefferlage 0.24 mm links, 0.42 mm hoch
 Streuwert 1.79, horizontal: 1.93, vertikal: 1.64

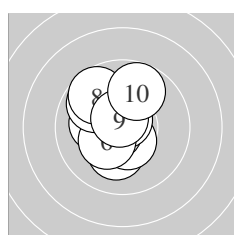
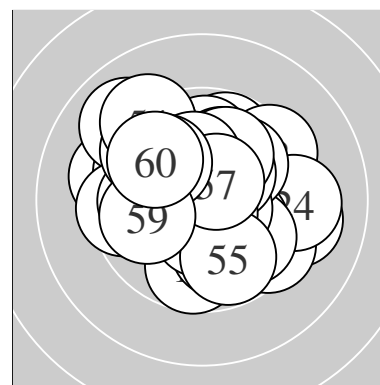

Serie 1:
 10.2 * 10.2 * 10.5 * 10.6 * 10.7 *
 10.3 * 9.8 ↘ 9.7 ↘ 10.7 * 9.8 ↗
 beste Teiler 57.5 (5.) 73.0 (9.) 78.7 (4.)
 Trefferlage 0.71 mm links, 0.43 mm hoch
 Streuwert 1.35, horizontal: 1.10, vertikal: 1.56

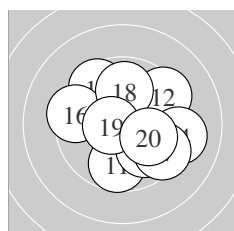

Serie 2:
 9.7 ↓ 9.4 ↗ 9.9 ↘ 9.2 → 9.6 ↘
 9.5 ← 9.5 ↘ 9.9 ↑ 10.6 * 10.1 →
 beste Teiler 88.5 (19.) 225.8 (20.) 255.6 (13.)
 Trefferlage 0.75 mm rechts, 0.06 mm tief
 Streuwert 2.33, horizontal: 2.54, vertikal: 2.10

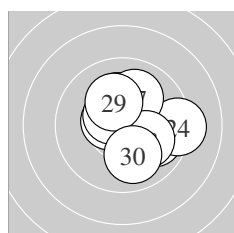

Serie 3:
 10.7 * 9.9 → 10.5 * 9.2 → 10.2 *
 10.5 * 10.0 ↗ 10.1 ↘ 10.2 * 10.0 ↓
 beste Teiler 72.8 (21.) 106.6 (23.) 114.0 (26.)
 Trefferlage 0.78 mm rechts, 0.17 mm hoch
 Streuwert 1.58, horizontal: 1.69, vertikal: 1.46

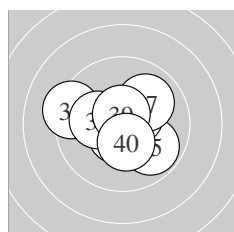

Serie 4:
 10.7 * 10.5 * 9.3 ← 10.6 * 9.8 ↘
 10.5 * 10.0 ↗ 10.2 * 10.6 * 10.4 *
 beste Teiler 59.5 (31.) 78.6 (39.) 94.4 (34.)
 Trefferlage 0.07 mm links, 0.12 mm hoch
 Streuwert 1.50, horizontal: 1.82, vertikal: 1.10

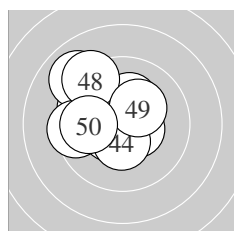

Serie 5:
 10.5 * 10.5 * 9.7 ↘ 10.4 * 9.0 ↘
 10.2 * 9.5 ← 9.2 ↘ 10.3 * 9.9 ←
 beste Teiler 111.0 (42.) 116.6 (41.) 135.2 (44.)
 Trefferlage 1.33 mm links, 0.83 mm hoch
 Streuwert 1.81, horizontal: 1.91, vertikal: 1.70

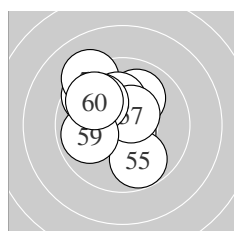

Serie 6:
 10.7 * 9.6 ↘ 10.0 ↗ 9.2 ↘ 9.8 ↓
 10.2 * 10.5 * 10.0 ↘ 9.9 ← 9.8 ↘
 beste Teiler 71.1 (51.) 107.6 (57.) 192.0 (56.)
 Trefferlage 0.86 mm links, 1.03 mm hoch
 Streuwert 1.74, horizontal: 1.61, vertikal: 1.86

Meyton Elektronik

LG 60 ZR – Wertung – Frauen

StandNr: 127

Klingler,, Lea #70410003

StartNr: 57

17. März 2019 14:06

SG_Kramsach

Unterschrift des Schützen

Meyton Elektronik

Ergebnis: **592.1** (562)
 Serien: 96.6 96.4 98.4 101.7 100.9 98.1
 Zähler: 29 25 5 1 0 0 0 0 0
 Innenzehner: 20
 weiteste: 758 (11), 667 (60), 659 (10)
 beste Teiler 16.4 (55.) 22.4 (2.) 41.1 (36.)
 Trefferlage 0.62 mm links, 0.83 mm hoch
 Streuwert 2.13, horizontal: 2.52, vertikal: 1.66

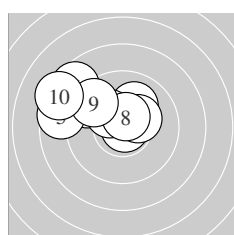
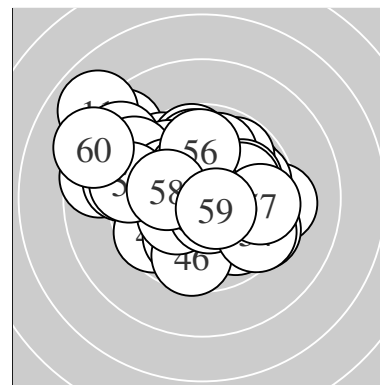

Serie 1:
 9.4 ↘ 10.9 * 10.1 ↗ 10.3 * 8.6 ←
 8.6 ↘ 10.3 * 10.5 * 9.6 ↘ 8.3 ↘
 beste Teiler 22.4 (2.) 102.7 (8.) 162.4 (7.)
 Trefferlage 2.01 mm links, 1.73 mm hoch
 Streuwert 2.12, horizontal: 2.77, vertikal: 1.14

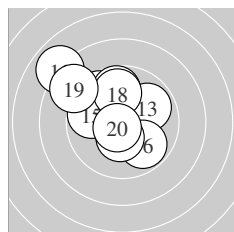

Serie 2:
 7.9 ↘ 9.6 ↘ 9.9 ↗ 9.7 ↑ 9.8 ←
 9.8 ↘ 10.4 * 9.9 ↑ 8.7 ↘ 10.7 *
 beste Teiler 72.8 (20.) 145.0 (17.) 267.3 (13.)
 Trefferlage 1.30 mm links, 1.43 mm hoch
 Streuwert 2.41, horizontal: 2.59, vertikal: 2.23

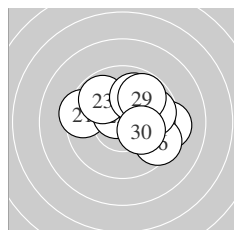

Serie 3:
 9.4 ← 10.6 * 9.8 ↘ 9.3 → 10.1 ↗
 9.5 ↘ 9.9 ↑ 9.8 → 9.8 ↗ 10.2 *
 beste Teiler 90.6 (22.) 188.1 (30.) 217.9 (25.)
 Trefferlage 1.05 mm rechts, 0.74 mm hoch
 Streuwert 1.96, horizontal: 2.42, vertikal: 1.35

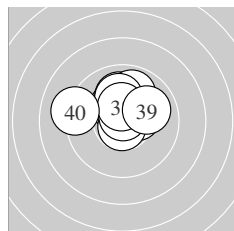

Serie 4:
 10.3 * 10.4 * 10.0 ↑ 9.9 ↑ 10.7 *
 10.8 * 10.1 ↑ 10.4 * 10.0 → 9.1 ←
 beste Teiler 41.1 (36.) 51.3 (35.) 133.4 (38.)
 Trefferlage 0.16 mm links, 1.20 mm hoch
 Streuwert 1.41, horizontal: 1.75, vertikal: 0.96

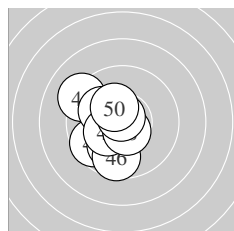

Serie 5:
 9.2 ↘ 9.6 ↘ 10.0 ↓ 10.4 * 10.1 ↘
 9.6 ↓ 10.3 * 10.6 * 10.8 * 10.3 *
 beste Teiler 48.0 (49.) 93.5 (48.) 146.7 (44.)
 Trefferlage 1.25 mm links, 0.51 mm tief
 Streuwert 1.52, horizontal: 1.25, vertikal: 1.76

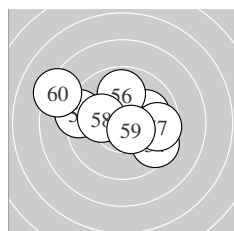

Serie 6:
 9.9 → 9.3 ← 10.0 → 9.5 ↘ 10.9 *
 9.9 ↑ 9.6 → 10.1 ← 10.6 * 8.3 ↘
 beste Teiler 16.4 (55.) 98.4 (59.) 201.0 (58.)
 Trefferlage 0.04 mm links, 0.41 mm hoch
 Streuwert 2.45, horizontal: 3.12, vertikal: 1.49

Meyton Elektronik

LG 60 ZR – Wertung – Frauen

StandNr: 128

Kathrein,, Barbara #70504004

StartNr: 58

17. März 2019 13:58

SG_Kaunertal

Unterschrift des Schützen

Meyton Elektronik