

Ergebnis: **410.3** (393)
 Serien: 101.8 102.9 102.8 102.8
 Zähler: 33 7 0 0 0 0 0 0 0 0
 Innenzehner: 26
 weiteste: 357 (6), 292 (37), 284 (9)
 beste Teiler 22.4 (7.) 29.7 (19.) 52.0 (27.)
 Trefferlage 0.30 mm rechts, 0.36 mm hoch
 Streuwert 1.32, horizontal: 1.45, vertikal: 1.16

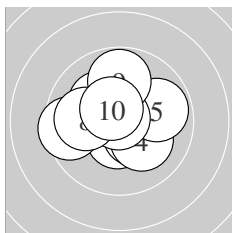

Serie 1:
 10.5 * 10.2 * 10.4 * 10.1 ↘ 9.9 →
 9.5 ← 10.9 * 10.0 ← 9.8 ↑ 10.5 *
 beste Teiler 22.4 (7.) 106.2 (10.) 113.9 (1.)
 Trefferlage 0.29 mm links, 0.23 mm hoch
 Streuwert 1.58, horizontal: 1.83, vertikal: 1.28

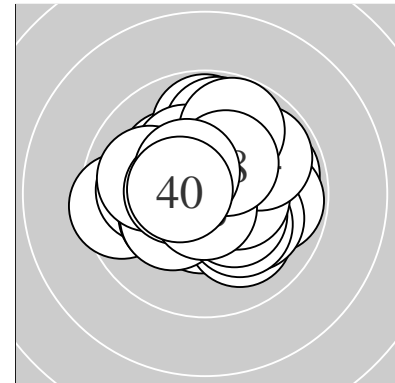
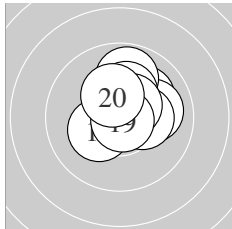

Serie 2:
 10.1 ↗ 10.0 → 10.6 * 10.3 * 9.8 ↑
 10.3 * 10.2 * 10.5 * 10.8 * 10.3 *
 beste Teiler 29.7 (19.) 92.1 (13.) 114.6 (18.)
 Trefferlage 0.56 mm rechts, 0.84 mm hoch
 Streuwert 1.08, horizontal: 1.10, vertikal: 1.07

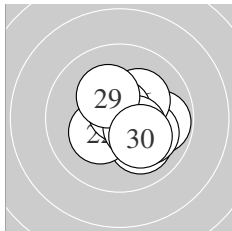

Serie 3:
 10.0 ↘ 10.3 * 10.7 * 9.8 → 10.1 ↘
 10.2 * 10.7 * 10.5 * 10.3 * 10.2 *
 beste Teiler 52.0 (27.) 62.3 (23.) 124.6 (28.)
 Trefferlage 0.80 mm rechts, 0.20 mm tief
 Streuwert 1.21, horizontal: 1.30, vertikal: 1.12

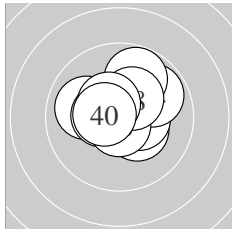

Serie 4:
 10.0 ↖ 10.3 * 10.4 * 9.8 ↗ 10.5 *
 10.7 * 9.8 ↑ 10.3 * 10.5 * 10.5 *
 beste Teiler 56.1 (36.) 108.6 (40.) 121.4 (35.)
 Trefferlage 0.15 mm rechts, 0.58 mm hoch
 Streuwert 1.28, horizontal: 1.47, vertikal: 1.07

Unterschrift des Schützen

Meyton Elektronik

Ergebnis: **393.8** (381)
 Serien: 96.6 97.7 99.6 99.9
 Zähler: 24 13 3 0 0 0 0 0 0 0
 Innenzehner: 12
 weiteste: 629 (13), 561 (1), 507 (9)
 beste Teiler 53.7 (37.) 68.0 (35.) 92.1 (30.)
 Trefferlage 0.87 mm rechts, 0.11 mm tief
 Streuwert 2.11, horizontal: 2.40, vertikal: 1.78

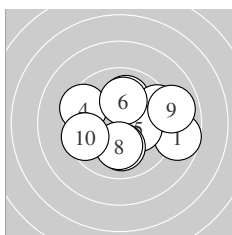
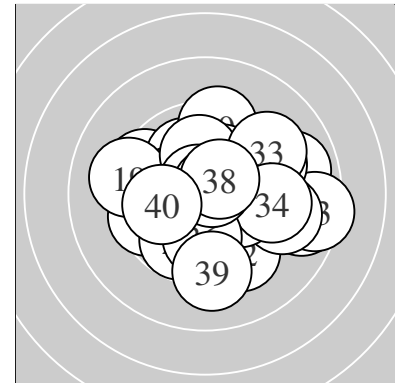

Serie 1:
 8.7 → 10.0 ↑ 9.4 → 9.5 ↖ 10.2 *
 10.1 ↑ 10.1 ↓ 10.1 ↓ 8.9 → 9.6 ←
 beste Teiler 183.6 (5.) 212.8 (6.) 213.1 (8.)
 Trefferlage 1.00 mm rechts, 0.11 mm hoch
 Streuwert 2.48, horizontal: 3.03, vertikal: 1.77

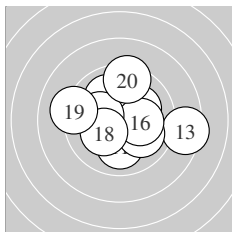

Serie 2:
 10.0 ↓ 10.0 ↖ 8.4 → 10.0 ↘ 10.1 ↗
 10.2 * 10.2 * 10.2 * 9.2 ← 9.4 ↑
 beste Teiler 185.6 (18.) 189.1 (17.) 193.7 (16.)
 Trefferlage 0.38 mm rechts, 0.24 mm hoch
 Streuwert 2.41, horizontal: 2.87, vertikal: 1.83

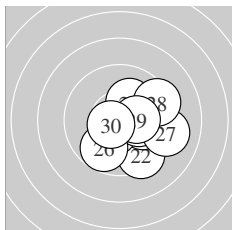

Serie 3:
 10.2 * 9.4 ↘ 10.1 → 10.5 * 10.2 *
 9.8 ↙ 9.1 → 9.4 → 10.3 * 10.6 *
 beste Teiler 92.1 (30.) 120.7 (24.) 160.0 (29.)
 Trefferlage 1.36 mm rechts, 0.59 mm tief
 Streuwert 1.74, horizontal: 1.88, vertikal: 1.59

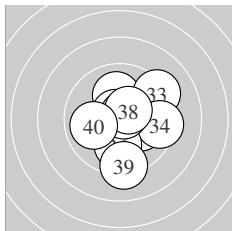

Serie 4:
 10.1 ↑ 10.1 → 9.3 ↗ 9.4 → 10.7 *
 10.0 ↓ 10.7 * 10.5 * 9.2 ↓ 9.9 ←
 beste Teiler 53.7 (37.) 68.0 (35.) 118.0 (38.)
 Trefferlage 0.75 mm rechts, 0.23 mm tief
 Streuwert 1.97, horizontal: 1.89, vertikal: 2.05

Unterschrift des Schützen

Meyton Elektronik

Ergebnis: **397.6** (382)
 Serien: 100.1 99.5 99.3 98.7
 Zähler: 23 16 1 0 0 0 0 0 0 0
 Innenzehner: 16
 weiteste: 695 (11), 494 (3), 447 (31)
 beste Teiler 55.4 (26.) 92.4 (15.) 94.3 (8.)
 Trefferlage 0.22 mm rechts, 1.19 mm hoch
 Streuwert 1.83, horizontal: 2.28, vertikal: 1.21

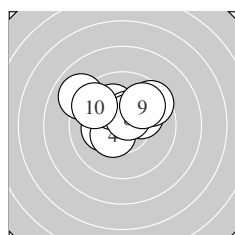
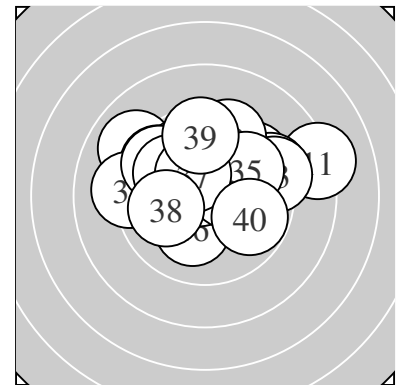

Serie 1:
 10.2 * 10.2 * 9.0 ↘ 10.4 * 9.6 ↗
 10.1 ↘ 10.5 * 10.6 * 9.9 ↗ 9.6 ↘
 beste Teiler 94.3 (8.) 119.6 (7.) 131.5 (4.)
 Trefferlage 0.30 mm links, 1.20 mm hoch
 Streuwert 1.76, horizontal: 2.20, vertikal: 1.15

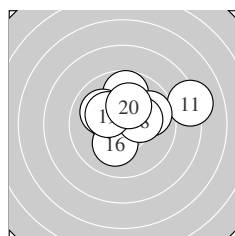

Serie 2:
 8.2 → 9.7 ↑ 10.0 ↘ 10.4 * 10.6 *
 10.1 ↓ 9.8 → 10.2 * 10.3 * 10.2 *
 beste Teiler 92.4 (15.) 140.9 (14.) 171.9 (19.)
 Trefferlage 0.81 mm rechts, 0.93 mm hoch
 Streuwert 2.00, horizontal: 2.51, vertikal: 1.30

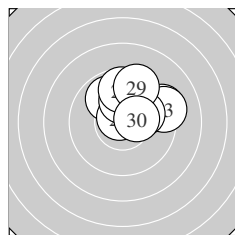

Serie 3:
 10.3 * 9.3 → 9.3 → 9.9 ↘ 10.1 →
 10.7 * 10.1 ↑ 9.7 ↑ 9.5 ↑ 10.4 *
 beste Teiler 55.4 (26.) 141.6 (30.) 169.0 (21.)
 Trefferlage 1.21 mm rechts, 1.60 mm hoch
 Streuwert 1.48, horizontal: 1.78, vertikal: 1.11

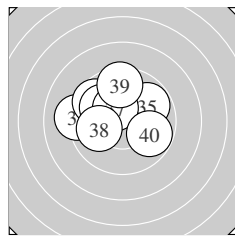

Serie 4:
 9.2 ← 10.2 * 10.2 * 9.6 ↘ 9.8 ↗
 10.0 ↘ 10.4 * 10.0 ← 9.5 ↑ 9.8 ↘
 beste Teiler 146.3 (37.) 181.6 (33.) 200.5 (32.)
 Trefferlage 0.82 mm links, 1.01 mm hoch
 Streuwert 1.89, horizontal: 2.30, vertikal: 1.36

Unterschrift des Schützen

Meyton Elektronik

Ergebnis: **391.9** (375)
 Serien: 97.0 99.8 100.7 94.4
 Zähler: 19 17 4 0 0 0 0 0 0 0
 Innenzehner: 15
 weiteste: 673 (1), 658 (34), 532 (27)
 beste Teiler 30.2 (23.) 84.0 (14.) 87.2 (30.)
 Trefferlage 0.48 mm rechts, 0.35 mm hoch
 Streuwert 2.31, horizontal: 2.79, vertikal: 1.71

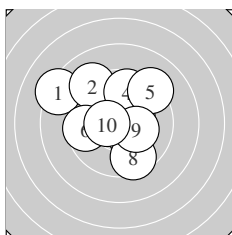
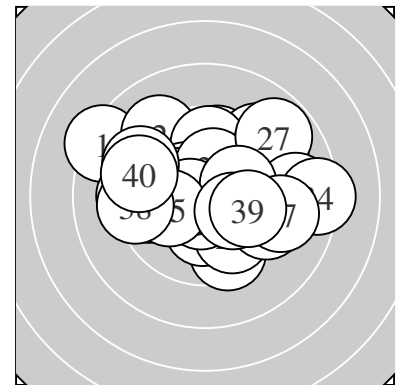

Serie 1:
 8.3 ↘ 9.1 ↘ 10.4 * 9.7 ↑ 9.2 ↗
 9.6 ← 10.4 * 9.5 ↓ 10.3 * 10.5 *
 beste Teiler 124.0 (10.) 133.6 (7.) 135.0 (3.)
 Trefferlage 0.44 mm links, 0.81 mm hoch
 Streuwert 2.56, horizontal: 2.79, vertikal: 2.32

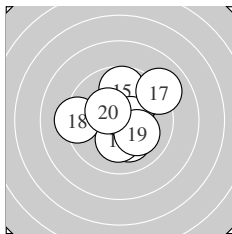

Serie 2:
 10.1 ↓ 10.2 * 9.9 ↗ 10.6 * 9.7 ↑
 10.5 * 9.0 ↗ 9.3 ← 10.1 ↓ 10.4 *
 beste Teiler 84.0 (14.) 109.1 (16.) 145.2 (20.)
 Trefferlage 0.40 mm rechts, 0.47 mm hoch
 Streuwert 1.94, horizontal: 2.09, vertikal: 1.79

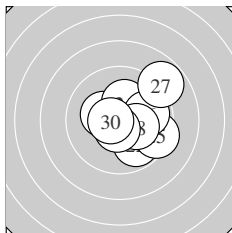

Serie 3:
 10.3 * 9.8 ↓ 10.8 * 10.2 * 9.4 ↘
 9.9 → 8.8 ↗ 10.3 * 10.6 * 10.6 *
 beste Teiler 30.2 (23.) 87.2 (30.) 92.1 (29.)
 Trefferlage 1.09 mm rechts, 0.11 mm hoch
 Streuwert 1.78, horizontal: 1.91, vertikal: 1.64

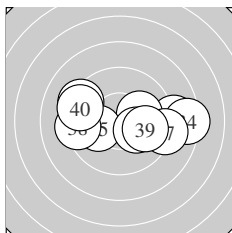

Serie 4:
 8.8 → 10.1 → 9.3 ↘ 8.3 → 10.1 ←
 10.2 * 9.1 → 9.3 ← 9.9 → 9.3 ↖
 beste Teiler 185.2 (36.) 205.9 (32.) 219.7 (35.)
 Trefferlage 0.85 mm rechts, 0.01 mm hoch
 Streuwert 2.94, horizontal: 4.04, vertikal: 0.99

Unterschrift des Schützen

Meyton Elektronik

Ergebnis: **403.9** (387)
 Serien: 101.3 100.6 101.2 100.8
 Zähler: 28 11 1 0 0 0 0 0 0 0
 Innenzehner: 21
 weiteste: 555 (24), 457 (8), 412 (20)
 beste Teiler 36.0 (25.) 41.8 (26.) 83.2 (16.)
 Trefferlage 0.03 mm rechts, 0.05 mm hoch
 Streuwert 1.75, horizontal: 1.68, vertikal: 1.81

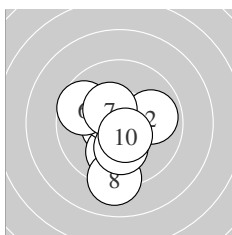
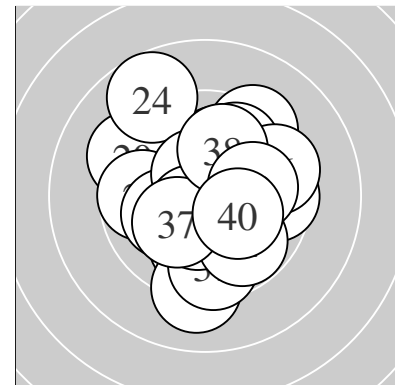

Serie 1:
 10.6 * 9.9 → 10.5 * 10.0 ↓ 10.5 *
 9.7 ↖ 10.4 * 9.1 ↓ 10.1 ↓ 10.5 *
 beste Teiler 98.6 (1.) 109.7 (5.) 110.4 (10.)
 Trefferlage 0.30 mm links, 0.77 mm tief
 Streuwert 1.63, horizontal: 1.39, vertikal: 1.84

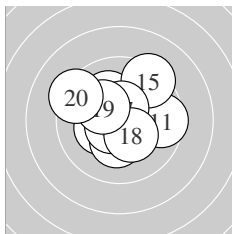

Serie 2:
 9.6 → 10.1 ↖ 10.3 * 10.3 * 9.3 ↗
 10.6 * 10.6 * 10.3 * 10.2 * 9.3 ↖
 beste Teiler 83.2 (16.) 100.4 (17.) 155.4 (18.)
 Trefferlage 0.14 mm links, 0.50 mm hoch
 Streuwert 1.82, horizontal: 2.03, vertikal: 1.59

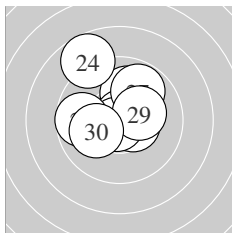

Serie 3:
 10.0 ↑ 10.5 * 10.5 * 8.7 ↖ 10.8 *
 10.8 * 9.8 ↗ 9.7 ← 10.3 * 10.1 ←
 beste Teiler 36.0 (25.) 41.8 (26.) 117.3 (23.)
 Trefferlage 0.19 mm links, 0.96 mm hoch
 Streuwert 1.75, horizontal: 1.74, vertikal: 1.75

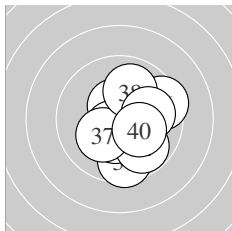

Serie 4:
 9.6 ↓ 10.4 * 10.5 * 9.8 ↘ 10.6 *
 9.5 → 10.2 * 10.0 ↑ 10.0 → 10.2 *
 beste Teiler 93.6 (35.) 117.1 (33.) 147.4 (32.)
 Trefferlage 0.78 mm rechts, 0.48 mm tief
 Streuwert 1.65, horizontal: 1.53, vertikal: 1.76

Unterschrift des Schützen

Meyton Elektronik

Ergebnis: **395.8** (383)
 Serien: 98.7 98.6 98.6 99.9
 Zähler: 24 15 1 0 0 0 0 0 0 0
 Innenzehner: 15
 weiteste: 697 (18), 483 (21), 443 (12)
 beste Teiler 32.2 (10.) 44.1 (36.) 50.2 (14.)
 Trefferlage 0.44 mm rechts, 0.10 mm tief
 Streuwert 2.12, horizontal: 2.17, vertikal: 2.08

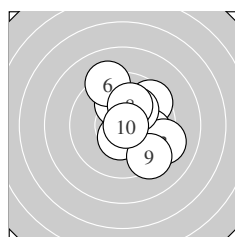
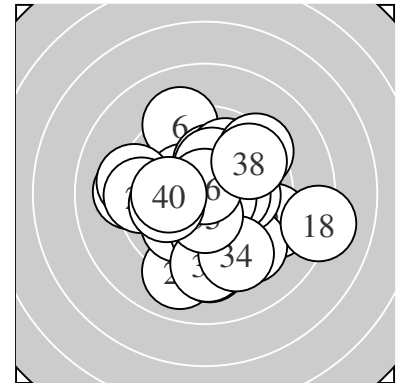

Serie 1:
 9.5 ↗ 9.9 → 9.2 ↘ 10.5 * 10.1 ↑
 9.2 ↖ 10.1 ↗ 10.1 ↑ 9.3 ↘ 10.8 *
 beste Teiler 32.2 (10.) 122.5 (4.) 202.6 (7.)
 Trefferlage 1.22 mm rechts, 0.53 mm hoch
 Streuwert 1.99, horizontal: 1.76, vertikal: 2.20

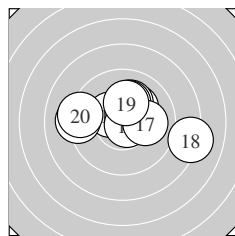

Serie 2:
 10.4 * 9.2 ← 10.2 * 10.8 * 10.1 ↑
 10.2 * 10.1 → 8.2 → 10.2 * 9.2 ←
 beste Teiler 50.2 (14.) 146.1 (11.) 193.0 (19.)
 Trefferlage 0.25 mm rechts, 0.67 mm hoch
 Streuwert 2.41, horizontal: 3.20, vertikal: 1.20

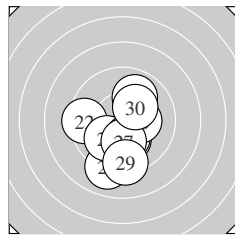

Serie 3:
 9.0 ↓ 9.4 ← 10.2 * 10.0 ✓ 10.2 *
 10.3 * 10.1 ↓ 9.9 ↑ 9.3 ↓ 10.2 *
 beste Teiler 165.1 (26.) 179.6 (30.) 180.7 (25.)
 Trefferlage 0.12 mm links, 1.29 mm tief
 Streuwert 1.95, horizontal: 1.68, vertikal: 2.19

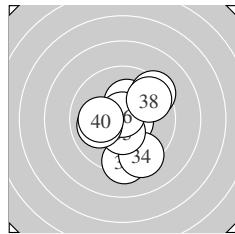

Serie 4:
 10.3 * 10.6 * 9.3 ↓ 9.4 ↘ 10.4 *
 10.8 * 9.4 ↗ 9.6 ↗ 10.0 ← 10.1 ←
 beste Teiler 44.1 (36.) 86.0 (32.) 127.0 (35.)
 Trefferlage 0.44 mm rechts, 0.33 mm tief
 Streuwert 2.01, horizontal: 1.77, vertikal: 2.22

Unterschrift des Schützen

Ergebnis: **387.9** (367)
 Serien: 97.9 99.7 94.6 95.7
 Zähler: 16 17 5 2 0 0 0 0 0 0
 Innenzehner: 13
 weiteste: 780 (26), 767 (37), 660 (23)
 beste Teiler 17.2 (40.) 90.3 (38.) 96.5 (20.)
 Trefferlage 0.72 mm links, 0.25 mm tief
 Streuwert 2.55, horizontal: 2.51, vertikal: 2.59

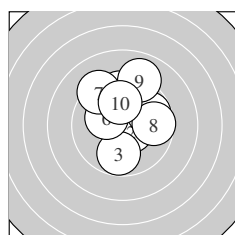
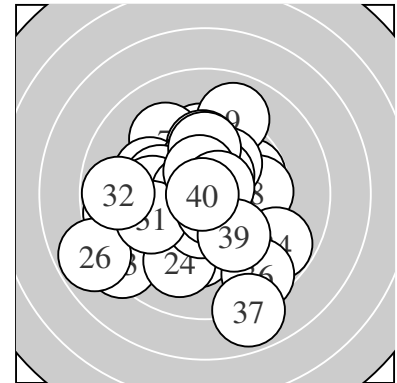

Serie 1:
 9.6 ↑ 10.5 * 9.8 ↓ 10.0 ↖ 9.8 ↗
 10.2 * 9.3 ↘ 9.7 → 9.0 ↑ 10.0 ↑
 beste Teiler 107.0 (2.) 182.5 (6.) 233.0 (4.)
 Trefferlage 0.23 mm rechts, 1.44 mm hoch
 Streuwert 2.04, horizontal: 1.87, vertikal: 2.21

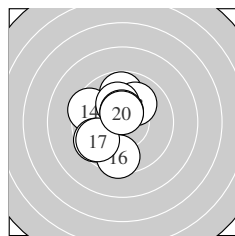

Serie 2:
 10.3 * 9.8 ↑ 10.0 ↗ 9.5 ↖ 9.6 ↙
 9.5 ↓ 9.7 ↙ 10.2 * 10.5 * 10.6 *
 beste Teiler 96.5 (20.) 107.4 (19.) 164.0 (11.)
 Trefferlage 1.01 mm links, 0.37 mm hoch
 Streuwert 1.79, horizontal: 1.48, vertikal: 2.06

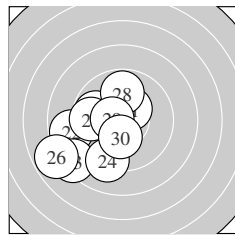

Serie 3:
 10.4 * 8.8 ← 8.3 ↙ 9.2 ↓ 9.8 ↖
 7.8 ↙ 9.7 ← 9.8 ↑ 10.5 * 10.3 *
 beste Teiler 108.9 (29.) 140.9 (21.) 174.5 (30.)
 Trefferlage 2.53 mm links, 1.00 mm tief
 Streuwert 2.50, horizontal: 2.56, vertikal: 2.43

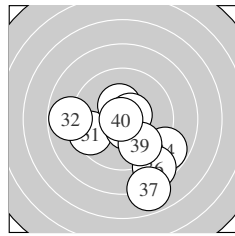

Serie 4:
 9.5 ↙ 8.8 ← 10.4 * 8.8 ↘ 10.5 *
 8.6 ↘ 7.9 ↓ 10.6 * 9.7 ↘ 10.9 *
 beste Teiler 17.2 (40.) 90.3 (38.) 102.8 (35.)
 Trefferlage 0.41 mm rechts, 1.83 mm tief
 Streuwert 2.82, horizontal: 2.97, vertikal: 2.66

Unterschrift des Schützen

Meyton Elektronik

Ergebnis: **414.3** (398)
 Serien: 104.4 103.0 104.5 102.4
 Zähler: 38 2 0 0 0 0 0 0 0 0
 Innenzehner: 28
 weiteste: 277 (4), 253 (18), 249 (12)
 beste Teiler 22.4 (15.) 27.2 (19.) 33.2 (32.)
 Trefferlage 0.09 mm links, 0.03 mm tief
 Streuwert 1.18, horizontal: 1.24, vertikal: 1.11

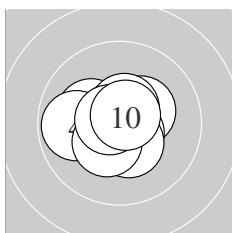
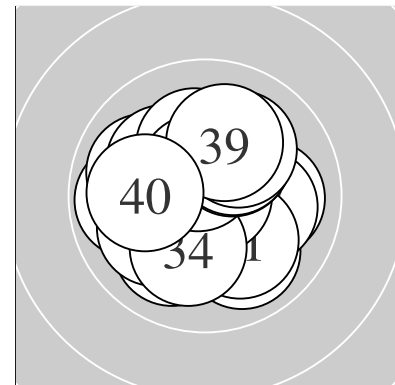

Serie 1:
 10.3 * 10.2 * 10.6 * 9.8 ← 10.4 *
 10.7 * 10.4 * 10.6 * 10.7 * 10.7 *
 beste Teiler 51.6 (6.) 63.0 (10.) 66.7 (9.)
 Trefferlage 0.31 mm links, 0.02 mm hoch
 Streuwert 1.04, horizontal: 1.24, vertikal: 0.80

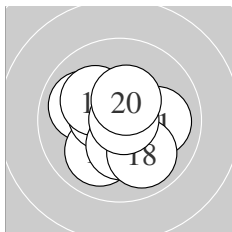

Serie 2:
 10.0 → 10.0 ↖ 10.0 ↙ 10.5 * 10.9 *
 10.2 * 10.3 * 9.9 ↘ 10.8 * 10.4 *
 beste Teiler 22.4 (15.) 27.2 (19.) 109.7 (14.)
 Trefferlage 0.15 mm links, 0.21 mm tief
 Streuwert 1.35, horizontal: 1.42, vertikal: 1.27

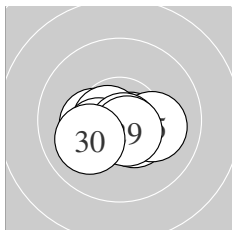

Serie 3:
 10.3 * 10.5 * 10.6 * 10.8 * 10.1 →
 10.6 * 10.3 * 10.7 * 10.6 * 10.0 ↙
 beste Teiler 43.0 (24.) 55.9 (28.) 77.0 (26.)
 Trefferlage 0.11 mm links, 0.55 mm tief
 Streuwert 0.93, horizontal: 1.27, vertikal: 0.34

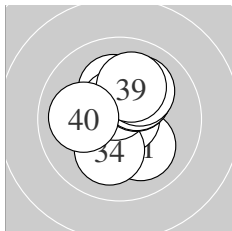

Serie 4:
 10.1 ↘ 10.8 * 10.2 * 10.1 ↓ 10.6 *
 10.2 * 10.2 * 10.1 ↗ 10.1 ↑ 10.0 ←
 beste Teiler 33.2 (32.) 93.3 (35.) 179.8 (36.)
 Trefferlage 0.22 mm rechts, 0.60 mm hoch
 Streuwert 1.32, horizontal: 1.15, vertikal: 1.47

Unterschrift des Schützen

Meyton Elektronik

Ergebnis: **413.1** (391)
 Serien: 103.1 102.4 103.5 104.1
 Zähler: 31 9 0 0 0 0 0 0 0 0
 Innenzehner: 26
 weiteste: 422 (12), 419 (1), 347 (17)
 beste Teiler 10.0 (9.) 39.4 (20.) 45.4 (39.)
 Trefferlage 0.19 mm rechts, 0.00 mm
 Streuwert 1.37, horizontal: 1.68, vertikal: 0.97

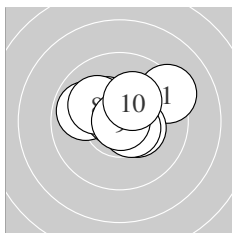
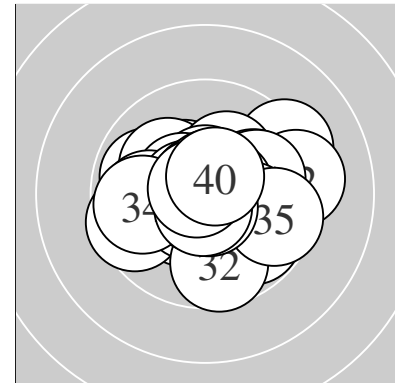

Serie 1:
 9.3 ↗ 9.9 ↖ 10.4 * 10.7 * 10.4 *
 10.7 * 10.5 * 10.1 ↘ 10.9 * 10.2 *
 beste Teiler 10.0 (9.) 52.3 (6.) 54.5 (4.)
 Trefferlage 0.18 mm rechts, 0.61 mm hoch
 Streuwert 1.39, horizontal: 1.74, vertikal: 0.89

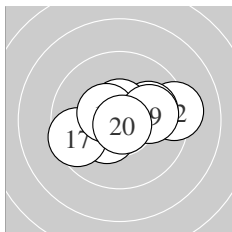

Serie 2:
 10.5 * 9.3 → 10.0 → 10.7 * 10.4 *
 10.6 * 9.6 ← 10.5 * 10.0 → 10.8 *
 beste Teiler 39.4 (20.) 73.9 (14.) 90.0 (16.)
 Trefferlage 0.25 mm rechts, 0.18 mm hoch
 Streuwert 1.59, horizontal: 2.11, vertikal: 0.80

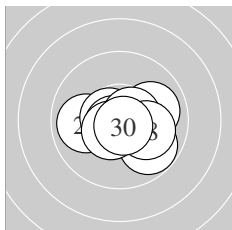

Serie 3:
 9.9 ← 10.6 * 10.6 * 9.8 ↘ 10.0 →
 10.7 * 10.6 * 10.1 → 10.5 * 10.7 *
 beste Teiler 51.3 (30.) 56.7 (26.) 81.7 (22.)
 Trefferlage 0.27 mm rechts, 0.40 mm tief
 Streuwert 1.23, horizontal: 1.59, vertikal: 0.72

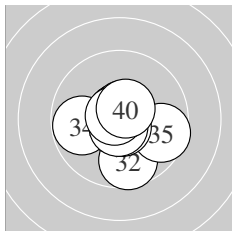

Serie 4:
 10.8 * 9.7 ↓ 10.7 * 9.8 ← 9.6 →
 10.7 * 10.7 * 10.7 * 10.8 * 10.6 *
 beste Teiler 45.4 (39.) 47.9 (31.) 57.3 (33.)
 Trefferlage 0.07 mm rechts, 0.41 mm tief
 Streuwert 1.32, horizontal: 1.46, vertikal: 1.15

Unterschrift des Schützen

Meyton Elektronik

Ergebnis: **396.0** (378)
 Serien: 99.4 98.7 99.1 98.8
 Zähler: 20 18 2 0 0 0 0 0 0 0
 Innenzehner: 16
 weiteste: 507 (24), 504 (19), 499 (7)
 beste Teiler 43.7 (28.) 80.8 (30.) 92.3 (38.)
 Trefferlage 0.17 mm rechts, 0.59 mm hoch
 Streuwert 2.08, horizontal: 2.37, vertikal: 1.73

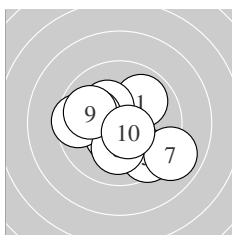
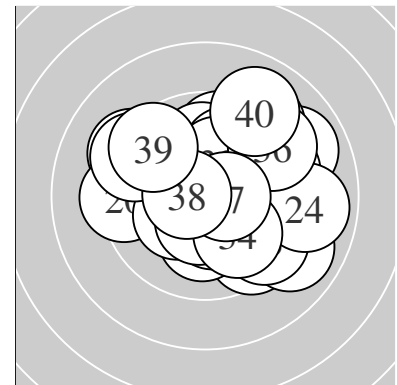

Serie 1:
 9.9 ↗ 10.3 * 10.1 ↖ 10.5 * 9.5 ↘
 9.6 ← 9.0 ↘ 10.1 ↓ 9.9 ↖ 10.5 *
 beste Teiler 102.5 (10.) 125.7 (4.) 171.4 (2.)
 Trefferlage 0.07 mm links, 0.42 mm tief
 Streuwert 2.06, horizontal: 2.40, vertikal: 1.66

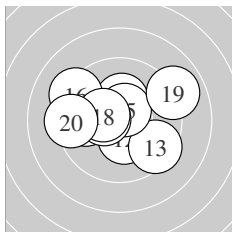

Serie 2:
 9.8 ← 10.3 * 9.5 ↘ 10.3 * 10.6 *
 9.2 ↖ 10.4 * 10.4 * 8.9 ↗ 9.3 ←
 beste Teiler 94.8 (15.) 130.3 (17.) 144.2 (18.)
 Trefferlage 0.48 mm links, 0.37 mm hoch
 Streuwert 2.22, horizontal: 2.77, vertikal: 1.47

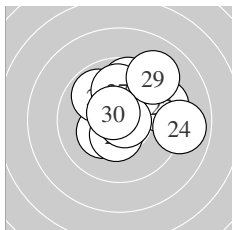

Serie 3:
 10.3 * 9.4 ↗ 10.4 * 8.9 → 9.7 ↑
 9.9 ↘ 10.0 ↑ 10.8 * 9.1 ↗ 10.6 *
 beste Teiler 43.7 (28.) 80.8 (30.) 126.3 (23.)
 Trefferlage 0.83 mm rechts, 1.01 mm hoch
 Streuwert 2.00, horizontal: 2.24, vertikal: 1.73

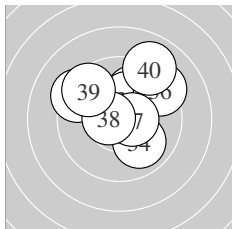

Serie 4:
 10.5 * 9.9 ↗ 10.2 * 10.0 ↘ 9.3 ↖
 9.3 ↗ 10.5 * 10.6 * 9.5 ↖ 9.0 ↗
 beste Teiler 92.3 (38.) 106.0 (37.) 119.8 (31.)
 Trefferlage 0.40 mm rechts, 1.43 mm hoch
 Streuwert 1.96, horizontal: 2.18, vertikal: 1.72

Unterschrift des Schützen

Ergebnis: **400.3** (381)
 Serien: 100.6 100.7 97.9 101.1
 Zähler: 23 15 2 0 0 0 0 0 0 0
 Innenzehner: 16
 weiteste: 582 (26), 517 (14), 492 (21)
 beste Teiler 37.3 (10.) 53.2 (13.) 58.1 (15.)
 Trefferlage 0.00 mm , 0.21 mm hoch
 Streuwert 1.93, horizontal: 1.93, vertikal: 1.93

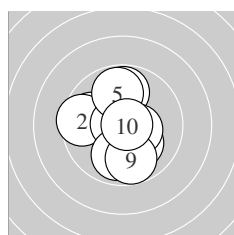
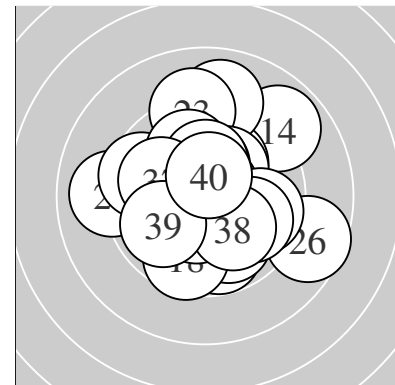

Serie 1:
 9.8 ← 9.5 ← 9.8 ↑ 10.7 * 9.8 ↑
 10.1 ↘ 9.9 ↓ 10.4 * 9.8 ↓ 10.8 *
 beste Teiler 37.3 (10.) 58.2 (4.) 131.2 (8.)
 Trefferlage 0.39 mm links, 0.05 mm tief
 Streuwert 1.77, horizontal: 1.59, vertikal: 1.94

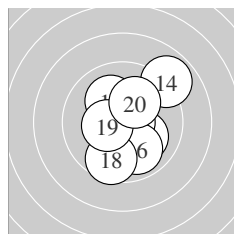

Serie 2:
 10.1 ↘ 10.2 * 10.7 * 8.9 ↗ 10.7 *
 9.9 ↓ 10.1 ↖ 9.6 ↓ 10.4 * 10.1 ↗
 beste Teiler 53.2 (13.) 58.1 (15.) 136.3 (19.)
 Trefferlage 0.55 mm rechts, 0.20 mm tief
 Streuwert 1.84, horizontal: 1.55, vertikal: 2.09

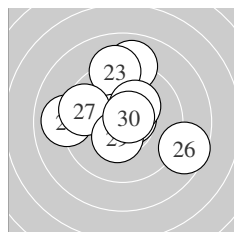

Serie 3:
 9.0 ↑ 9.0 ← 9.2 ↑ 10.6 * 10.6 *
 8.6 ↘ 9.6 ← 10.2 * 10.4 * 10.7 *
 beste Teiler 68.8 (30.) 76.1 (24.) 89.4 (25.)
 Trefferlage 0.17 mm links, 0.92 mm hoch
 Streuwert 2.49, horizontal: 2.73, vertikal: 2.23

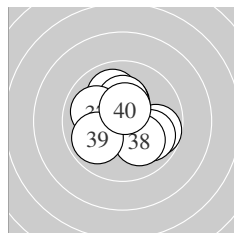

Serie 4:
 10.0 ↖ 9.8 → 10.3 * 9.9 ↘ 10.3 *
 10.3 * 10.0 ← 10.1 ↘ 9.9 ↙ 10.5 *
 beste Teiler 109.8 (40.) 158.3 (33.) 162.9 (36.)
 Trefferlage 0.01 mm rechts, 0.17 mm hoch
 Streuwert 1.64, horizontal: 1.80, vertikal: 1.47

Unterschrift des Schützen

Meyton Elektronik

Ergebnis: **415.8** (398)
 Serien: 104.1 105.4 103.4 102.9
 Zähler: 38 2 0 0 0 0 0 0 0 0
 Innenzehner: 30
 weiteste: 387 (28), 291 (35), 245 (14)
 beste Teiler 8.6 (15.) 26.0 (3.) 29.5 (10.)
 Trefferlage 0.16 mm links, 0.24 mm hoch
 Streuwert 1.13, horizontal: 1.24, vertikal: 1.02

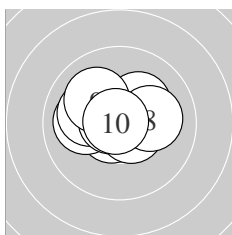
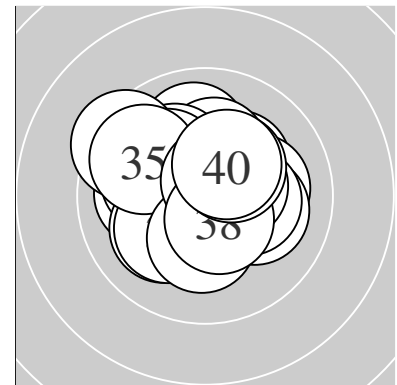

Serie 1:
 10.7 * 10.0 ← 10.8 * 10.1 ↖ 10.2 *
 10.7 * 10.6 * 10.1 → 10.1 ↗ 10.8 *
 beste Teiler 26.0 (3.) 29.5 (10.) 59.6 (6.)
 Trefferlage 0.29 mm links, 0.33 mm hoch
 Streuwert 1.12, horizontal: 1.43, vertikal: 0.67

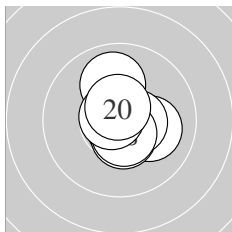

Serie 2:
 10.7 * 10.1 → 10.8 * 10.0 ↑ 10.9 *
 10.5 * 10.5 * 10.6 * 10.7 * 10.6 *
 beste Teiler 8.6 (15.) 47.0 (13.) 58.6 (19.)
 Trefferlage 0.32 mm rechts, 0.01 mm hoch
 Streuwert 0.90, horizontal: 0.77, vertikal: 1.01

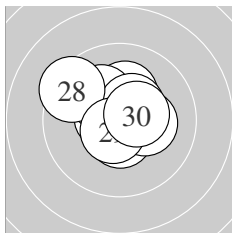

Serie 3:
 10.6 * 10.6 * 10.2 * 10.5 * 10.2 *
 10.3 * 10.5 * 9.4 ↖ 10.6 * 10.5 *
 beste Teiler 84.9 (29.) 86.0 (21.) 89.2 (22.)
 Trefferlage 0.16 mm links, 0.58 mm hoch
 Streuwert 1.25, horizontal: 1.41, vertikal: 1.05

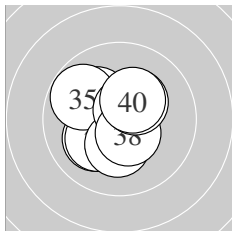

Serie 4:
 10.1 ↙ 10.6 * 10.1 ↖ 10.2 * 9.8 ↖
 10.3 * 10.7 * 10.5 * 10.3 * 10.3 *
 beste Teiler 75.4 (37.) 98.9 (32.) 112.1 (38.)
 Trefferlage 0.53 mm links, 0.03 mm hoch
 Streuwert 1.27, horizontal: 1.26, vertikal: 1.29

Unterschrift des Schützen

Ergebnis: **393.7** (379)
 Serien: 97.2 99.1 98.6 98.8
 Zähler: 21 17 2 0 0 0 0 0 0 0
 Innenzehner: 11
 weiteste: 596 (27), 510 (20), 494 (11)
 beste Teiler 16.0 (12.) 82.6 (36.) 94.6 (25.)
 Trefferlage 0.58 mm links, 0.09 mm tief
 Streuwert 2.15, horizontal: 2.20, vertikal: 2.11

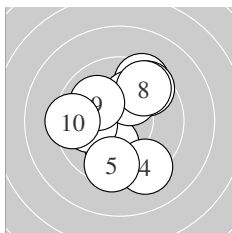
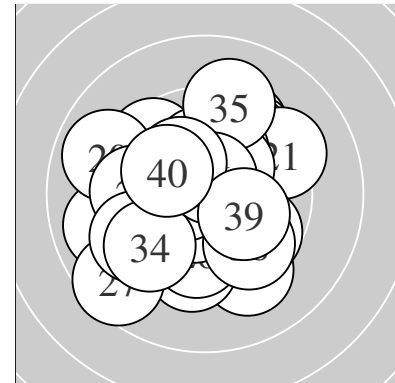

Serie 1:
 10.2 * 9.5 ↗ 10.0 ← 9.3 ↘ 9.5 ↓
 9.6 ↗ 10.1 ↑ 9.6 ↗ 10.0 ↖ 9.4 ←
 beste Teiler 199.2 (1.) 205.5 (7.) 236.1 (9.)
 Trefferlage 0.04 mm links, 0.25 mm hoch
 Streuwert 2.38, horizontal: 2.16, vertikal: 2.58

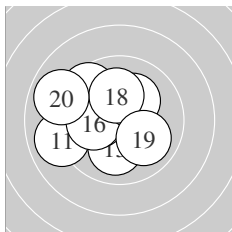

Serie 2:
 9.0 ← 10.9 * 10.0 ↓ 10.3 * 9.6 ↘
 10.1 ← 10.2 * 10.1 ↑ 10.0 ↘ 8.9 ↖
 beste Teiler 16.0 (12.) 173.0 (14.) 191.3 (17.)
 Trefferlage 1.33 mm links, 0.23 mm hoch
 Streuwert 1.98, horizontal: 2.25, vertikal: 1.67

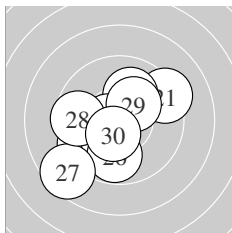

Serie 3:
 9.3 ↗ 10.1 ↑ 9.6 ← 10.2 * 10.6 *
 9.8 ↓ 8.6 ↖ 9.6 ← 10.3 * 10.5 *
 beste Teiler 94.6 (25.) 123.9 (30.) 172.8 (29.)
 Trefferlage 0.75 mm links, 0.65 mm tief
 Streuwert 2.23, horizontal: 2.35, vertikal: 2.09

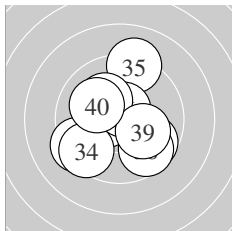

Serie 4:
 9.3 ← 10.5 * 9.7 ↘ 9.5 ↖ 9.1 ↑
 10.6 * 10.2 * 9.7 ↘ 10.1 ↘ 10.1 ↖
 beste Teiler 82.6 (36.) 105.1 (32.) 193.0 (37.)
 Trefferlage 0.21 mm links, 0.22 mm tief
 Streuwert 2.17, horizontal: 2.12, vertikal: 2.21

Unterschrift des Schützen

Ergebnis: **414.8** (399)
 Serien: 103.1 103.5 103.7 104.5
 Zähler: 39 1 0 0 0 0 0 0 0 0
 Innenzehner: 32
 weiteste: 253 (2), 243 (20), 238 (9)
 beste Teiler 48.0 (7.) 60.0 (33.) 73.0 (22.)
 Trefferlage 0.13 mm links, 0.35 mm hoch
 Streuwert 1.09, horizontal: 1.12, vertikal: 1.07

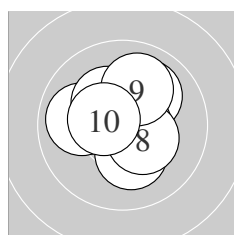
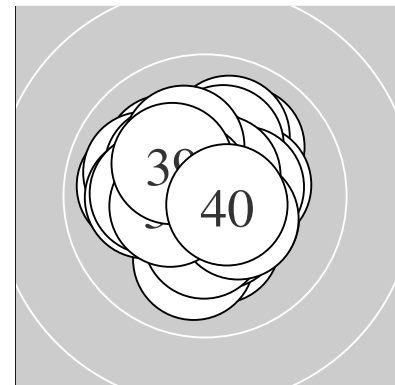

Serie 1:
 10.2 * 9.9 ← 10.0 ↗ 10.6 * 10.4 *
 10.3 * 10.8 * 10.4 * 10.0 ↑ 10.5 *
 beste Teiler 48.0 (7.) 81.2 (4.) 121.7 (10.)
 Trefferlage 0.02 mm links, 0.54 mm hoch
 Streuwert 1.23, horizontal: 1.25, vertikal: 1.22

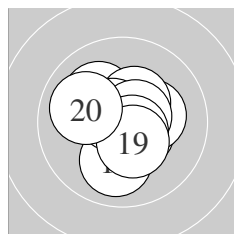

Serie 2:
 10.1 ↘ 10.5 * 10.3 * 10.4 * 10.0 ↓
 10.6 * 10.6 * 10.6 * 10.4 * 10.0 ←
 beste Teiler 77.2 (16.) 82.0 (18.) 87.2 (17.)
 Trefferlage 0.05 mm rechts, 0.00 mm
 Streuwert 1.20, horizontal: 1.22, vertikal: 1.18

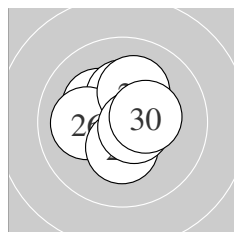

Serie 3:
 10.2 * 10.7 * 10.6 * 10.3 * 10.3 *
 10.1 ← 10.3 * 10.2 * 10.6 * 10.4 *
 beste Teiler 73.0 (22.) 77.4 (29.) 86.2 (23.)
 Trefferlage 0.14 mm links, 0.46 mm hoch
 Streuwert 1.08, horizontal: 1.07, vertikal: 1.09

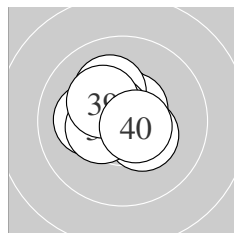

Serie 4:
 10.4 * 10.5 * 10.7 * 10.1 ← 10.6 *
 10.2 * 10.7 * 10.4 * 10.3 * 10.6 *
 beste Teiler 60.0 (33.) 75.2 (37.) 87.4 (40.)
 Trefferlage 0.41 mm links, 0.39 mm hoch
 Streuwert 0.94, horizontal: 1.02, vertikal: 0.85

Unterschrift des Schützen

Meyton Elektronik