

Ergebnis: **411.7** (391)
 Serien: 104.4 103.2 103.0 101.1
 Zähler: 32 7 1 0 0 0 0 0 0 0
 Innenzehner: 29
 weiteste: 548 (40), 345 (37), 301 (13)
 beste Teiler 5.3 (8.) 44.7 (22.) 57.2 (16.)
 Trefferlage 0.21 mm links, 0.69 mm tief
 Streuwert 1.27, horizontal: 1.46, vertikal: 1.04

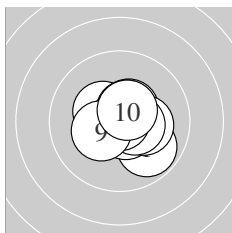

Serie 1:
 9.8 ↘ 10.5 * 10.6 * 10.4 * 10.6 *
 10.2 * 10.5 * 10.9 * 10.3 * 10.6 *
 beste Teiler 5.3 (8.) 77.2 (3.) 96.8 (5.)
 Trefferlage 0.45 mm rechts, 0.04 mm tief
 Streuwert 1.02, horizontal: 1.12, vertikal: 0.90

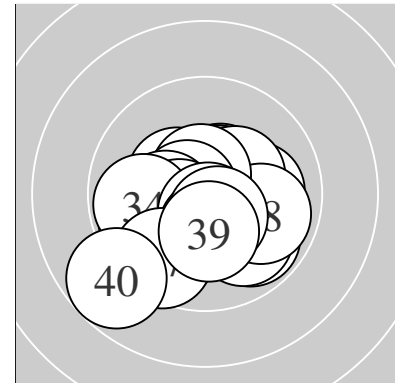
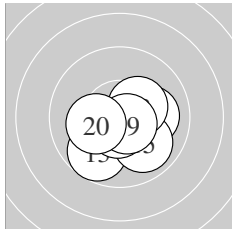

Serie 2:
 10.1 → 10.4 * 9.7 ↙ 10.6 * 9.9 ↘
 10.7 * 10.6 * 10.3 * 10.7 * 10.2 *
 beste Teiler 57.2 (16.) 74.3 (19.) 83.0 (17.)
 Trefferlage 0.29 mm rechts, 0.69 mm tief
 Streuwert 1.17, horizontal: 1.35, vertikal: 0.96

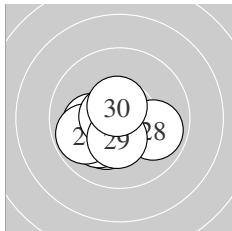

Serie 3:
 10.2 * 10.8 * 10.1 ↙ 10.1 ← 10.6 *
 9.8 ↙ 10.6 * 9.9 → 10.3 * 10.6 *
 beste Teiler 44.7 (22.) 80.8 (27.) 90.0 (30.)
 Trefferlage 0.48 mm links, 0.71 mm tief
 Streuwert 1.17, horizontal: 1.45, vertikal: 0.79

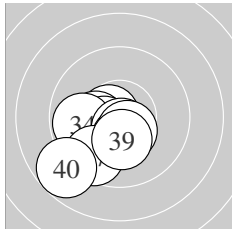

Serie 4:
 10.6 * 10.2 * 10.4 * 9.8 ← 10.6 *
 10.3 * 9.6 ↙ 10.5 * 10.3 * 8.8 ↙
 beste Teiler 81.5 (31.) 85.0 (35.) 115.4 (38.)
 Trefferlage 1.13 mm links, 1.30 mm tief
 Streuwert 1.35, horizontal: 1.48, vertikal: 1.22

Unterschrift des Schützen

Ergebnis: **406.3** (389)
 Serien: 103.8 100.3 100.3 101.9
 Zähler: 31 7 2 0 0 0 0 0 0 0
 Innenzehner: 24
 weiteste: 558 (21), 529 (27), 490 (14)
 beste Teiler 52.4 (20.) 53.0 (7.) 58.2 (4.)
 Trefferlage 0.14 mm rechts, 0.14 mm tief
 Streuwert 1.67, horizontal: 2.14, vertikal: 0.99

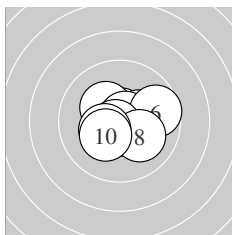
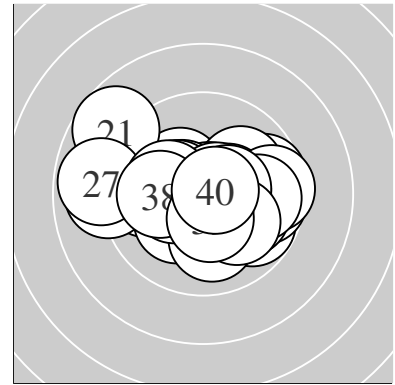

Serie 1:
 10.7 * 10.3 * 10.3 * 10.7 * 10.6 *
 9.7 → 10.7 * 10.1 ↘ 10.4 * 10.3 *
 beste Teiler 53.0 (7.) 58.2 (4.) 62.6 (1.)
 Trefferlage 0.33 mm rechts, 0.09 mm tief
 Streuwert 1.21, horizontal: 1.46, vertikal: 0.88

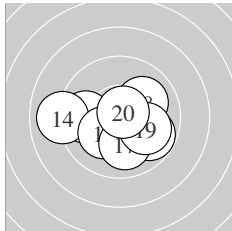

Serie 2:
 10.5 * 9.8 ↘ 9.8 ← 9.0 ← 10.3 *
 10.2 * 10.0 ↓ 10.0 ↗ 10.0 → 10.7 *
 beste Teiler 52.4 (20.) 105.5 (11.) 152.7 (15.)
 Trefferlage 0.01 mm links, 0.61 mm tief
 Streuwert 1.85, horizontal: 2.38, vertikal: 1.07

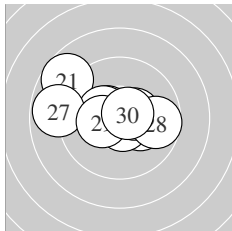

Serie 3:
 8.7 ↘ 10.5 * 10.4 * 10.2 * 10.7 *
 10.4 * 8.8 ← 9.7 → 10.3 * 10.6 *
 beste Teiler 67.6 (25.) 80.2 (30.) 120.7 (22.)
 Trefferlage 0.65 mm links, 0.39 mm hoch
 Streuwert 2.05, horizontal: 2.66, vertikal: 1.14

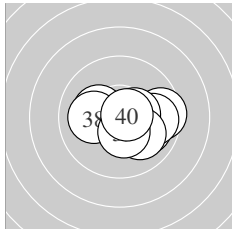

Serie 4:
 10.0 ↘ 9.5 → 10.7 * 9.8 → 10.2 *
 10.4 * 10.1 ↘ 10.1 ← 10.4 * 10.7 *
 beste Teiler 65.8 (40.) 65.9 (33.) 129.8 (36.)
 Trefferlage 0.92 mm rechts, 0.28 mm tief
 Streuwert 1.39, horizontal: 1.85, vertikal: 0.69

Unterschrift des Schützen

Meyton Elektronik

Ergebnis: **409.4** (394)
 Serien: 101.7 102.7 100.0 105.0
 Zähler: 34 6 0 0 0 0 0 0 0 0
 Innenzehner: 25
 weiteste: 468 (2), 350 (29), 307 (12)
 beste Teiler 49.8 (33.) 50.0 (13.) 59.0 (14.)
 Trefferlage 0.17 mm links, 0.00 mm
 Streuwert 1.44, horizontal: 1.81, vertikal: 0.93

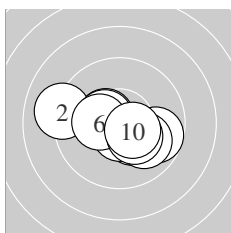
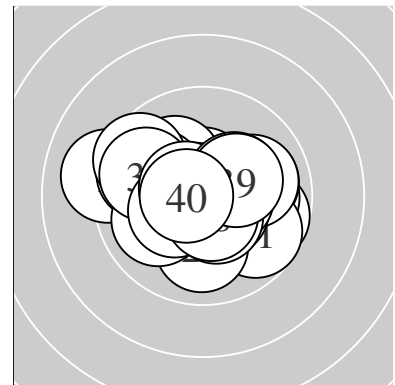

Serie 1:
 10.5 * 9.1 ← 10.3 * 10.6 * 10.4 *
 10.3 * 9.7 → 10.0 ↘ 10.3 * 10.5 *
 beste Teiler 81.0 (4.) 118.5 (10.) 123.4 (1.)
 Trefferlage 0.03 mm links, 0.39 mm tief
 Streuwert 1.63, horizontal: 2.16, vertikal: 0.82

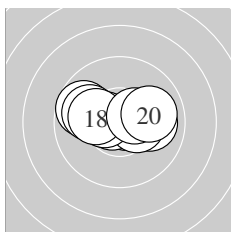

Serie 2:
 10.0 → 9.7 ← 10.8 * 10.7 * 10.4 *
 10.0 ← 10.5 * 10.2 * 10.4 * 10.0 →
 beste Teiler 50.0 (13.) 59.0 (14.) 120.6 (17.)
 Trefferlage 0.11 mm links, 0.33 mm hoch
 Streuwert 1.41, horizontal: 1.95, vertikal: 0.42

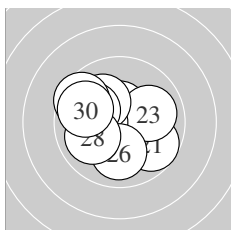

Serie 3:
 9.7 ↘ 10.5 * 10.0 → 10.3 * 10.1 ↖
 10.0 ↓ 10.0 ← 10.0 ← 9.6 ↖ 9.8 ←
 beste Teiler 105.0 (22.) 159.0 (24.) 209.3 (25.)
 Trefferlage 0.82 mm links, 0.18 mm hoch
 Streuwert 1.73, horizontal: 1.99, vertikal: 1.44

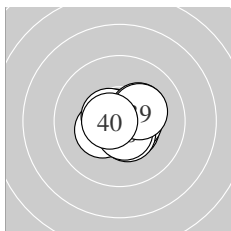

Serie 4:
 10.5 * 10.5 * 10.8 * 10.3 * 10.6 *
 10.3 * 10.5 * 10.6 * 10.3 * 10.6 *
 beste Teiler 49.8 (33.) 80.0 (40.) 91.7 (35.)
 Trefferlage 0.28 mm rechts, 0.11 mm tief
 Streuwert 0.89, horizontal: 1.06, vertikal: 0.68

Unterschrift des Schützen

Meyton Elektronik

Ergebnis: **416.3** (400)
 Serien: 104.6 104.3 104.0 103.4
 Zähler: 40 0 0 0 0 0 0 0 0 0
 Innenzehner: 35
 weiteste: 246 (35), 234 (37), 231 (25)
 beste Teiler 27.7 (33.) 55.0 (24.) 60.5 (5.)
 Trefferlage 0.15 mm links, 0.26 mm tief
 Streuwert 1.01, horizontal: 1.17, vertikal: 0.82

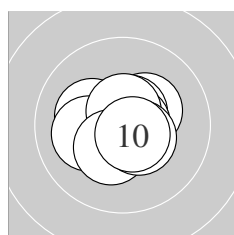
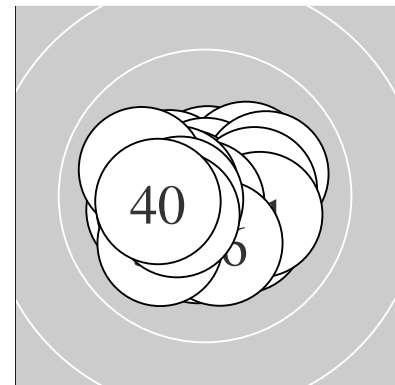

Serie 1:
 10.6 * 10.3 * 10.6 * 10.2 * 10.7 *
 10.1 ← 10.6 * 10.4 * 10.5 * 10.6 *
 beste Teiler 60.5 (5.) 80.6 (10.) 83.2 (7.)
 Trefferlage 0.04 mm links, 0.08 mm tief
 Streuwert 0.98, horizontal: 1.13, vertikal: 0.80

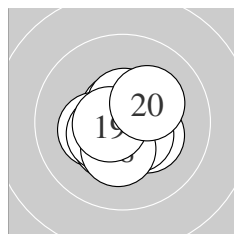

Serie 2:
 10.3 * 10.5 * 10.7 * 10.3 * 10.4 *
 10.6 * 10.4 * 10.3 * 10.6 * 10.2 *
 beste Teiler 68.5 (13.) 77.1 (19.) 97.4 (16.)
 Trefferlage 0.09 mm links, 0.28 mm tief
 Streuwert 0.99, horizontal: 1.06, vertikal: 0.92

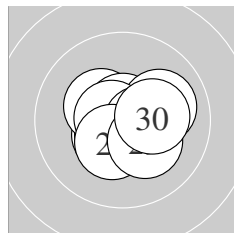

Serie 3:
 10.5 * 10.5 * 10.3 * 10.7 * 10.0 →
 10.7 * 10.5 * 10.4 * 10.2 * 10.2 *
 beste Teiler 55.0 (24.) 67.2 (26.) 108.4 (22.)
 Trefferlage 0.24 mm rechts, 0.20 mm tief
 Streuwert 1.05, horizontal: 1.24, vertikal: 0.83

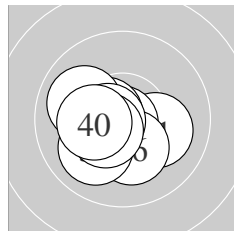

Serie 4:
 10.1 → 10.4 * 10.8 * 10.5 * 10.0 ↖
 10.2 * 10.0 ↙ 10.6 * 10.5 * 10.3 *
 beste Teiler 27.7 (33.) 88.8 (38.) 106.2 (34.)
 Trefferlage 0.71 mm links, 0.49 mm tief
 Streuwert 1.04, horizontal: 1.23, vertikal: 0.82

Unterschrift des Schützen

Meyton Elektronik

Ergebnis: **401.0** (381)
 Serien: 101.6 101.7 100.7 97.0
 Zähler: 23 15 2 0 0 0 0 0 0 0
 Innenzehner: 21
 weiteste: 594 (38), 579 (33), 498 (23)
 beste Teiler 32.5 (13.) 56.0 (14.) 69.3 (25.)
 Trefferlage 0.35 mm links, 0.10 mm tief
 Streuwert 1.93, horizontal: 2.19, vertikal: 1.62

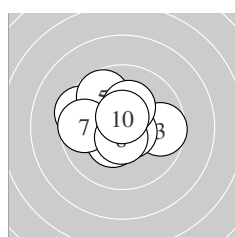
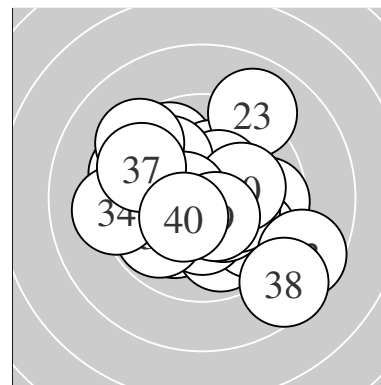

Serie 1:
 9.5 ↖ 10.5 * 9.7 → 10.7 * 9.7 ↗
 10.4 * 9.7 ← 10.6 * 10.2 * 10.6 *
 beste Teiler 75.8 (4.) 86.0 (10.) 87.8 (8.)
 Trefferlage 0.55 mm links, 0.49 mm hoch
 Streuwert 1.61, horizontal: 1.94, vertikal: 1.18

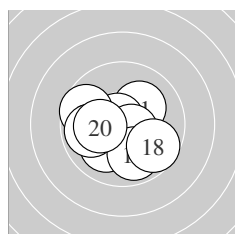

Serie 2:
 10.2 * 10.0 ↙ 10.8 * 10.7 * 9.7 ↖
 10.6 * 9.9 ↓ 9.7 ↘ 9.9 ← 10.2 *
 beste Teiler 32.5 (13.) 56.0 (14.) 92.6 (16.)
 Trefferlage 0.38 mm links, 0.48 mm tief
 Streuwert 1.58, horizontal: 1.85, vertikal: 1.26

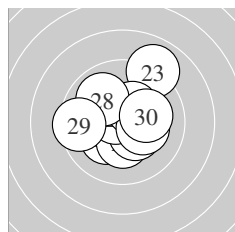

Serie 3:
 10.2 * 10.3 * 9.0 ↗ 10.4 * 10.7 *
 10.4 * 10.2 * 9.9 ↘ 9.5 ← 10.1 →
 beste Teiler 69.3 (25.) 144.2 (26.) 145.0 (24.)
 Trefferlage 0.08 mm rechts, 0.36 mm hoch
 Streuwert 1.85, horizontal: 1.93, vertikal: 1.77

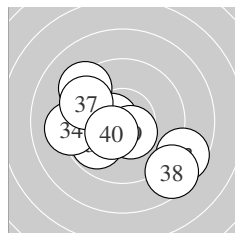

Serie 4:
 10.4 * 9.8 ↙ 8.6 ↘ 9.2 ← 10.6 *
 9.3 ↘ 9.6 ↖ 8.6 ↘ 10.5 * 10.4 *
 beste Teiler 94.4 (35.) 116.0 (39.) 134.3 (40.)
 Trefferlage 0.58 mm links, 0.77 mm tief
 Streuwert 2.60, horizontal: 3.08, vertikal: 2.00

Unterschrift des Schützen

Meyton Elektronik

Ergebnis: **404.2** (387)
 Serien: 100.9 101.3 100.3 101.7
 Zähler: 27 13 0 0 0 0 0 0 0 0
 Innenzehner: 19
 weiteste: 409 (30), 373 (5), 345 (29)
 beste Teiler 35.4 (34.) 66.5 (7.) 72.0 (17.)
 Trefferlage 0.00 mm , 0.95 mm hoch
 Streuwert 1.52, horizontal: 1.87, vertikal: 1.06

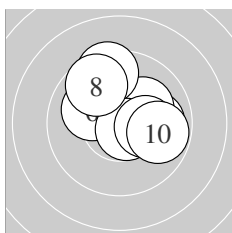
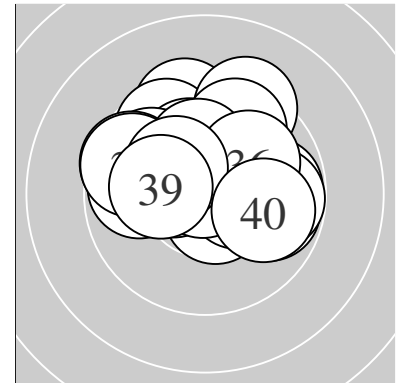

Serie 1:
 10.1 ↘ 10.0 → 10.6 * 10.2 * 9.5 ↑
 10.1 ↘ 10.7 * 9.7 ↘ 10.2 * 9.8 →
 beste Teiler 66.5 (7.) 90.6 (3.) 187.6 (9.)
 Trefferlage 0.25 mm rechts, 0.94 mm hoch
 Streuwert 1.63, horizontal: 1.82, vertikal: 1.40

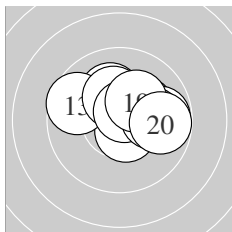

Serie 2:
 10.6 * 10.1 ↑ 9.6 ↘ 10.2 * 10.3 *
 9.8 → 10.7 * 10.0 → 10.2 * 9.8 →
 beste Teiler 72.0 (17.) 90.9 (11.) 171.0 (15.)
 Trefferlage 0.76 mm rechts, 0.70 mm hoch
 Streuwert 1.45, horizontal: 1.86, vertikal: 0.86

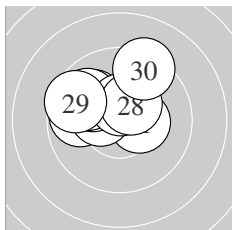

Serie 3:
 10.4 * 10.0 ↘ 9.8 ← 10.4 * 10.0 ↘
 9.9 ↘ 10.5 * 10.4 * 9.6 ↘ 9.3 ↑
 beste Teiler 111.2 (27.) 141.6 (24.) 143.4 (28.)
 Trefferlage 0.96 mm links, 1.21 mm hoch
 Streuwert 1.49, horizontal: 1.83, vertikal: 1.04

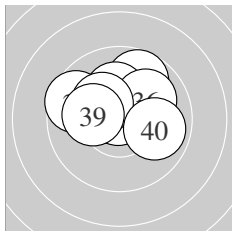

Serie 4:
 10.6 * 9.7 ↑ 10.4 * 10.8 * 10.2 *
 10.0 ↗ 9.6 ↘ 10.3 * 10.2 * 9.9 →
 beste Teiler 35.4 (34.) 88.7 (31.) 148.1 (33.)
 Trefferlage 0.06 mm links, 0.97 mm hoch
 Streuwert 1.43, horizontal: 1.79, vertikal: 0.95

Unterschrift des Schützen

Meyton Elektronik

Ergebnis: **414.0** (393)
 Serien: 105.0 102.4 104.0 102.6
 Zähler: 33 7 0 0 0 0 0 0 0 0
 Innenzehner: 26
 weiteste: 364 (16), 339 (40), 323 (18)
 beste Teiler 13.4 (17.) 20.0 (25.) 23.4 (33.)
 Trefferlage 0.02 mm rechts, 0.42 mm tief
 Streuwert 1.26, horizontal: 1.47, vertikal: 1.00

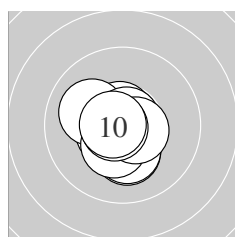
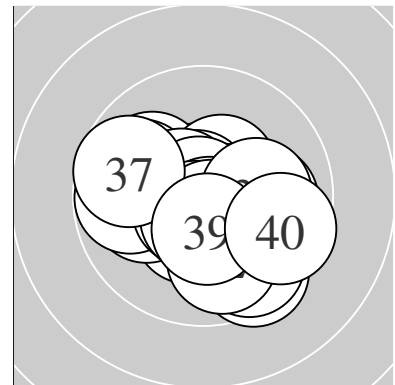

Serie 1:
 10.5 * 10.2 * 10.3 * 10.7 * 10.1 ↖
 10.4 * 10.8 * 10.6 * 10.7 * 10.7 *
 beste Teiler 41.2 (7.) 56.3 (9.) 66.1 (10.)
 Trefferlage 0.31 mm links, 0.38 mm tief
 Streuwert 0.88, horizontal: 0.83, vertikal: 0.94

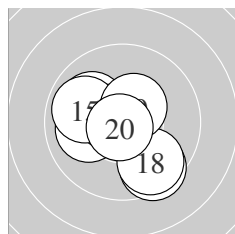

Serie 2:
 10.0 ↘ 10.6 * 10.0 ← 10.6 * 9.9 ↖
 9.5 ↘ 10.9 * 9.7 ↘ 10.4 * 10.8 *
 beste Teiler 13.4 (17.) 40.3 (20.) 79.0 (12.)
 Trefferlage 0.39 mm links, 0.33 mm tief
 Streuwert 1.53, horizontal: 1.62, vertikal: 1.44

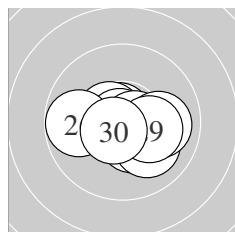

Serie 3:
 10.8 * 10.6 * 10.4 * 10.1 ↘ 10.9 *
 9.8 ← 10.6 * 10.0 → 10.2 * 10.6 *
 beste Teiler 20.0 (25.) 49.6 (21.) 81.2 (27.)
 Trefferlage 0.24 mm rechts, 0.32 mm tief
 Streuwert 1.19, horizontal: 1.57, vertikal: 0.63

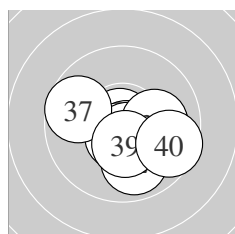

Serie 4:
 10.1 → 9.9 ↘ 10.9 * 10.7 * 10.6 *
 10.6 * 9.7 ↖ 10.1 → 10.4 * 9.6 ↘
 beste Teiler 23.4 (33.) 71.8 (34.) 85.6 (36.)
 Trefferlage 0.55 mm rechts, 0.64 mm tief
 Streuwert 1.39, horizontal: 1.70, vertikal: 0.97

Unterschrift des Schützen

Ergebnis: **410.3** (392)
 Serien: 100.7 102.7 102.8 104.1
 Zähler: 32 8 0 0 0 0 0 0 0 0
 Innenzehner: 25
 weiteste: 395 (29), 374 (1), 347 (10)
 beste Teiler 18.0 (37.) 52.1 (24.) 52.4 (15.)
 Trefferlage 0.59 mm rechts, 0.17 mm tief
 Streuwert 1.35, horizontal: 1.64, vertikal: 0.98

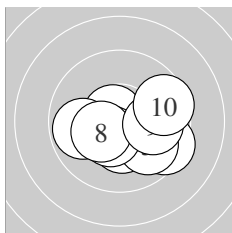
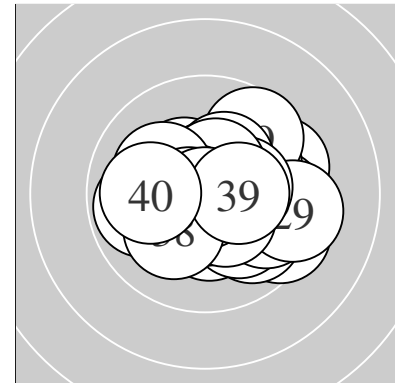

Serie 1:
 9.5 ↘ 10.2 * 10.7 * 10.3 * 9.9 ↘
 9.8 ← 10.4 * 10.3 * 10.0 → 9.6 →
 beste Teiler 65.8 (3.) 130.0 (7.) 155.4 (8.)
 Trefferlage 0.73 mm rechts, 0.74 mm tief
 Streuwert 1.61, horizontal: 2.06, vertikal: 0.97

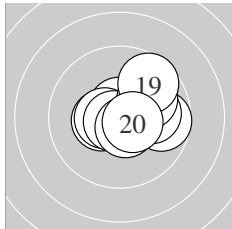

Serie 2:
 9.7 → 10.4 * 10.7 * 10.5 * 10.7 *
 10.0 → 10.6 * 10.0 ↗ 9.6 ↗ 10.5 *
 beste Teiler 52.4 (15.) 70.1 (13.) 86.4 (17.)
 Trefferlage 0.80 mm rechts, 0.27 mm hoch
 Streuwert 1.29, horizontal: 1.54, vertikal: 0.98

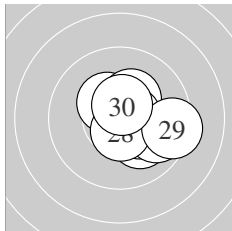

Serie 3:
 10.1 ↘ 10.3 * 9.8 ↘ 10.7 * 10.4 *
 10.3 * 10.6 * 10.6 * 9.4 → 10.6 *
 beste Teiler 52.1 (24.) 83.6 (27.) 93.4 (28.)
 Trefferlage 1.08 mm rechts, 0.18 mm tief
 Streuwert 1.22, horizontal: 1.39, vertikal: 1.02

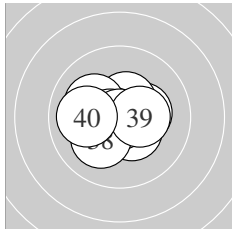

Serie 4:
 10.3 * 10.5 * 10.7 * 10.4 * 10.1 ↘
 10.7 * 10.9 * 10.1 ↗ 10.4 * 10.0 ←
 beste Teiler 18.0 (37.) 58.1 (33.) 73.2 (36.)
 Trefferlage 0.24 mm links, 0.04 mm tief
 Streuwert 1.13, horizontal: 1.39, vertikal: 0.78

Unterschrift des Schützen

Ergebnis: **409.8** (394)
 Serien: 101.8 103.1 102.4 102.5
 Zähler: 34 6 0 0 0 0 0 0 0 0
 Innenzehner: 26
 weiteste: 482 (35), 441 (1), 437 (25)
 beste Teiler 13.0 (16.) 14.1 (30.) 16.6 (5.)
 Trefferlage 0.79 mm links, 0.04 mm tief
 Streuwert 1.43, horizontal: 1.84, vertikal: 0.83

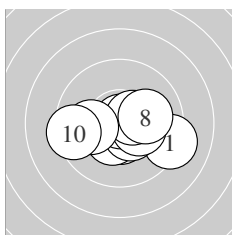
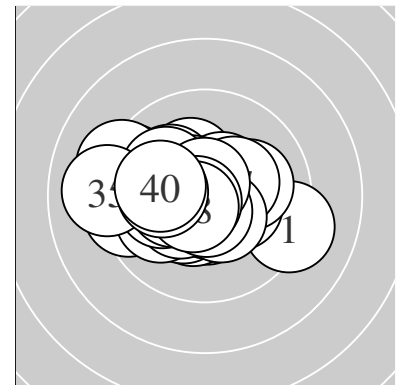

Serie 1:
 9.2 ↘ 10.5 * 10.4 * 10.5 * 10.9 *
 10.3 * 10.5 * 10.1 → 10.0 ← 9.4 ←
 beste Teiler 16.6 (5.) 114.3 (2.) 115.1 (7.)
 Trefferlage 0.32 mm rechts, 0.51 mm tief
 Streuwert 1.66, horizontal: 2.24, vertikal: 0.71

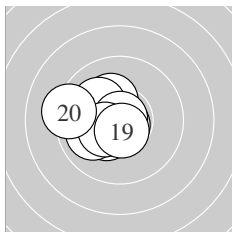

Serie 2:
 10.3 * 10.4 * 10.8 * 10.1 ↘ 10.3 *
 10.9 * 10.0 ← 10.4 * 10.6 * 9.3 ←
 beste Teiler 13.0 (16.) 47.7 (13.) 87.6 (19.)
 Trefferlage 1.17 mm links, 0.08 mm tief
 Streuwert 1.16, horizontal: 1.33, vertikal: 0.98

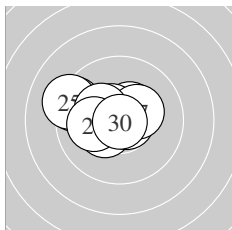

Serie 3:
 10.5 * 10.4 * 9.4 ↘ 10.7 * 9.2 ↘
 10.6 * 10.3 * 10.3 * 10.1 ← 10.9 *
 beste Teiler 14.1 (30.) 60.4 (24.) 99.1 (26.)
 Trefferlage 1.04 mm links, 0.44 mm hoch
 Streuwert 1.43, horizontal: 1.87, vertikal: 0.77

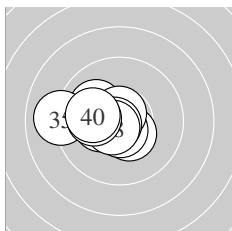

Serie 4:
 10.4 * 10.1 ↘ 10.3 * 10.6 * 9.0 ←
 10.7 * 10.7 * 10.6 * 10.1 ← 10.0 ←
 beste Teiler 52.1 (37.) 62.1 (36.) 76.4 (34.)
 Trefferlage 1.28 mm links, 0.01 mm tief
 Streuwert 1.24, horizontal: 1.61, vertikal: 0.68

Unterschrift des Schützen

Ergebnis: **414.9** (396)
 Serien: 103.3 103.0 104.7 103.9
 Zähler: 36 4 0 0 0 0 0 0 0 0
 Innenzehner: 28
 weiteste: 288 (1), 284 (20), 255 (28)
 beste Teiler 21.9 (29.) 28.6 (21.) 32.5 (35.)
 Trefferlage 0.11 mm rechts, 0.53 mm hoch
 Streuwert 1.10, horizontal: 1.35, vertikal: 0.79

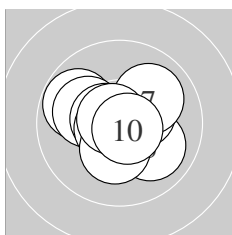
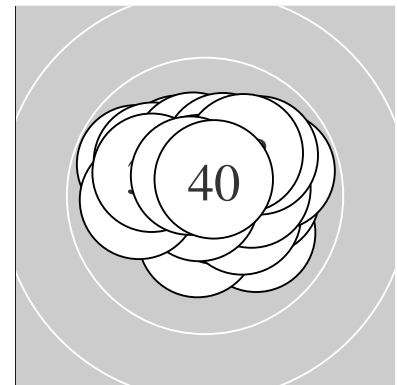

Serie 1:
 9.8 ↙ 10.1 ↙ 10.0 ↘ 10.6 * 10.7 *
 10.4 * 10.0 ↗ 10.3 * 10.7 * 10.7 *
 beste Teiler 53.7 (9.) 60.2 (10.) 72.0 (5.)
 Trefferlage 0.13 mm links, 0.09 mm hoch
 Streuwert 1.31, horizontal: 1.54, vertikal: 1.03

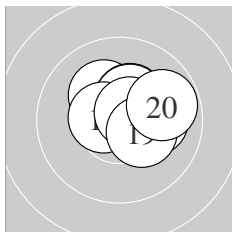

Serie 2:
 10.6 * 10.2 * 10.4 * 10.4 * 10.1 →
 10.5 * 10.1 → 10.6 * 10.3 * 9.8 →
 beste Teiler 77.6 (11.) 80.6 (18.) 102.4 (16.)
 Trefferlage 0.86 mm rechts, 0.62 mm hoch
 Streuwert 1.01, horizontal: 1.25, vertikal: 0.70

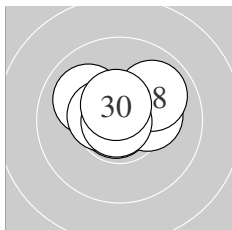

Serie 3:
 10.8 * 10.6 * 10.8 * 10.4 * 10.0 ↘
 10.5 * 10.2 * 9.9 ↗ 10.9 * 10.6 *
 beste Teiler 21.9 (29.) 28.6 (21.) 45.9 (23.)
 Trefferlage 0.06 mm rechts, 0.58 mm hoch
 Streuwert 0.99, horizontal: 1.28, vertikal: 0.57

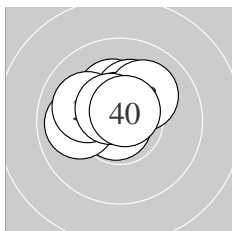

Serie 4:
 10.6 * 10.3 * 10.2 * 10.6 * 10.8 *
 9.9 ← 10.1 ↙ 10.1 ↗ 10.6 * 10.7 *
 beste Teiler 32.5 (35.) 71.1 (40.) 85.3 (34.)
 Trefferlage 0.35 mm links, 0.85 mm hoch
 Streuwert 0.96, horizontal: 1.18, vertikal: 0.68

Unterschrift des Schützen

Meyton Elektronik

Ergebnis: **420.5** (400)
 Serien: 104.1 105.7 104.7 106.0
 Zähler: 40 0 0 0 0 0 0 0 0 0
 Innenzehner: 36
 weiteste: 239 (1), 235 (24), 208 (20)
 beste Teiler 10.1 (12.) 16.2 (35.) 28.4 (33.)
 Trefferlage 0.03 mm links, 0.06 mm tief
 Streuwert 0.88, horizontal: 0.95, vertikal: 0.82

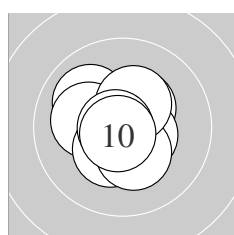
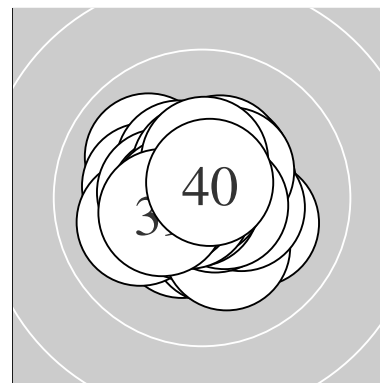

Serie 1:
 10.0 ↘ 10.4 * 10.5 * 10.1 ← 10.5 *
 10.4 * 10.3 * 10.3 * 10.8 * 10.8 *
 beste Teiler 43.1 (9.) 47.8 (10.) 110.5 (5.)
 Trefferlage 0.16 mm links, 0.17 mm hoch
 Streuwert 1.09, horizontal: 1.10, vertikal: 1.07

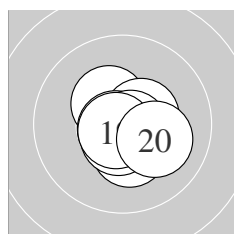

Serie 2:
 10.3 * 10.9 * 10.7 * 10.6 * 10.4 *
 10.5 * 10.8 * 10.7 * 10.7 * 10.1 →
 beste Teiler 10.1 (12.) 50.4 (17.) 53.2 (18.)
 Trefferlage 0.22 mm rechts, 0.28 mm tief
 Streuwert 0.77, horizontal: 0.80, vertikal: 0.74

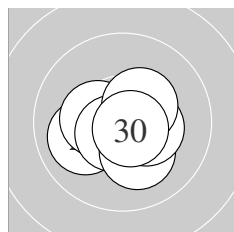

Serie 3:
 10.7 * 10.6 * 10.7 * 10.0 ← 10.4 *
 10.6 * 10.2 * 10.4 * 10.4 * 10.7 *
 beste Teiler 60.3 (30.) 67.4 (23.) 74.7 (21.)
 Trefferlage 0.13 mm rechts, 0.31 mm tief
 Streuwert 0.98, horizontal: 1.16, vertikal: 0.74

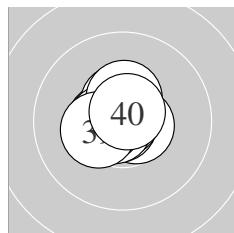

Serie 4:
 10.6 * 10.5 * 10.8 * 10.5 * 10.9 *
 10.7 * 10.6 * 10.4 * 10.3 * 10.7 *
 beste Teiler 16.2 (35.) 28.4 (33.) 54.5 (36.)
 Trefferlage 0.32 mm links, 0.17 mm hoch
 Streuwert 0.64, horizontal: 0.67, vertikal: 0.61

Unterschrift des Schützen

Ergebnis: **406.7** (391)
 Serien: 101.4 101.5 103.0 100.8
 Zähler: 31 9 0 0 0 0 0 0 0 0
 Innenzehner: 21
 weiteste: 500 (9), 486 (14), 444 (40)
 beste Teiler 28.6 (10.) 33.2 (5.) 34.6 (36.)
 Trefferlage 0.58 mm rechts, 0.13 mm hoch
 Streuwert 1.60, horizontal: 1.77, vertikal: 1.40

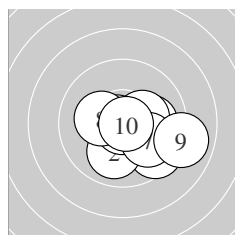
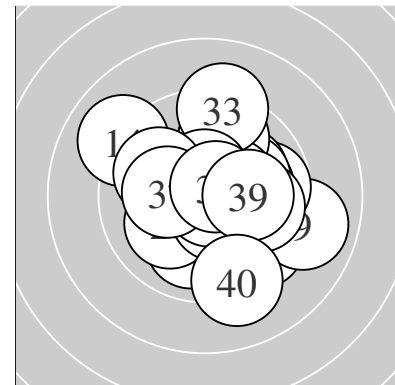

Serie 1:
 9.5 ↘ 10.0 ↓ 10.8 * 10.0 → 10.8 *
 10.3 * 10.0 ↘ 10.2 * 9.0 → 10.8 *
 beste Teiler 28.6 (10.) 33.2 (5.) 46.5 (3.)
 Trefferlage 1.08 mm rechts, 0.67 mm tief
 Streuwert 1.58, horizontal: 1.96, vertikal: 1.07

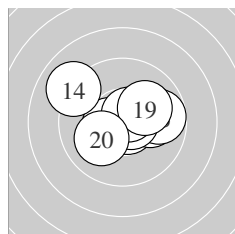

Serie 2:
 10.7 * 10.5 * 10.0 → 9.0 ↘ 10.0 →
 9.8 → 10.7 * 10.6 * 10.1 ↗ 10.1 ↖
 beste Teiler 58.0 (11.) 71.0 (17.) 79.0 (18.)
 Trefferlage 0.40 mm rechts, 0.39 mm hoch
 Streuwert 1.70, horizontal: 2.15, vertikal: 1.08

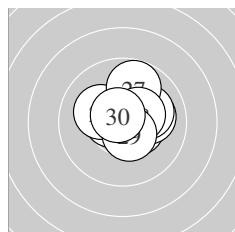

Serie 3:
 10.4 * 10.6 * 10.2 * 10.2 * 10.1 →
 10.1 → 9.8 ↑ 10.4 * 10.5 * 10.7 *
 beste Teiler 69.6 (30.) 94.5 (22.) 110.6 (29.)
 Trefferlage 0.65 mm rechts, 0.56 mm hoch
 Streuwert 1.16, horizontal: 1.30, vertikal: 0.99

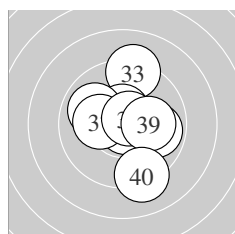

Serie 4:
 9.9 → 10.3 * 9.2 ↑ 10.5 * 9.9 ↘
 10.8 * 10.2 * 10.7 * 10.1 → 9.2 ↓
 beste Teiler 34.6 (36.) 68.7 (38.) 103.0 (34.)
 Trefferlage 0.21 mm rechts, 0.25 mm hoch
 Streuwert 1.89, horizontal: 1.70, vertikal: 2.06

Unterschrift des Schützen

Meyton Elektronik

Ergebnis: **405.1** (386)
 Serien: 103.2 101.0 99.8 101.1
 Zähler: 27 12 1 0 0 0 0 0 0 0
 Innenzehner: 22
 weiteste: 570 (13), 420 (40), 373 (26)
 beste Teiler 48.6 (20.) 66.8 (17.) 70.8 (8.)
 Trefferlage 0.46 mm links, 0.31 mm tief
 Streuwert 1.64, horizontal: 1.99, vertikal: 1.19

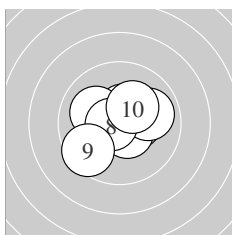
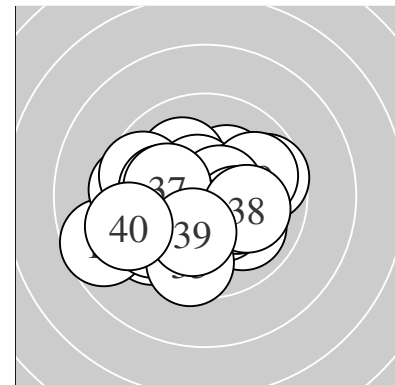

Serie 1:
 10.4 * 10.7 * 10.5 * 10.6 * 10.6 *
 10.1 ↖ 9.9 → 10.7 * 9.5 ↙ 10.2 *
 beste Teiler 70.8 (8.) 72.1 (2.) 84.0 (5.)
 Trefferlage 0.00 mm , 0.16 mm hoch
 Streuwert 1.35, horizontal: 1.57, vertikal: 1.08

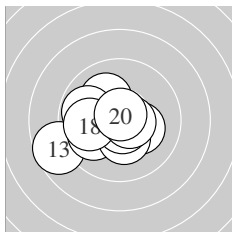

Serie 2:
 10.1 ↖ 9.8 ← 8.7 ↙ 9.9 ↙ 10.2 *
 10.3 * 10.7 * 9.9 ← 10.6 * 10.8 *
 beste Teiler 48.6 (20.) 66.8 (17.) 87.6 (19.)
 Trefferlage 1.06 mm links, 0.40 mm tief
 Streuwert 1.70, horizontal: 2.09, vertikal: 1.19

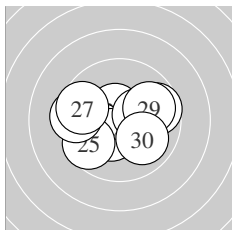

Serie 3:
 10.6 * 9.7 → 10.2 * 10.4 * 9.6 ↙
 9.5 ← 9.6 ← 10.3 * 9.9 → 10.0 ↘
 beste Teiler 97.1 (21.) 143.6 (24.) 167.7 (28.)
 Trefferlage 0.32 mm links, 0.08 mm tief
 Streuwert 1.95, horizontal: 2.50, vertikal: 1.18

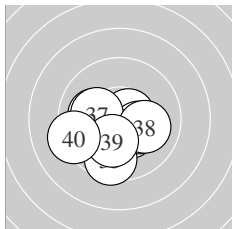

Serie 4:
 10.4 * 10.6 * 10.2 * 10.1 ↖ 9.6 ↓
 10.4 * 10.2 * 10.1 → 10.2 * 9.3 ←
 beste Teiler 82.3 (32.) 139.2 (36.) 141.6 (31.)
 Trefferlage 0.46 mm links, 0.94 mm tief
 Streuwert 1.57, horizontal: 1.87, vertikal: 1.19

Unterschrift des Schützen

Meyton Elektronik

Ergebnis: **419.5** (398)
 Serien: 105.3 104.6 105.3 104.3
 Zähler: 38 2 0 0 0 0 0 0 0 0
 Innenzehner: 37
 weiteste: 262 (34), 253 (35), 210 (2)
 beste Teiler 36.4 (30.) 39.0 (8.) 42.0 (4.)
 Trefferlage 0.15 mm links, 0.17 mm hoch
 Streuwert 0.90, horizontal: 1.09, vertikal: 0.66

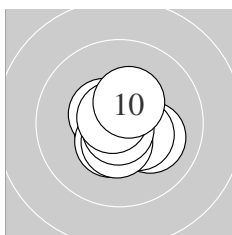
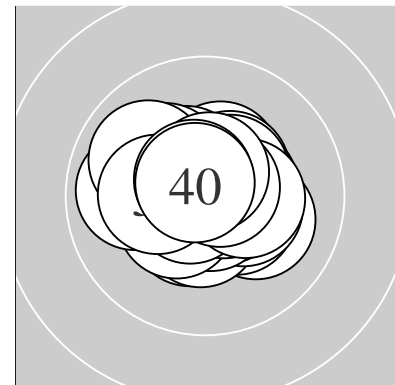

Serie 1:
 10.7 * 10.1 ↘ 10.5 * 10.8 * 10.4 *
 10.4 * 10.5 * 10.8 * 10.7 * 10.4 *
 beste Teiler 39.0 (8.) 42.0 (4.) 56.2 (9.)
 Trefferlage 0.06 mm rechts, 0.21 mm tief
 Streuwert 0.86, horizontal: 0.90, vertikal: 0.83

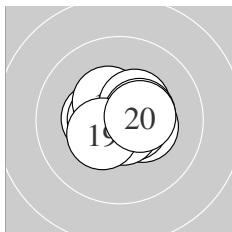

Serie 2:
 10.4 * 10.4 * 10.6 * 10.5 * 10.7 *
 10.4 * 10.4 * 10.4 * 10.4 * 10.4 *
 beste Teiler 61.6 (15.) 86.0 (13.) 104.1 (14.)
 Trefferlage 0.16 mm rechts, 0.07 mm hoch
 Streuwert 0.91, horizontal: 1.12, vertikal: 0.64

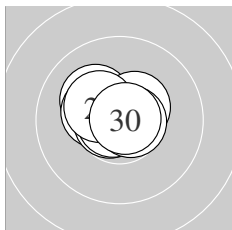

Serie 3:
 10.5 * 10.2 * 10.5 * 10.3 * 10.5 *
 10.7 * 10.8 * 10.3 * 10.7 * 10.8 *
 beste Teiler 36.4 (30.) 43.7 (27.) 64.5 (26.)
 Trefferlage 0.35 mm links, 0.45 mm hoch
 Streuwert 0.77, horizontal: 0.97, vertikal: 0.48

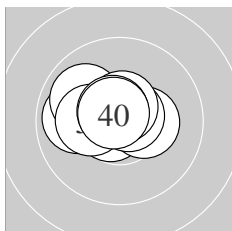

Serie 4:
 10.6 * 10.7 * 10.3 * 9.9 ← 9.9 ↘
 10.7 * 10.2 * 10.6 * 10.7 * 10.7 *
 beste Teiler 62.8 (40.) 63.5 (32.) 65.8 (36.)
 Trefferlage 0.47 mm links, 0.37 mm hoch
 Streuwert 1.02, horizontal: 1.35, vertikal: 0.49

Unterschrift des Schützen

Meyton Elektronik

Ergebnis: **420.7** (399)
 Serien: 105.3 105.9 104.1 105.4
 Zähler: 39 1 0 0 0 0 0 0 0 0
 Innenzehner: 39
 weiteste: 294 (27), 199 (13), 171 (10)
 beste Teiler 35.0 (5.) 35.0 (15.) 37.6 (4.)
 Trefferlage 0.30 mm rechts, 0.40 mm tief
 Streuwert 0.79, horizontal: 0.82, vertikal: 0.75

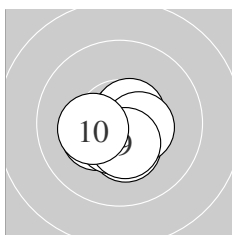
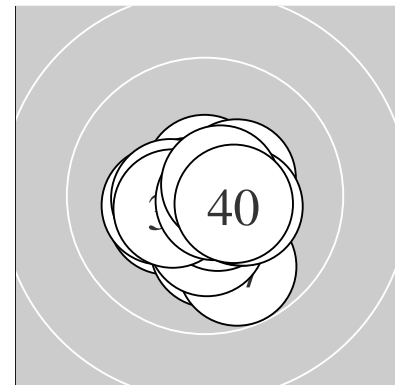

Serie 1:
 10.3 * 10.3 * 10.8 * 10.8 * 10.8 *
 10.6 * 10.5 * 10.5 * 10.4 * 10.3 *
 beste Teiler 35.0 (5.) 37.6 (4.) 45.6 (3.)
 Trefferlage 0.01 mm links, 0.47 mm tief
 Streuwert 0.79, horizontal: 0.91, vertikal: 0.64

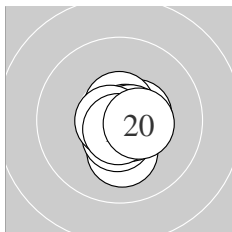

Serie 2:
 10.5 * 10.6 * 10.2 * 10.5 * 10.8 *
 10.7 * 10.7 * 10.7 * 10.7 * 10.5 *
 beste Teiler 35.0 (15.) 57.7 (19.) 59.1 (18.)
 Trefferlage 0.32 mm rechts, 0.30 mm tief
 Streuwert 0.68, horizontal: 0.57, vertikal: 0.77

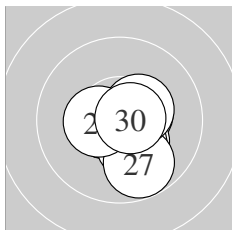

Serie 3:
 10.6 * 10.5 * 10.5 * 10.3 * 10.6 *
 10.3 * 9.8 ↘ 10.4 * 10.4 * 10.7 *
 beste Teiler 69.0 (30.) 88.5 (21.) 93.7 (25.)
 Trefferlage 0.38 mm rechts, 0.44 mm tief
 Streuwert 1.03, horizontal: 1.00, vertikal: 1.07

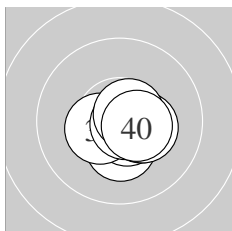

Serie 4:
 10.7 * 10.3 * 10.7 * 10.6 * 10.4 *
 10.8 * 10.4 * 10.3 * 10.7 * 10.5 *
 beste Teiler 41.5 (36.) 66.0 (31.) 72.2 (39.)
 Trefferlage 0.54 mm rechts, 0.38 mm tief
 Streuwert 0.65, horizontal: 0.76, vertikal: 0.52

Unterschrift des Schützen

Meyton Elektronik

Ergebnis: **423.5** (400)
 Serien: 106.4 105.7 105.6 105.8
 Zähler: 40 0 0 0 0 0 0 0 0 0
 Innenzehner: 39
 weiteste: 210 (1), 193 (29), 186 (13)
 beste Teiler 5.3 (10.) 17.0 (9.) 30.8 (19.)
 Trefferlage 0.23 mm rechts, 0.08 mm tief
 Streuwert 0.72, horizontal: 0.82, vertikal: 0.60

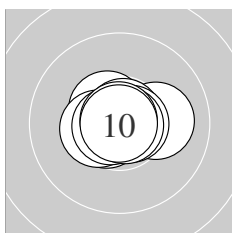
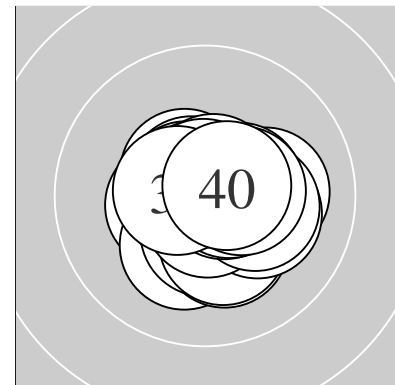

Serie 1:
 10.1 → 10.5 * 10.6 * 10.8 * 10.4 *
 10.7 * 10.7 * 10.8 * 10.9 * 10.9 *
 beste Teiler 5.3 (10.) 17.0 (9.) 32.8 (8.)
 Trefferlage 0.01 mm links, 0.04 mm hoch
 Streuwert 0.70, horizontal: 0.93, vertikal: 0.34

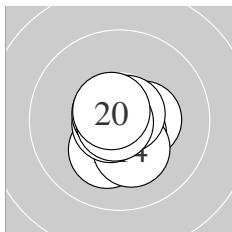

Serie 2:
 10.4 * 10.6 * 10.2 * 10.2 * 10.7 *
 10.7 * 10.7 * 10.7 * 10.8 * 10.7 *
 beste Teiler 30.8 (19.) 53.8 (18.) 57.1 (16.)
 Trefferlage 0.01 mm links, 0.28 mm tief
 Streuwert 0.76, horizontal: 0.69, vertikal: 0.83

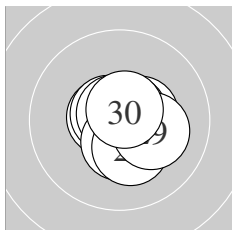

Serie 3:
 10.6 * 10.7 * 10.5 * 10.7 * 10.8 *
 10.4 * 10.7 * 10.3 * 10.2 * 10.7 *
 beste Teiler 46.6 (25.) 60.4 (24.) 64.6 (27.)
 Trefferlage 0.32 mm rechts, 0.09 mm tief
 Streuwert 0.79, horizontal: 0.81, vertikal: 0.77

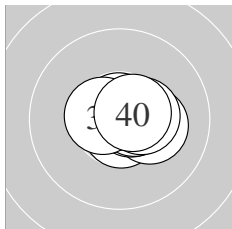

Serie 4:
 10.5 * 10.7 * 10.7 * 10.2 * 10.7 *
 10.6 * 10.4 * 10.8 * 10.6 * 10.6 *
 beste Teiler 44.4 (38.) 60.6 (33.) 65.1 (35.)
 Trefferlage 0.62 mm rechts, 0.00 mm
 Streuwert 0.59, horizontal: 0.77, vertikal: 0.33

Unterschrift des Schützen

Meyton Elektronik

Ergebnis: **421.5** (400)
 Serien: 104.9 105.6 105.7 105.3
 Zähler: 40 0 0 0 0 0 0 0 0 0
 Innenzehner: 39
 weiteste: 206 (16), 175 (32), 174 (37)
 beste Teiler 28.0 (17.) 28.8 (39.) 35.0 (25.)
 Trefferlage 0.02 mm rechts, 0.26 mm hoch
 Streuwert 0.78, horizontal: 0.82, vertikal: 0.74

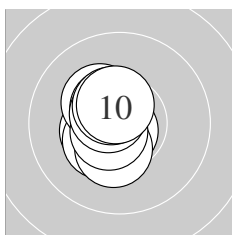
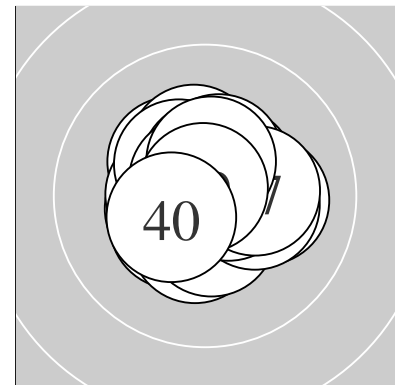

Serie 1:
 10.4 * 10.4 * 10.8 * 10.3 * 10.3 *
 10.6 * 10.5 * 10.6 * 10.5 * 10.5 *
 beste Teiler 43.0 (3.) 77.8 (6.) 85.2 (8.)
 Trefferlage 0.64 mm links, 0.08 mm hoch
 Streuwert 0.73, horizontal: 0.40, vertikal: 0.96

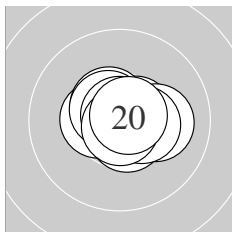

Serie 2:
 10.6 * 10.5 * 10.5 * 10.6 * 10.6 *
 10.1 → 10.8 * 10.4 * 10.8 * 10.7 *
 beste Teiler 28.0 (17.) 38.2 (19.) 57.7 (20.)
 Trefferlage 0.27 mm rechts, 0.08 mm hoch
 Streuwert 0.77, horizontal: 0.98, vertikal: 0.48

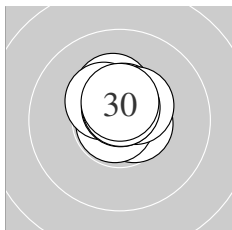

Serie 3:
 10.3 * 10.7 * 10.6 * 10.5 * 10.8 *
 10.5 * 10.4 * 10.7 * 10.7 * 10.5 *
 beste Teiler 35.0 (25.) 63.8 (22.) 71.1 (28.)
 Trefferlage 0.09 mm rechts, 0.71 mm hoch
 Streuwert 0.56, horizontal: 0.55, vertikal: 0.57

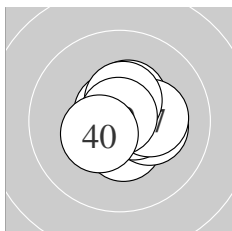

Serie 4:
 10.5 * 10.3 * 10.6 * 10.8 * 10.4 *
 10.7 * 10.3 * 10.5 * 10.8 * 10.4 *
 beste Teiler 28.8 (39.) 49.6 (34.) 65.8 (36.)
 Trefferlage 0.37 mm rechts, 0.16 mm hoch
 Streuwert 0.84, horizontal: 0.89, vertikal: 0.79

Unterschrift des Schützen

Ergebnis: **414.9** (394)
 Serien: 104.0 103.1 105.9 101.9
 Zähler: 35 4 1 0 0 0 0 0 0 0
 Innenzehner: 30
 weiteste: 508 (33), 308 (14), 285 (15)
 beste Teiler 11.0 (12.) 26.8 (16.) 32.3 (5.)
 Trefferlage 0.04 mm links, 0.07 mm hoch
 Streuwert 1.25, horizontal: 1.57, vertikal: 0.80

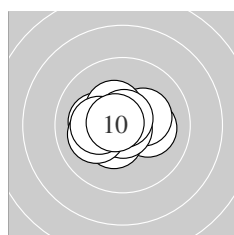
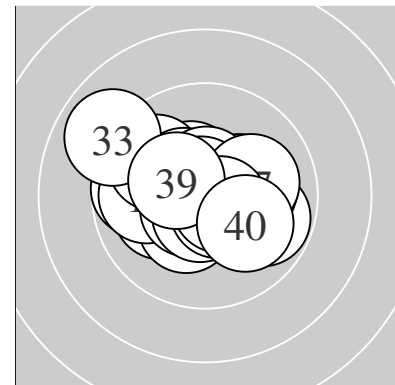

Serie 1:
 10.2 * 10.2 * 10.4 * 10.3 * 10.8 *
 10.4 * 10.7 * 10.1 ← 10.2 * 10.7 *
 beste Teiler 32.3 (5.) 53.1 (7.) 61.0 (10.)
 Trefferlage 0.40 mm links, 0.04 mm hoch
 Streuwert 1.09, horizontal: 1.39, vertikal: 0.68

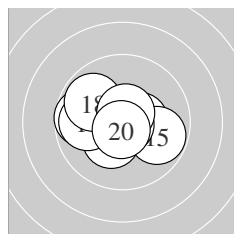

Serie 2:
 10.4 * 10.9 * 10.3 * 9.7 ← 9.8 →
 10.8 * 9.9 ← 9.9 ↖ 10.7 * 10.7 *
 beste Teiler 11.0 (12.) 26.8 (16.) 59.0 (20.)
 Trefferlage 0.45 mm links, 0.04 mm tief
 Streuwert 1.41, horizontal: 1.81, vertikal: 0.83

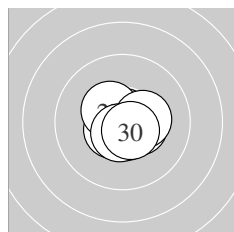

Serie 3:
 10.8 * 10.6 * 10.4 * 10.6 * 10.8 *
 10.8 * 10.4 * 10.3 * 10.6 * 10.6 *
 beste Teiler 37.0 (21.) 37.4 (26.) 50.4 (25.)
 Trefferlage 0.25 mm rechts, 0.20 mm tief
 Streuwert 0.69, horizontal: 0.80, vertikal: 0.56

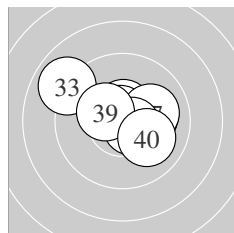

Serie 4:
 10.4 * 10.1 → 8.9 ↘ 10.1 → 10.6 *
 10.7 * 10.1 → 10.6 * 10.4 * 10.0 ↘
 beste Teiler 55.0 (36.) 81.4 (38.) 98.1 (35.)
 Trefferlage 0.44 mm rechts, 0.49 mm hoch
 Streuwert 1.61, horizontal: 2.03, vertikal: 1.02

Unterschrift des Schützen

Meyton Elektronik

Ergebnis: **402.3** (385)
 Serien: 100.5 102.6 100.0 99.2
 Zähler: 27 11 2 0 0 0 0 0 0 0
 Innenzehner: 18
 weiteste: 539 (30), 519 (10), 437 (40)
 beste Teiler 12.3 (15.) 55.9 (18.) 58.3 (6.)
 Trefferlage 0.05 mm rechts, 0.72 mm tief
 Streuwert 1.76, horizontal: 2.05, vertikal: 1.41

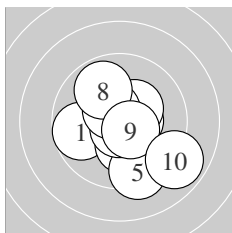
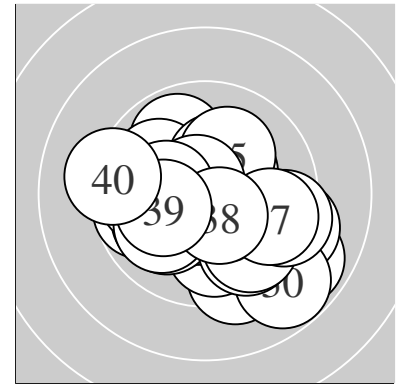

Serie 1:
 9.7 ← 10.2 * 10.5 * 10.3 * 9.3 ↓
 10.7 * 10.5 * 9.9 ↘ 10.5 * 8.9 ↘
 beste Teiler 58.3 (6.) 106.4 (7.) 108.2 (9.)
 Trefferlage 0.42 mm rechts, 0.63 mm tief
 Streuwert 1.89, horizontal: 1.90, vertikal: 1.88

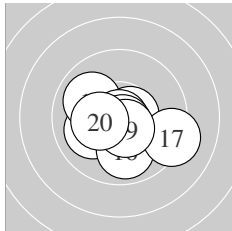

Serie 2:
 10.0 ← 10.4 * 10.0 ↘ 10.6 * 10.9 *
 9.9 ↓ 9.2 ↘ 10.7 * 10.6 * 10.3 *
 beste Teiler 12.3 (15.) 55.9 (18.) 83.0 (14.)
 Trefferlage 0.13 mm links, 0.56 mm tief
 Streuwert 1.49, horizontal: 1.85, vertikal: 1.02

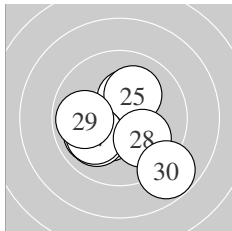

Serie 3:
 10.5 * 10.0 ← 10.4 * 10.3 * 10.1 ↗
 10.0 ← 10.0 ← 10.0 ↘ 9.9 ← 8.8 ↘
 beste Teiler 108.2 (21.) 140.4 (23.) 156.8 (24.)
 Trefferlage 0.18 mm links, 0.84 mm tief
 Streuwert 1.85, horizontal: 2.03, vertikal: 1.65

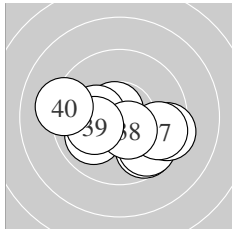

Serie 4:
 9.7 ↘ 9.7 ↘ 9.4 → 10.7 * 10.2 *
 10.0 ← 9.7 → 10.5 * 10.1 ← 9.2 ←
 beste Teiler 63.4 (34.) 121.2 (38.) 182.4 (35.)
 Trefferlage 0.09 mm rechts, 0.85 mm tief
 Streuwert 2.00, horizontal: 2.60, vertikal: 1.11

Unterschrift des Schützen

Meyton Elektronik

Ergebnis: **404.0** (384)
 Serien: 100.2 100.8 101.9 101.1
 Zähler: 26 12 2 0 0 0 0 0 0 0
 Innenzehner: 21
 weiteste: 561 (19), 506 (2), 421 (3)
 beste Teiler 10.0 (25.) 54.0 (5.) 62.8 (11.)
 Trefferlage 0.02 mm links, 0.11 mm tief
 Streuwert 1.73, horizontal: 2.14, vertikal: 1.17

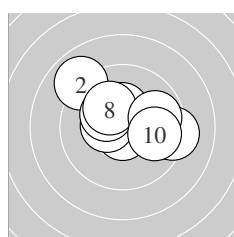
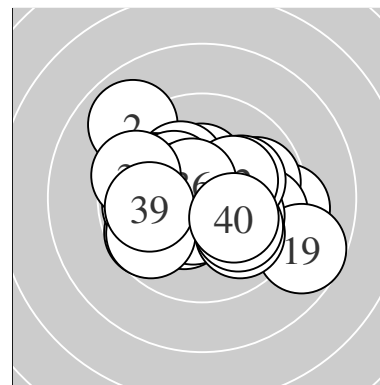

Serie 1:
 10.3 * 8.9 ↘ 9.3 → 10.4 * 10.7 *
 10.4 * 10.3 * 10.2 * 9.8 → 9.9 →
 beste Teiler 54.0 (5.) 130.7 (6.) 149.0 (4.)
 Trefferlage 0.40 mm rechts, 0.72 mm hoch
 Streuwert 1.91, horizontal: 2.36, vertikal: 1.33

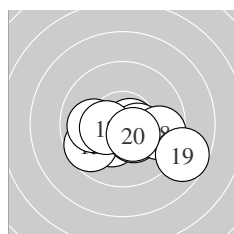

Serie 2:
 10.7 * 10.3 * 9.7 ↙ 10.4 * 10.0 ←
 10.4 * 10.4 * 9.7 → 8.7 ↘ 10.5 *
 beste Teiler 62.8 (11.) 123.0 (20.) 134.4 (16.)
 Trefferlage 0.44 mm rechts, 0.92 mm tief
 Streuwert 1.78, horizontal: 2.40, vertikal: 0.77

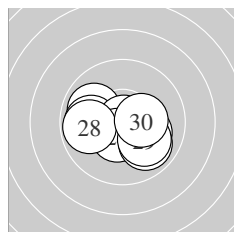

Serie 3:
 10.1 ↘ 9.9 ↖ 10.6 * 9.9 ← 10.9 *
 10.5 * 9.9 ↘ 9.8 ← 10.0 ↘ 10.3 *
 beste Teiler 10.0 (25.) 85.5 (23.) 118.8 (26.)
 Trefferlage 0.10 mm links, 0.53 mm tief
 Streuwert 1.49, horizontal: 1.93, vertikal: 0.84

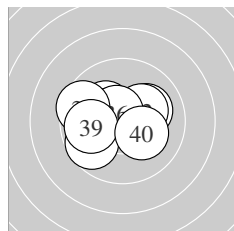

Serie 4:
 10.1 → 10.2 * 10.1 ↖ 10.2 * 10.5 *
 10.6 * 9.7 ↙ 9.6 ↖ 9.9 ← 10.2 *
 beste Teiler 89.8 (36.) 118.0 (35.) 179.4 (32.)
 Trefferlage 0.82 mm links, 0.28 mm hoch
 Streuwert 1.54, horizontal: 1.93, vertikal: 1.01

Unterschrift des Schützen

Meyton Elektronik