

Ergebnis: **413.7** (393)
 Serien: 103.7 102.6 104.0 103.4
 Zähler: 33 7 0 0 0 0 0 0 0 0
 Innenzehner: 30
 weiteste: 407 (14), 370 (13), 361 (22)
 beste Teiler 27.5 (8.) 36.2 (24.) 36.4 (12.)
 Trefferlage 0.20 mm links, 0.41 mm hoch
 Streuwert 1.27, horizontal: 1.52, vertikal: 0.96

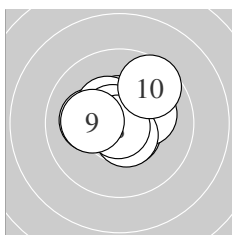

Serie 1:
 10.6 * 10.2 * 10.6 * 10.5 * 10.1 ←
 10.4 * 10.7 * 10.8 * 10.2 * 9.6 ↗
 beste Teiler 27.5 (8.) 68.5 (7.) 96.8 (1.)
 Trefferlage 0.04 mm links, 0.44 mm hoch
 Streuwert 1.21, horizontal: 1.38, vertikal: 1.00

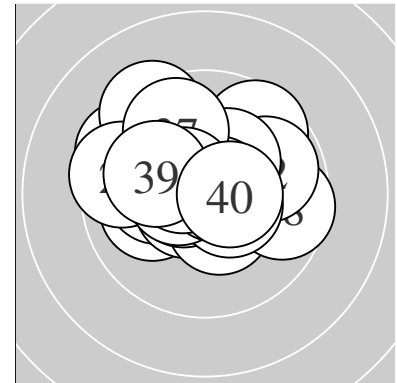
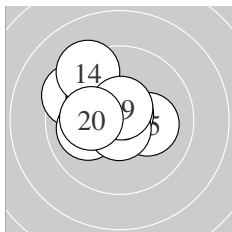

Serie 2:
 10.5 * 10.8 * 9.5 ↖ 9.3 ↖ 10.2 *
 10.8 * 10.0 ← 10.7 * 10.6 * 10.2 *
 beste Teiler 36.4 (12.) 45.5 (16.) 61.0 (18.)
 Trefferlage 0.86 mm links, 0.59 mm hoch
 Streuwert 1.40, horizontal: 1.56, vertikal: 1.22

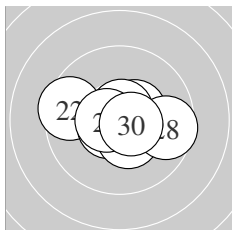

Serie 3:
 10.7 * 9.5 ↖ 10.5 * 10.8 * 10.7 *
 10.6 * 10.4 * 9.6 → 10.6 * 10.6 *
 beste Teiler 36.2 (24.) 58.0 (21.) 65.3 (25.)
 Trefferlage 0.02 mm links, 0.06 mm tief
 Streuwert 1.30, horizontal: 1.73, vertikal: 0.62

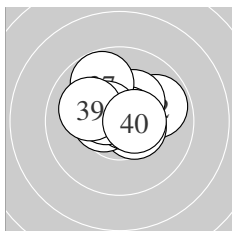

Serie 4:
 10.7 * 9.8 → 10.5 * 10.5 * 10.3 *
 10.7 * 9.8 ↖ 10.5 * 10.1 ↖ 10.5 *
 beste Teiler 53.3 (36.) 66.7 (31.) 105.0 (40.)
 Trefferlage 0.11 mm rechts, 0.68 mm hoch
 Streuwert 1.18, horizontal: 1.41, vertikal: 0.88

Unterschrift des Schützen

Meyton Elektronik

Ergebnis: **401.8** (382)
 Serien: 98.9 100.4 99.6 102.9
 Zähler: 23 16 1 0 0 0 0 0 0 0
 Innenzehner: 18
 weiteste: 519 (23), 426 (24), 421 (19)
 beste Teiler 62.9 (26.) 64.2 (37.) 64.8 (25.)
 Trefferlage 1.02 mm links, 0.81 mm hoch
 Streuwert 1.56, horizontal: 1.67, vertikal: 1.43

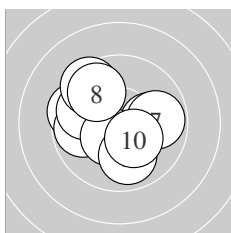
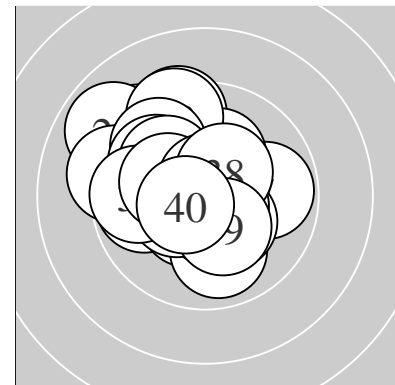

Serie 1:
 9.6 ← 9.8 ← 10.0 → 9.8 ↖ 10.4 *
 9.5 ↘ 9.8 → 9.8 ↘ 9.9 ↓ 10.3 *
 beste Teiler 130.0 (5.) 159.9 (10.) 229.2 (3.)
 Trefferlage 0.68 mm links, 0.23 mm hoch
 Streuwert 1.95, horizontal: 2.23, vertikal: 1.62

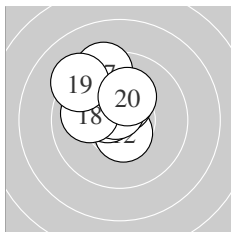

Serie 2:
 9.6 ↘ 10.5 * 10.5 * 9.9 ↖ 10.4 *
 10.6 * 9.4 ↖ 10.0 ← 9.3 ↘ 10.2 *
 beste Teiler 83.0 (16.) 102.2 (12.) 104.3 (13.)
 Trefferlage 1.05 mm links, 1.47 mm hoch
 Streuwert 1.34, horizontal: 1.26, vertikal: 1.41

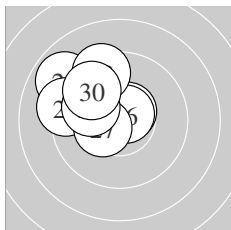

Serie 3:
 10.6 * 10.0 ↘ 8.9 ↖ 9.2 ← 10.7 *
 10.7 * 10.4 * 9.4 ↖ 10.0 ↖ 9.7 ↘
 beste Teiler 62.9 (26.) 64.8 (25.) 89.9 (21.)
 Trefferlage 1.68 mm links, 1.30 mm hoch
 Streuwert 1.48, horizontal: 1.64, vertikal: 1.31

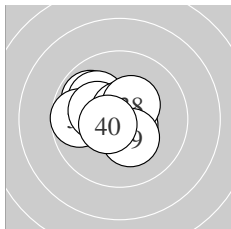

Serie 4:
 9.9 ↘ 10.0 ↘ 9.7 ← 10.2 * 10.5 *
 10.6 * 10.7 * 10.4 * 10.3 * 10.6 *
 beste Teiler 64.2 (37.) 84.8 (36.) 99.8 (40.)
 Trefferlage 0.67 mm links, 0.22 mm hoch
 Streuwert 1.25, horizontal: 1.46, vertikal: 1.01

Unterschrift des Schützen

Meyton Elektronik

Ergebnis: **409.5** (391)
 Serien: 101.8 103.0 100.9 103.8
 Zähler: 31 9 0 0 0 0 0 0 0 0
 Innenzehner: 27
 weiteste: 445 (5), 439 (7), 358 (22)
 beste Teiler 44.0 (40.) 46.6 (31.) 50.4 (20.)
 Trefferlage 0.02 mm links, 0.54 mm tief
 Streuwert 1.44, horizontal: 1.66, vertikal: 1.18

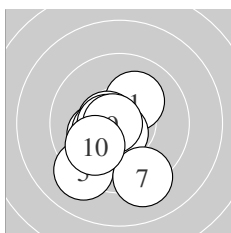
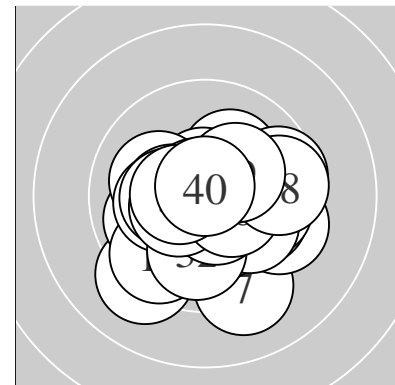

Serie 1:
 10.2 * 10.6 * 10.2 * 10.4 * 9.2 ↙
 10.7 * 9.2 ↓ 10.6 * 10.7 * 10.0 ↙
 beste Teiler 53.1 (9.) 75.5 (6.) 94.3 (2.)
 Trefferlage 0.72 mm links, 0.96 mm tief
 Streuwert 1.55, horizontal: 1.36, vertikal: 1.72

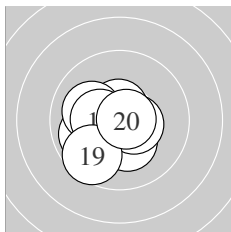

Serie 2:
 9.9 ↙ 10.4 * 10.6 * 10.1 ↖ 10.4 *
 10.3 * 10.4 * 10.5 * 9.6 ↙ 10.8 *
 beste Teiler 50.4 (20.) 84.4 (13.) 112.3 (18.)
 Trefferlage 0.66 mm links, 0.58 mm tief
 Streuwert 1.21, horizontal: 1.33, vertikal: 1.08

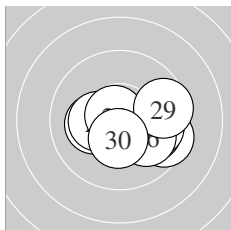

Serie 3:
 10.4 * 9.5 → 9.9 → 9.9 → 10.2 *
 10.0 ↘ 10.3 * 10.7 * 9.6 → 10.4 *
 beste Teiler 52.3 (28.) 131.6 (21.) 138.4 (30.)
 Trefferlage 0.83 mm rechts, 0.46 mm tief
 Streuwert 1.58, horizontal: 2.10, vertikal: 0.75

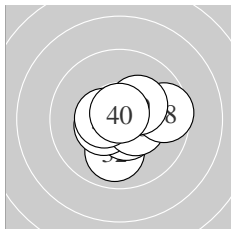

Serie 4:
 10.8 * 10.0 ↓ 10.6 * 10.4 * 10.4 *
 10.4 * 10.5 * 9.6 → 10.3 * 10.8 *
 beste Teiler 44.0 (40.) 46.6 (31.) 99.4 (33.)
 Trefferlage 0.45 mm rechts, 0.17 mm tief
 Streuwert 1.21, horizontal: 1.37, vertikal: 1.01

Unterschrift des Schützen

Ergebnis: **416.8** (400)
 Serien: 103.9 104.3 103.8 104.8
 Zähler: 40 0 0 0 0 0 0 0 0 0
 Innenzehner: 36
 weiteste: 249 (21), 239 (13), 235 (1)
 beste Teiler 34.8 (33.) 46.8 (11.) 53.2 (14.)
 Trefferlage 0.20 mm rechts, 0.11 mm tief
 Streuwert 1.01, horizontal: 1.20, vertikal: 0.78

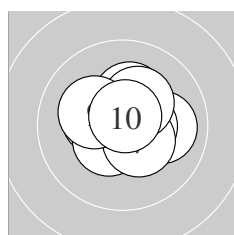
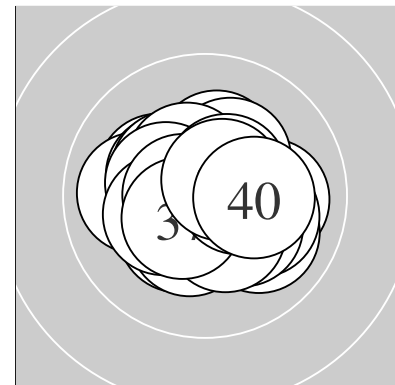

Serie 1:
 10.0 → 10.3 * 10.5 * 10.3 * 10.7 *
 10.5 * 10.4 * 10.3 * 10.2 * 10.7 *
 beste Teiler 57.2 (10.) 63.1 (5.) 113.2 (3.)
 Trefferlage 0.25 mm rechts, 0.29 mm hoch
 Streuwert 1.08, horizontal: 1.27, vertikal: 0.85

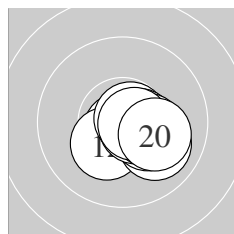

Serie 2:
 10.8 * 10.3 * 10.0 ↘ 10.7 * 10.3 *
 10.6 * 10.5 * 10.3 * 10.7 * 10.1 →
 beste Teiler 46.8 (11.) 53.2 (14.) 72.8 (19.)
 Trefferlage 0.89 mm rechts, 0.54 mm tief
 Streuwert 0.76, horizontal: 0.94, vertikal: 0.51

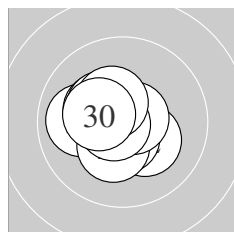

Serie 3:
 10.0 ← 10.2 * 10.3 * 10.3 * 10.6 *
 10.3 * 10.7 * 10.7 * 10.4 * 10.3 *
 beste Teiler 54.8 (28.) 65.9 (27.) 92.1 (25.)
 Trefferlage 0.63 mm links, 0.00 mm
 Streuwert 1.01, horizontal: 1.11, vertikal: 0.90

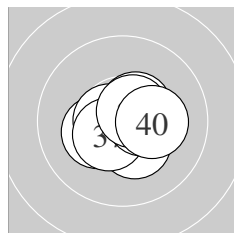

Serie 4:
 10.5 * 10.4 * 10.8 * 10.3 * 10.6 *
 10.4 * 10.5 * 10.5 * 10.6 * 10.2 *
 beste Teiler 34.8 (33.) 81.0 (35.) 87.0 (39.)
 Trefferlage 0.30 mm rechts, 0.22 mm tief
 Streuwert 0.89, horizontal: 1.08, vertikal: 0.65

Unterschrift des Schützen

Meyton Elektronik

Ergebnis: **413.0** (395)
 Serien: 102.5 103.5 103.9 103.1
 Zähler: 35 5 0 0 0 0 0 0 0 0
 Innenzehner: 32
 weiteste: 431 (35), 411 (3), 304 (16)
 beste Teiler 36.8 (8.) 45.3 (27.) 60.8 (40.)
 Trefferlage 0.37 mm links, 0.35 mm tief
 Streuwert 1.25, horizontal: 1.44, vertikal: 1.02

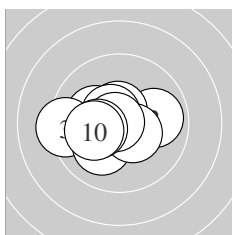
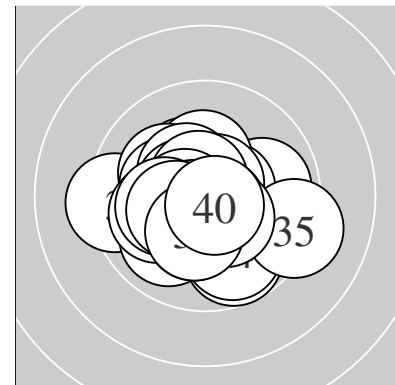

Serie 1:
 10.2 * 9.9 → 9.3 ← 10.6 * 10.6 *
 10.1 ↙ 10.5 * 10.8 * 10.3 * 10.2 *
 beste Teiler 36.8 (8.) 94.0 (4.) 96.1 (5.)
 Trefferlage 0.84 mm links, 0.10 mm tief
 Streuwert 1.40, horizontal: 1.81, vertikal: 0.80

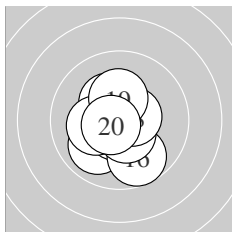

Serie 2:
 10.6 * 10.0 ↙ 10.3 * 10.6 * 10.2 *
 9.7 ↘ 10.5 * 10.6 * 10.3 * 10.7 *
 beste Teiler 75.6 (20.) 76.0 (11.) 86.0 (14.)
 Trefferlage 0.18 mm links, 0.39 mm tief
 Streuwert 1.21, horizontal: 1.07, vertikal: 1.33

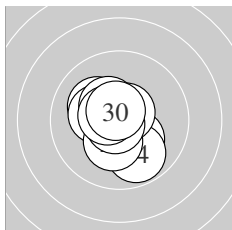

Serie 3:
 10.2 * 10.2 * 10.3 * 9.8 ↘ 10.3 *
 10.7 * 10.8 * 10.4 * 10.6 * 10.6 *
 beste Teiler 45.3 (27.) 72.0 (26.) 77.0 (30.)
 Trefferlage 0.34 mm links, 0.16 mm tief
 Streuwert 1.15, horizontal: 1.03, vertikal: 1.25

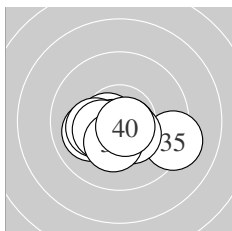

Serie 4:
 10.7 * 10.6 * 10.6 * 10.0 ← 9.2 →
 10.2 * 10.4 * 10.4 * 10.3 * 10.7 *
 beste Teiler 60.8 (40.) 72.1 (31.) 78.8 (33.)
 Trefferlage 0.13 mm links, 0.76 mm tief
 Streuwert 1.30, horizontal: 1.78, vertikal: 0.47

Unterschrift des Schützen

Meyton Elektronik

Ergebnis: **419.9** (398)
 Serien: 104.8 105.6 105.5 104.0
 Zähler: 38 2 0 0 0 0 0 0 0 0
 Innenzehner: 35
 weiteste: 310 (5), 252 (16), 248 (35)
 beste Teiler 17.0 (23.) 23.0 (6.) 37.3 (31.)
 Trefferlage 0.13 mm rechts, 0.24 mm tief
 Streuwert 0.93, horizontal: 1.13, vertikal: 0.68

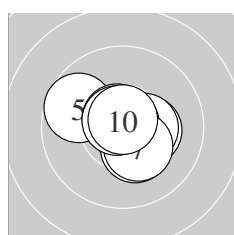
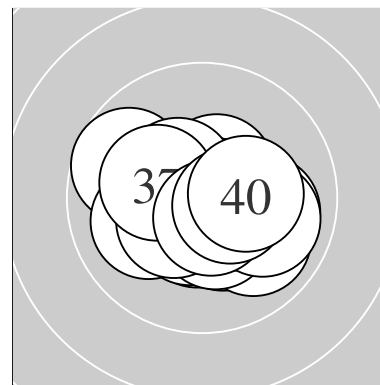

Serie 1:
 10.7 * 10.3 * 10.3 * 10.4 * 9.7 ↖
 10.9 * 10.3 * 10.7 * 10.7 * 10.8 *
 beste Teiler 23.0 (6.) 49.0 (10.) 57.3 (9.)
 Trefferlage 0.17 mm rechts, 0.03 mm tief
 Streuwert 1.06, horizontal: 1.26, vertikal: 0.81

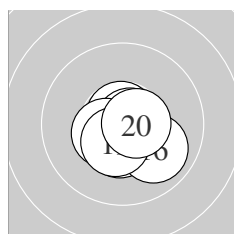

Serie 2:
 10.8 * 10.7 * 10.5 * 10.6 * 10.7 *
 9.9 ↘ 10.8 * 10.5 * 10.5 * 10.6 *
 beste Teiler 38.6 (11.) 48.8 (17.) 53.1 (12.)
 Trefferlage 0.08 mm rechts, 0.48 mm tief
 Streuwert 0.79, horizontal: 0.88, vertikal: 0.68

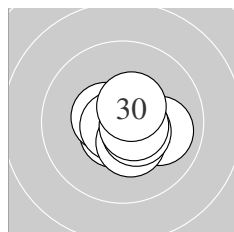

Serie 3:
 10.0 → 10.6 * 10.9 * 10.8 * 10.5 *
 10.7 * 10.4 * 10.5 * 10.6 * 10.5 *
 beste Teiler 17.0 (23.) 43.0 (24.) 58.1 (26.)
 Trefferlage 0.25 mm rechts, 0.26 mm tief
 Streuwert 0.82, horizontal: 0.98, vertikal: 0.62

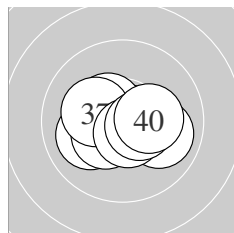

Serie 4:
 10.8 * 10.8 * 10.0 ↙ 10.4 * 10.0 →
 10.4 * 10.2 * 10.6 * 10.5 * 10.3 *
 beste Teiler 37.3 (31.) 41.1 (32.) 84.5 (38.)
 Trefferlage 0.03 mm rechts, 0.21 mm tief
 Streuwert 1.13, horizontal: 1.47, vertikal: 0.63

Unterschrift des Schützen

Meyton Elektronik

Ergebnis: **418.0** (396)
 Serien: 105.2 104.5 105.4 102.9
 Zähler: 36 4 0 0 0 0 0 0 0 0
 Innenzehner: 36
 weiteste: 361 (36), 333 (38), 283 (13)
 beste Teiler 37.6 (9.) 45.6 (24.) 46.4 (15.)
 Trefferlage 0.12 mm links, 0.12 mm tief
 Streuwert 1.03, horizontal: 1.05, vertikal: 1.02

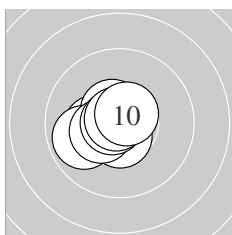
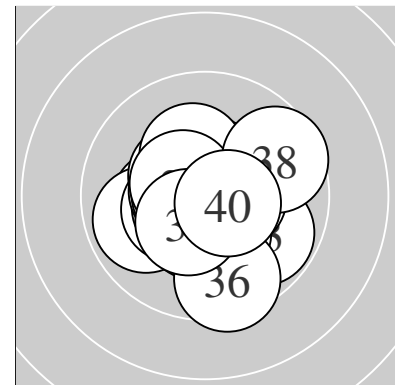

Serie 1:
 10.6 * 10.3 * 10.6 * 10.7 * 10.6 *
 9.9 ← 10.4 * 10.7 * 10.8 * 10.6 *
 beste Teiler 37.6 (9.) 53.0 (8.) 67.0 (4.)
 Trefferlage 0.71 mm links, 0.05 mm tief
 Streuwert 0.79, horizontal: 0.91, vertikal: 0.66

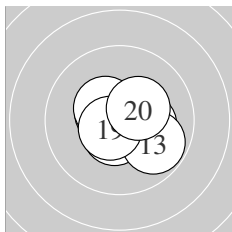

Serie 2:
 10.5 * 10.2 * 9.8 ↘ 10.6 * 10.8 *
 10.5 * 10.8 * 10.4 * 10.6 * 10.3 *
 beste Teiler 46.4 (15.) 46.4 (17.) 78.1 (14.)
 Trefferlage 0.12 mm rechts, 0.03 mm tief
 Streuwert 1.03, horizontal: 1.22, vertikal: 0.79

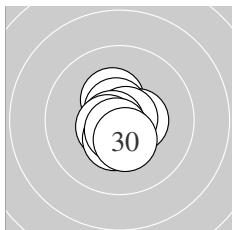

Serie 3:
 10.3 * 10.5 * 10.6 * 10.8 * 10.4 *
 10.7 * 10.6 * 10.4 * 10.7 * 10.4 *
 beste Teiler 45.6 (24.) 53.7 (26.) 72.7 (29.)
 Trefferlage 0.06 mm links, 0.29 mm tief
 Streuwert 0.78, horizontal: 0.60, vertikal: 0.92

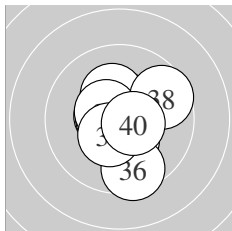

Serie 4:
 10.3 * 10.5 * 10.3 * 10.6 * 10.6 *
 9.5 ↓ 10.5 * 9.6 ↗ 10.4 * 10.6 *
 beste Teiler 86.3 (35.) 100.2 (34.) 100.8 (40.)
 Trefferlage 0.14 mm rechts, 0.12 mm tief
 Streuwert 1.43, horizontal: 1.25, vertikal: 1.59

Unterschrift des Schützen

Meyton Elektronik

Ergebnis: **408.2** (390)
 Serien: 103.0 100.7 101.1 103.4
 Zähler: 31 8 1 0 0 0 0 0 0
 Innenzehner: 24
 weiteste: 562 (38), 417 (17), 310 (2)
 beste Teiler 20.2 (10.) 52.1 (1.) 60.8 (34.)
 Trefferlage 0.33 mm links, 0.30 mm hoch
 Streuwert 1.51, horizontal: 1.94, vertikal: 0.89

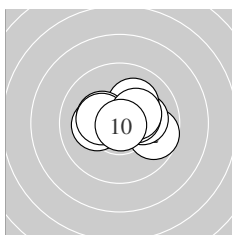
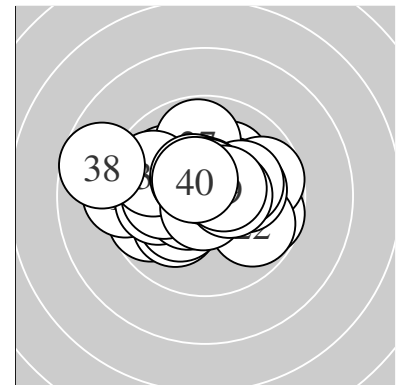

Serie 1:
 10.7 * 9.7 → 10.1 → 10.2 * 10.1 ↗
 10.3 * 10.4 * 10.3 * 10.3 * 10.9 *
 beste Teiler 20.2 (10.) 52.1 (1.) 144.3 (7.)
 Trefferlage 0.45 mm rechts, 0.30 mm hoch
 Streuwert 1.27, horizontal: 1.66, vertikal: 0.69

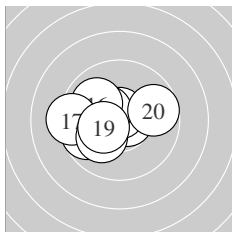

Serie 2:
 10.7 * 9.7 ← 10.7 * 9.8 ← 10.4 *
 10.0 ↘ 9.3 ← 10.1 ↗ 10.3 * 9.7 →
 beste Teiler 61.0 (13.) 66.1 (11.) 142.0 (15.)
 Trefferlage 1.24 mm links, 0.06 mm hoch
 Streuwert 1.59, horizontal: 2.04, vertikal: 0.93

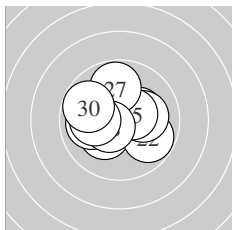

Serie 3:
 10.2 * 9.8 ↘ 10.3 * 10.1 → 10.5 *
 10.0 ← 9.8 ↑ 10.5 * 10.1 ← 9.8 ↖
 beste Teiler 105.6 (28.) 119.8 (25.) 172.8 (23.)
 Trefferlage 0.26 mm links, 0.19 mm hoch
 Streuwert 1.63, horizontal: 1.94, vertikal: 1.23

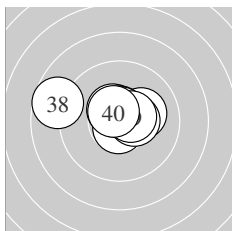

Serie 4:
 10.5 * 10.5 * 10.2 * 10.7 * 10.6 *
 10.4 * 10.7 * 8.7 ← 10.5 * 10.6 *
 beste Teiler 60.8 (34.) 75.1 (37.) 82.0 (35.)
 Trefferlage 0.29 mm links, 0.64 mm hoch
 Streuwert 1.46, horizontal: 1.98, vertikal: 0.59

Unterschrift des Schützen

Meyton Elektronik

Ergebnis: **408.1** (391)
 Serien: 104.2 100.8 101.8 101.3
 Zähler: 32 7 1 0 0 0 0 0 0 0
 Innenzehner: 22
 weiteste: 501 (16), 391 (5), 304 (26)
 beste Teiler 33.6 (40.) 46.0 (9.) 51.6 (21.)
 Trefferlage 0.41 mm rechts, 0.17 mm tief
 Streuwert 1.48, horizontal: 1.76, vertikal: 1.13

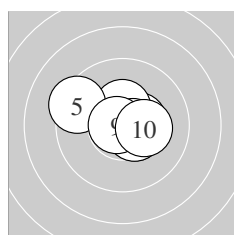
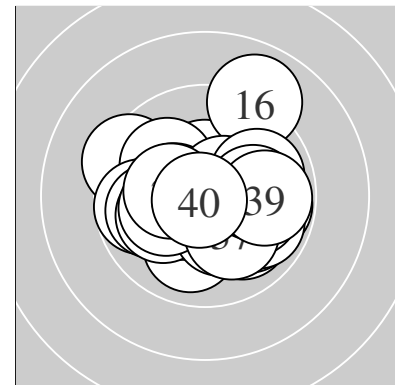

Serie 1:
 10.5 * 10.7 * 10.5 * 10.4 * 9.4 ↖
 10.5 * 10.6 * 10.5 * 10.8 * 10.3 *
 beste Teiler 46.0 (9.) 65.9 (2.) 83.3 (7.)
 Trefferlage 0.34 mm rechts, 0.17 mm hoch
 Streuwert 1.19, horizontal: 1.51, vertikal: 0.75

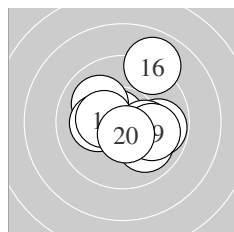

Serie 2:
 10.7 * 9.8 → 10.0 ↘ 10.2 * 10.4 *
 8.9 ↗ 10.2 * 10.0 ↘ 10.0 → 10.6 *
 beste Teiler 54.9 (11.) 99.4 (20.) 147.9 (15.)
 Trefferlage 0.55 mm rechts, 0.19 mm hoch
 Streuwert 1.79, horizontal: 1.86, vertikal: 1.71

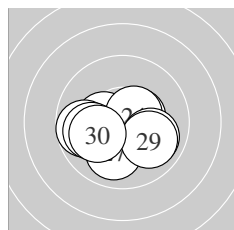

Serie 3:
 10.7 * 10.4 * 10.5 * 10.5 * 10.0 ↘
 9.7 ← 10.0 ↓ 9.9 ← 10.0 ↘ 10.1 ←
 beste Teiler 51.6 (21.) 105.9 (24.) 122.0 (23.)
 Trefferlage 0.29 mm links, 0.61 mm tief
 Streuwert 1.48, horizontal: 1.89, vertikal: 0.88

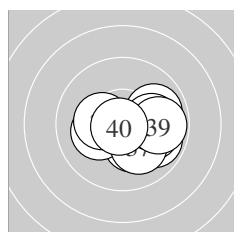

Serie 4:
 10.3 * 9.9 → 10.2 * 9.9 ↘ 10.3 *
 10.0 → 10.1 ↘ 10.0 → 9.8 → 10.8 *
 beste Teiler 33.6 (40.) 162.6 (35.) 169.5 (31.)
 Trefferlage 1.04 mm rechts, 0.46 mm tief
 Streuwert 1.36, horizontal: 1.74, vertikal: 0.83

Unterschrift des Schützen

Ergebnis: **417.6** (397)
 Serien: 103.3 103.4 105.9 105.0
 Zähler: 37 3 0 0 0 0 0 0 0 0
 Innenzehner: 36
 weiteste: 263 (14), 254 (10), 251 (13)
 beste Teiler 9.8 (25.) 22.2 (28.) 34.9 (34.)
 Trefferlage 0.09 mm rechts, 0.31 mm hoch
 Streuwert 1.00, horizontal: 1.17, vertikal: 0.79

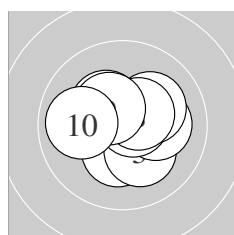
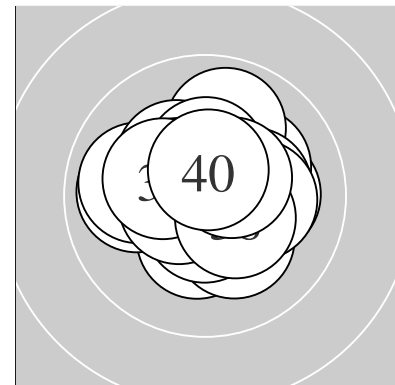

Serie 1:
 10.7 * 10.3 * 10.2 * 10.3 * 10.1 →
 10.7 * 10.2 * 10.5 * 10.4 * 9.9 ←
 beste Teiler 70.3 (6.) 73.3 (1.) 120.4 (8.)
 Trefferlage 0.10 mm rechts, 0.14 mm hoch
 Streuwert 1.23, horizontal: 1.43, vertikal: 1.00

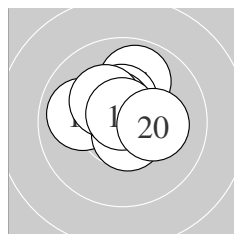

Serie 2:
 10.2 * 10.7 * 9.9 ← 9.9 ↑ 10.4 *
 10.6 * 10.5 * 10.3 * 10.7 * 10.2 *
 beste Teiler 51.1 (19.) 75.1 (12.) 84.3 (16.)
 Trefferlage 0.20 mm links, 0.69 mm hoch
 Streuwert 1.11, horizontal: 1.27, vertikal: 0.92

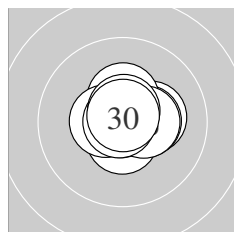

Serie 3:
 10.3 * 10.6 * 10.4 * 10.4 * 10.9 *
 10.4 * 10.5 * 10.9 * 10.7 * 10.8 *
 beste Teiler 9.8 (25.) 22.2 (28.) 41.1 (30.)
 Trefferlage 0.31 mm rechts, 0.20 mm hoch
 Streuwert 0.75, horizontal: 0.87, vertikal: 0.61

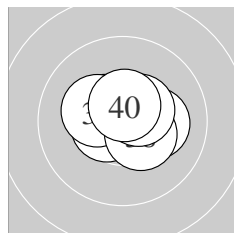

Serie 4:
 10.4 * 10.2 * 10.5 * 10.8 * 10.8 *
 10.5 * 10.3 * 10.4 * 10.5 * 10.6 *
 beste Teiler 34.9 (34.) 37.6 (35.) 97.7 (40.)
 Trefferlage 0.16 mm rechts, 0.22 mm hoch
 Streuwert 0.91, horizontal: 1.16, vertikal: 0.54

Unterschrift des Schützen

Meyton Elektronik

Ergebnis: **414.2** (395)
 Serien: 102.6 105.1 102.0 104.5
 Zähler: 36 3 1 0 0 0 0 0 0
 Innenzehner: 34
 weiteste: 540 (26), 393 (24), 365 (3)
 beste Teiler 7.8 (23.) 31.0 (10.) 35.5 (16.)
 Trefferlage 0.25 mm rechts, 0.62 mm hoch
 Streuwert 1.21, horizontal: 1.46, vertikal: 0.89

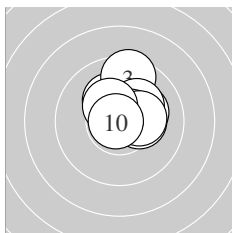
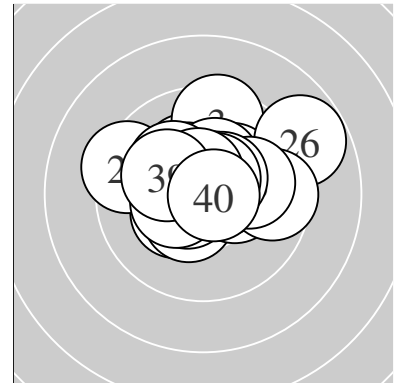

Serie 1:
 10.1 ↑ 10.2 * 9.5 ↑ 10.2 * 10.2 *
 10.3 * 10.6 * 10.3 * 10.4 * 10.8 *
 beste Teiler 31.0 (10.) 97.8 (7.) 147.3 (9.)
 Trefferlage 0.68 mm rechts, 1.09 mm hoch
 Streuwert 1.05, horizontal: 0.98, vertikal: 1.11

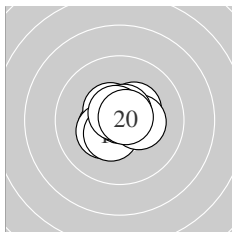

Serie 2:
 10.4 * 10.4 * 10.5 * 10.3 * 10.4 *
 10.8 * 10.3 * 10.6 * 10.7 * 10.7 *
 beste Teiler 35.5 (16.) 55.9 (20.) 66.7 (19.)
 Trefferlage 0.06 mm links, 0.08 mm hoch
 Streuwert 0.85, horizontal: 0.96, vertikal: 0.72

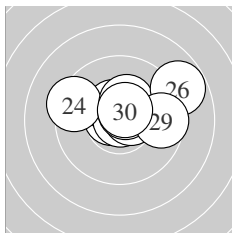

Serie 3:
 10.7 * 10.5 * 10.9 * 9.4 ↖ 10.3 *
 8.8 ↗ 10.6 * 10.6 * 9.6 → 10.6 *
 beste Teiler 7.8 (23.) 68.4 (21.) 81.6 (28.)
 Trefferlage 0.57 mm rechts, 0.82 mm hoch
 Streuwert 1.71, horizontal: 2.28, vertikal: 0.81

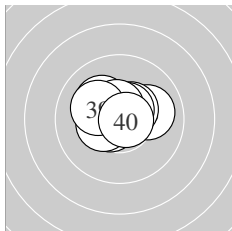

Serie 4:
 10.6 * 10.7 * 10.0 → 10.5 * 10.2 *
 10.6 * 10.4 * 10.6 * 10.2 * 10.7 *
 beste Teiler 52.4 (40.) 64.3 (32.) 87.3 (31.)
 Trefferlage 0.16 mm links, 0.49 mm hoch
 Streuwert 0.98, horizontal: 1.25, vertikal: 0.60

Unterschrift des Schützen

Meyton Elektronik

Ergebnis: **420.9** (400)
 Serien: 105.1 106.0 104.9 104.9
 Zähler: 40 0 0 0 0 0 0 0 0 0
 Innenzehner: 39
 weiteste: 201 (25), 198 (32), 194 (33)
 beste Teiler 18.0 (29.) 18.3 (28.) 21.2 (19.)
 Trefferlage 0.09 mm links, 0.04 mm hoch
 Streuwert 0.86, horizontal: 0.93, vertikal: 0.79

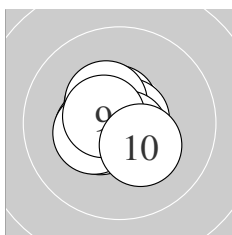
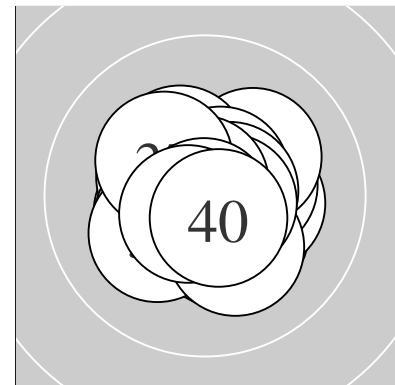

Serie 1:
 10.5 * 10.6 * 10.7 * 10.4 * 10.7 *
 10.4 * 10.5 * 10.4 * 10.6 * 10.3 *
 beste Teiler 51.0 (3.) 62.4 (5.) 92.5 (2.)
 Trefferlage 0.43 mm links, 0.04 mm hoch
 Streuwert 0.82, horizontal: 0.85, vertikal: 0.78

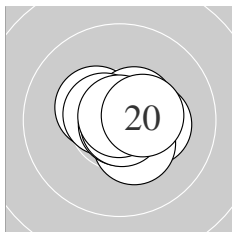

Serie 2:
 10.4 * 10.3 * 10.8 * 10.5 * 10.4 *
 10.6 * 10.9 * 10.8 * 10.9 * 10.4 *
 beste Teiler 21.2 (19.) 24.0 (17.) 30.8 (18.)
 Trefferlage 0.21 mm rechts, 0.02 mm hoch
 Streuwert 0.77, horizontal: 0.93, vertikal: 0.57

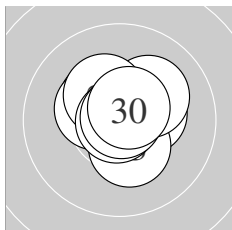

Serie 3:
 10.4 * 10.4 * 10.4 * 10.5 * 10.1 ↗
 10.4 * 10.3 * 10.9 * 10.9 * 10.6 *
 beste Teiler 18.0 (29.) 18.3 (28.) 83.6 (30.)
 Trefferlage 0.03 mm rechts, 0.50 mm hoch
 Streuwert 0.91, horizontal: 0.98, vertikal: 0.82

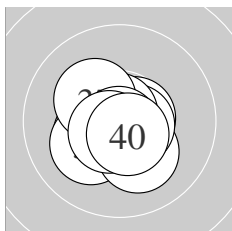

Serie 4:
 10.3 * 10.2 * 10.2 * 10.6 * 10.6 *
 10.8 * 10.2 * 10.8 * 10.6 * 10.6 *
 beste Teiler 36.2 (38.) 41.2 (36.) 78.1 (35.)
 Trefferlage 0.20 mm links, 0.37 mm tief
 Streuwert 0.89, horizontal: 0.97, vertikal: 0.81

Unterschrift des Schützen

Ergebnis: **413.1** (393)
 Serien: 103.7 103.2 103.5 102.7
 Zähler: 33 7 0 0 0 0 0 0 0 0
 Innenzehner: 30
 weiteste: 383 (31), 327 (24), 306 (17)
 beste Teiler 10.4 (2.) 19.1 (5.) 60.8 (25.)
 Trefferlage 0.26 mm rechts, 0.22 mm tief
 Streuwert 1.26, horizontal: 1.27, vertikal: 1.25

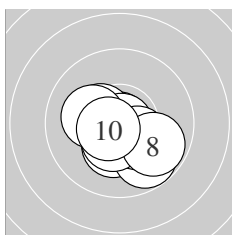
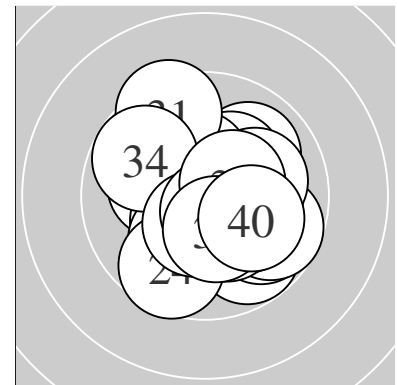

Serie 1:
 10.3 * 10.9 * 9.8 ↘ 10.4 * 10.9 *
 10.3 * 10.5 * 9.8 ↘ 10.2 * 10.6 *
 beste Teiler 10.4 (2.) 19.1 (5.) 89.4 (10.)
 Trefferlage 0.05 mm rechts, 0.72 mm tief
 Streuwert 1.18, horizontal: 1.37, vertikal: 0.95

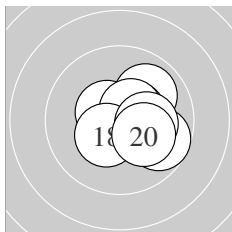

Serie 2:
 10.6 * 9.9 ↗ 10.7 * 10.5 * 10.5 *
 10.5 * 9.7 ↘ 10.4 * 10.2 * 10.2 *
 beste Teiler 71.5 (13.) 100.6 (11.) 104.2 (16.)
 Trefferlage 0.83 mm rechts, 0.00 mm
 Streuwert 1.14, horizontal: 1.29, vertikal: 0.95

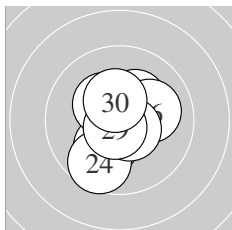

Serie 3:
 10.3 * 10.1 ↙ 10.7 * 9.6 ↙ 10.7 *
 10.1 → 10.3 * 10.6 * 10.7 * 10.4 *
 beste Teiler 60.8 (25.) 61.0 (29.) 62.1 (23.)
 Trefferlage 0.00 mm , 0.04 mm tief
 Streuwert 1.28, horizontal: 1.09, vertikal: 1.44

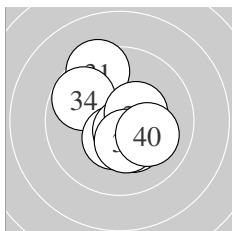

Serie 4:
 9.4 ↖ 10.5 * 10.3 * 9.8 ↘ 10.6 *
 10.5 * 10.7 * 10.4 * 10.4 * 10.1 ↘
 beste Teiler 74.2 (37.) 90.2 (35.) 106.5 (32.)
 Trefferlage 0.17 mm rechts, 0.13 mm tief
 Streuwert 1.46, horizontal: 1.33, vertikal: 1.58

Unterschrift des Schützen

Ergebnis: **415.2** (396)
 Serien: 103.7 102.9 103.6 105.0
 Zähler: 36 4 0 0 0 0 0 0 0 0
 Innenzehner: 32
 weiteste: 464 (17), 315 (27), 302 (6)
 beste Teiler 6.4 (14.) 22.3 (22.) 24.5 (28.)
 Trefferlage 0.04 mm rechts, 0.27 mm hoch
 Streuwert 1.20, horizontal: 1.31, vertikal: 1.07

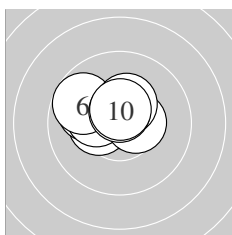
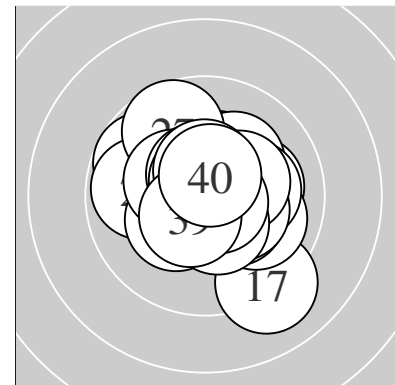

Serie 1:
 10.8 * 10.3 * 10.0 ↖ 10.6 * 10.2 *
 9.7 ↖ 10.5 * 10.4 * 10.6 * 10.6 *
 beste Teiler 39.1 (1.) 85.0 (9.) 96.2 (4.)
 Trefferlage 0.58 mm links, 0.72 mm hoch
 Streuwert 1.01, horizontal: 1.33, vertikal: 0.51

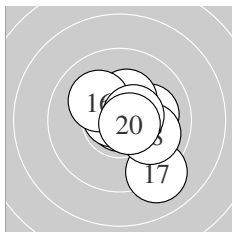

Serie 2:
 10.6 * 10.1 → 10.3 * 10.9 * 10.7 *
 10.1 ↖ 9.1 ↘ 10.0 ↘ 10.5 * 10.6 *
 beste Teiler 6.4 (14.) 53.8 (15.) 76.5 (20.)
 Trefferlage 0.78 mm rechts, 0.04 mm tief
 Streuwert 1.40, horizontal: 1.29, vertikal: 1.50

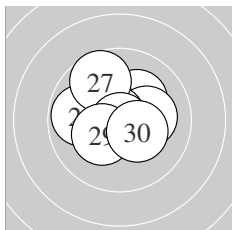

Serie 3:
 10.2 * 10.9 * 10.2 * 10.5 * 10.8 *
 9.8 ← 9.7 ↖ 10.9 * 10.3 * 10.3 *
 beste Teiler 22.3 (22.) 24.5 (28.) 48.0 (25.)
 Trefferlage 0.19 mm links, 0.23 mm hoch
 Streuwert 1.32, horizontal: 1.45, vertikal: 1.16

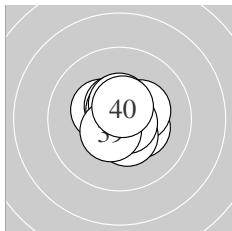

Serie 4:
 10.4 * 10.3 * 10.6 * 10.7 * 10.3 *
 10.5 * 10.4 * 10.7 * 10.5 * 10.6 *
 beste Teiler 59.0 (38.) 70.5 (34.) 92.6 (40.)
 Trefferlage 0.16 mm rechts, 0.19 mm hoch
 Streuwert 0.87, horizontal: 0.89, vertikal: 0.85

Unterschrift des Schützen

Meyton Elektronik

Ergebnis: **418.1** (399)
 Serien: 103.3 103.7 104.8 106.3
 Zähler: 39 1 0 0 0 0 0 0 0 0
 Innenzehner: 35
 weiteste: 366 (7), 217 (24), 212 (3)
 beste Teiler 14.4 (36.) 24.7 (32.) 38.0 (4.)
 Trefferlage 0.00 mm , 0.17 mm hoch
 Streuwert 1.01, horizontal: 1.14, vertikal: 0.86

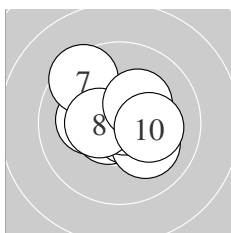
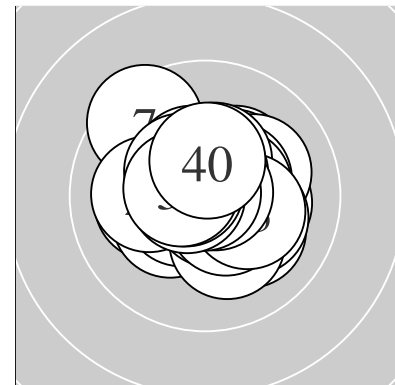

Serie 1:
 10.6 * 10.7 * 10.1 ↘ 10.8 * 10.2 *
 10.5 * 9.5 ↙ 10.4 * 10.3 * 10.2 *
 beste Teiler 38.0 (4.) 61.8 (2.) 83.7 (1.)
 Trefferlage 0.14 mm links, 0.28 mm hoch
 Streuwert 1.32, horizontal: 1.48, vertikal: 1.13

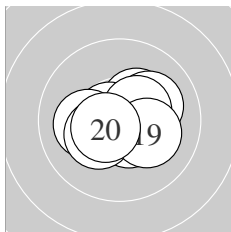

Serie 2:
 10.3 * 10.1 ↗ 10.6 * 10.7 * 10.1 ←
 10.5 * 10.4 * 10.3 * 10.2 * 10.5 *
 beste Teiler 68.3 (14.) 87.7 (13.) 102.8 (20.)
 Trefferlage 0.08 mm rechts, 0.10 mm tief
 Streuwert 1.11, horizontal: 1.37, vertikal: 0.77

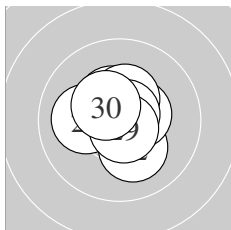

Serie 3:
 10.4 * 10.2 * 10.7 * 10.1 ← 10.7 *
 10.5 * 10.4 * 10.7 * 10.7 * 10.4 *
 beste Teiler 52.3 (28.) 52.8 (25.) 58.5 (29.)
 Trefferlage 0.03 mm links, 0.32 mm hoch
 Streuwert 0.93, horizontal: 0.95, vertikal: 0.92

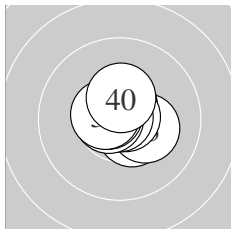

Serie 4:
 10.5 * 10.9 * 10.3 * 10.6 * 10.8 *
 10.9 * 10.7 * 10.6 * 10.6 * 10.4 *
 beste Teiler 14.4 (36.) 24.7 (32.) 41.4 (35.)
 Trefferlage 0.07 mm rechts, 0.19 mm hoch
 Streuwert 0.70, horizontal: 0.77, vertikal: 0.63

Unterschrift des Schützen

Meyton Elektronik

Ergebnis: **416.1** (397)
 Serien: 105.8 105.4 102.1 102.8
 Zähler: 37 3 0 0 0 0 0 0 0 0
 Innenzehner: 31
 weiteste: 343 (24), 325 (32), 253 (17)
 beste Teiler 7.0 (4.) 19.1 (9.) 27.1 (12.)
 Trefferlage 0.50 mm rechts, 0.03 mm tief
 Streuwert 1.09, horizontal: 1.16, vertikal: 1.01

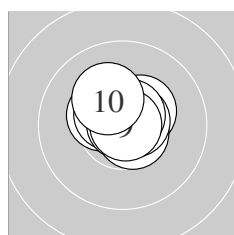
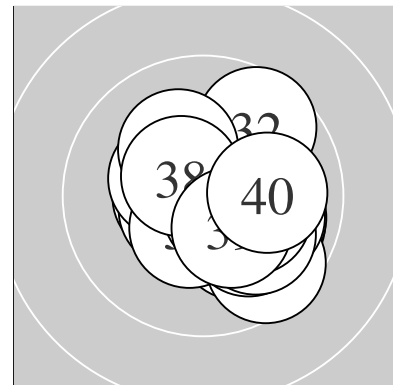

Serie 1:
 10.4 * 10.5 * 10.5 * 10.9 * 10.4 *
 10.6 * 10.7 * 10.7 * 10.9 * 10.2 *
 beste Teiler 7.0 (4.) 19.1 (9.) 74.3 (8.)
 Trefferlage 0.10 mm rechts, 0.50 mm hoch
 Streuwert 0.72, horizontal: 0.83, vertikal: 0.58

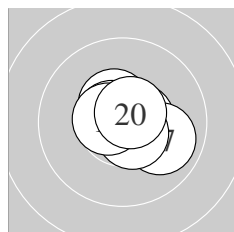

Serie 2:
 10.5 * 10.8 * 10.6 * 10.7 * 10.4 *
 10.7 * 9.9 ↘ 10.6 * 10.6 * 10.6 *
 beste Teiler 27.1 (12.) 67.1 (14.) 75.5 (16.)
 Trefferlage 0.41 mm rechts, 0.00 mm
 Streuwert 0.83, horizontal: 0.98, vertikal: 0.65

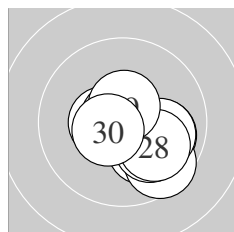

Serie 3:
 10.0 ↘ 10.1 ↘ 10.5 * 9.6 ↘ 10.8 *
 10.0 ↘ 10.0 ↘ 10.0 ↘ 10.6 * 10.5 *
 beste Teiler 43.8 (25.) 98.4 (29.) 103.3 (30.)
 Trefferlage 0.96 mm rechts, 0.79 mm tief
 Streuwert 1.23, horizontal: 1.41, vertikal: 1.03

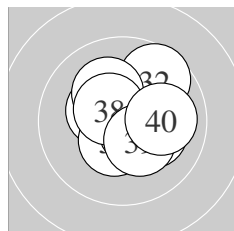

Serie 4:
 10.5 * 9.7 ↗ 10.4 * 10.2 * 10.4 *
 10.6 * 10.2 * 10.5 * 10.3 * 10.0 →
 beste Teiler 91.6 (36.) 110.4 (38.) 118.4 (31.)
 Trefferlage 0.53 mm rechts, 0.14 mm hoch
 Streuwert 1.31, horizontal: 1.34, vertikal: 1.27

Unterschrift des Schützen

Ergebnis: **412.3** (396)
 Serien: 103.0 102.9 102.9 103.5
 Zähler: 36 4 0 0 0 0 0 0 0 0
 Innenzehner: 28
 weiteste: 342 (16), 281 (10), 261 (27)
 beste Teiler 48.0 (6.) 58.2 (22.) 59.6 (35.)
 Trefferlage 0.41 mm links, 0.00 mm
 Streuwert 1.23, horizontal: 1.33, vertikal: 1.12

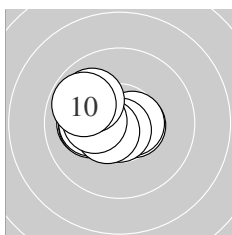
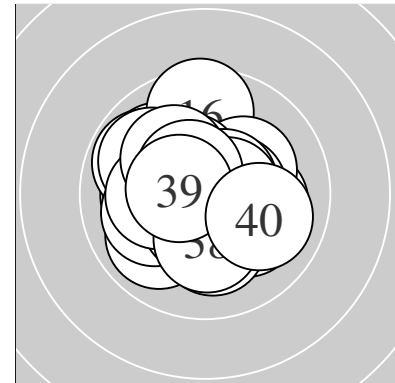

Serie 1:
 10.6 * 10.1 ← 10.1 ← 10.6 * 10.2 *
 10.8 * 10.5 * 10.3 * 10.0 ↘ 9.8 ↘
 beste Teiler 48.0 (6.) 88.0 (4.) 98.3 (1.)
 Trefferlage 1.13 mm links, 0.15 mm hoch
 Streuwert 1.05, horizontal: 1.30, vertikal: 0.72

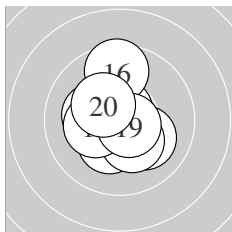

Serie 2:
 10.1 ↘ 10.4 * 10.3 * 10.7 * 10.2 *
 9.6 ↑ 10.3 * 10.3 * 10.7 * 10.3 *
 beste Teiler 65.3 (14.) 74.3 (19.) 146.7 (12.)
 Trefferlage 0.28 mm links, 0.19 mm hoch
 Streuwert 1.34, horizontal: 1.14, vertikal: 1.52

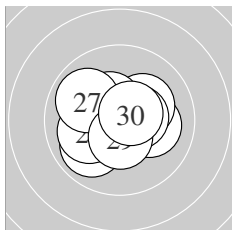

Serie 3:
 10.1 → 10.7 * 10.2 * 9.9 ↙ 10.1 ←
 10.4 * 9.9 ↘ 10.5 * 10.5 * 10.6 *
 beste Teiler 58.2 (22.) 91.0 (30.) 118.1 (29.)
 Trefferlage 0.06 mm links, 0.02 mm hoch
 Streuwert 1.34, horizontal: 1.59, vertikal: 1.03

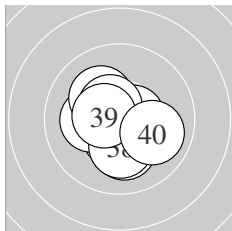

Serie 4:
 10.6 * 10.5 * 10.2 * 10.2 * 10.7 *
 10.1 ↓ 10.5 * 10.2 * 10.5 * 10.0 ↘
 beste Teiler 59.6 (35.) 90.9 (31.) 107.6 (37.)
 Trefferlage 0.19 mm links, 0.39 mm tief
 Streuwert 1.16, horizontal: 1.20, vertikal: 1.13

Unterschrift des Schützen

Meyton Elektronik

Ergebnis: **423.4** (399)
 Serien: 105.2 105.6 106.5 106.1
 Zähler: 39 1 0 0 0 0 0 0 0 0
 Innenzehner: 38
 weiteste: 273 (35), 214 (2), 175 (7)
 beste Teiler 6.0 (29.) 7.2 (36.) 10.2 (25.)
 Trefferlage 0.07 mm rechts, 0.01 mm tief
 Streuwert 0.78, horizontal: 0.95, vertikal: 0.58

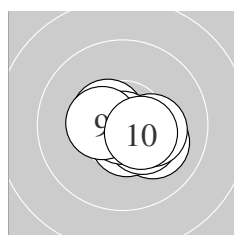
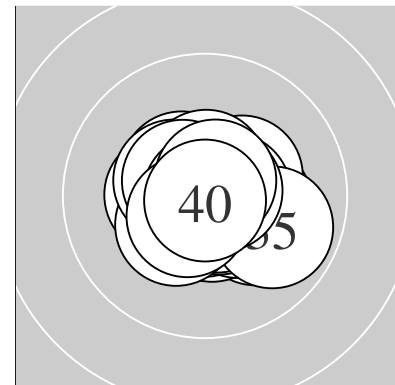

Serie 1:
 10.8 * 10.1 ↘ 10.6 * 10.6 * 10.5 *
 10.4 * 10.3 * 10.9 * 10.5 * 10.5 *
 beste Teiler 16.0 (8.) 42.2 (1.) 87.0 (3.)
 Trefferlage 0.28 mm rechts, 0.28 mm tief
 Streuwert 0.89, horizontal: 1.15, vertikal: 0.53

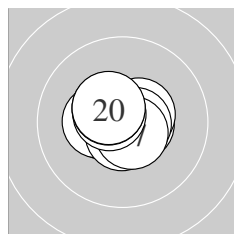

Serie 2:
 10.5 * 10.6 * 10.4 * 10.5 * 10.7 *
 10.7 * 10.6 * 10.6 * 10.5 * 10.5 *
 beste Teiler 74.1 (16.) 75.8 (15.) 85.1 (17.)
 Trefferlage 0.20 mm links, 0.10 mm hoch
 Streuwert 0.78, horizontal: 0.94, vertikal: 0.56

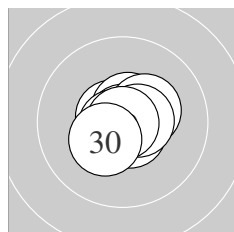

Serie 3:
 10.8 * 10.7 * 10.7 * 10.6 * 10.9 *
 10.3 * 10.6 * 10.7 * 10.9 * 10.3 *
 beste Teiler 6.0 (29.) 10.2 (25.) 45.8 (21.)
 Trefferlage 0.13 mm rechts, 0.02 mm hoch
 Streuwert 0.65, horizontal: 0.73, vertikal: 0.56

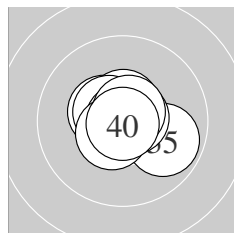

Serie 4:
 10.4 * 10.6 * 10.8 * 10.6 * 9.9 ↘
 10.9 * 10.7 * 10.6 * 10.7 * 10.9 *
 beste Teiler 7.2 (36.) 17.0 (40.) 32.9 (33.)
 Trefferlage 0.09 mm rechts, 0.11 mm hoch
 Streuwert 0.84, horizontal: 1.00, vertikal: 0.65

Unterschrift des Schützen

Meyton Elektronik

Ergebnis: **404.2** (386)
 Serien: 101.4 99.7 102.8 100.3
 Zähler: 28 11 0 1 0 0 0 0 0 0
 Innenzehner: 22
 weiteste: 827 (12), 368 (38), 343 (3)
 beste Teiler 29.0 (29.) 57.7 (10.) 67.6 (14.)
 Trefferlage 0.95 mm rechts, 0.58 mm hoch
 Streuwert 1.58, horizontal: 1.93, vertikal: 1.13

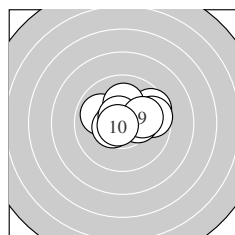
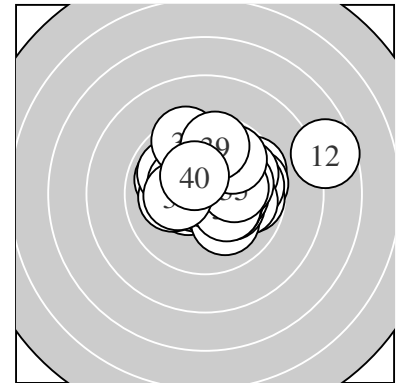

Serie 1:
 10.1 → 9.9 ← 9.6 → 10.1 ↑ 9.6 →
 10.3 * 10.5 * 10.6 * 10.0 → 10.7 *
 beste Teiler 57.7 (10.) 83.0 (8.) 118.4 (7.)
 Trefferlage 0.77 mm rechts, 0.68 mm hoch
 Streuwert 1.45, horizontal: 1.90, vertikal: 0.76

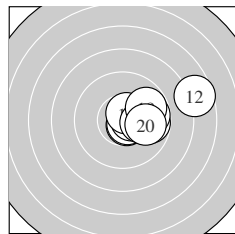

Serie 2:
 9.8 → 7.6 → 10.7 * 10.7 * 10.6 *
 9.8 → 10.6 * 10.2 * 9.8 → 9.9 →
 beste Teiler 67.6 (14.) 69.5 (13.) 85.9 (17.)
 Trefferlage 2.30 mm rechts, 0.32 mm hoch
 Streuwert 1.72, horizontal: 2.21, vertikal: 1.02

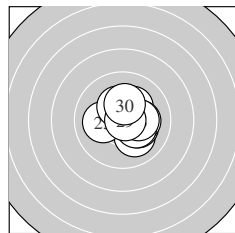

Serie 3:
 10.1 ↘ 10.2 * 10.1 ← 10.2 * 10.3 *
 10.2 * 10.3 * 10.3 * 10.8 * 10.3 *
 beste Teiler 29.0 (29.) 156.3 (25.) 166.4 (27.)
 Trefferlage 0.70 mm rechts, 0.10 mm hoch
 Streuwert 1.20, horizontal: 1.27, vertikal: 1.13

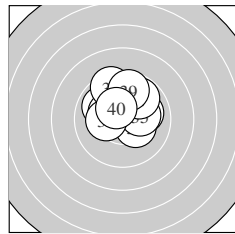

Serie 4:
 9.9 ↖ 10.0 → 10.3 * 10.3 * 10.2 *
 10.2 * 9.8 ↗ 9.5 ↘ 9.7 ↑ 10.4 *
 beste Teiler 137.5 (40.) 164.6 (34.) 167.7 (33.)
 Trefferlage 0.05 mm rechts, 1.22 mm hoch
 Streuwert 1.56, horizontal: 1.72, vertikal: 1.38

Unterschrift des Schützen

Meyton Elektronik

Ergebnis: **397.9** (380)
 Serien: 98.8 99.4 99.5 100.2
 Zähler: 22 16 2 0 0 0 0 0 0 0
 Innenzehner: 15
 weiteste: 634 (7), 508 (28), 455 (35)
 beste Teiler 47.8 (40.) 53.1 (9.) 69.0 (32.)
 Trefferlage 0.69 mm links, 0.10 mm hoch
 Streuwert 1.95, horizontal: 2.41, vertikal: 1.33

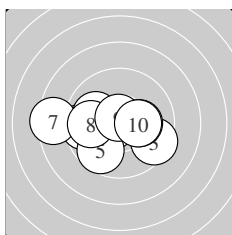
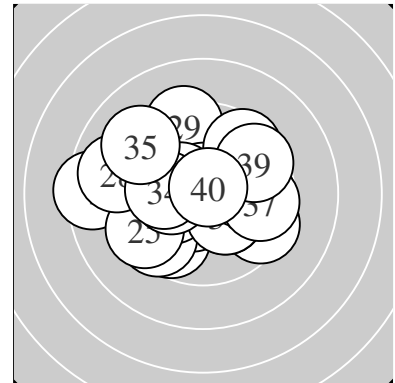

Serie 1:
 9.6 ← 10.6 * 9.5 ↘ 10.2 * 9.7 ↙
 10.0 ↖ 8.4 ← 9.9 ← 10.7 * 10.2 *
 beste Teiler 53.1 (9.) 89.6 (2.) 176.0 (10.)
 Trefferlage 1.05 mm links, 0.35 mm tief
 Streuwert 2.16, horizontal: 2.88, vertikal: 1.03

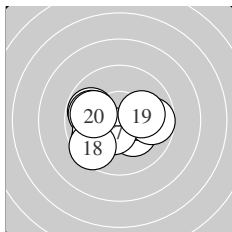

Serie 2:
 9.8 ↖ 10.2 * 9.8 ↙ 9.9 ← 9.7 →
 10.0 ← 10.5 * 9.5 ↙ 10.1 → 9.9 ←
 beste Teiler 121.8 (17.) 178.2 (12.) 217.3 (19.)
 Trefferlage 0.91 mm links, 0.49 mm tief
 Streuwert 1.78, horizontal: 2.24, vertikal: 1.15

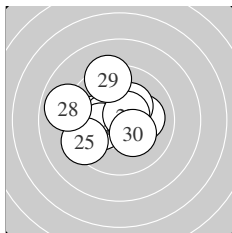

Serie 3:
 10.0 ← 10.1 → 10.5 * 10.2 * 9.4 ↙
 10.3 * 10.6 * 8.9 ← 9.3 ↑ 10.2 *
 beste Teiler 81.6 (27.) 123.2 (23.) 164.2 (26.)
 Trefferlage 0.99 mm links, 0.36 mm hoch
 Streuwert 1.95, horizontal: 2.24, vertikal: 1.62

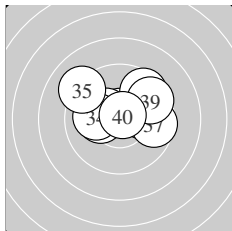

Serie 4:
 10.2 * 10.7 * 10.4 * 10.1 ← 9.1 ↖
 10.1 → 9.6 → 9.6 ↗ 9.6 ↗ 10.8 *
 beste Teiler 47.8 (40.) 69.0 (32.) 148.1 (33.)
 Trefferlage 0.19 mm rechts, 0.90 mm hoch
 Streuwert 1.87, horizontal: 2.39, vertikal: 1.12

Unterschrift des Schützen

Meyton Elektronik

Ergebnis: **414.8** (396)
 Serien: 104.6 101.8 104.5 103.9
 Zähler: 36 4 0 0 0 0 0 0 0 0
 Innenzehner: 30
 weiteste: 386 (11), 330 (14), 291 (4)
 beste Teiler 27.0 (1.) 29.7 (25.) 31.0 (3.)
 Trefferlage 0.31 mm links, 0.14 mm tief
 Streuwert 1.16, horizontal: 1.34, vertikal: 0.95

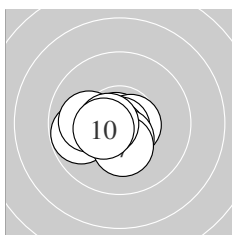
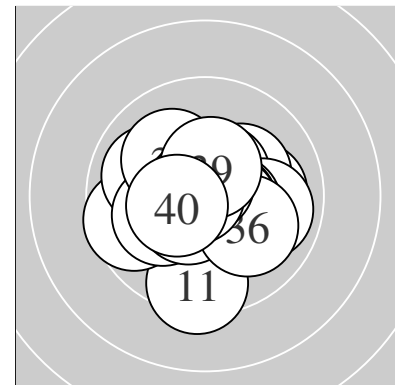

Serie 1:
 10.8 * 10.6 * 10.8 * 9.8 ← 10.7 *
 10.5 * 10.3 * 10.0 ← 10.6 * 10.5 *
 beste Teiler 27.0 (1.) 31.0 (3.) 68.7 (5.)
 Trefferlage 0.64 mm links, 0.49 mm tief
 Streuwert 0.91, horizontal: 1.16, vertikal: 0.57

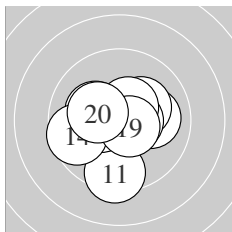

Serie 2:
 9.4 ↓ 10.2 * 10.4 * 9.6 ← 10.0 →
 10.2 * 10.6 * 10.5 * 10.6 * 10.3 *
 beste Teiler 85.4 (19.) 98.1 (17.) 112.6 (18.)
 Trefferlage 0.20 mm links, 0.23 mm tief
 Streuwert 1.58, horizontal: 1.72, vertikal: 1.42

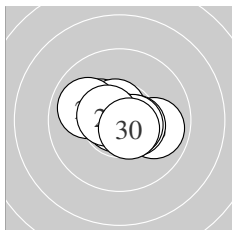

Serie 3:
 10.7 * 10.3 * 9.9 → 10.6 * 10.8 *
 10.0 ↖ 10.5 * 10.5 * 10.6 * 10.6 *
 beste Teiler 29.7 (25.) 58.6 (21.) 84.3 (24.)
 Trefferlage 0.05 mm links, 0.08 mm hoch
 Streuwert 1.08, horizontal: 1.41, vertikal: 0.59

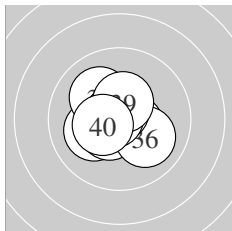

Serie 4:
 10.1 ← 10.5 * 10.4 * 10.5 * 10.1 ↗
 10.0 ↘ 10.7 * 10.8 * 10.4 * 10.4 *
 beste Teiler 49.4 (38.) 61.2 (37.) 107.5 (34.)
 Trefferlage 0.36 mm links, 0.07 mm hoch
 Streuwert 1.07, horizontal: 1.15, vertikal: 0.99

Unterschrift des Schützen

Meyton Elektronik

Ergebnis: **419.9** (400)
 Serien: 105.8 103.8 106.0 104.3
 Zähler: 40 0 0 0 0 0 0 0 0 0
 Innenzehner: 36
 weiteste: 234 (22), 233 (32), 224 (13)
 beste Teiler 44.9 (26.) 48.3 (28.) 49.6 (5.)
 Trefferlage 0.30 mm links, 0.13 mm tief
 Streuwert 0.87, horizontal: 1.03, vertikal: 0.68

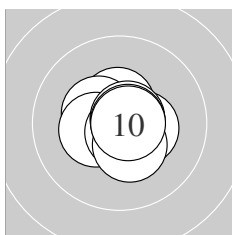
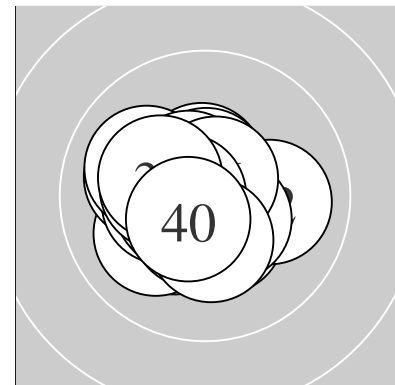

Serie 1:
 10.4 * 10.5 * 10.4 * 10.4 * 10.8 *
 10.7 * 10.4 * 10.7 * 10.8 * 10.7 *
 beste Teiler 49.6 (5.) 49.8 (9.) 51.0 (10.)
 Trefferlage 0.12 mm rechts, 0.06 mm tief
 Streuwert 0.76, horizontal: 0.85, vertikal: 0.66

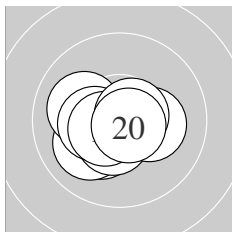

Serie 2:
 10.4 * 10.3 * 10.1 ↙ 10.1 ↘ 10.5 *
 10.2 * 10.4 * 10.5 * 10.6 * 10.7 *
 beste Teiler 62.7 (20.) 77.2 (19.) 101.3 (18.)
 Trefferlage 0.60 mm links, 0.40 mm tief
 Streuwert 1.00, horizontal: 1.25, vertikal: 0.67

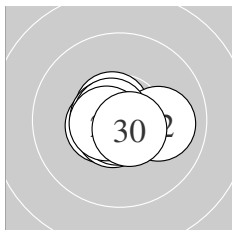

Serie 3:
 10.6 * 10.0 → 10.5 * 10.7 * 10.7 *
 10.8 * 10.7 * 10.8 * 10.6 * 10.6 *
 beste Teiler 44.9 (26.) 48.3 (28.) 58.1 (27.)
 Trefferlage 0.15 mm links, 0.15 mm tief
 Streuwert 0.75, horizontal: 0.98, vertikal: 0.40

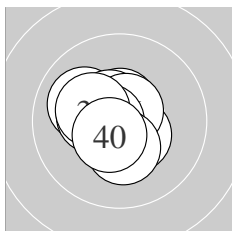

Serie 4:
 10.6 * 10.0 ↖ 10.3 * 10.5 * 10.5 *
 10.7 * 10.6 * 10.3 * 10.3 * 10.5 *
 beste Teiler 73.2 (36.) 76.0 (37.) 93.0 (31.)
 Trefferlage 0.57 mm links, 0.10 mm hoch
 Streuwert 0.94, horizontal: 0.97, vertikal: 0.90

Unterschrift des Schützen

Meyton Elektronik