

Ergebnis: **405.8** (388)
 Serien: 101.2 101.8 101.8 101.0
 Zaehler: 29 10 1 0 0 0 0 0 0 0
 Innenzehner: 24
 weiteste: 503 (36), 464 (6), 426 (28)
 beste Teiler 17.4 (22.) 20.8 (34.) 49.6 (1.)
 Trefferlage 0.90 mm rechts, 0.07 mm hoch
 Streuwert 1.53, horizontal: 1.88, vertikal: 1.07

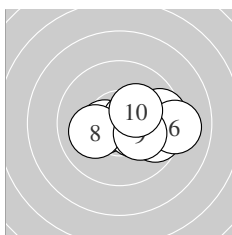

Serie 1:
 10.8 * 10.4 * 10.4 * 9.6 → 9.7 →
 9.1 → 10.6 * 10.1 ← 10.2 * 10.3 *
 beste Teiler 49.6 (1.) 79.1 (7.) 127.3 (2.)
 Trefferlage 1.32 mm rechts, 0.19 mm tief
 Streuwert 1.51, horizontal: 2.03, vertikal: 0.67

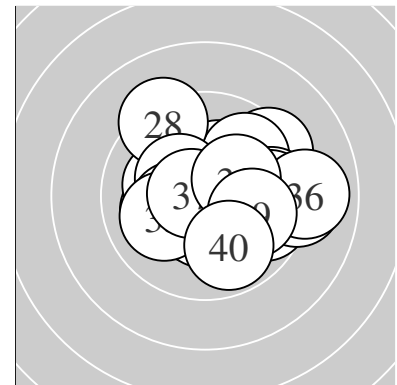
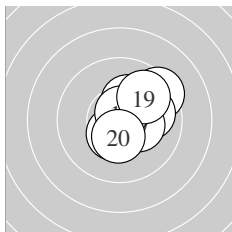

Serie 2:
 9.4 ↗ 10.4 * 10.3 * 10.4 * 10.1 →
 10.0 → 10.3 * 10.7 * 9.8 ↗ 10.4 *
 beste Teiler 65.0 (18.) 126.1 (14.) 128.8 (12.)
 Trefferlage 1.25 mm rechts, 0.50 mm hoch
 Streuwert 1.21, horizontal: 1.20, vertikal: 1.21

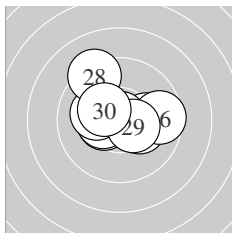

Serie 3:
 10.1 → 10.9 * 10.2 * 10.4 * 10.4 *
 9.6 → 10.2 * 9.2 ↘ 10.5 * 10.3 *
 beste Teiler 17.4 (22.) 125.0 (29.) 132.2 (24.)
 Trefferlage 0.04 mm rechts, 0.40 mm hoch
 Streuwert 1.62, horizontal: 1.93, vertikal: 1.25

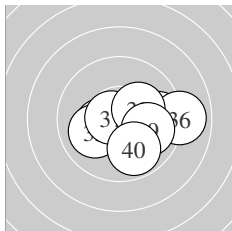

Serie 4:
 10.3 * 9.7 → 10.6 * 10.9 * 10.0 ←
 8.9 → 10.7 * 10.2 * 9.9 → 9.8 ↘
 beste Teiler 20.8 (34.) 69.0 (37.) 80.0 (33.)
 Trefferlage 0.98 mm rechts, 0.41 mm tief
 Streuwert 1.68, horizontal: 2.20, vertikal: 0.91

Unterschrift des Schuetzen

Meyton Elektronik

Ergebnis:	398.2	(382)
Serien:	101.1	102.2 97.0 97.9
Zaehler:	28 7 4 1 0 0 0 0 0 0	
Innenzehner:	21	
weiteste:	974 (22), 680 (33), 666 (39)	
beste Teiler	46.8 (38.) 59.3 (14.) 91.0 (16.)	
Trefferlage	1.29 mm rechts, 0.38 mm tief	
Streuwert	2.05, horizontal: 2.48, vertikal: 1.51	

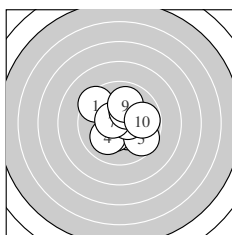
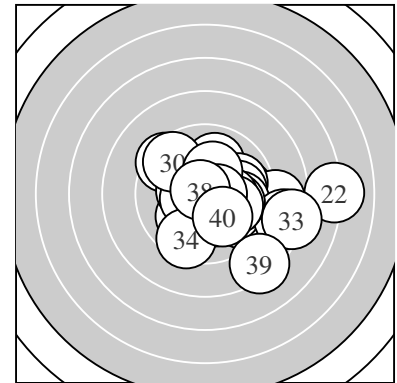

Serie 1:	9.4 ↘	10.4 *	10.4 *	10.1 ↙	9.6 ↘
	10.5 *	10.6 *	10.3 *	10.0 ↑	9.8 →
beste Teiler	95.4 (7.) 103.9 (6.) 144.4 (3.)				
Trefferlage	0.32 mm rechts, 0.12 mm hoch				
Streuwert	1.71, horizontal: 1.83, vertikal: 1.59				

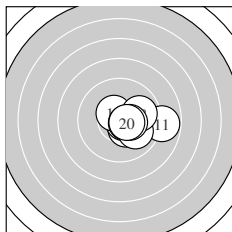

Serie 2:	8.8 →	10.4 *	10.3 *	10.7 *	10.5 *
	10.6 *	10.0 ↘	9.9 →	10.4 *	10.6 *
beste Teiler	59.3 (14.) 91.0 (16.) 95.5 (20.)				
Trefferlage	1.50 mm rechts, 0.29 mm tief				
Streuwert	1.23, horizontal: 1.59, vertikal: 0.71				

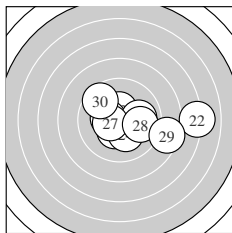

Serie 3:	10.4 *	7.1 →	10.4 *	10.2 *	10.4 *
	10.0 →	10.5 *	9.9 →	8.5 →	9.6 ↘
beste Teiler	121.1 (27.) 131.0 (23.) 145.8 (25.)				
Trefferlage	1.57 mm rechts, 0.15 mm tief				
Streuwert	2.83, horizontal: 3.77, vertikal: 1.34				

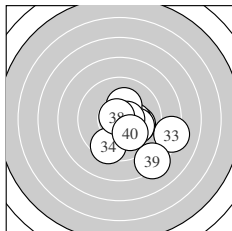

Serie 4:	10.0 →	10.2 *	8.2 →	9.5 ↙	10.0 →
	10.2 *	10.6 *	10.8 *	8.3 ↘	10.1 ↘
beste Teiler	46.8 (38.) 91.0 (37.) 176.3 (32.)				
Trefferlage	1.77 mm rechts, 1.19 mm tief				
Streuwert	2.12, horizontal: 2.25, vertikal: 1.98				

Unterschrift des Schuetzen

Meyton Elektronik

Ergebnis: **415.8** (398)
 Serien: 104.6 104.4 103.5 103.3
 Zaehler: 38 2 0 0 0 0 0 0 0 0
 Innenzehner: 32
 weiteste: 265 (24), 254 (28), 238 (30)
 beste Teiler 13.1 (20.) 43.1 (6.) 43.9 (15.)
 Trefferlage 0.26 mm links, 0.00 mm
 Streuwert 1.08, horizontal: 1.18, vertikal: 0.98

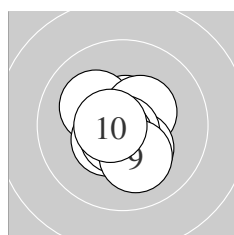
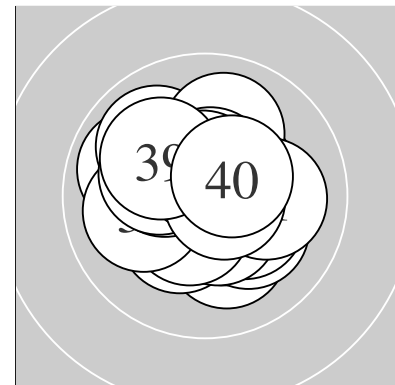

Serie 1:
 10.6 * 10.2 * 10.5 * 10.4 * 10.3 *
 10.8 * 10.4 * 10.6 * 10.1 ↓ 10.7 *
 beste Teiler 43.1 (6.) 75.1 (10.) 81.8 (8.)
 Trefferlage 0.00 mm , 0.34 mm tief
 Streuwert 0.96, horizontal: 0.90, vertikal: 1.01

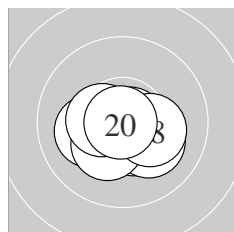

Serie 2:
 10.4 * 10.5 * 10.4 * 10.2 * 10.8 *
 10.1 ← 10.3 * 10.3 * 10.5 * 10.9 *
 beste Teiler 13.1 (20.) 43.9 (15.) 117.3 (12.)
 Trefferlage 0.18 mm links, 0.59 mm tief
 Streuwert 0.95, horizontal: 1.24, vertikal: 0.51

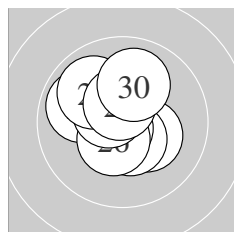

Serie 3:
 10.3 * 10.5 * 10.7 * 9.9 ↖ 10.7 *
 10.5 * 10.5 * 9.9 ↗ 10.5 * 10.0 ↑
 beste Teiler 53.0 (25.) 67.0 (23.) 107.6 (27.)
 Trefferlage 0.42 mm links, 0.35 mm hoch
 Streuwert 1.18, horizontal: 1.15, vertikal: 1.20

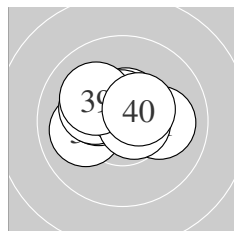

Serie 4:
 10.1 → 10.0 ← 10.3 * 10.5 * 10.3 *
 10.2 * 10.6 * 10.7 * 10.1 ↘ 10.5 *
 beste Teiler 71.7 (38.) 90.4 (37.) 103.7 (34.)
 Trefferlage 0.45 mm links, 0.57 mm hoch
 Streuwert 1.13, horizontal: 1.48, vertikal: 0.61

Unterschrift des Schuetzen

Ergebnis: **411.4** (394)
 Serien: 102.1 102.8 102.9 103.6
 Zaehler: 34 6 0 0 0 0 0 0 0 0
 Innenzehner: 25
 weiteste: 380 (21), 378 (13), 359 (5)
 beste Teiler 23.8 (6.) 37.9 (25.) 64.0 (37.)
 Trefferlage 0.13 mm rechts, 0.37 mm hoch
 Streuwert 1.32, horizontal: 1.31, vertikal: 1.34

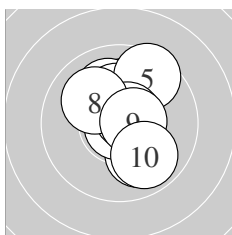
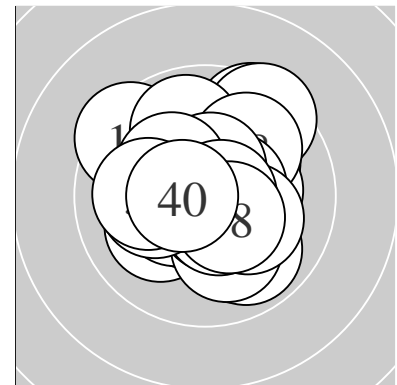

Serie 1:
 10.1 ↑ 10.0 ↘ 10.1 ↗ 10.2 * 9.5 ↗
 10.9 * 10.7 * 10.1 ↘ 10.6 * 9.9 ↘
 beste Teiler 23.8 (6.) 73.5 (7.) 92.7 (9.)
 Trefferlage 0.36 mm rechts, 0.67 mm hoch
 Streuwert 1.47, horizontal: 1.11, vertikal: 1.77

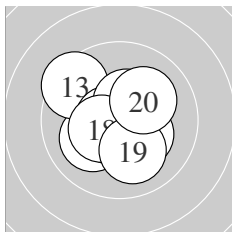

Serie 2:
 10.6 * 10.1 ↙ 9.4 ↘ 10.7 * 10.5 *
 10.6 * 10.3 * 10.4 * 10.1 ↘ 10.1 ↗
 beste Teiler 73.1 (14.) 85.0 (11.) 92.0 (16.)
 Trefferlage 0.30 mm links, 0.03 mm hoch
 Streuwert 1.40, horizontal: 1.45, vertikal: 1.35

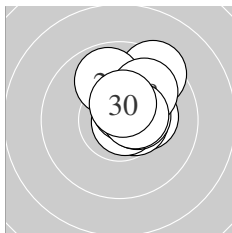

Serie 3:
 9.4 ↗ 10.3 * 10.5 * 9.9 ↑ 10.8 *
 10.5 * 10.6 * 9.9 ↗ 10.5 * 10.5 *
 beste Teiler 37.9 (25.) 91.6 (27.) 101.8 (23.)
 Trefferlage 0.90 mm rechts, 1.01 mm hoch
 Streuwert 1.02, horizontal: 0.87, vertikal: 1.15

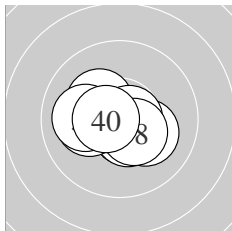

Serie 4:
 10.6 * 10.2 * 10.2 * 10.5 * 10.1 ←
 10.3 * 10.7 * 10.4 * 10.0 ← 10.6 *
 beste Teiler 64.0 (37.) 89.9 (31.) 92.0 (40.)
 Trefferlage 0.41 mm links, 0.23 mm tief
 Streuwert 1.11, horizontal: 1.43, vertikal: 0.66

Unterschrift des Schuetzen

Meyton Elektronik

Ergebnis: **418.8** (398)
 Serien: 104.2 104.6 105.3 104.7
 Zaehler: 38 2 0 0 0 0 0 0 0 0
 Innenzehner: 36
 weiteste: 279 (11), 276 (36), 238 (8)
 beste Teiler 27.8 (33.) 36.2 (15.) 36.2 (39.)
 Trefferlage 0.11 mm rechts, 0.06 mm tief
 Streuwert 0.96, horizontal: 1.09, vertikal: 0.82

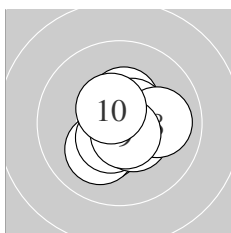
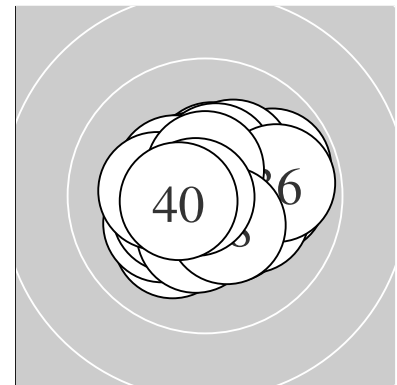

Serie 1:
 10.3 * 10.1 ↙ 10.7 * 10.4 * 10.6 *
 10.5 * 10.5 * 10.0 → 10.6 * 10.5 *
 beste Teiler 58.9 (3.) 76.1 (9.) 99.0 (5.)
 Trefferlage 0.16 mm rechts, 0.19 mm tief
 Streuwert 1.04, horizontal: 1.05, vertikal: 1.03

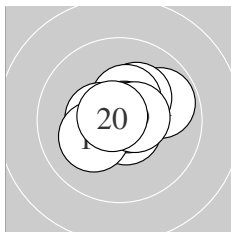

Serie 2:
 9.8 → 10.2 * 10.4 * 10.7 * 10.8 *
 10.5 * 10.7 * 10.2 * 10.6 * 10.7 *
 beste Teiler 36.2 (15.) 53.2 (20.) 53.7 (17.)
 Trefferlage 0.28 mm rechts, 0.31 mm hoch
 Streuwert 1.01, horizontal: 1.20, vertikal: 0.79

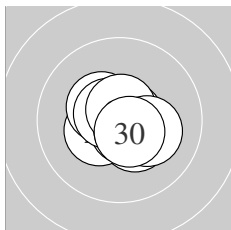

Serie 3:
 10.7 * 10.4 * 10.4 * 10.7 * 10.4 *
 10.6 * 10.6 * 10.7 * 10.2 * 10.6 *
 beste Teiler 56.3 (21.) 65.1 (24.) 67.6 (28.)
 Trefferlage 0.18 mm rechts, 0.21 mm tief
 Streuwert 0.83, horizontal: 0.96, vertikal: 0.68

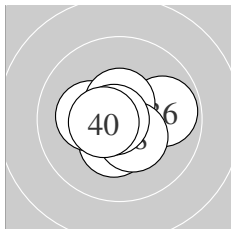

Serie 4:
 10.6 * 10.4 * 10.8 * 10.6 * 10.2 *
 9.8 → 10.6 * 10.4 * 10.8 * 10.5 *
 beste Teiler 27.8 (33.) 36.2 (39.) 84.0 (31.)
 Trefferlage 0.16 mm links, 0.14 mm tief
 Streuwert 1.01, horizontal: 1.23, vertikal: 0.73

Unterschrift des Schuetzen

Ergebnis: **397.5** (380)
 Serien: 97.0 102.0 97.3 101.2
 Zaehler: 25 11 3 1 0 0 0 0 0 0
 Innenzehner: 17
 weiteste: 814 (23), 561 (7), 530 (11)
 beste Teiler 29.9 (40.) 33.9 (14.) 83.0 (15.)
 Trefferlage 0.48 mm links, 0.47 mm hoch
 Streuwert 2.11, horizontal: 2.69, vertikal: 1.29

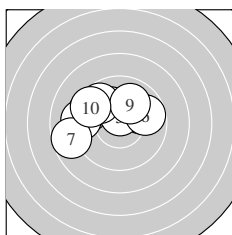
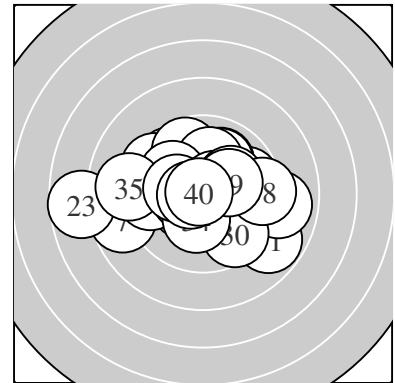

Serie 1:
 9.9 ↗ 9.5 ↖ 9.2 ← 10.1 ↘ 10.6 *
 9.8 ↗ 8.7 ← 9.7 ↘ 10.0 ↗ 9.5 ↖
 beste Teiler 84.2 (5.) 201.7 (4.) 246.0 (9.)
 Trefferlage 1.30 mm links, 1.07 mm hoch
 Streuwert 2.17, horizontal: 2.85, vertikal: 1.14

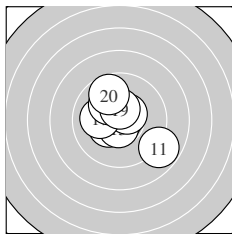

Serie 2:
 8.8 ↘ 10.5 * 10.4 * 10.8 * 10.6 *
 10.5 * 10.1 ← 10.1 ↘ 10.5 * 9.7 ↘
 beste Teiler 33.9 (14.) 83.0 (15.) 107.9 (16.)
 Trefferlage 0.13 mm links, 0.29 mm hoch
 Streuwert 1.72, horizontal: 1.82, vertikal: 1.61

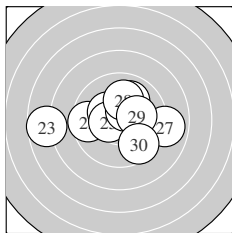

Serie 3:
 10.0 ↗ 9.5 ← 7.7 ← 10.3 * 10.5 *
 10.5 * 8.9 → 10.1 ↑ 10.2 * 9.6 ↘
 beste Teiler 120.9 (26.) 121.6 (25.) 160.8 (24.)
 Trefferlage 0.29 mm links, 0.22 mm hoch
 Streuwert 2.73, horizontal: 3.59, vertikal: 1.45

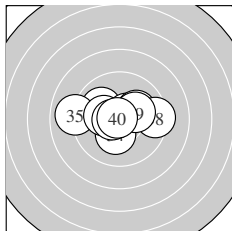

Serie 4:
 10.0 ↘ 10.6 * 10.1 ↗ 10.3 * 9.0 ←
 10.2 * 10.6 * 9.4 → 10.2 * 10.8 *
 beste Teiler 29.9 (40.) 83.2 (37.) 99.4 (32.)
 Trefferlage 0.19 mm links, 0.30 mm hoch
 Streuwert 1.84, horizontal: 2.47, vertikal: 0.81

Unterschrift des Schuetzen

Meyton Elektronik

Ergebnis: **411.2** (391)
 Serien: 102.6 100.8 104.3 103.5
 Zaehler: 31 9 0 0 0 0 0 0 0 0
 Innenzehner: 26
 weiteste: 386 (11), 358 (25), 327 (12)
 beste Teiler 5.3 (27.) 27.8 (23.) 33.8 (2.)
 Trefferlage 0.14 mm links, 0.14 mm tief
 Streuwert 1.39, horizontal: 1.54, vertikal: 1.21

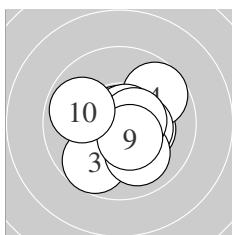
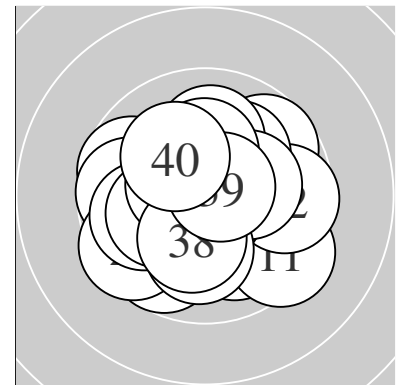

Serie 1:
 10.3 * 10.8 * 9.7 ↙ 9.7 ↗ 10.7 *
 10.4 * 10.0 ↘ 10.6 * 10.5 * 9.9 ↖
 beste Teiler 33.8 (2.) 58.0 (5.) 100.6 (8.)
 Trefferlage 0.43 mm rechts, 0.25 mm tief
 Streuwert 1.44, horizontal: 1.53, vertikal: 1.34

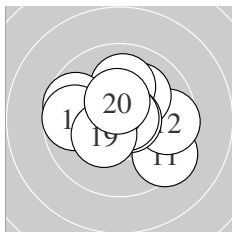

Serie 2:
 9.4 ↘ 9.6 → 10.1 ↗ 10.0 ↑ 9.7 ↖
 9.7 ← 10.7 * 10.8 * 10.4 * 10.4 *
 beste Teiler 47.4 (18.) 63.0 (17.) 130.1 (20.)
 Trefferlage 0.16 mm rechts, 0.32 mm hoch
 Streuwert 1.80, horizontal: 2.16, vertikal: 1.34

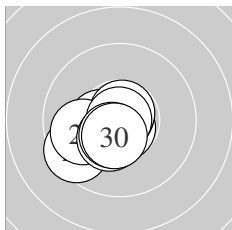

Serie 3:
 10.7 * 10.4 * 10.8 * 10.7 * 9.5 ↖
 9.9 ← 10.9 * 10.4 * 10.5 * 10.5 *
 beste Teiler 5.3 (27.) 27.8 (23.) 51.5 (24.)
 Trefferlage 0.79 mm links, 0.61 mm tief
 Streuwert 0.97, horizontal: 1.12, vertikal: 0.78

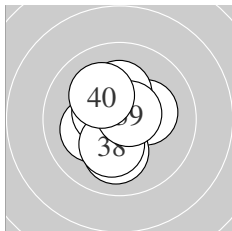

Serie 4:
 10.6 * 10.7 * 10.2 * 10.2 * 10.5 *
 10.2 * 10.1 ↓ 10.2 * 10.7 * 10.1 ↘
 beste Teiler 68.1 (32.) 73.9 (39.) 96.6 (31.)
 Trefferlage 0.40 mm links, 0.01 mm tief
 Streuwert 1.16, horizontal: 1.01, vertikal: 1.29

Unterschrift des Schuetzen

Meyton Elektronik

Ergebnis: **414.2** (395)
 Serien: 103.0 101.6 105.1 104.5
 Zaehler: 35 5 0 0 0 0 0 0 0 0
 Innenzehner: 30
 weiteste: 335 (3), 330 (16), 283 (8)
 beste Teiler 27.3 (30.) 48.0 (33.) 49.2 (35.)
 Trefferlage 0.13 mm links, 0.28 mm hoch
 Streuwert 1.18, horizontal: 1.21, vertikal: 1.15

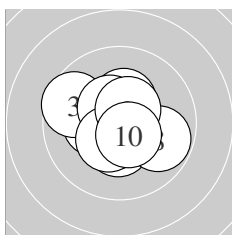
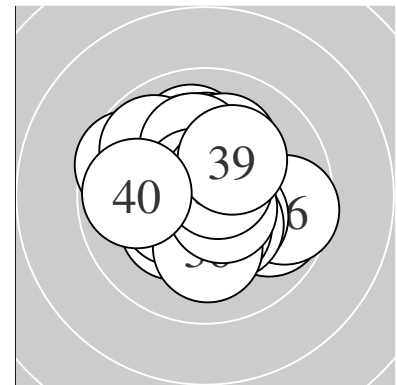

Serie 1:
 10.4 * 10.3 * 9.6 ↖ 10.3 * 10.5 *
 10.6 * 10.4 * 9.8 ↗ 10.5 * 10.6 *
 beste Teiler 100.6 (10.) 100.7 (6.) 109.9 (9.)
 Trefferlage 0.25 mm links, 0.05 mm tief
 Streuwert 1.34, horizontal: 1.51, vertikal: 1.14

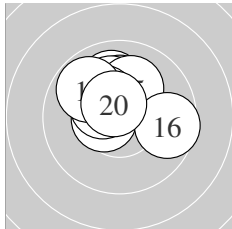

Serie 2:
 10.0 ↑ 10.2 * 10.5 * 10.1 ↑ 10.1 ↗
 9.6 → 10.3 * 10.4 * 9.8 ↖ 10.6 *
 beste Teiler 99.4 (20.) 106.7 (13.) 137.8 (18.)
 Trefferlage 0.29 mm links, 1.23 mm hoch
 Streuwert 1.25, horizontal: 1.46, vertikal: 0.98

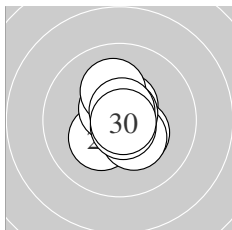

Serie 3:
 10.3 * 10.5 * 10.6 * 10.1 ↑ 10.4 *
 10.3 * 10.7 * 10.7 * 10.7 * 10.8 *
 beste Teiler 27.3 (30.) 51.4 (27.) 56.8 (28.)
 Trefferlage 0.12 mm rechts, 0.10 mm hoch
 Streuwert 0.90, horizontal: 0.72, vertikal: 1.04

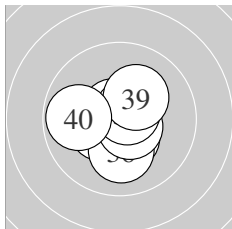

Serie 4:
 10.4 * 10.4 * 10.8 * 10.7 * 10.8 *
 10.1 ↓ 10.6 * 10.7 * 10.2 * 9.8 ←
 beste Teiler 48.0 (33.) 49.2 (35.) 65.6 (34.)
 Trefferlage 0.09 mm links, 0.15 mm tief
 Streuwert 1.09, horizontal: 1.15, vertikal: 1.02

Unterschrift des Schuetzen

Meyton Elektronik

Ergebnis: **411.9** (393)
 Serien: 102.6 101.0 105.0 103.3
 Zaehler: 33 7 0 0 0 0 0 0 0 0
 Innenzehner: 27
 weiteste: 438 (4), 395 (36), 343 (12)
 beste Teiler 13.6 (5.) 25.4 (23.) 46.5 (40.)
 Trefferlage 0.10 mm rechts, 0.28 mm hoch
 Streuwert 1.36, horizontal: 1.57, vertikal: 1.12

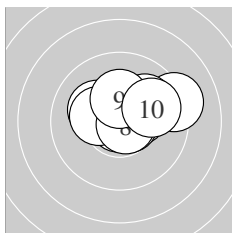
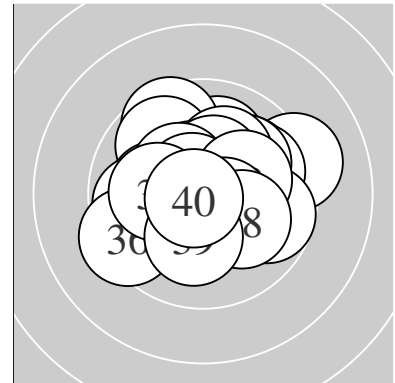

Serie 1:
 10.4 * 10.7 * 10.2 * 9.2 → 10.9 *
 10.0 ↗ 10.3 * 10.7 * 10.3 * 9.9 →
 beste Teiler 13.6 (5.) 51.8 (8.) 69.6 (2.)
 Trefferlage 0.76 mm rechts, 0.67 mm hoch
 Streuwert 1.36, horizontal: 1.79, vertikal: 0.71

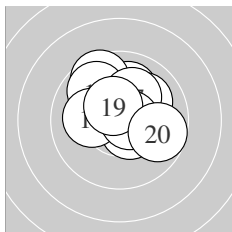

Serie 2:
 10.0 ↑ 9.6 ↖ 10.0 ↗ 9.8 ↖ 10.5 *
 10.1 ← 10.2 * 10.6 * 10.5 * 9.7 →
 beste Teiler 77.0 (18.) 107.5 (15.) 118.5 (19.)
 Trefferlage 0.20 mm rechts, 1.02 mm hoch
 Streuwert 1.49, horizontal: 1.62, vertikal: 1.35

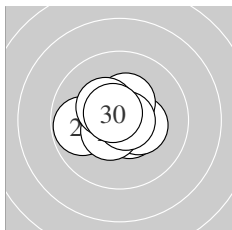

Serie 3:
 10.5 * 9.8 ← 10.9 * 10.4 * 10.6 *
 10.4 * 10.5 * 10.4 * 10.8 * 10.7 *
 beste Teiler 25.4 (23.) 47.2 (29.) 74.2 (30.)
 Trefferlage 0.25 mm links, 0.10 mm hoch
 Streuwert 0.99, horizontal: 1.20, vertikal: 0.72

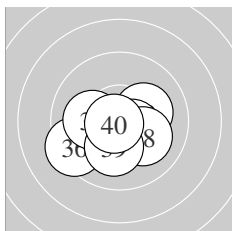

Serie 4:
 10.7 * 10.2 * 10.7 * 10.5 * 10.6 *
 9.4 ↙ 10.1 ← 10.1 ↘ 10.2 * 10.8 *
 beste Teiler 46.5 (40.) 62.0 (31.) 71.5 (33.)
 Trefferlage 0.28 mm links, 0.68 mm tief
 Streuwert 1.28, horizontal: 1.61, vertikal: 0.83

Unterschrift des Schuetzen

Meyton Elektronik

Ergebnis: **410.3** (391)
 Serien: 100.5 102.8 103.1 103.9
 Zaehler: 32 7 1 0 0 0 0 0 0 0
 Innenzehner: 25
 weiteste: 579 (4), 308 (20), 305 (23)
 beste Teiler 30.2 (13.) 38.5 (37.) 59.0 (3.)
 Trefferlage 0.57 mm links, 0.28 mm hoch
 Streuwert 1.37, horizontal: 1.62, vertikal: 1.05

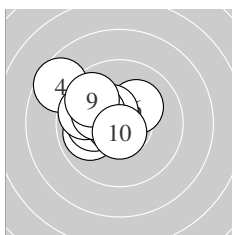
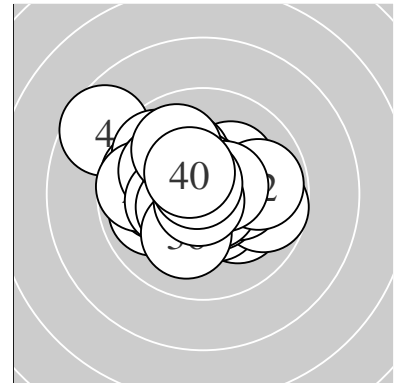

Serie 1:
 9.9 ← 10.1 ← 10.7 * 8.6 ↖ 9.8 ↖
 10.2 * 10.5 * 10.2 * 9.8 ↖ 10.7 *
 beste Teiler 59.0 (3.) 72.0 (10.) 118.6 (7.)
 Trefferlage 1.62 mm links, 0.74 mm hoch
 Streuwert 1.49, horizontal: 1.73, vertikal: 1.22

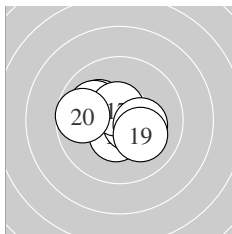

Serie 2:
 10.1 ↖ 10.1 ↖ 10.8 * 10.0 ↖ 10.5 *
 10.6 * 10.6 * 10.3 * 10.1 ↘ 9.7 ←
 beste Teiler 30.2 (13.) 92.1 (16.) 94.1 (17.)
 Trefferlage 0.49 mm links, 0.09 mm hoch
 Streuwert 1.33, horizontal: 1.65, vertikal: 0.90

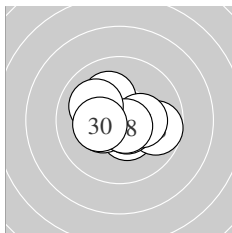

Serie 3:
 10.5 * 10.4 * 9.7 → 10.6 * 10.4 *
 10.2 * 10.3 * 10.7 * 10.0 ↖ 10.3 *
 beste Teiler 68.5 (28.) 82.1 (24.) 125.8 (21.)
 Trefferlage 0.00 mm , 0.04 mm hoch
 Streuwert 1.30, horizontal: 1.58, vertikal: 0.95

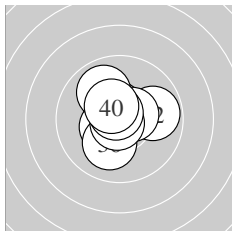

Serie 4:
 10.6 * 9.8 → 10.6 * 10.5 * 10.4 *
 10.1 ↓ 10.8 * 10.7 * 9.9 ↖ 10.5 *
 beste Teiler 38.5 (37.) 59.1 (38.) 78.1 (31.)
 Trefferlage 0.17 mm links, 0.26 mm hoch
 Streuwert 1.16, horizontal: 1.20, vertikal: 1.11

Unterschrift des Schuetzen

Ergebnis: **392.8** (377)
 Serien: 97.8 98.2 98.3 98.5
 Zaehler: 18 21 1 0 0 0 0 0 0 0
 Innenzehner: 10
 weiteste: 633 (7), 491 (3), 484 (33)
 beste Teiler 74.3 (12.) 94.2 (27.) 103.3 (8.)
 Trefferlage 0.42 mm links, 0.64 mm hoch
 Streuwert 2.14, horizontal: 2.76, vertikal: 1.22

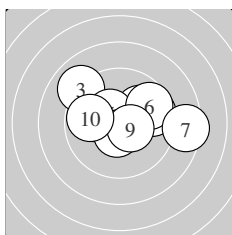
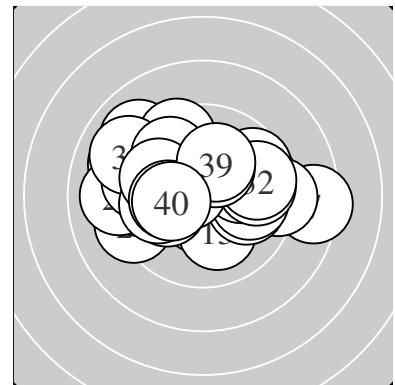

Serie 1:
 10.0 ↗ 10.0 ← 9.0 ↘ 9.6 → 10.4 *
 9.6 ↗ 8.4 → 10.5 * 10.5 * 9.8 ←
 beste Teiler 103.3 (8.) 114.0 (9.) 134.5 (5.)
 Trefferlage 0.51 mm rechts, 0.72 mm hoch
 Streuwert 2.37, horizontal: 3.12, vertikal: 1.24

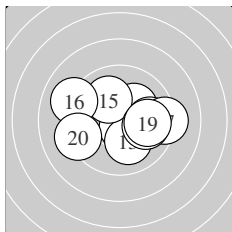

Serie 2:
 10.2 * 10.7 * 10.1 ↓ 9.8 → 10.1 ↘
 9.1 ↘ 9.2 → 9.9 → 9.9 → 9.2 ←
 beste Teiler 74.3 (12.) 186.0 (11.) 215.2 (13.)
 Trefferlage 0.54 mm rechts, 0.01 mm tief
 Streuwert 2.25, horizontal: 2.89, vertikal: 1.33

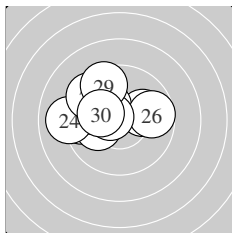

Serie 3:
 9.5 ← 10.1 ← 10.0 → 9.0 ← 10.2 *
 9.7 → 10.6 * 9.5 ↘ 9.5 ↘ 10.2 *
 beste Teiler 94.2 (27.) 177.7 (25.) 191.3 (30.)
 Trefferlage 1.34 mm links, 0.84 mm hoch
 Streuwert 1.90, horizontal: 2.42, vertikal: 1.19

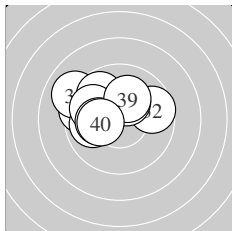

Serie 4:
 9.5 ↘ 9.7 → 9.0 ↘ 10.3 * 9.8 ↘
 9.9 ← 9.9 ↘ 10.1 ← 10.1 ↑ 10.2 *
 beste Teiler 175.0 (34.) 184.6 (40.) 201.2 (38.)
 Trefferlage 1.40 mm links, 0.99 mm hoch
 Streuwert 1.76, horizontal: 2.25, vertikal: 1.05

Unterschrift des Schuetzen

Meyton Elektronik

Ergebnis: **418.1** (399)
 Serien: 104.1 103.8 104.8 105.4
 Zaehler: 39 1 0 0 0 0 0 0 0 0
 Innenzehner: 34
 weiteste: 281 (37), 250 (2), 248 (33)
 beste Teiler 24.1 (34.) 30.8 (40.) 32.0 (17.)
 Trefferlage 0.19 mm rechts, 0.31 mm hoch
 Streuwert 0.98, horizontal: 1.05, vertikal: 0.91

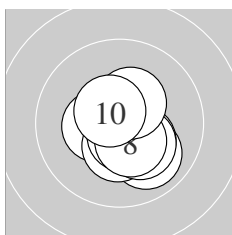
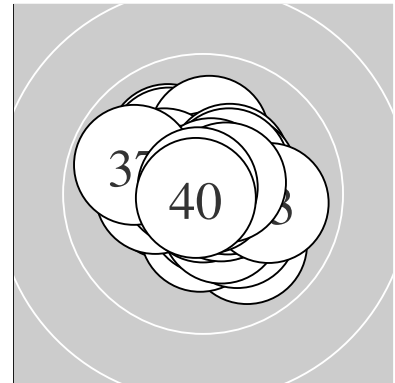

Serie 1:
 10.8 * 10.0 ↘ 10.4 * 10.4 * 10.3 *
 10.2 * 10.6 * 10.4 * 10.4 * 10.6 *
 beste Teiler 38.0 (1.) 79.8 (7.) 97.4 (10.)
 Trefferlage 0.40 mm rechts, 0.57 mm tief
 Streuwert 0.97, horizontal: 0.93, vertikal: 1.01

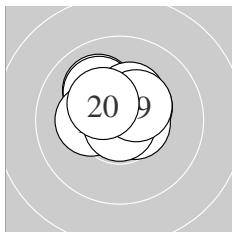

Serie 2:
 10.4 * 10.6 * 10.0 ↘ 10.6 * 10.1 ↘
 10.2 * 10.8 * 10.3 * 10.4 * 10.4 *
 beste Teiler 32.0 (17.) 94.3 (14.) 95.3 (12.)
 Trefferlage 0.08 mm links, 0.74 mm hoch
 Streuwert 0.98, horizontal: 1.15, vertikal: 0.79

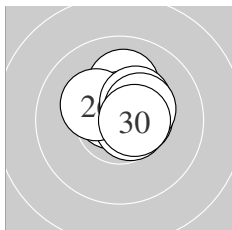

Serie 3:
 10.5 * 10.7 * 10.1 ↑ 10.6 * 10.7 *
 10.3 * 10.4 * 10.5 * 10.4 * 10.6 *
 beste Teiler 66.6 (22.) 73.5 (25.) 83.3 (24.)
 Trefferlage 0.32 mm rechts, 0.71 mm hoch
 Streuwert 0.78, horizontal: 0.85, vertikal: 0.71

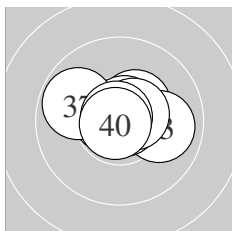

Serie 4:
 10.4 * 10.8 * 10.0 → 10.9 * 10.6 *
 10.7 * 9.8 ↙ 10.6 * 10.8 * 10.8 *
 beste Teiler 24.1 (34.) 30.8 (40.) 32.0 (39.)
 Trefferlage 0.11 mm rechts, 0.35 mm hoch
 Streuwert 0.97, horizontal: 1.30, vertikal: 0.45

Unterschrift des Schuetzen

Meyton Elektronik

Ergebnis: **403.4** (384)
 Serien: 100.3 100.9 101.6 100.6
 Zaehler: 24 16 0 0 0 0 0 0 0 0
 Innenzehner: 19
 weiteste: 403 (10), 402 (1), 402 (17)
 beste Teiler 22.8 (20.) 27.0 (3.) 48.7 (4.)
 Trefferlage 0.00 mm , 0.27 mm tief
 Streuwert 1.72, horizontal: 1.76, vertikal: 1.68

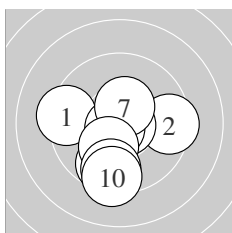
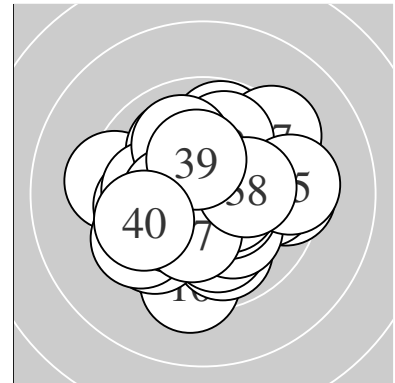

Serie 1:
 9.3 ← 9.5 → 10.8 * 10.8 * 10.7 *
 9.7 ↓ 10.4 * 10.2 * 9.6 ↓ 9.3 ↓
 beste Teiler 27.0 (3.) 48.7 (4.) 51.6 (5.)
 Trefferlage 0.26 mm links, 1.09 mm tief
 Streuwert 1.85, horizontal: 1.89, vertikal: 1.82

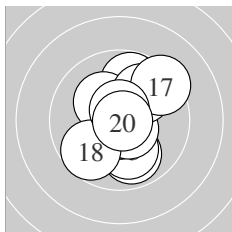

Serie 2:
 9.8 ↑ 9.9 ↓ 10.0 ↓ 10.6 * 10.2 *
 9.9 ↗ 9.3 ↗ 9.7 ↘ 10.6 * 10.9 *
 beste Teiler 22.8 (20.) 77.0 (19.) 94.0 (14.)
 Trefferlage 0.45 mm rechts, 0.18 mm hoch
 Streuwert 1.76, horizontal: 1.44, vertikal: 2.04

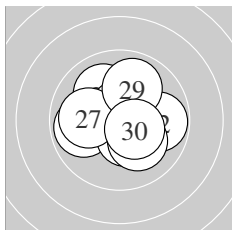

Serie 3:
 10.0 ↘ 9.8 → 9.9 ← 10.5 * 10.6 *
 10.4 * 10.0 ← 10.1 ↘ 9.9 ↑ 10.4 *
 beste Teiler 77.0 (25.) 116.0 (24.) 131.0 (30.)
 Trefferlage 0.13 mm rechts, 0.03 mm hoch
 Streuwert 1.53, horizontal: 1.73, vertikal: 1.31

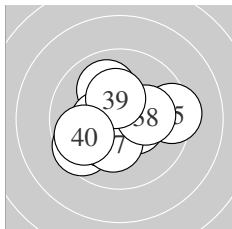

Serie 4:
 9.6 ↙ 10.0 ↘ 10.2 * 10.5 * 9.4 →
 10.4 * 10.2 * 10.2 * 10.3 * 9.8 ←
 beste Teiler 119.5 (34.) 143.5 (36.) 156.8 (39.)
 Trefferlage 0.29 mm links, 0.23 mm tief
 Streuwert 1.77, horizontal: 2.09, vertikal: 1.38

Unterschrift des Schuetzen

Meyton Elektronik

Ergebnis: **408.7** (390)
 Serien: 101.8 99.5 104.8 102.6
 Zaehler: 31 8 1 0 0 0 0 0 0 0
 Innenzehner: 24
 weiteste: 550 (18), 407 (14), 380 (31)
 beste Teiler 44.0 (26.) 57.0 (25.) 71.1 (38.)
 Trefferlage 0.73 mm links, 0.77 mm hoch
 Streuwert 1.32, horizontal: 1.58, vertikal: 0.98

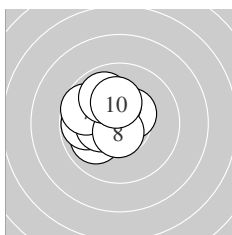
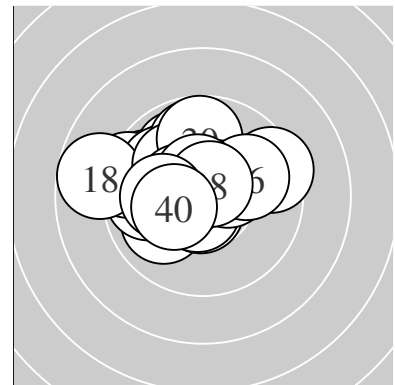

Serie 1:
 10.6 * 10.4 * 10.0 ↙ 9.8 ← 10.3 *
 10.3 * 9.7 ↖ 10.6 * 9.9 ↗ 10.2 *
 beste Teiler 76.9 (8.) 94.3 (1.) 127.7 (2.)
 Trefferlage 1.13 mm links, 0.46 mm hoch
 Streuwert 1.24, horizontal: 1.26, vertikal: 1.23

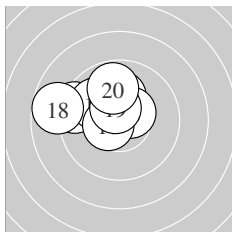

Serie 2:
 10.1 ↑ 10.0 ↘ 10.5 * 9.3 ← 10.1 ↘
 9.9 ↖ 10.5 * 8.8 ← 10.5 * 9.8 ↑
 beste Teiler 107.1 (17.) 112.8 (19.) 114.0 (13.)
 Trefferlage 1.58 mm links, 1.26 mm hoch
 Streuwert 1.47, horizontal: 1.90, vertikal: 0.84

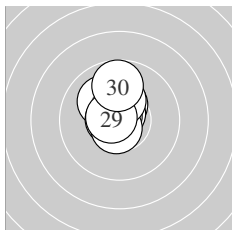

Serie 3:
 10.7 * 10.1 ↘ 10.6 * 10.4 * 10.7 *
 10.8 * 10.7 * 10.3 * 10.7 * 9.8 ↑
 beste Teiler 44.0 (26.) 57.0 (25.) 74.4 (27.)
 Trefferlage 0.37 mm links, 0.88 mm hoch
 Streuwert 0.82, horizontal: 0.49, vertikal: 1.05

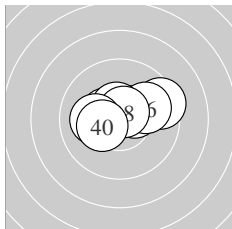

Serie 4:
 9.4 → 10.4 * 10.5 * 10.3 * 10.4 *
 10.0 → 10.5 * 10.7 * 10.1 ← 10.3 *
 beste Teiler 71.1 (38.) 101.3 (33.) 101.9 (37.)
 Trefferlage 0.14 mm rechts, 0.47 mm hoch
 Streuwert 1.38, horizontal: 1.86, vertikal: 0.61

Unterschrift des Schuetzen

Meyton Elektronik

Ergebnis: **409.3** (391)
 Serien: 104.0 101.1 101.8 102.4
 Zaehler: 31 9 0 0 0 0 0 0 0 0
 Innenzehner: 29
 weiteste: 473 (18), 374 (12), 343 (34)
 beste Teiler 43.8 (14.) 55.0 (9.) 71.1 (10.)
 Trefferlage 0.83 mm rechts, 0.26 mm tief
 Streuwert 1.34, horizontal: 1.52, vertikal: 1.13

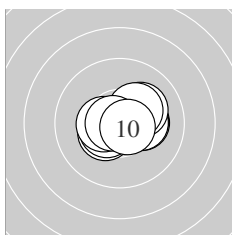
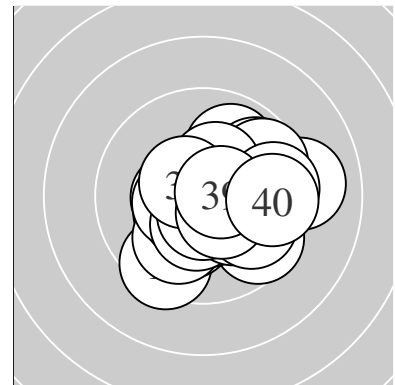

Serie 1:
 10.4 * 10.2 * 10.3 * 10.3 * 10.5 *
 10.2 * 10.4 * 10.3 * 10.7 * 10.7 *
 beste Teiler 55.0 (9.) 71.1 (10.) 116.7 (5.)
 Trefferlage 0.48 mm rechts, 0.05 mm hoch
 Streuwert 1.03, horizontal: 1.33, vertikal: 0.60

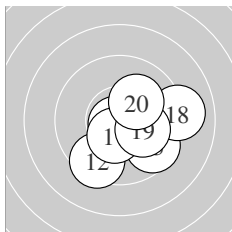

Serie 2:
 10.5 * 9.5 ↙ 10.5 * 10.8 * 9.6 ↘
 10.4 * 10.4 * 9.1 → 10.1 ↘ 10.2 *
 beste Teiler 43.8 (14.) 103.8 (13.) 107.6 (11.)
 Trefferlage 1.12 mm rechts, 0.59 mm tief
 Streuwert 1.59, horizontal: 1.79, vertikal: 1.36

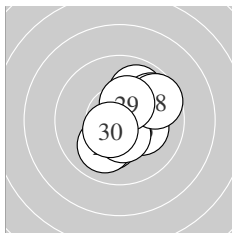

Serie 3:
 10.6 * 9.9 ↗ 9.8 ↗ 10.2 * 10.0 ↙
 10.2 * 10.5 * 9.7 ↗ 10.4 * 10.5 *
 beste Teiler 88.6 (21.) 108.9 (30.) 124.1 (27.)
 Trefferlage 0.74 mm rechts, 0.02 mm tief
 Streuwert 1.48, horizontal: 1.40, vertikal: 1.55

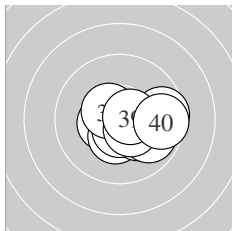

Serie 4:
 10.5 * 10.4 * 10.2 * 9.6 → 9.9 ↘
 10.6 * 10.5 * 10.5 * 10.6 * 9.6 →
 beste Teiler 87.0 (36.) 88.8 (39.) 109.2 (37.)
 Trefferlage 1.00 mm rechts, 0.48 mm tief
 Streuwert 1.28, horizontal: 1.66, vertikal: 0.73

Unterschrift des Schuetzen

Meyton Elektronik

Ergebnis: **379.0** (361)
 Serien: 96.4 90.0 93.6 99.0
 Zaehler: 13 17 8 2 0 0 0 0 0 0
 Innenzehner: 8
 weiteste: 928 (11), 804 (22), 705 (35)
 beste Teiler 51.4 (36.) 86.0 (33.) 102.0 (10.)
 Trefferlage 1.82 mm links, 0.62 mm tief
 Streuwert 2.66, horizontal: 3.01, vertikal: 2.26

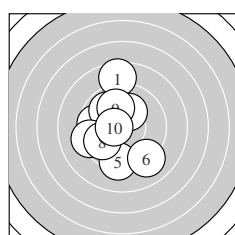
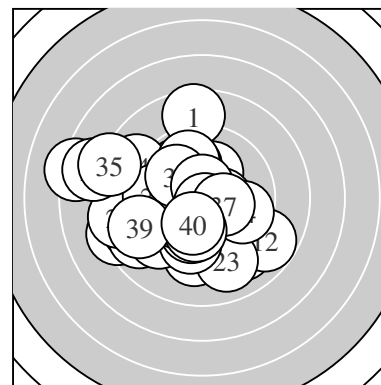

Serie 1:
 8.6 ↑ 10.2 * 9.7 ← 9.9 ↘ 9.3 ↓
 9.1 ↘ 9.3 ← 9.8 ↙ 10.0 ↑ 10.5 *
 beste Teiler 102.0 (10.) 194.4 (2.) 245.1 (9.)
 Trefferlage 1.07 mm links, 0.16 mm hoch
 Streuwert 2.54, horizontal: 1.94, vertikal: 3.03

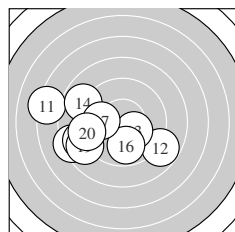

Serie 2:
 7.2 ← 8.8 ↘ 10.3 * 8.9 ↘ 8.3 ←
 9.8 ↓ 9.9 ← 8.8 ← 8.8 ↙ 9.2 ←
 beste Teiler 168.0 (13.) 256.5 (17.) 277.8 (16.)
 Trefferlage 2.98 mm links, 1.09 mm tief
 Streuwert 3.16, horizontal: 4.00, vertikal: 1.99

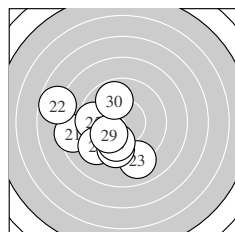

Serie 3:
 8.5 ← 7.7 ← 9.0 ↓ 10.1 ↙ 9.6 ←
 9.3 ↙ 9.6 ↓ 9.9 ↓ 10.1 ↙ 9.8 ↖
 beste Teiler 216.8 (29.) 220.0 (24.) 254.6 (28.)
 Trefferlage 2.44 mm links, 1.22 mm tief
 Streuwert 2.52, horizontal: 2.76, vertikal: 2.25

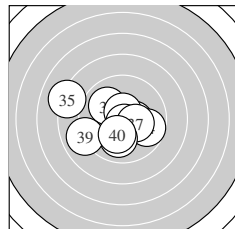

Serie 4:
 10.4 * 10.0 ↘ 10.6 * 9.7 → 8.1 ↖
 10.7 * 10.3 * 10.0 ↓ 9.0 ← 10.2 *
 beste Teiler 51.4 (36.) 86.0 (33.) 136.3 (31.)
 Trefferlage 0.80 mm links, 0.34 mm tief
 Streuwert 2.32, horizontal: 2.87, vertikal: 1.57

Unterschrift des Schuetzen

Meyton Elektronik

Ergebnis: **403.8** (386)
 Serien: 101.1 100.7 100.3 101.7
 Zaehler: 26 14 0 0 0 0 0 0 0 0
 Innenzehner: 19
 weiteste: 433 (15), 371 (29), 345 (39)
 beste Teiler 66.0 (18.) 76.0 (12.) 84.3 (10.)
 Trefferlage 0.27 mm rechts, 0.05 mm hoch
 Streuwert 1.65, horizontal: 1.94, vertikal: 1.29

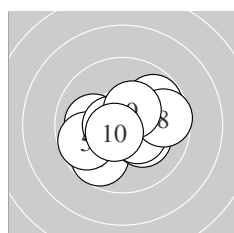
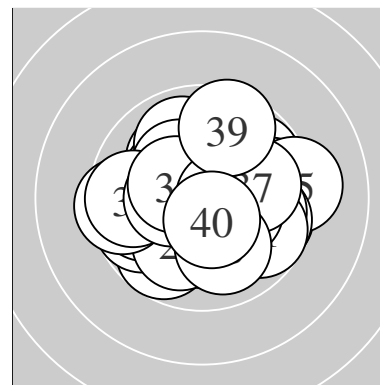

Serie 1:
 9.7 ↙ 10.2 * 9.8 ↗ 10.0 ← 9.7 ←
 10.6 * 10.4 * 9.7 → 10.4 * 10.6 *
 beste Teiler 84.3 (10.) 87.0 (6.) 138.4 (7.)
 Trefferlage 0.06 mm rechts, 0.23 mm tief
 Streuwert 1.67, horizontal: 2.03, vertikal: 1.22

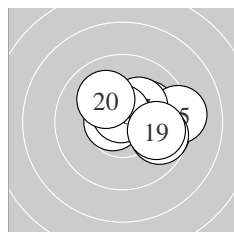

Serie 2:
 9.7 → 10.6 * 10.1 ↗ 10.5 * 9.2 →
 9.7 → 10.2 * 10.7 * 9.9 → 10.1 ↘
 beste Teiler 66.0 (18.) 76.0 (12.) 118.0 (14.)
 Trefferlage 1.46 mm rechts, 0.33 mm hoch
 Streuwert 1.43, horizontal: 1.80, vertikal: 0.94

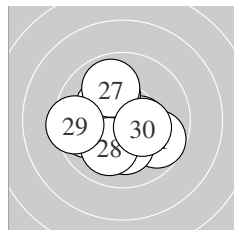

Serie 3:
 9.7 ↘ 10.4 * 10.1 ↖ 9.9 ← 10.2 *
 10.3 * 9.9 ↖ 10.0 ↓ 9.5 ← 10.3 *
 beste Teiler 132.2 (22.) 163.8 (30.) 174.6 (26.)
 Trefferlage 0.49 mm links, 0.20 mm tief
 Streuwert 1.76, horizontal: 1.95, vertikal: 1.56

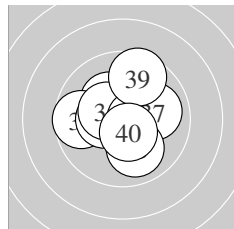

Serie 4:
 10.3 * 9.7 ← 10.4 * 10.3 * 10.4 *
 10.5 * 10.0 → 10.0 ↓ 9.6 ↑ 10.5 *
 beste Teiler 103.0 (36.) 111.4 (40.) 135.9 (35.)
 Trefferlage 0.05 mm rechts, 0.33 mm hoch
 Streuwert 1.57, horizontal: 1.69, vertikal: 1.45

Unterschrift des Schuetzen

Meyton Elektronik

Ergebnis: **386.5** (368)
 Serien: 96.9 95.7 95.4 98.5
 Zaehler: 15 19 5 1 0 0 0 0 0 0
 Innenzehner: 12
 weiteste: 881 (1), 595 (29), 551 (15)
 beste Teiler 74.9 (33.) 80.0 (19.) 103.9 (22.)
 Trefferlage 1.12 mm links, 0.14 mm hoch
 Streuwert 2.47, horizontal: 2.94, vertikal: 1.90

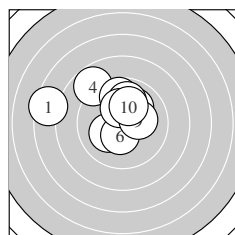
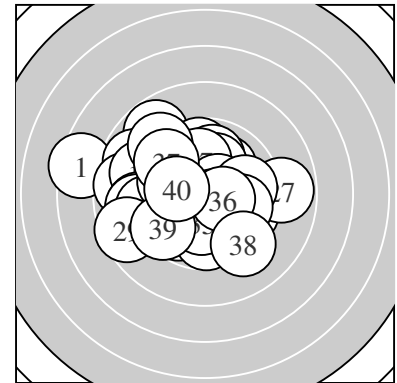

Serie 1:
 7.4 ↙ 10.0 ↗ 10.2 * 8.8 ↘ 9.7 ↑
 10.4 * 9.9 ↑ 10.2 * 10.2 * 10.1 ↑
 beste Teiler 140.0 (6.) 177.2 (8.) 185.1 (9.)
 Trefferlage 1.03 mm links, 1.52 mm hoch
 Streuwert 2.49, horizontal: 3.05, vertikal: 1.76

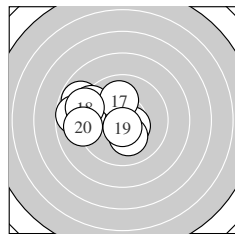

Serie 2:
 8.8 ↘ 10.5 * 9.4 ↘ 10.2 * 8.7 ←
 9.3 ← 10.0 ↑ 9.1 ↙ 10.6 * 9.1 ←
 beste Teiler 80.0 (19.) 116.4 (12.) 197.0 (14.)
 Trefferlage 2.58 mm links, 0.50 mm hoch
 Streuwert 2.08, horizontal: 2.55, vertikal: 1.45

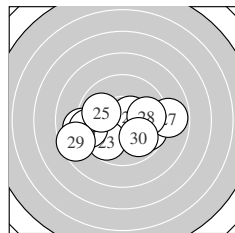

Serie 3:
 9.1 ← 10.5 * 9.8 ↙ 9.3 ← 9.9 ↘
 9.7 ↘ 8.8 → 9.8 → 8.6 ← 9.9 ↘
 beste Teiler 103.9 (22.) 259.9 (25.) 268.8 (30.)
 Trefferlage 0.46 mm links, 0.78 mm tief
 Streuwert 2.75, horizontal: 3.68, vertikal: 1.25

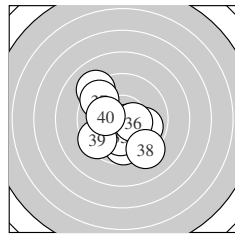

Serie 4:
 9.9 ↘ 9.1 ↘ 10.7 * 9.7 ↓ 10.2 *
 10.4 * 9.6 ↘ 9.2 ↘ 9.5 ↙ 10.2 *
 beste Teiler 74.9 (33.) 127.2 (36.) 199.1 (40.)
 Trefferlage 0.39 mm links, 0.66 mm tief
 Streuwert 2.19, horizontal: 2.17, vertikal: 2.21

Unterschrift des Schuetzen

Meyton Elektronik