

Ergebnis: **531** (557.3)
 Serien: 92 85 90 88 88 88
 Zähler: 15 25 16 4 0 0 0 0 0
 Innenzehner: 6
 Weitester: 3091 (56.), 2922 (37.), 2783 (40.)
 beste Teiler: 144.8 (35.), 203.5 (32.), 406.1 (27.)
 Trefferlage: 1.88 mm rechts, 1.11 mm tief
 Streuwert: 10.53, horizontal: 10.91, vertikal: 10.15

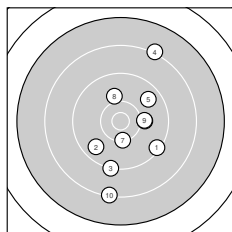
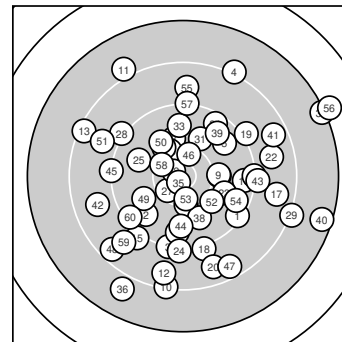

Serie 1:

9.3 ↘ 9.7 ↙ 9.2 ↓ 8.2 ↗ 9.7 ↗
 10.1 → 10.3 ↓ 10.0 ↑ 10.1 → 8.3 ↓

beste Teiler: 547.1 (7.), 683.4 (9.), 694.0 (6.)
 Trefferlage: 2.76 mm rechts, 2.12 mm tief
 Streuwert: 9.34, horizontal: 6.31, vertikal: 11.61

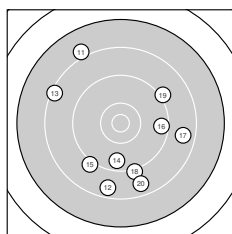

Serie 2:

8.0 ↘ 8.6 ↓ 8.4 ↖ 9.6 ↓ 9.1 ↙
 9.5 → 8.7 → 9.1 ↓ 9.1 ↗ 8.7 ↓

beste Teiler: 1080.3 (14.), 1175.8 (16.), 1444.3 (18.)
 Trefferlage: 0.78 mm rechts, 3.93 mm tief
 Streuwert: 12.33, horizontal: 11.68, vertikal: 12.94

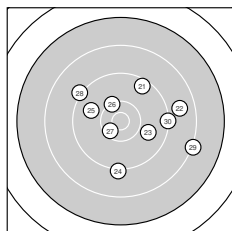

Serie 3:

9.5 ↗ 8.8 → 9.9 ↘ 9.2 ↓ 9.8 ↖
 10.3 ↖ 10.4 * 9.2 ↖ 8.2 ↘ 9.3 →

beste Teiler: 406.1 (27.), 543.8 (26.), 855.5 (23.)
 Trefferlage: 3.91 mm rechts, 0.21 mm hoch
 Streuwert: 9.34, horizontal: 10.94, vertikal: 7.40

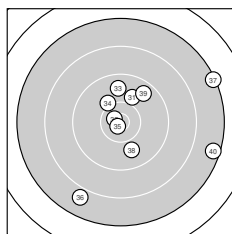

Serie 4:

10.0 ↗ 10.7 * 9.7 ↑ 10.1 ↖ 10.8 *
 7.9 ↙ 7.3 ↗ 9.9 ↓ 9.6 ↗ 7.5 →

beste Teiler: 144.8 (35.), 203.5 (32.), 657.5 (34.)
 Trefferlage: 4.76 mm rechts, 0.46 mm hoch
 Streuwert: 11.52, horizontal: 12.48, vertikal: 10.48

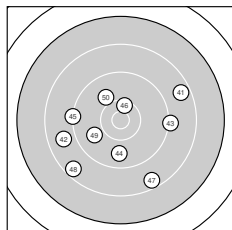

Serie 5:

8.6 ↗ 8.8 ← 9.2 → 9.8 ↓ 9.2 ←
 10.4 * 8.5 ↓ 8.5 ↙ 9.9 ↙ 10.0 ↖

beste Teiler: 432.7 (46.), 777.7 (50.), 862.6 (49.)
 Trefferlage: 1.39 mm links, 3.17 mm tief
 Streuwert: 10.37, horizontal: 11.92, vertikal: 8.54

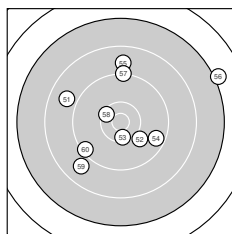

Serie 6:

8.9 ↖ 10.0 ↘ 10.4 * 9.6 ↘ 8.8 ↑
 7.1 ↗ 9.2 ↑ 10.4 * 8.8 ↙ 9.4 ↙

beste Teiler: 438.7 (53.), 462.7 (58.), 733.3 (52.)
 Trefferlage: 0.49 mm rechts, 1.85 mm hoch
 Streuwert: 11.44, horizontal: 12.49, vertikal: 10.29



Ergebnis: **507** (533.1)
Serien: 89 87 79 89 82 81
Zähler: 11 19 18 10 2 0 0 0 0 0
Innenzehner: 2
Weiteste: 3653 (48.), 3425 (30.), 3184 (28.)
beste Teiler: 249.4 (1.), 262.4 (37.), 499.4 (20.)
Trefferlage: 6.80 mm links, 1.60 mm tief
Streuwert: 12.31, horizontal: 12.27, vertikal: 12.35

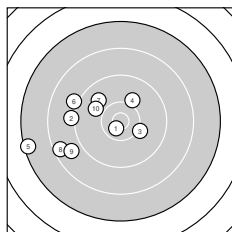
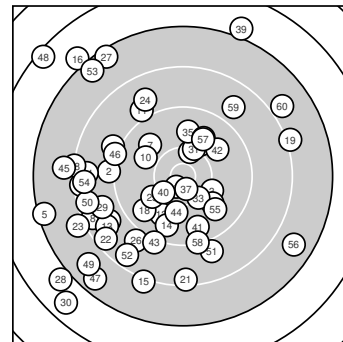

Serie 1:

10.6 *	9.1 ←	10.1 ↘	10.1 ↗	7.4 ←
9.1 ↙	9.8 ↘	8.5 ↙	8.8 ↙	9.9 ↘

beste Teiler: 249.4 (1.), 646.6 (3.), 718.1 (4.)
Trefferlage: 9.47 mm links, 0.66 mm tief
Streuwert: 8.48, horizontal: 10.30, vertikal: 6.16

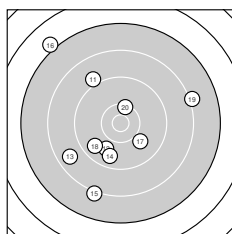

Serie 2:

9.0 ↘	9.9 ↙	8.7 ↙	9.7 ↓	8.2 ↓
7.0 ↘	10.0 ↘	9.7 ↙	8.1 →	10.3 ↑

beste Teiler: 499.4 (20.), 797.6 (17.), 871.4 (12.)
Trefferlage: 3.86 mm links, 1.18 mm tief
Streuwert: 12.41, horizontal: 11.67, vertikal: 13.11

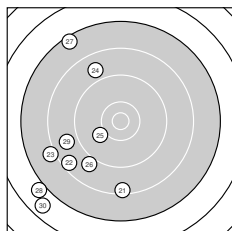

Serie 3:

8.4 ↓	8.5 ↙	8.1 ↙	8.8 ↘	10.0 ↙
9.0 ↙	7.4 ↘	7.0 ↙	8.8 ↙	6.7 ↙

beste Teiler: 735.5 (25.), 1585.9 (26.), 1695.4 (24.)
Trefferlage: 13.74 mm links, 7.26 mm tief
Streuwert: 12.47, horizontal: 8.06, vertikal: 15.69

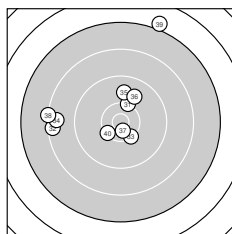

Serie 4:

10.2 ↗	8.4 ←	10.3 ↘	8.6 ←	9.8 ↑
9.9 ↗	10.6 *	8.2 ←	7.0 ↑	10.3 ↙

beste Teiler: 262.4 (37.), 504.0 (40.), 527.5 (33.)
Trefferlage: 4.21 mm links, 4.21 mm hoch
Streuwert: 10.90, horizontal: 11.77, vertikal: 9.95

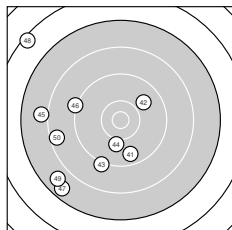

Serie 5:

9.6 ↓	9.9 ↗	9.2 ↓	10.0 ↓	8.0 ←
9.2 ↙	7.6 ↙	6.4 ↘	7.7 ↙	8.5 ←

beste Teiler: 730.6 (44.), 866.0 (42.), 1049.7 (41.)
Trefferlage: 11.74 mm links, 3.83 mm tief
Streuwert: 12.44, horizontal: 11.75, vertikal: 13.09

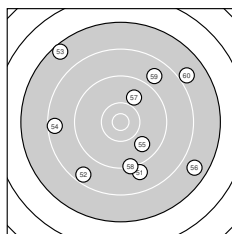

Serie 6:

9.0 ↓	8.6 ↙	7.5 ↘	8.5 ←	9.8 ↘
7.7 ↘	9.9 ↗	9.3 ↓	8.8 ↗	7.9 ↗

beste Teiler: 834.1 (57.), 919.3 (55.), 1349.9 (58.)
Trefferlage: 2.21 mm rechts, 0.91 mm tief
Streuwert: 14.14, horizontal: 14.37, vertikal: 13.90



Ergebnis: **544** (573.2)
 Serien: 88 91 92 90 91 92
 Zähler: 17 32 9 2 0 0 0 0 0
 Innenzehner: 7
 Weitester: 2657 (11.), 2624 (1.), 2347 (32.)
 beste Teiler: 233.0 (28.), 250.1 (8.), 281.6 (49.)
 Trefferlage: 2.54 mm links, 0.91 mm tief
 Streuwert: 8.63, horizontal: 9.39, vertikal: 7.79

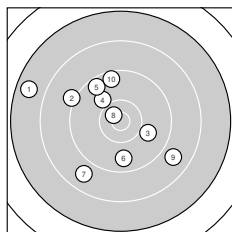
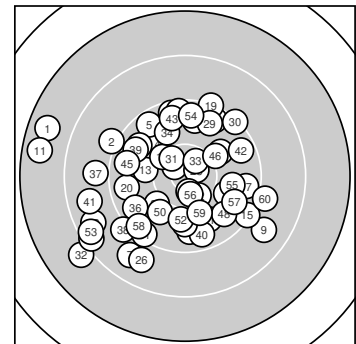

Serie 1:
 7.7 ↙ 9.1 ↖ 9.9 ↗
 9.7 ↓ 8.8 ↘ 10.6 *
 beste Teiler: 250.1 (8.), 759.9 (4.), 804.9 (3.)
 Trefferlage: 4.11 mm links, 0.61 mm hoch
 Streuwert: 10.06, horizontal: 10.81, vertikal: 9.25

10.0 ↖ 9.5 ↖
 8.8 ↘ 9.5 ↑

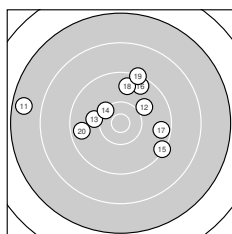

Serie 2:
 7.6 ↙ 10.0 ↗ 10.0 ↖
 9.5 ↗ 9.6 → 9.7 ↑
 beste Teiler: 534.1 (14.), 722.7 (13.), 776.3 (12.)
 Trefferlage: 0.73 mm links, 3.55 mm hoch
 Streuwert: 9.27, horizontal: 11.54, vertikal: 6.22

10.3 ↖ 9.3 ↘
 9.3 ↑ 9.6 ←

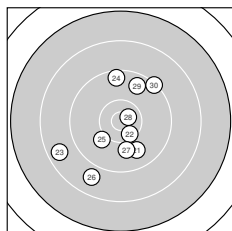

Serie 3:
 9.8 ↘ 10.4 * 8.6 ↖
 8.8 ↘ 10.0 ↓ 10.7 *
 beste Teiler: 233.0 (28.), 424.5 (22.), 710.6 (25.)
 Trefferlage: 0.65 mm links, 1.53 mm tief
 Streuwert: 8.33, horizontal: 7.38, vertikal: 9.18

9.5 ↑ 10.1 ↘
 9.6 ↑ 9.3 ↘

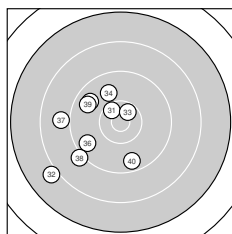

Serie 4:
 10.5 * 8.0 ↖ 10.5 *
 9.6 ↖ 8.9 ← 9.1 ↖
 beste Teiler: 334.0 (33.), 398.0 (31.), 851.2 (34.)
 Trefferlage: 7.26 mm links, 1.53 mm tief
 Streuwert: 7.48, horizontal: 7.17, vertikal: 7.79

9.9 ↑ 9.7 ↖
 9.7 ↖ 9.6 ↓

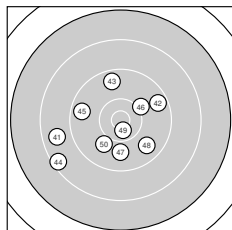

Serie 5:
 8.7 ↖ 9.6 ↗ 9.6 ↑
 10.1 ↗ 9.9 ↓ 9.7 ↘
 beste Teiler: 281.6 (49.), 657.8 (46.), 788.9 (50.)
 Trefferlage: 2.80 mm links, 1.94 mm tief
 Streuwert: 8.33, horizontal: 9.53, vertikal: 6.91

8.4 ↖ 9.6 ↖
 10.6 * 10.0 ↘

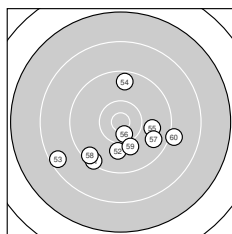

Serie 6:
 9.4 ↘ 10.0 ↓ 8.5 ↖
 10.5 * 9.7 ↘ 9.4 ↖
 beste Teiler: 339.4 (56.), 711.7 (59.), 782.5 (52.)
 Trefferlage: 0.33 mm rechts, 4.65 mm tief
 Streuwert: 7.92, horizontal: 9.31, vertikal: 6.24

9.6 ↑ 9.9 →
 10.1 ↓ 9.1 →



Ergebnis: **518** (546.3)
Serien: 82 82 88 88 93 85
Zähler: 13 23 15 7 2 0 0 0 0 0
Innenzehner: 6
Weiteste: 3459 (6.), 3434 (53.), 3007 (12.)
beste Teiler: 182.3 (37.), 242.1 (40.), 305.3 (1.)
Trefferlage: 5.35 mm links, 1.23 mm tief
Streuwert: 11.33, horizontal: 10.22, vertikal: 12.34

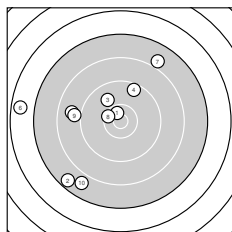
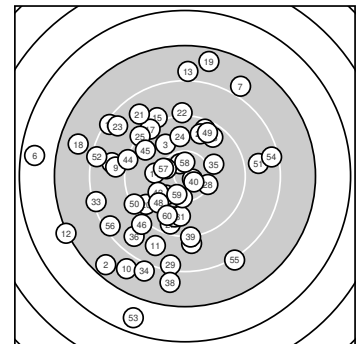

Serie 1:
 10.6 * 7.6 ↙ 9.9 ↘ 9.5 ↗ 8.8 ←
 6.6 ← 7.9 ↗ 10.4 * 9.0 ← 7.8 ↘
beste Teiler: 305.3 (1.), 457.0 (8.), 853.5 (3.)
Trefferlage: 9.07 mm links, 1.15 mm hoch
Streuwert: 13.07, horizontal: 13.34, vertikal: 12.80

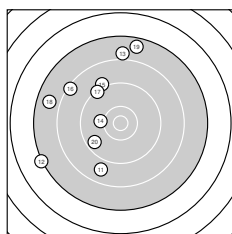

Serie 2:
 8.8 ↘ 7.2 ← 8.0 ↑ 10.1 ← 9.1 ↘
 8.3 ↘ 9.3 ↘ 7.8 ← 7.6 ↑ 9.6 ↘
beste Teiler: 689.5 (14.), 1096.3 (20.), 1333.8 (17.)
Trefferlage: 9.92 mm links, 5.85 mm hoch
Streuwert: 12.47, horizontal: 10.23, vertikal: 14.36

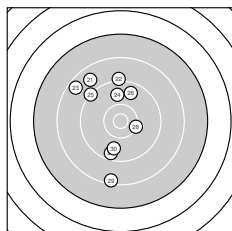

Serie 3:
 8.8 ↘ 9.1 ↑ 8.6 ↘ 9.8 ↑ 9.2 ↘
 9.7 ↑ 9.5 ↓ 10.3 → 8.4 ↓ 9.8 ↓
beste Teiler: 555.5 (28.), 908.9 (24.), 958.5 (30.)
Trefferlage: 3.79 mm links, 2.54 mm hoch
Streuwert: 9.79, horizontal: 6.43, vertikal: 12.25

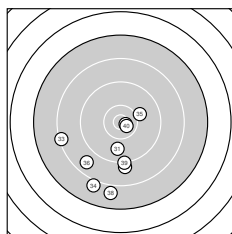

Serie 4:
 9.8 ↓ 9.0 ↓ 8.3 ← 8.0 ↓ 10.1 →
 8.7 ↘ 10.7 * 7.9 ↓ 9.2 ↓ 10.6 *
beste Teiler: 182.3 (37.), 242.1 (40.), 711.4 (35.)
Trefferlage: 3.24 mm links, 10.29 mm tief
Streuwert: 8.59, horizontal: 8.11, vertikal: 9.05

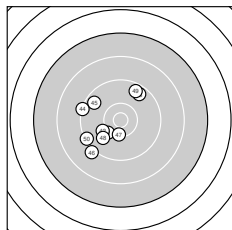

Serie 5:
 10.2 ↘ 10.1 ← 9.6 ↗ 9.3 ← 9.6 ↘
 9.1 ↘ 10.3 ↓ 9.9 ↘ 9.6 ↗ 9.3 ↘
beste Teiler: 495.5 (47.), 611.6 (41.), 714.9 (42.)
Trefferlage: 4.90 mm links, 0.78 mm tief
Streuwert: 6.97, horizontal: 6.67, vertikal: 7.26

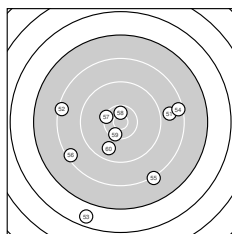

Serie 6:
 8.8 → 8.4 ← 6.7 ↓ 8.4 → 8.2 ↘
 8.4 ↘ 10.3 ← 10.6 * 10.4 * 9.7 ↓
beste Teiler: 318.0 (58.), 456.7 (59.), 521.6 (57.)
Trefferlage: 1.19 mm links, 5.91 mm tief
Streuwert: 12.92, horizontal: 13.59, vertikal: 12.21



Ergebnis: **522** (547.0)
 Serien: 83 88 87 89 85 90
 Zähler: 12 26 16 4 2 0 0 0 0 0
 Innenzehner: 2
 Weitester: 3437 (48.), 3334 (1.), 3115 (23.)
 beste Teiler: 264.6 (39.), 273.7 (22.), 579.9 (40.)
 Trefferlage: 2.38 mm links, 3.05 mm hoch
 Streuwert: 11.31, horizontal: 12.15, vertikal: 10.40

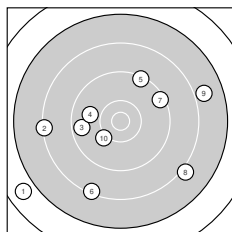
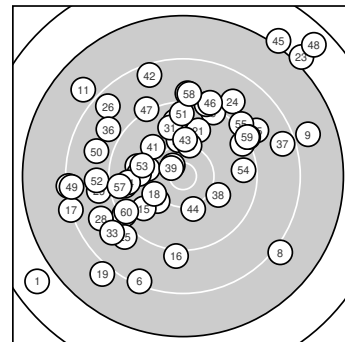

Serie 1:
 6.8 ↙ 8.3 ← 9.6 ← 9.9 ← 9.3 ↗
 8.3 ↘ 9.4 ↗ 8.1 ↘ 7.9 → 10.1 ↙
 beste Teiler: 659.0 (10.), 865.9 (4.), 1091.2 (3.)
 Trefferlage: 2.24 mm links, 3.39 mm tief
 Streuwert: 14.01, horizontal: 16.41, vertikal: 11.11

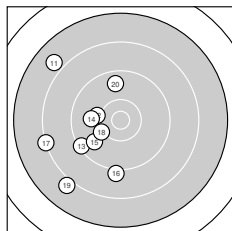

Serie 2:
 7.9 ↘ 10.1 ← 9.3 ↙ 9.9 ← 9.8 ↙
 9.1 ↓ 8.2 ← 10.2 ↙ 8.0 ↘ 9.7 ↑
 beste Teiler: 625.8 (18.), 667.3 (12.), 815.9 (14.)
 Trefferlage: 9.51 mm links, 2.77 mm tief
 Streuwert: 8.74, horizontal: 6.71, vertikal: 10.39

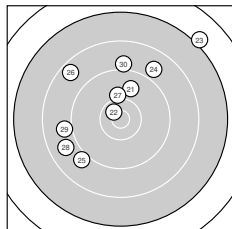

Serie 3:
 9.8 ↑ 10.6 * 7.1 ↗ 8.9 ↗ 9.0 ↙
 8.6 ↘ 10.1 ↑ 8.8 ↙ 9.0 ← 9.0 ↑
 beste Teiler: 273.7 (22.), 671.0 (27.), 893.9 (21.)
 Trefferlage: 2.34 mm links, 5.95 mm hoch
 Streuwert: 11.45, horizontal: 12.07, vertikal: 10.78

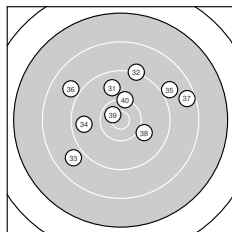

Serie 4:
 9.8 ↑ 9.2 ↑ 8.9 ↙ 9.7 ← 8.9 ↗
 8.9 ↘ 8.5 → 10.0 ↘ 10.6 * 10.2 ↑
 beste Teiler: 264.6 (39.), 579.9 (40.), 742.1 (38.)
 Trefferlage: 0.25 mm rechts, 3.75 mm hoch
 Streuwert: 9.21, horizontal: 10.89, vertikal: 7.14

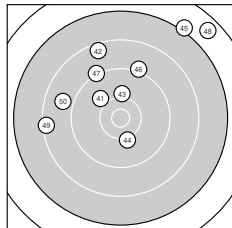

Serie 5:
 10.0 ↘ 8.5 ↑ 10.1 ↑ 10.2 ↓ 7.1 ↗
 9.1 ↑ 9.2 ↘ 6.7 ↗ 8.4 ← 8.9 ←
 beste Teiler: 637.9 (44.), 680.1 (43.), 779.3 (41.)
 Trefferlage: 0.59 mm links, 10.29 mm hoch
 Streuwert: 12.29, horizontal: 13.85, vertikal: 10.49

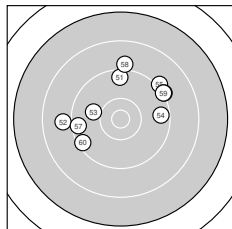

Serie 6:
 9.5 ↑ 8.9 ← 10.0 ↘ 9.5 → 9.1 ↗
 9.2 ↗ 9.5 ← 9.0 ↑ 9.2 ↗ 9.4 ↙
 beste Teiler: 780.5 (53.), 1128.3 (54.), 1162.1 (51.)
 Trefferlage: 0.11 mm rechts, 4.49 mm hoch
 Streuwert: 9.17, horizontal: 11.03, vertikal: 6.80



Ergebnis: **512** (541.2)
 Serien: 83 80 90 87 85 87
 Zähler: 11 23 15 9 2 0 0 0 0
 Innenzehner: 5
 Weitester: 3709 (48.), 3557 (6.), 3141 (10.)
 beste Teiler: 87.1 (27.), 168.0 (25.), 413.2 (5.)
 Trefferlage: 2.82 mm links, 1.68 mm hoch
 Streuwert: 12.32, horizontal: 11.60, vertikal: 12.99

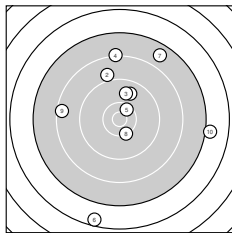
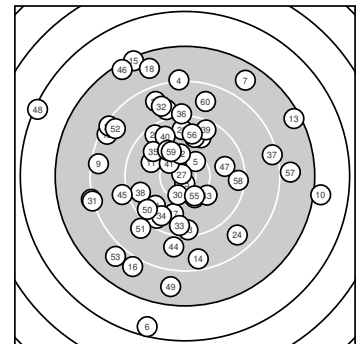

Serie 1:

9.8 ↗	9.0 ↖	9.8 ↗	8.2 ↑	10.4 *
6.5 ↓	7.7 ↗	10.3 ↓	8.4 ←	7.0 →

beste Teiler: 413.2 (5.), 542.0 (8.), 914.6 (3.)
 Trefferlage: 2.13 mm rechts, 3.94 mm hoch
 Streuwert: 15.07, horizontal: 13.47, vertikal: 16.52

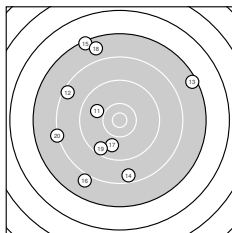

Serie 2:

9.9 ↖	8.4 ↖	7.4 ↗	8.5 ↓	7.3 ↘
8.0 ↘	9.8 ↓	7.7 ↖	9.5 ↘	8.2 ←

beste Teiler: 836.5 (11.), 899.0 (17.), 1164.0 (19.)
 Trefferlage: 6.00 mm links, 1.38 mm hoch
 Streuwert: 15.03, horizontal: 12.96, vertikal: 16.84

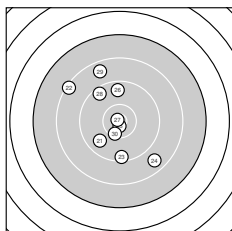

Serie 3:

9.8 ↙	8.3 ↖	9.4 ↓	8.7 ↘	10.7 *
9.6 ↑	10.8 *	9.5 ↖	8.7 ↖	10.4 *

beste Teiler: 87.1 (27.), 168.0 (25.), 460.7 (30.)
 Trefferlage: 2.81 mm links, 1.07 mm hoch
 Streuwert: 9.21, horizontal: 7.53, vertikal: 10.63

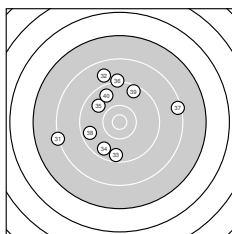

Serie 4:

8.2 ←	8.8 ↖	9.5 ↓	9.6 ↘	9.8 ↖
9.2 ↑	8.4 →	9.6 ←	9.5 ↗	9.7 ↖

beste Teiler: 919.1 (35.), 1020.9 (40.), 1055.4 (34.)
 Trefferlage: 3.11 mm links, 3.08 mm hoch
 Streuwert: 10.24, horizontal: 10.61, vertikal: 9.86

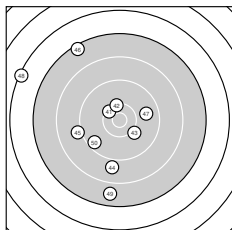

Serie 5:

10.4 *	10.3 ↑	10.1 ↘	8.9 ↓	9.1 ←
7.4 ↖	9.8 →	6.3 ↖	7.8 ↓	9.5 ↘

beste Teiler: 465.4 (41.), 519.7 (42.), 668.6 (43.)
 Trefferlage: 6.75 mm links, 0.77 mm tief
 Streuwert: 13.29, horizontal: 12.09, vertikal: 14.40

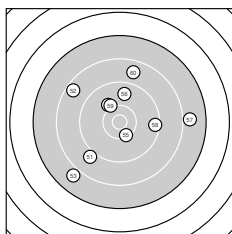

Serie 6:

9.0 ↙	8.5 ↖	7.9 ↙	10.1 ↖	10.3 ↓
9.7 ↑	7.9 →	9.4 →	10.1 ↖	8.7 ↑

beste Teiler: 501.7 (55.), 645.5 (59.), 711.4 (54.)
 Trefferlage: 0.41 mm links, 1.43 mm hoch
 Streuwert: 11.67, horizontal: 12.47, vertikal: 10.82



Ergebnis: **555** (581.1)
 Serien: 91 93 93 92 94 92
 Zähler: 27 23 8 2 0 0 0 0 0 0
 Innenzehner: 11
 Weitester: 2870 (43.), 2450 (32.), 2303 (9.)
 beste Teiler: 133.8 (2.), 190.0 (31.), 254.1 (51.)
 Trefferlage: 0.38 mm links, 2.54 mm hoch
 Streuwert: 8.25, horizontal: 8.17, vertikal: 8.33

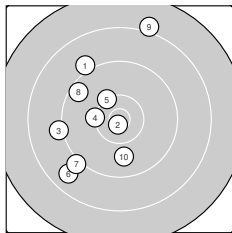
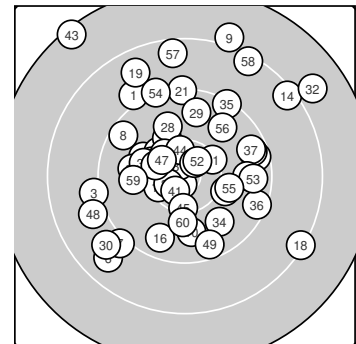

Serie 1:
 9.1 ↘ 10.8 * 9.1 ← 10.2 ← 10.2 ↘
 8.7 ↗ 9.1 ↗ 9.5 ↘ 8.1 ↑ 9.8 ↓
 beste Teiler: 133.8 (2.), 563.1 (5.), 585.5 (4.)
 Trefferlage: 5.59 mm links, 1.00 mm hoch
 Streuwert: 9.03, horizontal: 6.70, vertikal: 10.88

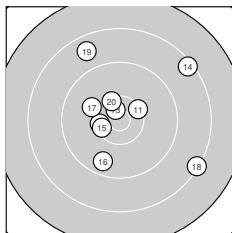

Serie 2:
 10.3 ↗ 10.4 ← 10.6 * 8.4 ↗ 10.4 *
 9.6 ↓ 10.0 ↖ 8.3 ↘ 8.7 ↘ 10.3 ↖
 beste Teiler: 262.7 (13.), 458.0 (15.), 477.9 (12.)
 Trefferlage: 0.86 mm rechts, 1.85 mm hoch
 Streuwert: 8.92, horizontal: 9.27, vertikal: 8.55

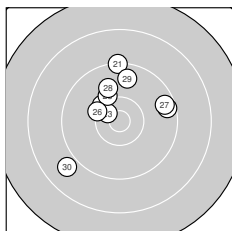

Serie 3:
 9.3 ↑ 10.2 ↘ 10.5 * 9.5 → 10.1 ↘
 10.2 ↖ 9.5 → 9.9 ↖ 9.7 ↑ 8.9 ↗
 beste Teiler: 339.2 (23.), 570.4 (22.), 577.6 (26.)
 Trefferlage: 0.69 mm links, 4.17 mm hoch
 Streuwert: 6.84, horizontal: 7.19, vertikal: 6.47

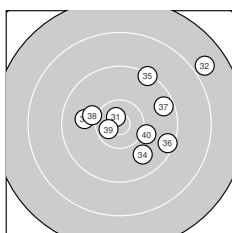

Serie 4:
 10.7 * 7.9 ↗ 9.9 ← 9.8 ↘ 9.3 ↗
 9.4 ↘ 9.5 → 10.1 ↖ 10.6 * 10.1 ↘
 beste Teiler: 190.0 (31.), 289.5 (39.), 678.8 (40.)
 Trefferlage: 4.21 mm rechts, 1.91 mm hoch
 Streuwert: 7.80, horizontal: 8.84, vertikal: 6.60

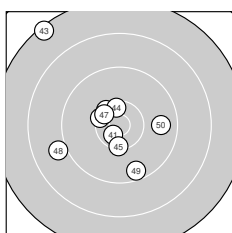

Serie 5:
 10.6 * 10.3 ↘ 7.4 ↘ 10.4 * 10.3 ↓
 10.3 ↖ 10.4 * 9.0 ← 9.5 ↓ 9.7 →
 beste Teiler: 275.9 (41.), 420.3 (44.), 445.8 (47.)
 Trefferlage: 3.28 mm links, 1.02 mm hoch
 Streuwert: 8.50, horizontal: 8.07, vertikal: 8.91

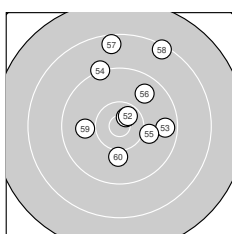

Serie 6:
 10.6 * 10.6 * 9.6 → 9.2 ↑ 10.0 →
 9.7 ↗ 8.5 ↑ 8.4 ↗ 9.9 ← 10.0 ↓
 beste Teiler: 254.1 (51.), 308.3 (52.), 724.7 (55.)
 Trefferlage: 2.21 mm rechts, 5.28 mm hoch
 Streuwert: 7.75, horizontal: 6.25, vertikal: 9.01



Ergebnis: **355** (376.4)
 Serien: 88 90 92 85
 Zähler: 11 14 14 1 0 0 0 0 0 0
 Innenzehner: 4
 Weitester: 2825 (36.), 1969 (17.), 1961 (37.)
 beste Teiler: 215.5 (32.), 281.3 (13.), 302.4 (30.)
 Trefferlage: 2.16 mm links, 2.90 mm tief
 Streuwert: 9.38, horizontal: 8.36, vertikal: 10.31

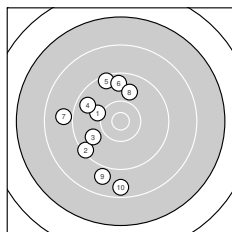
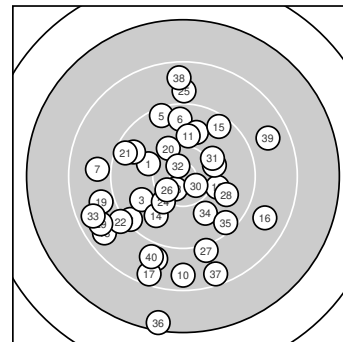

Serie 1:
 10.1 ↖ 9.3 ↙ 9.8 ↙ 9.6 ↖ 9.4 ↖
 9.6 ↑ 8.9 ← 9.9 ↑ 8.9 ↓ 8.6 ↓
 beste Teiler: 698.1 (1.), 870.4 (8.), 903.3 (3.)
 Trefferlage: 5.73 mm links, 0.83 mm tief
 Streuwert: 8.53, horizontal: 5.57, vertikal: 10.70

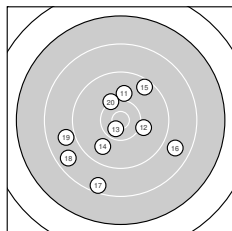

Serie 2:
 10.0 ↑ 10.1 → 10.6 * 9.8 ↙ 9.5 ↗
 8.8 ↘ 8.5 ↓ 8.6 ↙ 8.9 ← 10.2 ↖
 beste Teiler: 281.3 (13.), 598.0 (20.), 689.0 (12.)
 Trefferlage: 1.62 mm links, 3.19 mm tief
 Streuwert: 9.25, horizontal: 9.72, vertikal: 8.76

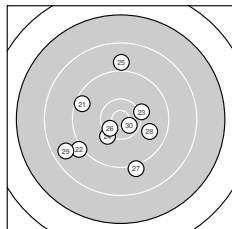

Serie 3:
 9.5 ↖ 9.1 ↙ 10.2 → 10.2 ↙ 8.9 ↑
 10.4 * 9.1 ↓ 9.8 → 8.7 ↙ 10.6 *
 beste Teiler: 302.4 (30.), 401.4 (26.), 615.0 (24.)
 Trefferlage: 2.39 mm links, 2.18 mm tief
 Streuwert: 8.31, horizontal: 8.18, vertikal: 8.44

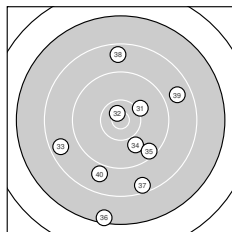

Serie 4:
 10.1 ↗ 10.7 * 8.6 ↙ 9.9 ↘ 9.4 ↘
 7.4 ↓ 8.5 ↓ 8.6 ↑ 8.7 → 8.9 ↓
 beste Teiler: 215.5 (32.), 655.9 (31.), 824.5 (34.)
 Trefferlage: 1.08 mm rechts, 5.39 mm tief
 Streuwert: 11.61, horizontal: 9.16, vertikal: 13.62



Ergebnis: **353** (370.0)
 Serien: 89 89 90 85
 Zähler: 9 19 8 4 0 0 0 0 0 0
 Innenzehner: 2
 Weitester: 3026 (38.), 2829 (4.), 2429 (37.)
 beste Teiler: 61.4 (3.), 454.9 (33.), 526.5 (35.)
 Trefferlage: 2.86 mm links, 1.22 mm hoch
 Streuwert: 10.74, horizontal: 10.64, vertikal: 10.83

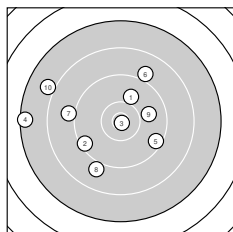
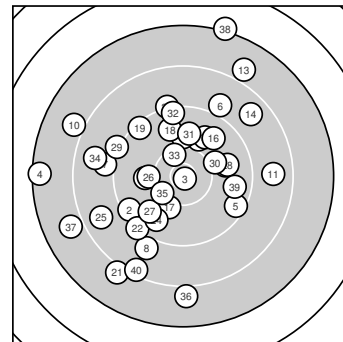

Serie 1:
 10.0 ↗ 9.4 ↖ 10.9 * 7.4 ← 9.5 ↘
 9.0 ↗ 9.0 ← 9.0 ↓ 9.9 → 8.0 ↖
 beste Teiler: 61.4 (3.), 786.7 (1.), 861.2 (9.)
 Trefferlage: 5.33 mm links, 0.91 mm hoch
 Streuwert: 11.19, horizontal: 13.42, vertikal: 8.39

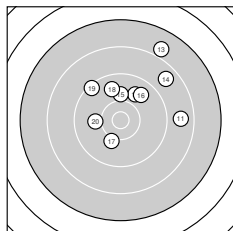

Serie 2:
 8.7 → 9.9 ↗ 7.9 ↗ 8.7 ↗ 10.0 ↑
 9.7 ↗ 10.1 ↓ 9.8 ↑ 9.4 ↘ 10.0 ←
 beste Teiler: 671.6 (17.), 748.9 (20.), 768.0 (15.)
 Trefferlage: 3.23 mm rechts, 6.86 mm hoch
 Streuwert: 8.31, horizontal: 9.04, vertikal: 7.50

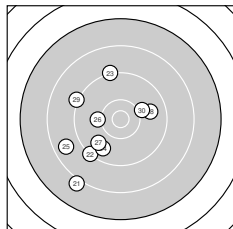

Serie 3:
 8.1 ↖ 9.2 ↖ 9.2 ↑ 9.7 ↓ 8.7 ↖
 10.1 ← 9.8 ↖ 9.8 → 9.2 ↖ 10.1 →
 beste Teiler: 678.0 (26.), 688.5 (30.), 906.1 (28.)
 Trefferlage: 5.77 mm links, 2.87 mm tief
 Streuwert: 8.81, horizontal: 8.10, vertikal: 9.47

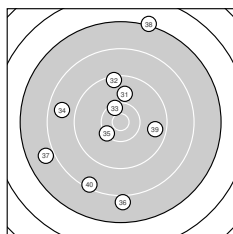

Serie 4:
 9.9 ↑ 9.4 ↑ 10.4 * 8.7 ← 10.3 ↖
 8.0 ↓ 7.9 ↖ 7.2 ↑ 9.6 → 8.4 ↓
 beste Teiler: 454.9 (33.), 526.5 (35.), 847.9 (31.)
 Trefferlage: 3.60 mm links, 0.01 mm hoch
 Streuwert: 13.06, horizontal: 10.26, vertikal: 15.36



Ergebnis: **360** (375.6)
 Serien: 92 89 89 90
 Zähler: 9 22 9 0 0 0 0 0 0 0
 Innenzehner: 1
 Weitester: 2338 (9.), 2243 (29.), 2133 (4.)
 beste Teiler: 453.7 (8.), 510.2 (11.), 642.2 (3.)
 Trefferlage: 2.28 mm links, 0.08 mm hoch
 Streuwert: 9.46, horizontal: 8.60, vertikal: 10.25

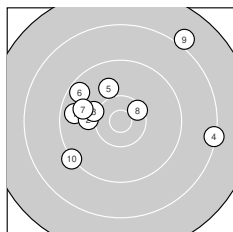
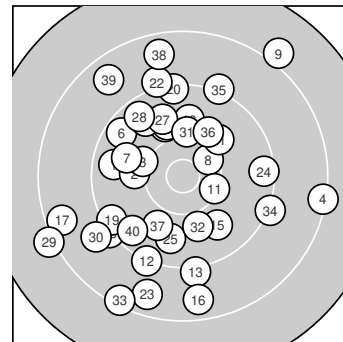

Serie 1:
 9.6 ← 10.0 ← 10.1 ↖ 8.3 → 10.0 ↑
 9.5 ↘ 9.8 ↖ 10.4 * 8.0 ↗ 9.2 ↘
 beste Teiler: 453.7 (8.), 642.2 (3.), 728.9 (2.)
 Trefferlage: 1.59 mm links, 2.99 mm hoch
 Streuwert: 9.36, horizontal: 11.16, vertikal: 7.10

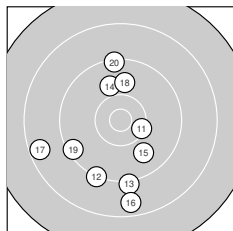

Serie 2:
 10.3 ↘ 9.2 ↓ 9.1 ↓ 9.9 ↑ 9.8 ↘
 8.6 ↓ 8.5 ← 9.9 ↑ 9.4 ↙ 9.3 ↑
 beste Teiler: 510.2 (11.), 808.7 (14.), 853.0 (18.)
 Trefferlage: 2.30 mm links, 3.87 mm tief
 Streuwert: 9.12, horizontal: 7.36, vertikal: 10.59

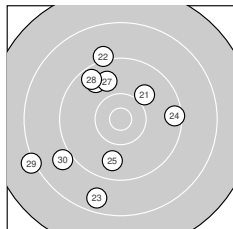

Serie 3:
 10.0 ↗ 9.1 ↑ 8.6 ↓ 9.4 → 9.8 ↓
 9.7 ↘ 9.8 ↑ 9.6 ↘ 8.1 ↙ 9.0 ↙
 beste Teiler: 768.6 (21.), 908.4 (27.), 954.4 (25.)
 Trefferlage: 4.20 mm links, 0.00 mm
 Streuwert: 9.84, horizontal: 8.87, vertikal: 10.73

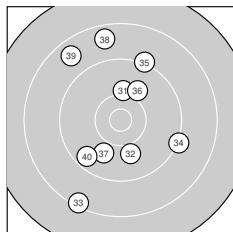

Serie 4:
 10.1 ↑ 10.0 ↓ 8.3 ↓ 9.2 → 9.2 ↑
 10.0 ↗ 9.9 ↓ 8.6 ↑ 8.7 ↘ 9.6 ↙
 beste Teiler: 667.5 (31.), 764.6 (36.), 788.4 (32.)
 Trefferlage: 1.04 mm links, 1.22 mm hoch
 Streuwert: 10.14, horizontal: 7.52, vertikal: 12.21



Ergebnis: **366** (385.4)
 Serien: 96 93 89 88
 Zähler: 16 16 6 2 0 0 0 0 0 0
 Innenzehner: 7
 Weitester: 2572 (36.), 2473 (31.), 2319 (19.)
 beste Teiler: 82.7 (9.), 238.8 (3.), 263.8 (27.)
 Trefferlage: 2.01 mm links, 3.83 mm hoch
 Streuwert: 8.11, horizontal: 7.39, vertikal: 8.76

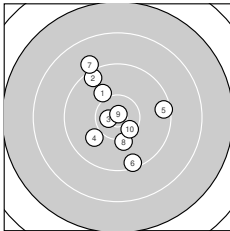
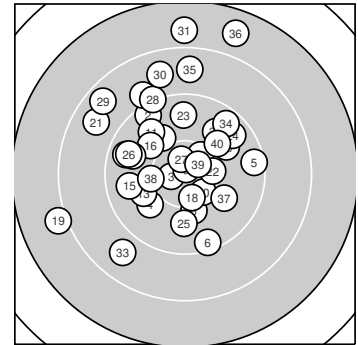

Serie 1:
 10.0 ↘ 9.5 ↘ 10.7 * 10.0 ↙ 9.4 →
 9.4 ↓ 9.0 ↘ 10.1 ↓ 10.8 * 10.4 *
 beste Teiler: 82.7 (9.), 238.8 (3.), 438.4 (10.)
 Trefferlage: 0.50 mm links, 0.60 mm hoch
 Streuwert: 6.89, horizontal: 5.91, vertikal: 7.75

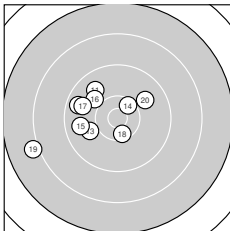

Serie 2:
 9.8 ↘ 9.6 ↖ 10.0 ↙ 10.4 * 9.7 ←
 10.0 ↘ 9.8 ↖ 10.4 * 8.1 ← 9.9 ↗
 beste Teiler: 420.2 (18.), 425.8 (14.), 769.1 (16.)
 Trefferlage: 5.83 mm links, 0.92 mm hoch
 Streuwert: 6.68, horizontal: 8.08, vertikal: 4.91

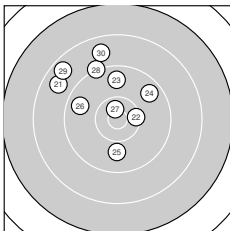

Serie 3:
 8.7 ↖ 10.4 → 9.7 ↑ 9.6 ↗ 9.9 ↓
 9.7 ↖ 10.6 * 9.2 ↘ 8.6 ↖ 8.7 ↗
 beste Teiler: 263.8 (27.), 478.8 (22.), 846.1 (25.)
 Trefferlage: 3.69 mm links, 6.63 mm hoch
 Streuwert: 7.53, horizontal: 7.65, vertikal: 7.40

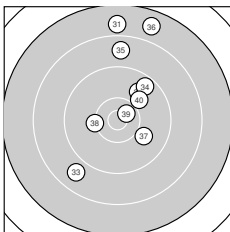

Serie 4:
 7.9 ↑ 9.8 ↗ 8.8 ↙ 9.6 ↗ 8.7 ↑
 7.7 ↑ 10.0 ↘ 10.2 ← 10.6 * 10.0 ↗
 beste Teiler: 281.4 (39.), 591.1 (38.), 765.4 (40.)
 Trefferlage: 1.97 mm rechts, 7.15 mm hoch
 Streuwert: 9.76, horizontal: 6.20, vertikal: 12.33



Ergebnis: **366** (388.3)
 Serien: 90 95 91 90
 Zähler: 14 19 6 1 0 0 0 0 0 0
 Innenzehner: 6
 Weitester: 2467 (38.), 2205 (34.), 1918 (5.)
 beste Teiler: 163.6 (27.), 208.5 (13.), 216.9 (37.)
 Trefferlage: 0.46 mm rechts, 0.37 mm hoch
 Streuwert: 8.11, horizontal: 7.74, vertikal: 8.46

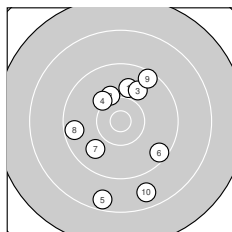
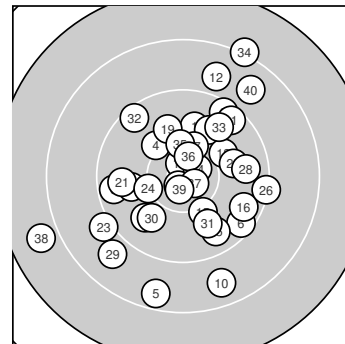

Serie 1:
 9.9 ↑ 10.1 ↘ 9.9 ↗ 10.1 ↘ 8.6 ↓
 9.5 ↘ 9.8 ↙ 9.5 ← 9.4 ↗ 8.7 ↓
 beste Teiler: 653.9 (4.), 658.6 (2.), 815.0 (1.)
 Trefferlage: 0.03 mm links, 1.53 mm tief
 Streuwert: 8.78, horizontal: 6.56, vertikal: 10.55

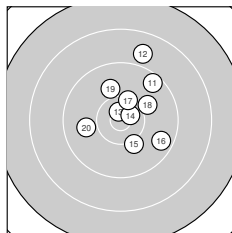

Serie 2:
 9.5 ↗ 8.9 ↑ 10.7 * 10.6 * 10.1 ↘
 9.6 ↘ 10.3 ↑ 10.0 ↗ 10.0 ↑ 9.9 ←
 beste Teiler: 208.5 (13.), 260.7 (14.), 509.3 (17.)
 Trefferlage: 2.52 mm rechts, 3.16 mm hoch
 Streuwert: 5.96, horizontal: 5.28, vertikal: 6.57

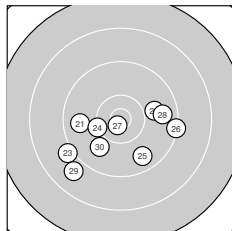

Serie 3:
 9.7 ← 9.9 → 9.1 ↙ 10.2 ← 9.7 ↘
 9.3 → 10.7 * 9.7 → 8.9 ↙ 9.9 ↙
 beste Teiler: 163.6 (27.), 587.9 (24.), 831.2 (30.)
 Trefferlage: 0.82 mm links, 3.94 mm tief
 Streuwert: 7.46, horizontal: 9.42, vertikal: 4.76

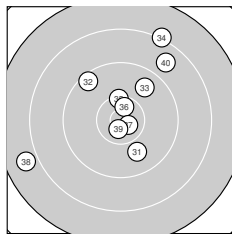

Serie 4:
 9.9 ↘ 9.4 ↘ 9.7 ↗ 8.2 ↗ 10.3 ↑
 10.5 * 10.7 * 7.9 ← 10.7 * 8.8 ↗
 beste Teiler: 216.9 (37.), 220.9 (39.), 328.2 (36.)
 Trefferlage: 0.17 mm rechts, 3.81 mm hoch
 Streuwert: 9.47, horizontal: 9.65, vertikal: 9.30



Ergebnis: **368** (384.1)
 Serien: 91 93 90 94
 Zähler: 17 14 9 0 0 0 0 0 0 0
 Innenzehner: 9
 Weitester: 2361 (25.), 2352 (3.), 2182 (1.)
 beste Teiler: 182.8 (10.), 196.6 (11.), 237.5 (31.)
 Trefferlage: 0.34 mm rechts, 1.88 mm tief
 Streuwert: 8.93, horizontal: 8.42, vertikal: 9.40

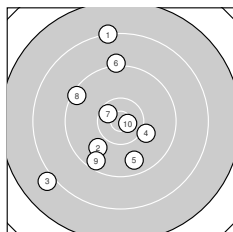
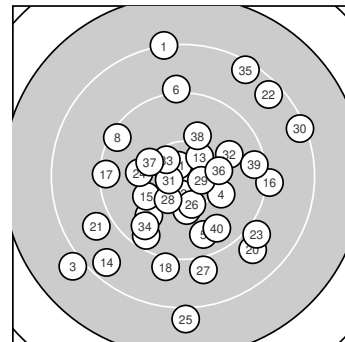

Serie 1:
 8.2 ↑ 9.9 ↙ 8.0 ↘
 9.1 ↑ 10.5 * 9.4 ↘
 beste Teiler: 182.8 (10.), 364.6 (7.), 697.8 (4.)
 Trefferlage: 3.67 mm links, 0.01 mm tief
 Streuwert: 9.54, horizontal: 7.14, vertikal: 11.45

10.1 ↘ 9.7 ↓
 9.5 ↙ 10.7 *

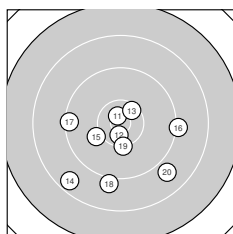

Serie 2:
 10.7 * 10.6 * 10.4 *
 9.2 → 9.4 ← 9.0 ↓
 beste Teiler: 196.6 (11.), 292.7 (12.), 419.5 (13.)
 Trefferlage: 0.62 mm links, 4.90 mm tief
 Streuwert: 7.85, horizontal: 8.87, vertikal: 6.68

8.6 ↙ 10.1 ↙
 10.2 ↓ 8.9 ↘

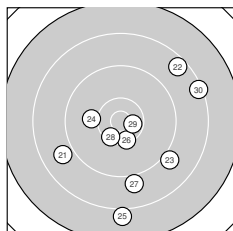

Serie 3:
 8.9 ↙ 8.5 ↗ 9.0 ↘
 10.3 ↓ 9.0 ↓ 10.4 *
 beste Teiler: 310.7 (29.), 460.7 (28.), 489.5 (26.)
 Trefferlage: 3.00 mm rechts, 4.43 mm tief
 Streuwert: 10.44, horizontal: 10.10, vertikal: 10.77

10.0 ← 8.0 ↓
 10.6 * 8.3 →

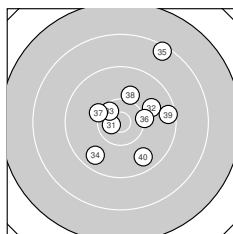

Serie 4:
 10.7 * 9.9 ↗ 10.5 *
 10.2 → 10.2 ↖ 10.1 ↑
 beste Teiler: 237.5 (31.), 385.3 (33.), 596.9 (37.)
 Trefferlage: 2.69 mm rechts, 1.82 mm hoch
 Streuwert: 6.99, horizontal: 6.56, vertikal: 7.39

9.7 ↙ 8.4 ↗
 9.5 → 9.7 ↘



Ergebnis: **368** (383.5)
 Serien: 89 93 94 92
 Zähler: 15 19 5 1 0 0 0 0 0 0
 Innenzehner: 5
 Weitester: 2736 (6.), 2235 (10.), 1981 (5.)
 beste Teiler: 133.8 (30.), 319.6 (24.), 384.3 (7.)
 Trefferlage: 1.62 mm links, 2.07 mm hoch
 Streuwert: 8.61, horizontal: 10.55, vertikal: 6.10

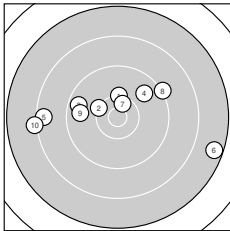
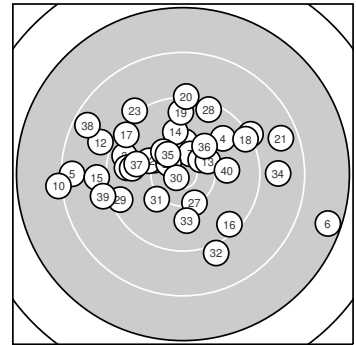

Serie 1:

10.2 ↑	10.2 ↖	9.6 ←	9.8 ↗	8.5 ←
7.5 →	10.5 *	9.2 ↗	9.7 ←	8.2 ←

beste Teiler: 384.3 (7.), 563.0 (2.), 581.0 (1.)
 Trefferlage: 2.07 mm links, 1.89 mm hoch
 Streuwert: 10.93, horizontal: 14.71, vertikal: 4.75

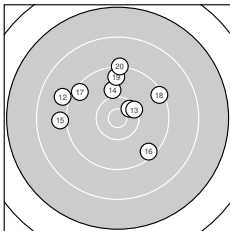

Serie 2:

10.4 *	9.0 ↖	10.3 ↗	10.0 ↑	9.0 ←
9.4 ↘	9.4 ↖	9.3 ↗	9.6 ↑	9.2 ↑

beste Teiler: 406.0 (11.), 501.8 (13.), 767.3 (14.)
 Trefferlage: 1.43 mm links, 4.68 mm hoch
 Streuwert: 7.92, horizontal: 9.21, vertikal: 6.38

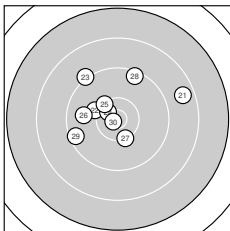

Serie 3:

8.6 →	10.1 ↖	9.2 ↘	10.6 *	10.3 ↘
9.8 ←	10.3 ↓	9.4 ↑	9.4 ←	10.8 *

beste Teiler: 133.8 (30.), 319.6 (24.), 532.2 (25.)
 Trefferlage: 1.81 mm links, 2.83 mm hoch
 Streuwert: 7.21, horizontal: 8.43, vertikal: 5.74

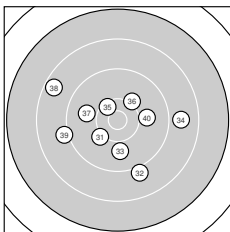

Serie 4:

10.1 ↗	9.0 ↓	9.9 ↓	8.8 →	10.4 *
10.2 ↗	9.9 ←	8.6 ↖	9.1 ←	10.0 →

beste Teiler: 445.4 (35.), 632.4 (36.), 647.1 (31.)
 Trefferlage: 1.16 mm links, 1.09 mm tief
 Streuwert: 8.79, horizontal: 10.44, vertikal: 6.74



Ergebnis: **348** (369.4)
 Serien: 83 88 91 86
 Zähler: 6 19 12 3 0 0 0 0 0 0
 Innenzehner: 3
 Weitester: 2755 (20.), 2492 (3.), 2429 (10.)
 beste Teiler: 79.4 (21.), 241.3 (12.), 465.5 (27.)
 Trefferlage: 0.05 mm links, 1.03 mm tief
 Streuwert: 10.67, horizontal: 9.96, vertikal: 11.33

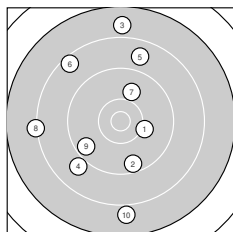
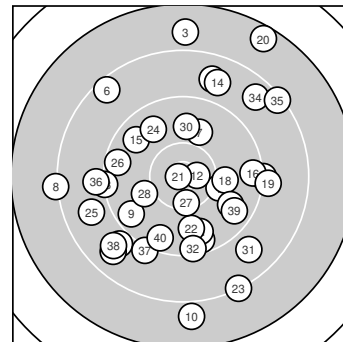

Serie 1:
 10.1 ↘ 9.5 ↓ 7.8 ↑ 8.9 ↙ 8.8 ↑
 8.5 ↖ 9.9 ↑ 8.2 ← 9.6 ↙ 7.9 ↓
 beste Teiler: 655.5 (1.), 811.6 (7.), 1107.0 (9.)
 Trefferlage: 3.58 mm links, 0.68 mm hoch
 Streuwert: 12.67, horizontal: 9.52, vertikal: 15.18

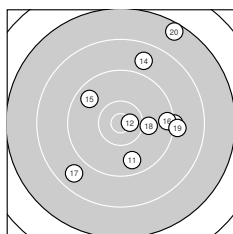

Serie 2:
 9.7 ↓ 10.6 * 9.2 → 8.8 ↑ 9.7 ↖
 9.4 → 8.7 ↙ 10.0 → 9.1 → 7.5 ↑
 beste Teiler: 241.3 (12.), 732.0 (18.), 1002.0 (11.)
 Trefferlage: 5.31 mm rechts, 2.23 mm hoch
 Streuwert: 10.17, horizontal: 9.33, vertikal: 10.95

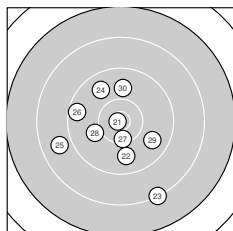

Serie 3:
 10.9 * 9.8 ↓ 8.2 ↓ 9.8 ↖ 8.8 ↙
 9.5 ← 10.4 * 10.0 ← 9.8 ↘ 9.9 ↑
 beste Teiler: 79.4 (21.), 465.5 (27.), 731.6 (28.)
 Trefferlage: 1.92 mm links, 2.82 mm tief
 Streuwert: 8.14, horizontal: 7.99, vertikal: 8.28

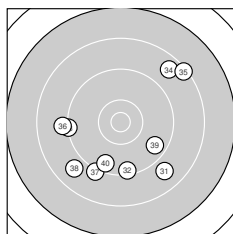

Serie 4:
 8.8 ↘ 9.4 ↓ 9.2 ← 8.6 ↗ 8.3 ↗
 9.1 ← 9.1 ↙ 8.8 ↙ 9.6 ↘ 9.5 ↓
 beste Teiler: 1072.5 (39.), 1137.4 (40.), 1265.0 (32.)
 Trefferlage: 0.01 mm links, 4.23 mm tief
 Streuwert: 11.08, horizontal: 11.78, vertikal: 10.33



Ergebnis: **359** (378.1)
 Serien: 87 91 89 92
 Zähler: 11 18 10 1 0 0 0 0 0 0
 Innenzehner: 7
 Weitester: 2438 (27.), 2154 (11.), 2071 (38.)
 beste Teiler: 331.7 (22.), 373.7 (31.), 394.8 (7.)
 Trefferlage: 1.68 mm links, 0.57 mm tief
 Streuwert: 9.45, horizontal: 10.56, vertikal: 8.19

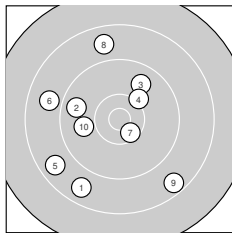
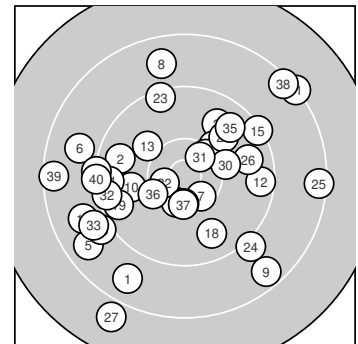

Serie 1:
 8.7 ↙ 9.7 ← 9.8 ↗
 8.9 ↖ 10.5 * 8.7 ↑
 beste Teiler: 394.8 (7.), 640.9 (4.), 841.3 (10.)
 Trefferlage: 3.73 mm links, 0.87 mm tief
 Streuwert: 9.98, horizontal: 9.45, vertikal: 10.47

10.2 ↗ 8.7 ↙
 8.5 ↘ 9.9 ←

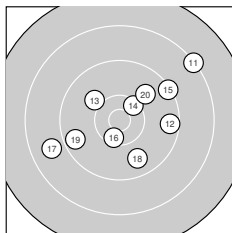

Serie 2:
 8.3 ↗ 9.5 → 10.0 ↘
 10.4 * 8.8 ← 9.7 ↘
 beste Teiler: 424.0 (16.), 461.9 (14.), 738.3 (13.)
 Trefferlage: 2.00 mm rechts, 0.96 mm hoch
 Streuwert: 8.80, horizontal: 10.29, vertikal: 6.98

10.4 * 9.3 ↗
 9.6 ← 9.9 ↗

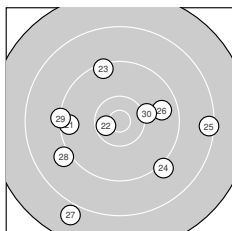

Serie 3:
 9.5 ← 10.5 * 9.4 ↑
 9.7 → 7.9 ↙ 9.0 ↙
 beste Teiler: 331.7 (22.), 649.1 (30.), 1002.4 (26.)
 Trefferlage: 0.96 mm links, 2.64 mm tief
 Streuwert: 10.61, horizontal: 11.95, vertikal: 9.06

9.1 ↘ 8.4 →
 9.3 ← 10.1 →

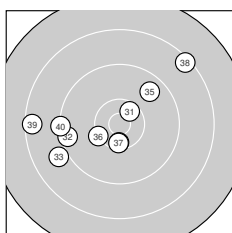

Serie 4:
 10.5 * 9.4 ← 9.0 ↙
 10.2 ↙ 10.4 * 8.4 ↗
 beste Teiler: 373.7 (31.), 421.2 (34.), 435.7 (37.)
 Trefferlage: 4.06 mm links, 0.23 mm hoch
 Streuwert: 8.96, horizontal: 10.90, vertikal: 6.45

10.4 * 9.7 ↗
 8.4 ← 9.3 ←



Ergebnis: **152** (160.7)
 Serien: 80 72
 Zähler: 3 6 3 2 3 1 1 1 0 0
 Innenzehner: 1
 Weitester: 6067 (11.), 5005 (6.), 4329 (2.)
 beste Teiler: 71.1 (1.), 695.0 (20.), 716.1 (10.)
 Trefferlage: 2.60 mm links, 5.32 mm hoch
 Streuwert: 19.92, horizontal: 8.97, vertikal: 26.71

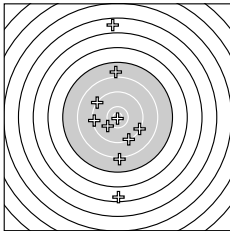
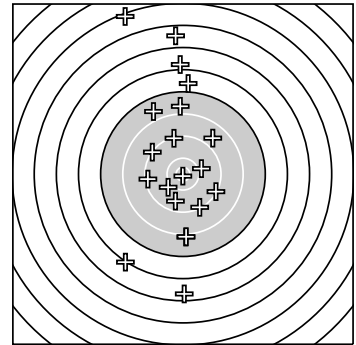

Serie 1:

10.9 *	5.5 ↓	7.9 ↑	9.2 ↘	9.4 ←
4.7 ↑	9.3 ↘	9.3 ↓	8.1 ↓	10.1 ↙

beste Teiler: 71.1 (1.), 716.1 (10.), 1279.7 (5.)
 Trefferlage: 1.33 mm links, 0.91 mm tief
 Streuwert: 18.61, horizontal: 7.32, vertikal: 25.28

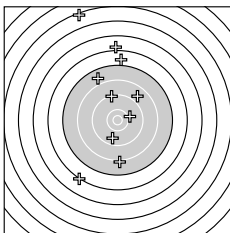

Serie 2:

3.4 ↖	6.9 ↑	9.7 ↓	8.8 ↗	7.8 ↖
6.0 ↑	6.2 ↙	9.3 ↑	8.1 ↓	10.1 →

beste Teiler: 695.0 (20.), 1012.2 (13.), 1336.1 (18.)
 Trefferlage: 3.88 mm links, 11.57 mm hoch
 Streuwert: 21.13, horizontal: 10.62, vertikal: 27.92



Ergebnis: **582.9** (556)
 Serien: 100.8 94.1 94.2 98.0 99.9 95.9
 Zähler: 25 27 7 1 0 0 0 0 0
 Innenzehner: 20
 Weitester: 770 (57.), 709 (12.), 585 (38.)
 beste Teiler: 51.6 (60.), 80.0 (37.), 80.2 (7.)
 Trefferlage: 0.68 mm rechts, 0.59 mm hoch
 Streuwert: 2.43, horizontal: 2.61, vertikal: 2.22

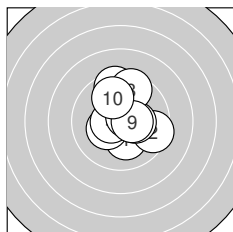
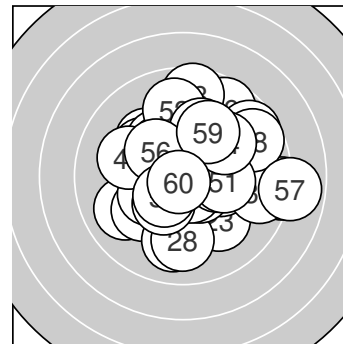

Serie 1:
 10.2 * 9.5 → 10.3 * 10.5 * 10.3 *
 9.5 ↑ 10.6 * 9.5 ↑ 10.5 * 9.9 ↗

beste Teiler: 80.2 (7.), 101.4 (4.), 124.0 (9.)
 Trefferlage: 0.47 mm rechts, 0.59 mm hoch
 Streuwert: 1.72, horizontal: 1.49, vertikal: 1.92

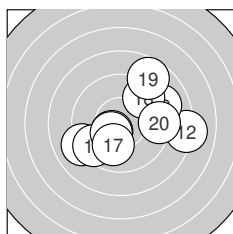

Serie 2:
 10.4 * 8.1 → 9.1 ↗ 9.1 ↙ 9.5 ↙
 10.4 * 10.0 ↓ 9.5 ↗ 8.7 ↗ 9.3 →

beste Teiler: 129.4 (11.), 143.5 (16.), 243.1 (17.)
 Trefferlage: 1.11 mm rechts, 0.02 mm tief
 Streuwert: 3.06, horizontal: 3.58, vertikal: 2.43

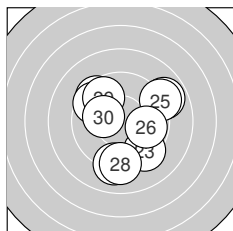

Serie 3:
 8.9 ↗ 9.1 ↓ 9.3 ↘ 9.5 ↘ 9.0 ↗
 9.8 → 9.6 ↘ 9.1 ↓ 9.7 ↘ 10.2 *

beste Teiler: 189.4 (30.), 281.1 (26.), 310.0 (29.)
 Trefferlage: 0.43 mm rechts, 0.06 mm tief
 Streuwert: 2.92, horizontal: 2.87, vertikal: 2.98

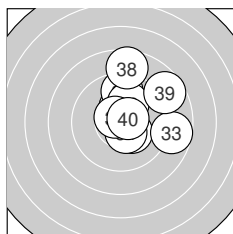

Serie 4:
 10.3 * 10.3 * 8.7 → 10.5 * 9.6 ↑
 10.1 ↗ 10.6 * 8.6 ↑ 8.7 ↗ 10.6 *

beste Teiler: 80.0 (37.), 87.6 (40.), 123.8 (34.)
 Trefferlage: 1.37 mm rechts, 1.34 mm hoch
 Streuwert: 2.17, horizontal: 2.03, vertikal: 2.29

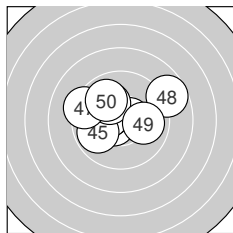

Serie 5:
 10.6 * 10.6 * 10.4 * 10.4 * 9.9 ↙
 10.1 ↘ 9.3 ↖ 8.7 ↗ 10.0 → 9.9 ↘

beste Teiler: 88.0 (42.), 96.3 (41.), 127.2 (43.)
 Trefferlage: 0.38 mm links, 0.66 mm hoch
 Streuwert: 2.01, horizontal: 2.55, vertikal: 1.24

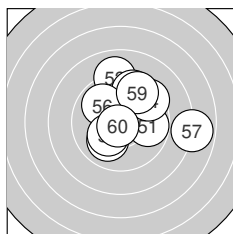

Serie 6:
 9.8 → 9.0 ↑ 9.5 ↑ 9.4 ↗ 10.0 ↙
 9.9 ↘ 7.9 → 10.2 * 9.5 ↗ 10.7 *

beste Teiler: 51.6 (60.), 192.3 (58.), 238.8 (55.)
 Trefferlage: 1.10 mm rechts, 1.03 mm hoch
 Streuwert: 2.64, horizontal: 2.92, vertikal: 2.32



Ergebnis: **151.2** (144)_{DNF}
Serien: 94.6 56.6
Zähler: 5 5 3 2 1 1 0 0 0 0
Innenzehner: 4
Weiteste: 1328 (12.), 1072 (9.), 908 (17.)
beste Teiler: 95.8 (5.), 113.7 (7.), 163.8 (1.)
Trefferlage: 0.35 mm rechts, 0.46 mm hoch
Streuwert: 4.49, horizontal: 5.67, vertikal: 2.88

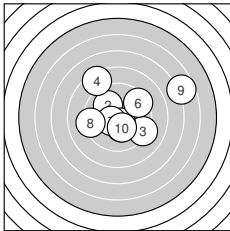
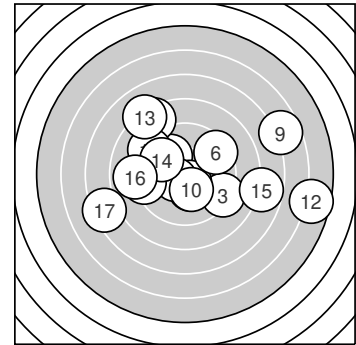

Serie 1:

10.3 *	10.0 ↘	9.2 ↘	8.4 ↘	10.6 *
9.4 ↗	10.5 *	9.2 ←	6.7 ↗	10.3 *

beste Teiler: 95.8 (5.), 113.7 (7.), 163.8 (1.)
Trefferlage: 0.87 mm rechts, 0.64 mm hoch
Streuwert: 3.43, horizontal: 4.03, vertikal: 2.69

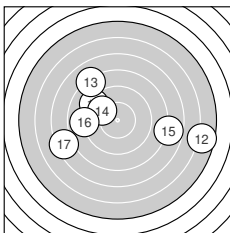

Serie 2:

9.2 ↘	5.6 →	8.1 ↘	9.8 ↘	7.7 →
8.9 ←	7.3 ←			

beste Teiler: 281.1 (14.), 441.5 (11.), 513.8 (16.)
Trefferlage: 0.39 mm links, 0.20 mm hoch
Streuwert: 5.97, horizontal: 7.75, vertikal: 3.34

DNF – Schütze hat den Wettkampf nicht beendet



Ergebnis: **618.3** (591)
 Serien: 102.8 102.9 101.8 104.9 103.4 102.5
 Zähler: 52 7 1 0 0 0 0 0 0
 Innenzehner: 44
 Weitester: 548 (30.), 382 (13.), 366 (52.)
 beste Teiler: 3.1 (12.), 17.0 (49.), 18.3 (23.)
 Trefferlage: 0.30 mm rechts, 0.15 mm hoch
 Streuwert: 1.34, horizontal: 1.54, vertikal: 1.11

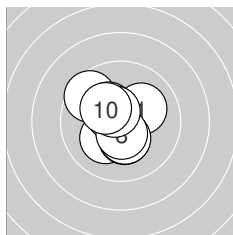
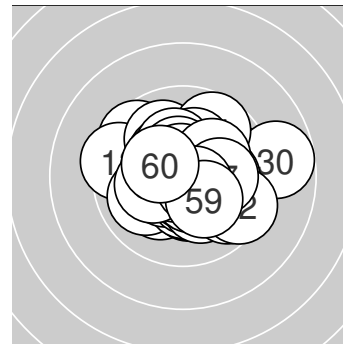

Serie 1:
 10.1 ↗ 9.6 ↘ 10.2 * 10.3 * 10.3 *
 10.6 * 10.3 * 10.5 * 10.6 * 10.3 *
 beste Teiler: 92.6 (6.), 100.7 (9.), 107.4 (8.)
 Trefferlage: 0.50 mm links, 0.14 mm hoch
 Streuwert: 1.31, horizontal: 1.23, vertikal: 1.38

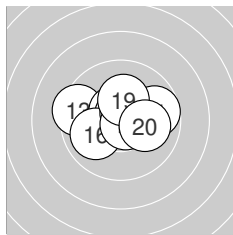

Serie 2:
 9.7 → 10.9 * 9.4 ← 10.6 * 10.7 *
 10.0 ← 10.6 * 10.7 * 10.2 * 10.1 →
 beste Teiler: 3.1 (12.), 53.0 (15.), 56.4 (18.)
 Trefferlage: 0.01 mm links, 0.33 mm hoch
 Streuwert: 1.47, horizontal: 1.90, vertikal: 0.84

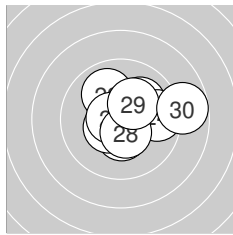

Serie 3:
 10.1 ↗ 10.0 ↘ 10.9 * 9.7 → 10.4 *
 10.5 * 10.6 * 10.5 * 10.3 * 8.8 →
 beste Teiler: 18.3 (23.), 77.6 (27.), 123.4 (28.)
 Trefferlage: 0.90 mm rechts, 0.32 mm hoch
 Streuwert: 1.68, horizontal: 2.07, vertikal: 1.17

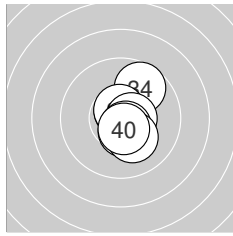

Serie 4:
 10.7 * 10.5 * 10.7 * 9.7 ↗ 10.6 *
 10.7 * 10.6 * 10.6 * 10.2 * 10.6 *
 beste Teiler: 57.3 (31.), 67.6 (33.), 70.7 (36.)
 Trefferlage: 0.58 mm rechts, 0.08 mm tief
 Streuwert: 0.95, horizontal: 0.54, vertikal: 1.23

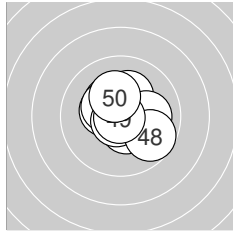

Serie 5:
 10.4 * 10.5 * 10.3 * 10.2 * 10.4 *
 10.1 → 10.7 * 9.7 ↘ 10.9 * 10.2 *
 beste Teiler: 17.0 (49.), 56.7 (47.), 116.7 (42.)
 Trefferlage: 0.14 mm rechts, 0.26 mm hoch
 Streuwert: 1.26, horizontal: 1.36, vertikal: 1.14

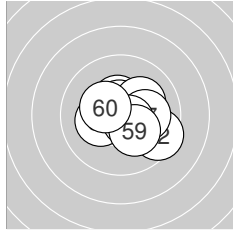

Serie 6:
 10.5 * 9.5 ↘ 10.6 * 10.2 * 10.3 *
 10.1 ↗ 10.1 → 10.6 * 10.2 * 10.4 *
 beste Teiler: 81.8 (53.), 82.8 (58.), 125.9 (51.)
 Trefferlage: 0.70 mm rechts, 0.05 mm tief
 Streuwert: 1.32, horizontal: 1.57, vertikal: 1.01



Ergebnis: **623.4** (593)
 Serien: 101.3 105.3 104.1 104.3 103.5 104.9
 Zähler: 53 7 0 0 0 0 0 0 0
 Innenzehner: 49
 Weitester: 324 (10.), 313 (44.), 296 (33.)
 beste Teiler: 11.0 (32.), 40.4 (40.), 47.3 (20.)
 Trefferlage: 0.13 mm links, 0.07 mm tief
 Streuwert: 1.13, horizontal: 1.24, vertikal: 1.01

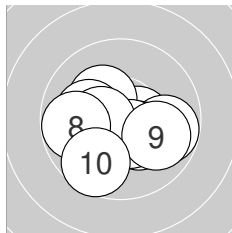
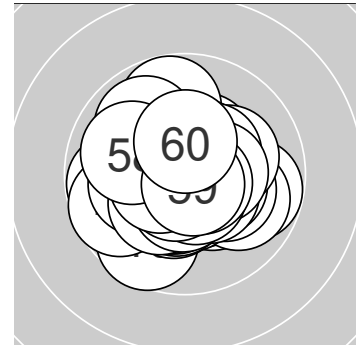

Serie 1:

10.5 *	9.8 →	10.3 *	10.1 ←	10.3 *
10.5 *	10.4 *	9.8 ←	9.9 →	9.7 ↙

beste Teiler: 109.3 (1.), 114.8 (6.), 127.4 (7.)
 Trefferlage: 0.09 mm links, 0.55 mm tief
 Streuwert: 1.59, horizontal: 1.97, vertikal: 1.08

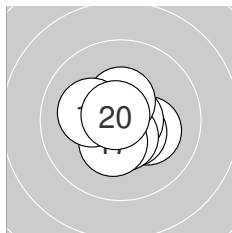

Serie 2:

10.2 *	10.7 *	10.8 *	10.5 *	10.7 *
10.5 *	10.4 *	10.5 *	10.2 *	10.8 *

beste Teiler: 47.3 (20.), 48.0 (13.), 55.0 (15.)
 Trefferlage: 0.06 mm rechts, 0.17 mm tief
 Streuwert: 0.89, horizontal: 0.94, vertikal: 0.83

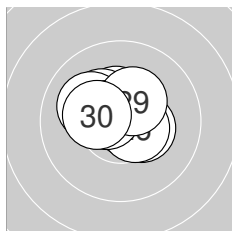

Serie 3:

10.5 *	10.7 *	10.4 *	10.3 *	10.4 *
10.5 *	10.1 ↖	10.6 *	10.3 *	10.3 *

beste Teiler: 57.2 (22.), 99.4 (28.), 105.1 (26.)
 Trefferlage: 0.15 mm links, 0.55 mm hoch
 Streuwert: 0.97, horizontal: 1.18, vertikal: 0.70

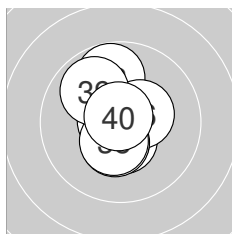

Serie 4:

10.5 *	10.9 *	9.8 ↑	10.5 *	10.7 *
10.4 *	10.4 *	10.4 *	9.9 ↘	10.8 *

beste Teiler: 11.0 (32.), 40.4 (40.), 58.3 (35.)
 Trefferlage: 0.27 mm links, 0.11 mm hoch
 Streuwert: 1.15, horizontal: 0.74, vertikal: 1.44

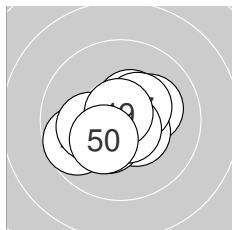

Serie 5:

10.5 *	10.2 *	10.4 *	9.7 ←	10.4 *
10.1 ←	10.4 *	10.7 *	10.8 *	10.3 *

beste Teiler: 47.8 (49.), 70.0 (48.), 122.4 (41.)
 Trefferlage: 0.18 mm links, 0.24 mm tief
 Streuwert: 1.24, horizontal: 1.48, vertikal: 0.95

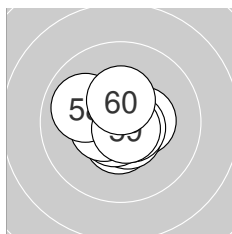

Serie 6:

10.5 *	10.6 *	10.4 *	10.6 *	10.6 *
10.6 *	10.5 *	10.0 ↖	10.7 *	10.4 *

beste Teiler: 56.2 (59.), 78.0 (56.), 78.2 (55.)
 Trefferlage: 0.18 mm links, 0.16 mm tief
 Streuwert: 0.92, horizontal: 1.04, vertikal: 0.79



Ergebnis: **582.3** (557)
 Serien: 98.9 100.3 97.1 98.3 92.1 95.6
 Zähler: 26 27 5 2 0 0 0 0 0
 Innenzehner: 16
 Weitestе: 999 (46.), 999 (54.), 617 (42.)
 beste Teiler: 19.0 (6.), 19.6 (26.), 20.0 (16.)
 Trefferlage: 0.42 mm links, 0.39 mm hoch
 Streuwert: 2.61, horizontal: 2.91, vertikal: 2.26

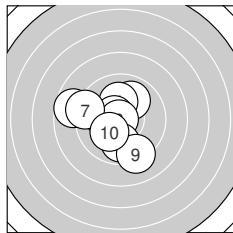
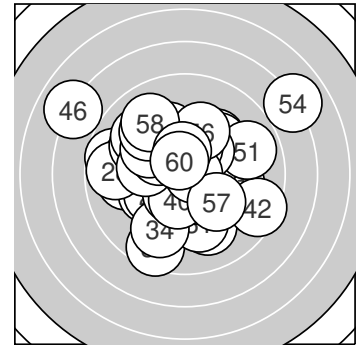

Serie 1:
 10.0 ↗ 10.1 ← 8.7 ← 10.1 ↑ 10.6 *
 10.9 * 9.2 ← 9.9 ↓ 9.2 ↓ 10.2 *
 beste Teiler: 19.0 (6.), 88.2 (5.), 195.4 (10.)
 Trefferlage: 1.12 mm links, 0.06 mm tief
 Streuwert: 2.15, horizontal: 2.25, vertikal: 2.04

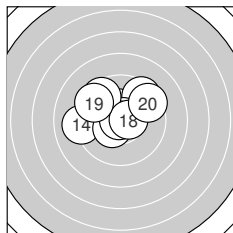

Serie 2:
 10.4 * 9.5 ↗ 10.8 * 9.1 ← 10.4 *
 10.9 * 9.6 ↘ 10.6 * 9.5 ↘ 9.5 ↗
 beste Teiler: 20.0 (16.), 49.5 (13.), 92.1 (18.)
 Trefferlage: 0.44 mm links, 0.99 mm hoch
 Streuwert: 1.94, horizontal: 2.38, vertikal: 1.36

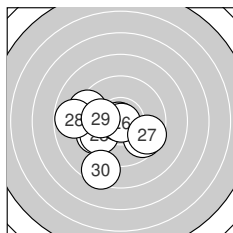

Serie 3:
 9.7 ↘ 9.6 ← 9.8 ← 10.9 * 9.3 ←
 10.9 * 9.6 ↘ 8.8 ← 10.0 ← 8.5 ↓
 beste Teiler: 19.6 (26.), 24.3 (24.), 233.3 (29.)
 Trefferlage: 1.37 mm links, 1.05 mm tief
 Streuwert: 2.35, horizontal: 2.70, vertikal: 1.94

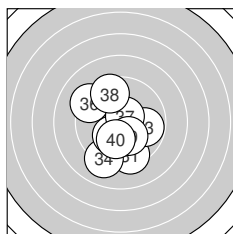

Serie 4:
 9.4 ↓ 10.1 ↓ 9.8 → 9.1 ↓ 10.2 *
 9.3 ↘ 10.6 * 9.5 ↑ 10.2 * 10.1 ↓
 beste Teiler: 84.4 (37.), 183.0 (35.), 184.9 (39.)
 Trefferlage: 0.38 mm links, 0.94 mm tief
 Streuwert: 2.12, horizontal: 1.79, vertikal: 2.41

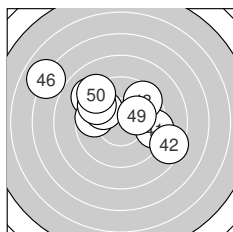

Serie 5:
 9.4 → 8.5 ↘ 9.5 ↗ 9.1 ↘ 9.7 ←
 7.0 ↘ 10.0 ↘ 9.6 ↘ 10.1 → 9.2 ↘
 beste Teiler: 202.2 (49.), 243.5 (47.), 308.5 (45.)
 Trefferlage: 0.88 mm links, 1.49 mm hoch
 Streuwert: 3.39, horizontal: 4.29, vertikal: 2.16

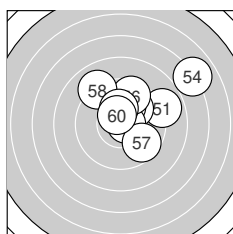

Serie 6:
 8.9 → 10.0 ↗ 10.1 ↑ 7.0 → 10.7 *
 9.5 ↑ 9.7 ↘ 9.0 ↘ 10.2 * 10.5 *
 beste Teiler: 65.0 (55.), 112.5 (60.), 180.2 (59.)
 Trefferlage: 1.63 mm rechts, 1.91 mm hoch
 Streuwert: 2.63, horizontal: 3.06, vertikal: 2.11



Ergebnis: **167.2** (157)
 Serien: 81.2 86.0
 Zähler: 2 6 5 3 2 2 0 0 0 0
 Innenzehner: 2
 Weitester: 1480 (15.), 1280 (1.), 1220 (9.)
 beste Teiler: 104.1 (12.), 114.0 (19.), 278.1 (8.)
 Trefferlage: 0.36 mm rechts, 1.68 mm hoch
 Streuwert: 5.25, horizontal: 5.56, vertikal: 4.92

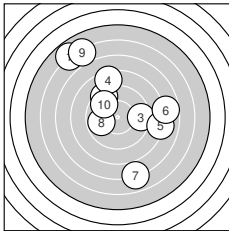
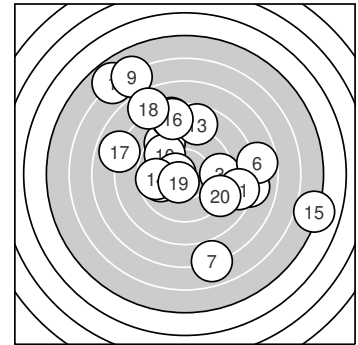

Serie 1:

5.8 ↘	9.3 ↘	9.4 →	8.4 ↑	8.1 →
7.7 →	6.9 ↓	9.8 ←	6.1 ↘	9.7 ↘

beste Teiler: 278.1 (8.), 308.3 (10.), 387.0 (3.)
 Trefferlage: 0.06 mm links, 2.19 mm hoch
 Streuwert: 5.63, horizontal: 5.32, vertikal: 5.94

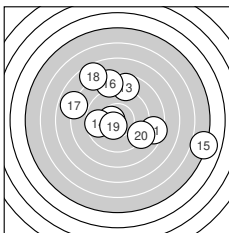

Serie 2:

8.5 →	10.5 *	8.7 ↑	9.7 ←	5.0 →
8.5 ↑	7.9 ←	7.6 ↘	10.5 *	9.1 ↘

beste Teiler: 104.1 (12.), 114.0 (19.), 322.5 (14.)
 Trefferlage: 0.78 mm rechts, 1.16 mm hoch
 Streuwert: 5.10, horizontal: 6.05, vertikal: 3.92



Ergebnis: **613.1** (582)
 Serien: 102.0 102.2 102.5 102.8 102.6 101.0
 Zähler: 42 18 0 0 0 0 0 0 0
 Innenzehner: 35
 Weitester: 413 (12.), 363 (55.), 353 (42.)
 beste Teiler: 29.0 (18.), 37.6 (5.), 42.9 (11.)
 Trefferlage: 0.12 mm rechts, 0.02 mm hoch
 Streuwert: 1.47, horizontal: 1.57, vertikal: 1.36

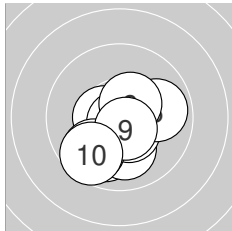
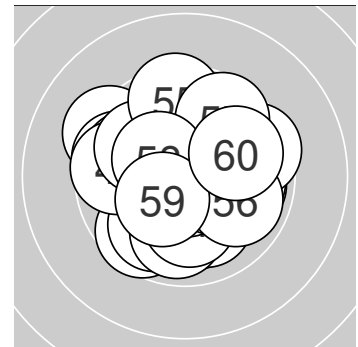

Serie 1:

9.9 ↙	10.0 ↓	10.5 *	10.5 *	10.8 *
9.9 →	9.7 ↙	10.5 *	10.6 *	9.6 ↘

beste Teiler: 37.6 (5.), 93.0 (9.), 112.0 (4.)
 Trefferlage: 0.12 mm links, 1.02 mm tief
 Streuwert: 1.36, horizontal: 1.41, vertikal: 1.31

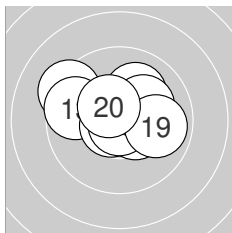

Serie 2:

10.8 *	9.3 ↘	9.6 ↖	10.1 ↗	10.7 *
10.4 *	10.2 *	10.8 *	9.9 →	10.4 *

beste Teiler: 29.0 (18.), 42.9 (11.), 73.2 (15.)
 Trefferlage: 0.12 mm links, 0.52 mm hoch
 Streuwert: 1.57, horizontal: 2.00, vertikal: 0.97

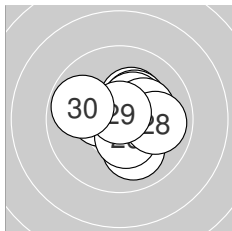

Serie 3:

10.0 ↓	10.4 *	10.3 *	10.3 *	10.4 *
10.4 *	10.2 *	9.9 →	10.8 *	9.8 ↖

beste Teiler: 47.0 (29.), 133.1 (22.), 135.0 (26.)
 Trefferlage: 0.46 mm rechts, 0.25 mm hoch
 Streuwert: 1.33, horizontal: 1.49, vertikal: 1.15

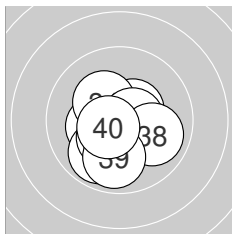

Serie 4:

10.3 *	10.5 *	10.4 *	10.3 *	9.9 ↙
10.6 *	10.4 *	9.9 ↘	9.9 ↓	10.6 *

beste Teiler: 93.1 (36.), 95.7 (40.), 117.2 (32.)
 Trefferlage: 0.19 mm links, 0.73 mm tief
 Streuwert: 1.24, horizontal: 1.26, vertikal: 1.23

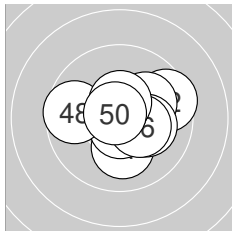

Serie 5:

10.1 ↓	9.5 →	10.1 ↗	10.7 *	10.2 *
10.3 *	10.7 *	9.7 ↖	10.5 *	10.8 *

beste Teiler: 47.3 (50.), 63.6 (47.), 65.2 (44.)
 Trefferlage: 0.50 mm rechts, 0.09 mm hoch
 Streuwert: 1.45, horizontal: 1.77, vertikal: 1.05

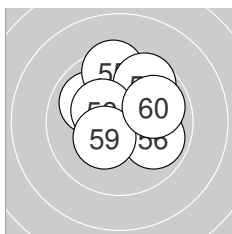

Serie 6:

10.7 *	10.0 ↘	10.5 *	10.1 ↗	9.5 ↑
9.9 ↘	9.7 ↗	10.4 *	10.3 *	9.9 →

beste Teiler: 75.1 (51.), 121.0 (53.), 149.2 (58.)
 Trefferlage: 0.25 mm rechts, 1.03 mm hoch
 Streuwert: 1.56, horizontal: 1.67, vertikal: 1.45



Ergebnis: **362.3** (342)
 Serien: 89.5 85.5 98.9 88.4
 Zähler: 9 15 7 7 2 0 0 0 0 0
 Innenzehner: 4
 Weitester: 1107 (40.), 1087 (31.), 896 (18.)
 beste Teiler: 62.0 (35.), 91.7 (21.), 133.0 (30.)
 Trefferlage: 2.88 mm links, 0.63 mm tief
 Streuwert: 3.26, horizontal: 3.43, vertikal: 3.07

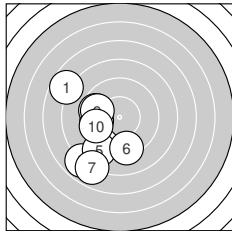
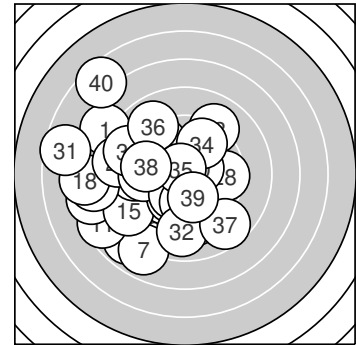

Serie 1:
 7.7 ↖ 9.7 ← 7.9 ↘ 9.2 ↘ 8.9 ↘
 9.3 ↓ 7.9 ↘ 9.6 ← 9.7 ↖ 9.6 ↘
 beste Teiler: 310.2 (2.), 310.7 (9.), 335.5 (8.)
 Trefferlage: 3.24 mm links, 2.05 mm tief
 Streuwert: 2.82, horizontal: 2.03, vertikal: 3.43

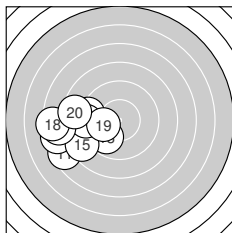

Serie 2:
 7.5 ↖ 9.2 ← 9.8 ↘ 7.5 ← 8.6 ↘
 9.2 ← 7.7 ← 7.4 ← 10.1 ← 8.5 ↖
 beste Teiler: 223.9 (19.), 283.0 (13.), 430.0 (12.)
 Trefferlage: 5.63 mm links, 1.23 mm tief
 Streuwert: 2.19, horizontal: 2.55, vertikal: 1.75

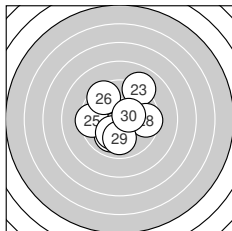

Serie 3:
 10.6 * 10.3 * 9.0 ↗ 10.0 ↘ 9.5 ←
 9.5 ↘ 10.1 ↘ 9.5 → 10.0 ↓ 10.4 *
 beste Teiler: 91.7 (21.), 133.0 (30.), 160.1 (22.)
 Trefferlage: 0.21 mm links, 0.12 mm tief
 Streuwert: 2.14, horizontal: 2.15, vertikal: 2.13

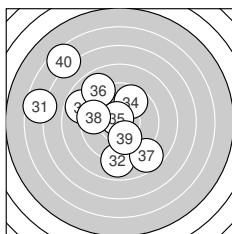

Serie 4:
 6.6 ← 8.9 ↓ 8.8 ↖ 9.7 ↗ 10.7 *
 8.9 ↘ 8.7 ↘ 9.5 ← 10.1 ↓ 6.5 ↘
 beste Teiler: 62.0 (35.), 218.8 (39.), 311.9 (34.)
 Trefferlage: 2.43 mm links, 0.89 mm hoch
 Streuwert: 4.18, horizontal: 4.36, vertikal: 4.00



Ergebnis: **400.6** (385)
 Serien: 100.3 96.7 101.8 101.8
 Zähler: 26 13 1 0 0 0 0 0 0 0
 Innenzehner: 21
 Weitester: 704 (13.), 487 (16.), 465 (12.)
 beste Teiler: 37.3 (40.), 83.0 (14.), 93.6 (22.)
 Trefferlage: 0.68 mm links, 0.27 mm hoch
 Streuwert: 1.86, horizontal: 2.05, vertikal: 1.65

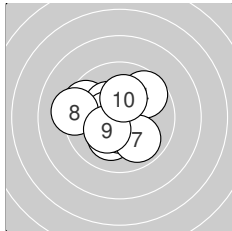
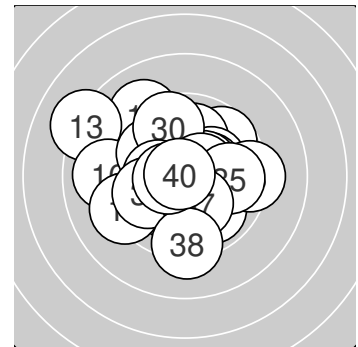

Serie 1:

9.6 ↖	10.3 *	10.5 *	9.7 ↗	10.1 ↘
10.5 *	9.9 ↘	9.2 ←	10.3 *	10.2 *

beste Teiler: 116.0 (6.), 116.7 (3.), 159.8 (2.)
 Trefferlage: 0.74 mm links, 0.09 mm hoch
 Streuwert: 1.78, horizontal: 1.99, vertikal: 1.54

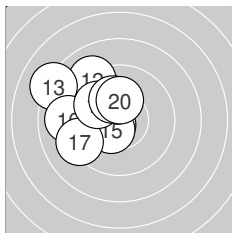

Serie 2:

10.0 ↘	9.1 ↘	8.1 ↖	10.6 *	10.5 *
9.0 ←	9.2 ↙	9.9 ↘	10.1 ↗	10.2 *

beste Teiler: 83.0 (14.), 121.1 (15.), 190.0 (20.)
 Trefferlage: 2.27 mm links, 1.11 mm hoch
 Streuwert: 1.99, horizontal: 2.09, vertikal: 1.88

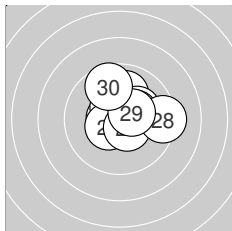

Serie 3:

10.0 ↑	10.6 *	10.4 *	10.2 *	10.3 *
10.5 *	10.5 *	9.3 →	10.4 *	9.6 ↗

beste Teiler: 93.6 (22.), 106.2 (27.), 125.0 (26.)
 Trefferlage: 0.60 mm rechts, 0.72 mm hoch
 Streuwert: 1.44, horizontal: 1.62, vertikal: 1.24

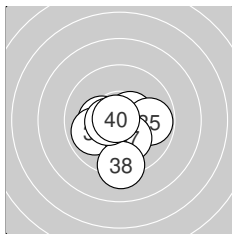

Serie 4:

10.1 ↙	10.5 *	10.5 *	10.3 *	9.8 →
9.9 ↙	10.2 *	9.2 ↓	10.5 *	10.8 *

beste Teiler: 37.3 (40.), 108.0 (39.), 110.4 (33.)
 Trefferlage: 0.33 mm links, 0.84 mm tief
 Streuwert: 1.48, horizontal: 1.57, vertikal: 1.37



Ergebnis: **402.6** (385)
 Serien: 99.3 101.1 101.0 101.2
 Zähler: 26 13 1 0 0 0 0 0 0 0
 Innenzehner: 19
 Weitestе: 647 (6.), 461 (30.), 449 (18.)
 beste Teiler: 52.3 (8.), 59.0 (28.), 69.6 (4.)
 Trefferlage: 0.30 mm rechts, 0.28 mm hoch
 Streuwert: 1.83, horizontal: 2.33, vertikal: 1.12

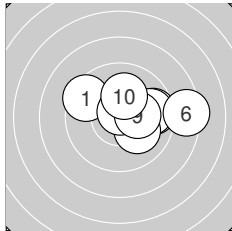
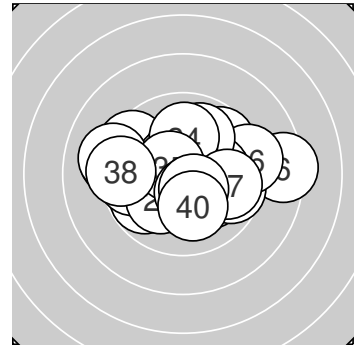

Serie 1:

9.5 ↘	9.6 →	10.1 →	10.7 *	9.8 →
8.4 →	10.1 ↘	10.7 *	10.3 *	10.1 ↑

beste Teiler: 52.3 (8.), 69.6 (4.), 175.1 (9.)
 Trefferlage: 1.54 mm rechts, 0.60 mm hoch
 Streuwert: 1.90, horizontal: 2.53, vertikal: 0.90

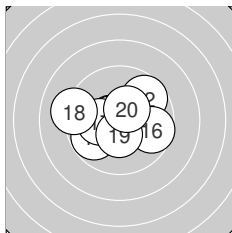

Serie 2:

10.6 *	9.7 ↗	9.8 ↙	10.4 *	10.7 *
9.7 →	10.2 *	9.2 ←	10.4 *	10.4 *

beste Teiler: 75.9 (15.), 81.2 (11.), 127.8 (20.)
 Trefferlage: 0.28 mm links, 0.01 mm tief
 Streuwert: 1.81, horizontal: 2.29, vertikal: 1.14

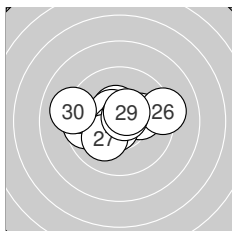

Serie 3:

10.4 *	9.7 ←	10.2 *	10.5 *	10.6 *
9.2 →	10.1 ↙	10.7 *	10.5 *	9.1 ←

beste Teiler: 59.0 (28.), 78.8 (25.), 109.7 (24.)
 Trefferlage: 0.34 mm links, 0.30 mm hoch
 Streuwert: 1.86, horizontal: 2.46, vertikal: 0.91

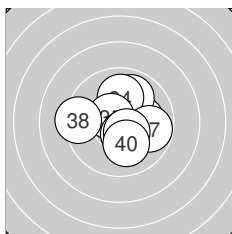

Serie 4:

10.1 →	9.9 ↗	10.3 *	10.0 ↑	10.6 *
10.5 *	9.8 →	9.4 ←	10.5 *	10.1 ↓

beste Teiler: 98.7 (35.), 118.2 (39.), 122.7 (36.)
 Trefferlage: 0.28 mm rechts, 0.24 mm hoch
 Streuwert: 1.67, horizontal: 1.83, vertikal: 1.50



Ergebnis: **385.0** (369)
 Serien: 96.7 96.1 98.0 94.2
 Zähler: 18 15 5 2 0 0 0 0 0 0
 Innenzehner: 10
 Weitester: 797 (29.), 754 (35.), 630 (19.)
 beste Teiler: 82.2 (24.), 92.6 (2.), 124.7 (27.)
 Trefferlage: 0.07 mm links, 1.31 mm tief
 Streuwert: 2.55, horizontal: 3.04, vertikal: 1.93

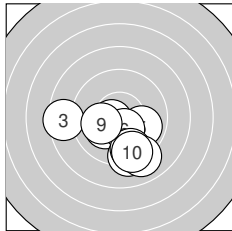
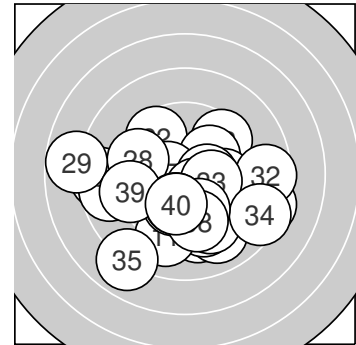

Serie 1:

10.2 *	10.6 *	8.5 ←	9.2 ↓	9.9 →
10.4 *	9.5 ↓	9.0 ↓	10.1 ←	9.3 ↓

beste Teiler: 92.6 (2.), 139.2 (6.), 198.2 (1.)
 Trefferlage: 0.17 mm links, 2.05 mm tief
 Streuwert: 2.18, horizontal: 2.59, vertikal: 1.67

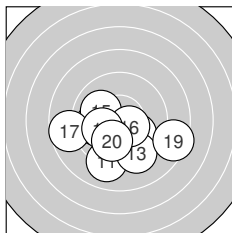

Serie 2:

9.1 ↓	10.0 ↘	9.4 ↓	9.9 ←	10.0 ↘
10.5 *	8.7 ←	10.1 ←	8.4 →	10.0 ↓

beste Teiler: 125.0 (16.), 210.2 (18.), 229.4 (15.)
 Trefferlage: 0.37 mm links, 1.62 mm tief
 Streuwert: 2.49, horizontal: 3.15, vertikal: 1.59

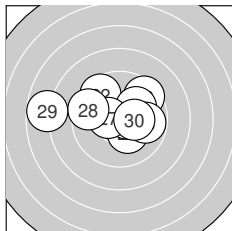

Serie 3:

10.3 *	9.6 ↘	9.5 ↗	10.6 *	10.1 ↗
9.8 →	10.5 *	9.5 ←	7.8 ←	10.3 *

beste Teiler: 82.2 (24.), 124.7 (27.), 161.1 (30.)
 Trefferlage: 0.41 mm links, 0.67 mm hoch
 Streuwert: 2.54, horizontal: 3.35, vertikal: 1.29

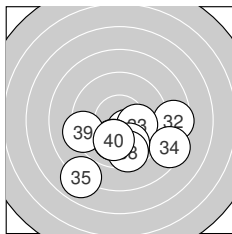

Serie 4:

10.4 *	8.6 →	10.2 *	8.5 ↘	7.9 ↘
10.0 ↓	9.8 ↓	9.5 ↓	9.3 ←	10.0 ↓

beste Teiler: 133.0 (31.), 198.4 (33.), 226.7 (36.)
 Trefferlage: 0.64 mm rechts, 2.24 mm tief
 Streuwert: 2.69, horizontal: 3.36, vertikal: 1.77



Ergebnis: **388.6** (370)
 Serien: 99.6 95.7 98.1 95.2
 Zähler: 14 22 4 0 0 0 0 0 0 0
 Innenzehner: 12
 Weitester: 666 (27.), 611 (40.), 548 (38.)
 beste Teiler: 18.7 (16.), 56.0 (1.), 92.1 (23.)
 Trefferlage: 0.03 mm links, 0.92 mm hoch
 Streuwert: 2.39, horizontal: 2.74, vertikal: 1.99

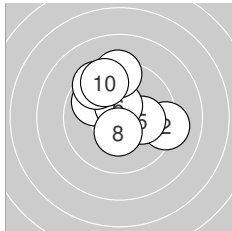
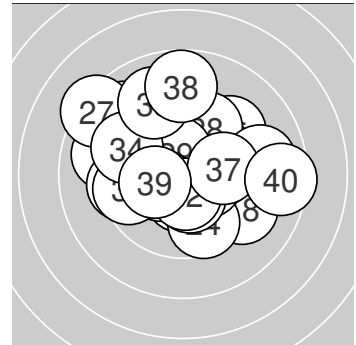

Serie 1:

10.7 *	9.2 →	10.5 *	9.9 ↖	10.1 →
10.5 *	9.3 ↑	10.4 *	9.5 ↘	9.5 ↖

beste Teiler: 56.0 (1.), 109.4 (6.), 114.0 (3.)
 Trefferlage: 0.06 mm rechts, 0.95 mm hoch
 Streuwert: 1.96, horizontal: 1.97, vertikal: 1.94

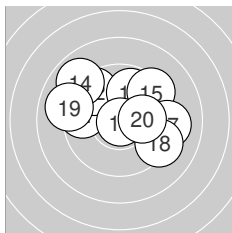

Serie 2:

9.6 ←	9.5 ↘	9.8 ↑	8.9 ↘	9.4 ↗
10.9 *	9.2 →	9.3 ↘	9.0 ←	10.1 →

beste Teiler: 18.7 (16.), 212.2 (20.), 279.2 (13.)
 Trefferlage: 0.00 mm , 1.06 mm hoch
 Streuwert: 2.69, horizontal: 3.35, vertikal: 1.78

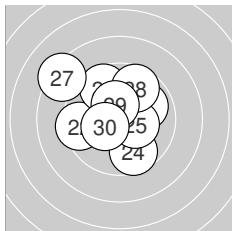

Serie 3:

9.9 ↗	9.4 ←	10.6 *	9.6 ↘	10.3 *
9.6 ↘	8.3 ↘	9.7 ↗	10.4 *	10.3 *

beste Teiler: 92.1 (23.), 141.3 (29.), 153.3 (30.)
 Trefferlage: 0.55 mm links, 0.82 mm hoch
 Streuwert: 2.30, horizontal: 2.49, vertikal: 2.10

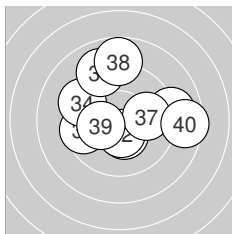

Serie 4:

10.4 *	10.4 *	9.6 ←	9.4 ↖	9.0 ↖
9.0 →	9.9 →	8.8 ↑	10.2 *	8.5 →

beste Teiler: 126.1 (32.), 148.6 (31.), 182.0 (39.)
 Trefferlage: 0.35 mm rechts, 0.83 mm hoch
 Streuwert: 2.86, horizontal: 3.26, vertikal: 2.38



Ergebnis: **401.0** (383)
 Serien: 101.7 99.7 101.0 98.6
 Zähler: 26 12 1 1 0 0 0 0 0 0
 Innenzehner: 21
 Weitestе: 862 (40.), 513 (18.), 490 (34.)
 beste Teiler: 22.8 (9.), 30.8 (30.), 45.0 (22.)
 Trefferlage: 0.86 mm rechts, 0.09 mm tief
 Streuwert: 1.95, horizontal: 2.44, vertikal: 1.30

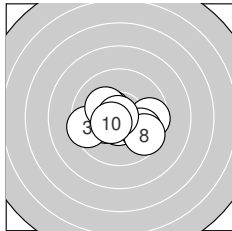
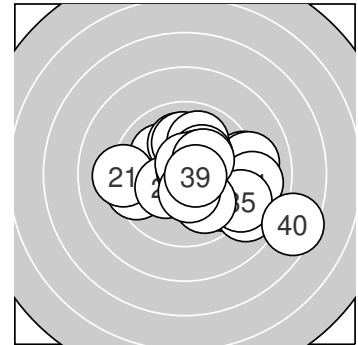

Serie 1:

10.6 *	10.3 *	9.5 ←	9.7 →	10.5 *
10.2 *	9.9 ↘	9.6 ↘	10.9 *	10.5 *

beste Teiler: 22.8 (9.), 82.8 (1.), 109.0 (10.)
 Trefferlage: 0.05 mm links, 0.44 mm tief
 Streuwert: 1.64, horizontal: 2.15, vertikal: 0.89

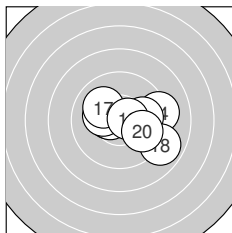

Serie 2:

10.5 *	9.9 →	10.5 *	9.2 →	9.9 →
10.2 *	10.1 ↖	8.9 ↘	10.6 *	9.9 ↘

beste Teiler: 91.2 (19.), 101.8 (13.), 124.7 (11.)
 Trefferlage: 1.12 mm rechts, 0.04 mm tief
 Streuwert: 1.89, horizontal: 2.43, vertikal: 1.13

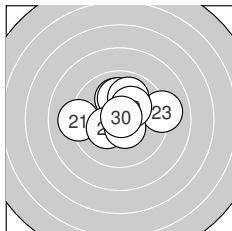

Serie 3:

9.2 ←	10.8 *	9.1 →	10.1 ↑	10.0 ↑
10.3 *	10.0 ↗	10.5 *	10.2 *	10.8 *

beste Teiler: 30.8 (30.), 45.0 (22.), 109.2 (28.)
 Trefferlage: 0.10 mm rechts, 0.76 mm hoch
 Streuwert: 1.82, horizontal: 2.25, vertikal: 1.25

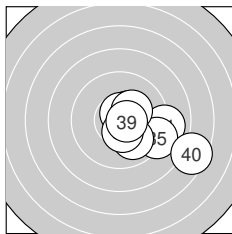

Serie 4:

10.5 *	10.7 *	10.4 *	9.0 →	9.2 ↘
10.3 *	10.0 ↘	10.4 *	10.6 *	7.5 ↘

beste Teiler: 75.5 (32.), 78.0 (39.), 125.9 (31.)
 Trefferlage: 2.27 mm rechts, 0.64 mm tief
 Streuwert: 2.08, horizontal: 2.50, vertikal: 1.55



Ergebnis: **388.4** (371)
 Serien: 98.8 99.2 96.7 93.7
 Zähler: 14 23 3 0 0 0 0 0 0 0
 Innenzehner: 8
 Weitester: 708 (37.), 645 (21.), 586 (33.)
 beste Teiler: 32.2 (8.), 60.0 (39.), 79.7 (12.)
 Trefferlage: 0.53 mm links, 0.35 mm tief
 Streuwert: 2.43, horizontal: 2.79, vertikal: 2.00

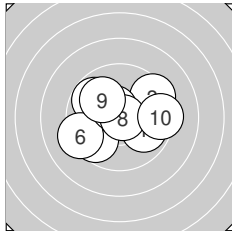
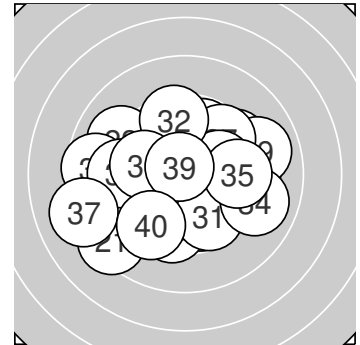

Serie 1:

9.9 ↘ 9.7 ↙ 9.4 ↗
 9.3 ↖ 10.5 * 10.8 *

10.1 ↖ 9.8 ↖
 10.0 ↘ 9.3 →

beste Teiler: 32.2 (8.), 101.3 (7.), 208.8 (4.)
 Trefferlage: 0.27 mm links, 0.20 mm hoch
 Streuwert: 2.17, horizontal: 2.68, vertikal: 1.51

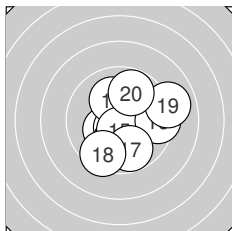

Serie 2:

10.3 * 10.6 * 10.1 ↖
 9.4 → 9.8 ↓ 9.5 ↙

10.1 ↓ 10.6 *
 9.0 → 9.8 ↗

beste Teiler: 79.7 (12.), 96.0 (15.), 164.4 (11.)
 Trefferlage: 0.61 mm rechts, 0.45 mm tief
 Streuwert: 2.06, horizontal: 2.12, vertikal: 2.00

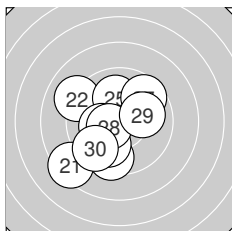

Serie 3:

8.4 ↙ 9.1 ↖ 9.5 ↓
 10.2 * 9.6 ↗ 10.5 *

9.9 ↙ 10.0 ↑
 10.0 → 9.5 ↙

beste Teiler: 114.9 (28.), 184.2 (26.), 230.6 (25.)
 Trefferlage: 1.19 mm links, 0.64 mm tief
 Streuwert: 2.41, horizontal: 2.33, vertikal: 2.49

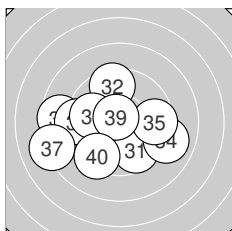

Serie 4:

9.7 ↓ 9.5 ↑ 8.6 ←
 9.3 ← 8.1 ← 9.9 ←

9.0 ↘ 9.6 →
 10.7 * 9.3 ↙

beste Teiler: 60.0 (39.), 273.8 (38.), 317.6 (31.)
 Trefferlage: 1.30 mm links, 0.52 mm tief
 Streuwert: 3.03, horizontal: 3.75, vertikal: 2.08



Ergebnis: **365.7** (348)
 Serien: 87.4 95.8 92.3 90.2
 Zähler: 8 17 10 5 0 0 0 0 0 0
 Innenzehner: 6
 Weitester: 986 (1.), 985 (2.), 873 (38.)
 beste Teiler: 118.9 (39.), 134.0 (16.), 136.0 (11.)
 Trefferlage: 0.46 mm links, 1.70 mm tief
 Streuwert: 3.37, horizontal: 3.63, vertikal: 3.08

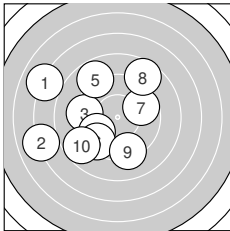
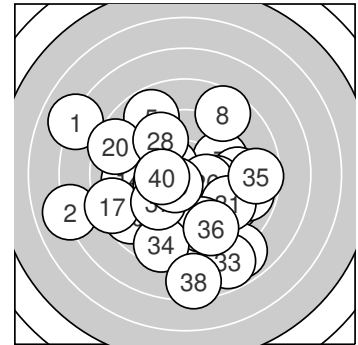

Serie 1:

7.0 ↖	7.0 ←	9.3 ←	9.7 ↙	8.8 ↘
9.4 ↗	9.7 →	8.6 ↗	9.2 ↓	8.7 ↘

beste Teiler: 309.9 (4.), 313.0 (7.), 388.7 (6.)
 Trefferlage: 2.72 mm links, 0.01 mm hoch
 Streuwert: 3.97, horizontal: 4.31, vertikal: 3.59

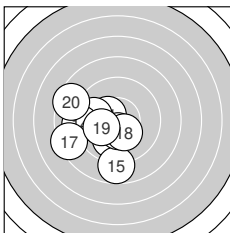

Serie 2:

10.4 *	9.8 ←	10.0 ↓	9.1 ←	8.8 ↓
10.4 *	8.4 ←	10.3 *	10.1 ←	8.5 ←

beste Teiler: 134.0 (16.), 136.0 (11.), 167.7 (18.)
 Trefferlage: 2.23 mm links, 1.11 mm tief
 Streuwert: 2.28, horizontal: 2.43, vertikal: 2.13

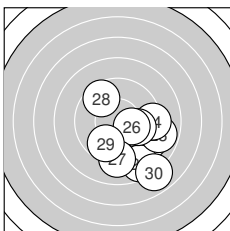

Serie 3:

9.2 ↘	8.6 ↓	8.9 →	9.2 →	9.9 →
10.2 *	9.1 ↓	9.6 ↘	9.7 ↙	7.9 ↓

beste Teiler: 183.5 (26.), 256.6 (25.), 306.4 (29.)
 Trefferlage: 2.09 mm rechts, 2.13 mm tief
 Streuwert: 2.60, horizontal: 2.50, vertikal: 2.70

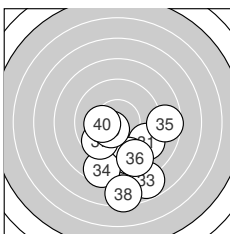

Serie 4:

9.2 ↘	9.2 ↓	7.8 ↓	8.5 ↓	8.6 →
9.0 ↓	9.7 ↙	7.5 ↓	10.5 *	10.2 *

beste Teiler: 118.9 (39.), 189.2 (40.), 314.0 (37.)
 Trefferlage: 1.02 mm rechts, 3.59 mm tief
 Streuwert: 2.83, horizontal: 2.73, vertikal: 2.93



Ergebnis: **387.8** (369)
 Serien: 93.9 96.4 99.0 98.5
 Zähler: 14 21 5 0 0 0 0 0 0 0
 Innenzehner: 8
 Weitester: 743 (5.), 699 (12.), 694 (4.)
 beste Teiler: 32.6 (23.), 55.3 (14.), 59.5 (19.)
 Trefferlage: 0.54 mm rechts, 0.04 mm hoch
 Streuwert: 2.55, horizontal: 3.16, vertikal: 1.72

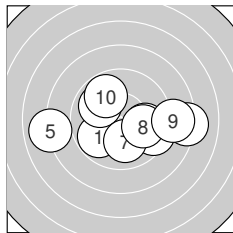
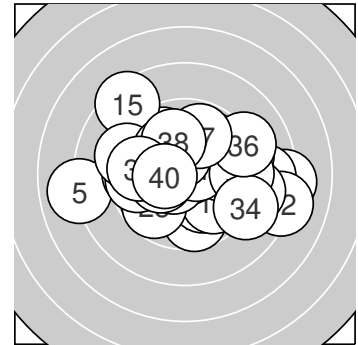

Serie 1:
 9.8 ↙ 9.9 → 9.5 →
 9.9 ↘ 10.0 ↓ 10.0 →
 beste Teiler: 231.8 (7.), 246.3 (8.), 256.0 (6.)
 Trefferlage: 0.79 mm rechts, 0.49 mm tief
 Streuwert: 3.16, horizontal: 4.24, vertikal: 1.43

8.2 → 8.0 ←
 8.8 → 9.8 ↘

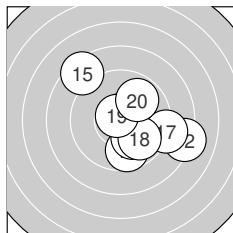

Serie 2:
 9.7 ↓ 8.2 → 10.1 ↘ 10.7 * 8.4 ↘
 9.8 ↘ 9.0 → 9.9 ↘ 10.7 * 9.9 ↗
 beste Teiler: 55.3 (14.), 59.5 (19.), 221.8 (13.)
 Trefferlage: 1.50 mm rechts, 0.35 mm tief
 Streuwert: 2.66, horizontal: 2.89, vertikal: 2.41

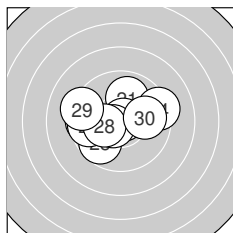

Serie 3:
 10.0 ↑ 9.5 ← 10.8 * 9.3 → 9.7 ↙
 9.6 ← 10.6 * 10.3 * 9.3 ← 9.9 →
 beste Teiler: 32.6 (23.), 94.3 (27.), 173.9 (28.)
 Trefferlage: 0.79 mm links, 0.18 mm hoch
 Streuwert: 2.09, horizontal: 2.66, vertikal: 1.27

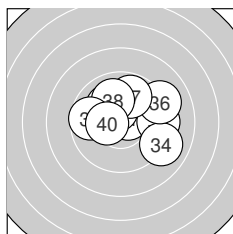

Serie 4:
 10.6 * 9.4 → 10.4 * 9.0 ↘ 10.1 ↘
 9.1 ↗ 9.8 ↑ 10.0 ↘ 9.7 ← 10.4 *
 beste Teiler: 85.9 (31.), 131.2 (33.), 141.6 (40.)
 Trefferlage: 0.68 mm rechts, 0.82 mm hoch
 Streuwert: 2.13, horizontal: 2.62, vertikal: 1.48



Ergebnis: **369.1** (347)
Serien: 88.7 94.8 89.6 96.0
Zähler: 8 18 7 7 0 0 0 0 0 0
Innenzehner: 5
Weiteste: 867 (20.), 833 (2.), 821 (36.)
beste Teiler: 41.4 (23.), 87.0 (14.), 106.0 (15.)
Trefferlage: 0.81 mm links, 1.31 mm hoch
Streuwert: 3.30, horizontal: 3.86, vertikal: 2.62

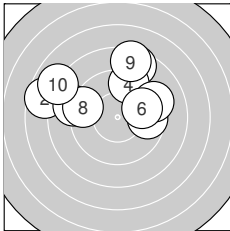
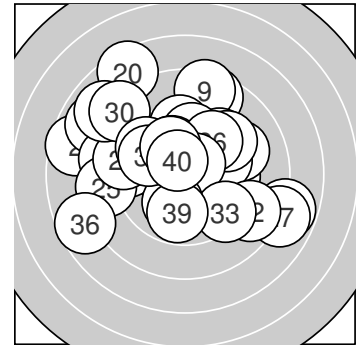

Serie 1:

9.6 →	7.6 ←	8.5 ↑	9.4 ↑	9.2 →
9.8 →	8.9 ←	9.4 ←	8.4 ↑	7.9 ↖

beste Teiler: 288.8 (6.), 331.3 (1.), 395.6 (4.)
Trefferlage: 0.86 mm links, 2.64 mm hoch
Streuwert: 3.51, horizontal: 4.50, vertikal: 2.11

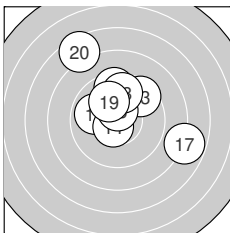

Serie 2:

9.8 ↑	9.9 ←	9.5 ↗	10.6 *	10.5 *
9.5 ↑	7.8 →	9.7 ↑	10.0 ↘	7.5 ↘

beste Teiler: 87.0 (14.), 106.0 (15.), 226.8 (19.)
Trefferlage: 0.29 mm rechts, 1.99 mm hoch
Streuwert: 2.92, horizontal: 3.12, vertikal: 2.72

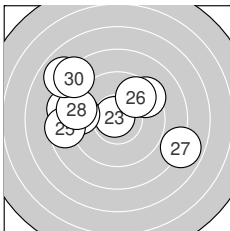

Serie 3:

8.7 ←	9.4 ↗	10.8 *	9.2 ←	8.6 ←
9.7 ↗	7.9 →	9.1 ←	7.9 ↖	8.3 ↖

beste Teiler: 41.4 (23.), 316.1 (26.), 393.1 (22.)
Trefferlage: 1.92 mm links, 1.31 mm hoch
Streuwert: 3.64, horizontal: 4.57, vertikal: 2.38

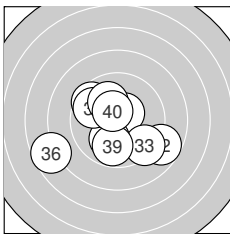

Serie 4:

10.5 *	8.7 →	9.3 ↘	9.6 ↖	10.1 ↓
7.7 ←	9.8 ←	10.0 ↘	9.8 ↓	10.5 *

beste Teiler: 107.5 (31.), 114.6 (40.), 225.6 (35.)
Trefferlage: 0.75 mm links, 0.68 mm tief
Streuwert: 2.85, horizontal: 3.32, vertikal: 2.29



Ergebnis: **183.4** (175)
Serien: 91.6 91.8
Zähler: 4 10 4 1 1 0 0 0 0 0
Innenzehner: 2
Weiteste: 1074 (17.), 878 (8.), 729 (13.)
beste Teiler: 39.0 (16.), 192.0 (6.), 211.6 (19.)
Trefferlage: 1.45 mm links, 0.65 mm hoch
Streuwert: 3.49, horizontal: 4.05, vertikal: 2.83

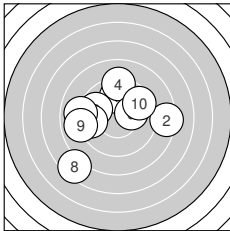
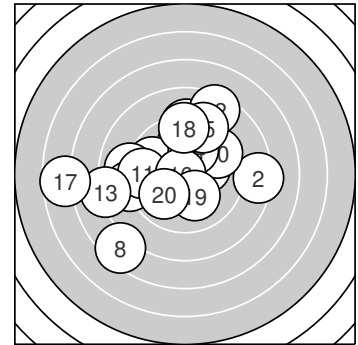

Serie 1:

9.8 ↑	8.3 →	9.7 ↖	9.2 ↑	9.5 ←
10.2 *	9.0 ←	7.4 ↙	8.9 ←	9.6 ↗

beste Teiler: 192.0 (6.), 279.7 (1.), 312.6 (3.)
Trefferlage: 1.09 mm links, 0.27 mm hoch
Streuwert: 3.53, horizontal: 4.04, vertikal: 2.94

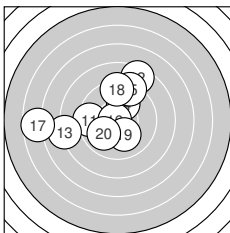

Serie 2:

9.4 ←	8.4 ↗	8.0 ←	10.0 ↑	9.2 ↑
10.8 *	6.7 ←	9.3 ↑	10.1 ↓	9.9 ↙

beste Teiler: 39.0 (16.), 211.6 (19.), 230.5 (14.)
Trefferlage: 1.80 mm links, 1.03 mm hoch
Streuwert: 3.60, horizontal: 4.24, vertikal: 2.81



Ergebnis: **198.4** (192)
 Serien: 100.4 98.0
 Zähler: 12 8 0 0 0 0 0 0 0 0
 Innenzehner: 7
 Weitester: 482 (10.), 448 (5.), 432 (13.)
 beste Teiler: 14.3 (9.), 106.5 (3.), 122.0 (7.)
 Trefferlage: 0.81 mm links, 0.13 mm hoch
 Streuwert: 2.01, horizontal: 2.34, vertikal: 1.62

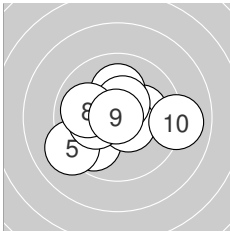
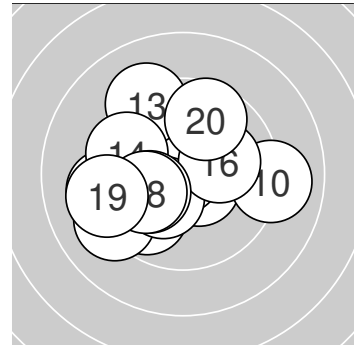

Serie 1:

9.8 ↙	10.2 *	10.5 *	10.1 ↑	9.2 ↙
10.2 *	10.5 *	10.0 ←	10.9 *	9.0 →

beste Teiler: 14.3 (9.), 106.5 (3.), 122.0 (7.)
 Trefferlage: 0.20 mm links, 0.16 mm tief
 Streuwert: 2.00, horizontal: 2.45, vertikal: 1.40

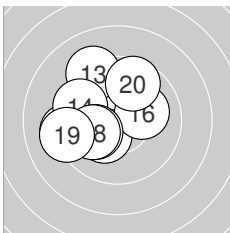

Serie 2:

9.3 ←	10.4 *	9.2 ↘	9.6 ↖	10.3 *
10.1 →	10.1 ↙	10.1 ↙	9.2 ↖	9.7 ↗

beste Teiler: 139.8 (12.), 166.8 (15.), 206.2 (17.)
 Trefferlage: 1.41 mm links, 0.44 mm hoch
 Streuwert: 2.01, horizontal: 2.18, vertikal: 1.84



Ergebnis: **192.8** (184)
 Serien: 95.4 97.4
 Zähler: 8 8 4 0 0 0 0 0 0 0
 Innenzehner: 6
 Weitester: 731 (8.), 613 (3.), 596 (17.)
 beste Teiler: 101.1 (9.), 112.0 (14.), 126.4 (19.)
 Trefferlage: 0.11 mm rechts, 0.73 mm tief
 Streuwert: 2.69, horizontal: 3.02, vertikal: 2.31

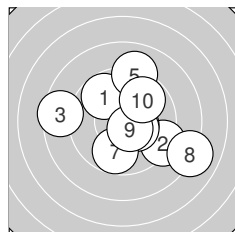
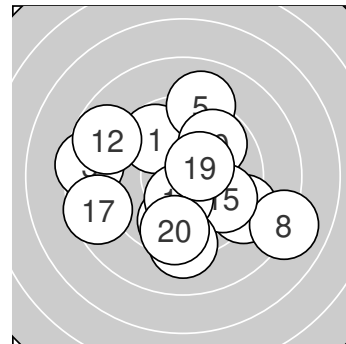

Serie 1:

9.7 ↘	9.2 ↘	8.5 ←	10.4 *	9.1 ↑
10.4 *	9.8 ↓	8.0 ↘	10.5 *	9.8 ↗

beste Teiler: 101.1 (9.), 136.6 (4.), 149.0 (6.)
 Trefferlage: 0.83 mm rechts, 0.01 mm tief
 Streuwert: 2.96, horizontal: 3.37, vertikal: 2.50

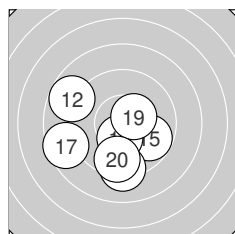

Serie 2:

10.1 ↓	8.8 ↘	10.1 ↓	10.5 *	9.8 ↘
9.2 ↓	8.6 ←	10.4 *	10.4 *	9.5 ↓

beste Teiler: 112.0 (14.), 126.4 (19.), 148.4 (18.)
 Trefferlage: 0.60 mm links, 1.46 mm tief
 Streuwert: 2.31, horizontal: 2.61, vertikal: 1.96



Ergebnis: **179.5** (171)
 Serien: 97.0 82.5
 Zähler: 4 9 4 1 1 1 0 0 0 0
 Innenzehner: 3
 Weitestе: 1344 (15.), 1031 (13.), 884 (17.)
 beste Teiler: 162.8 (8.), 187.8 (2.), 198.4 (6.)
 Trefferlage: 2.14 mm rechts, 1.10 mm hoch
 Streuwert: 3.84, horizontal: 5.07, vertikal: 1.95

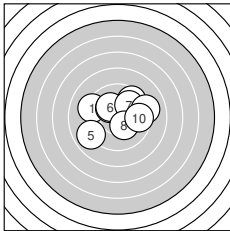
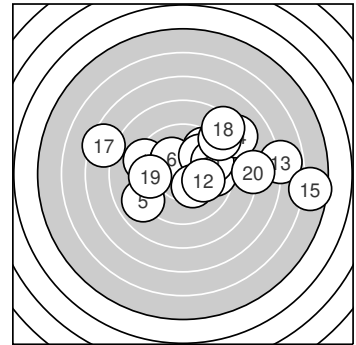

Serie 1:

9.2 ↖	10.2 *	9.9 →	9.6 ↗	9.0 ↙
10.2 *	9.9 ↗	10.3 *	9.1 →	9.6 →

beste Teiler: 162.8 (8.), 187.8 (2.), 198.4 (6.)
 Trefferlage: 0.47 mm rechts, 0.61 mm hoch
 Streuwert: 2.41, horizontal: 2.99, vertikal: 1.65

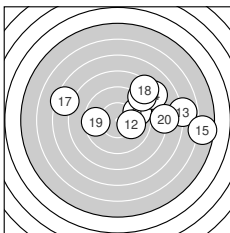

Serie 2:

9.6 ↗	10.1 →	6.8 →	8.2 ↗	5.6 →
8.8 ↗	7.4 ↖	8.4 ↗	9.6 ←	8.0 →

beste Teiler: 223.6 (12.), 336.4 (11.), 345.9 (19.)
 Trefferlage: 3.80 mm rechts, 1.58 mm hoch
 Streuwert: 4.68, horizontal: 6.25, vertikal: 2.19



Ergebnis: **202.4** (194)
 Serien: 102.6 99.8
 Zähler: 15 4 1 0 0 0 0 0 0 0
 Innenzehner: 14
 Weitesten: 568 (19.), 495 (13.), 426 (17.)
 beste Teiler: 83.6 (15.), 87.2 (14.), 88.1 (1.)
 Trefferlage: 0.04 mm links, 0.12 mm hoch
 Streuwert: 1.80, horizontal: 2.38, vertikal: 0.92

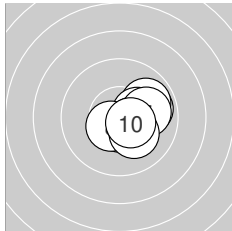
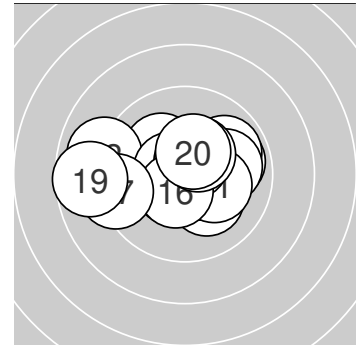

Serie 1:

10.6 *	9.9 →	10.2 *	9.9 ↗	10.3 *
10.5 *	10.0 →	10.5 *	10.2 *	10.5 *

beste Teiler: 88.1 (1.), 110.9 (10.), 111.7 (8.)
 Trefferlage: 1.32 mm rechts, 0.07 mm tief
 Streuwert: 0.97, horizontal: 1.08, vertikal: 0.86

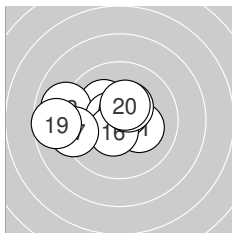

Serie 2:

10.2 *	10.2 *	9.0 ←	10.6 *	10.6 *
10.5 *	9.2 ←	10.4 *	8.7 ←	10.4 *

beste Teiler: 83.6 (15.), 87.2 (14.), 112.0 (16.)
 Trefferlage: 1.40 mm links, 0.31 mm hoch
 Streuwert: 1.95, horizontal: 2.58, vertikal: 0.98



Ergebnis: **200.3** (190)
 Serien: 99.3 101.0
 Zähler: 12 6 2 0 0 0 0 0 0 0
 Innenzehner: 10
 Weitesten: 635 (6.), 528 (3.), 419 (17.)
 beste Teiler: 57.8 (1.), 62.2 (10.), 80.4 (18.)
 Trefferlage: 0.06 mm links, 0.65 mm tief
 Streuwert: 1.97, horizontal: 2.52, vertikal: 1.18

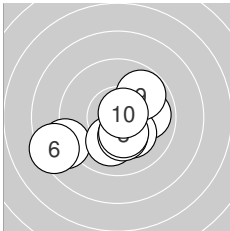
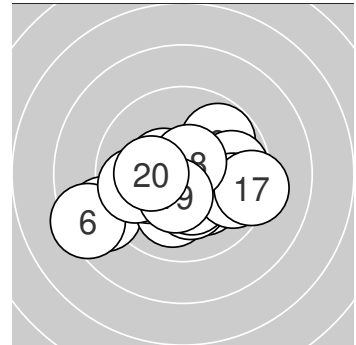

Serie 1:

10.7 *	9.9 →	8.8 ←
8.4 ←	10.3 *	10.4 *

beste Teiler: 57.8 (1.), 62.2 (10.), 149.1 (8.)
 Trefferlage: 0.30 mm links, 0.94 mm tief
 Streuwert: 2.21, horizontal: 2.74, vertikal: 1.50

10.1 ↓	10.2 *
9.8 ↗	10.7 *

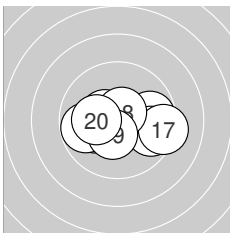

Serie 2:

9.8 →	10.1 ←	10.6 *
9.8 ←	9.3 →	10.6 *

beste Teiler: 80.4 (18.), 92.9 (13.), 125.3 (15.)
 Trefferlage: 0.18 mm rechts, 0.37 mm tief
 Streuwert: 1.77, horizontal: 2.39, vertikal: 0.71

9.7 →	10.5 *
10.4 *	10.2 *



Ergebnis: **184.0** (177)
 Serien: 85.8 98.2
 Zähler: 6 8 4 1 1 0 0 0 0 0
 Innenzehner: 5
 Weitester: 1068 (3.), 802 (8.), 744 (2.)
 beste Teiler: 133.3 (16.), 159.6 (19.), 160.1 (14.)
 Trefferlage: 1.99 mm rechts, 1.28 mm hoch
 Streuwert: 3.21, horizontal: 3.82, vertikal: 2.44

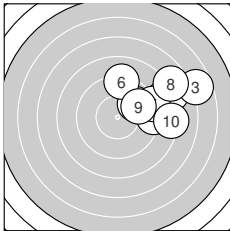
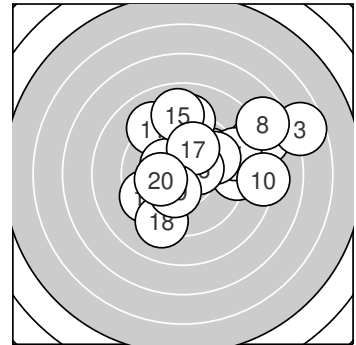

Serie 1:

8.4 ↗	8.0 ↗	6.7 ↗	9.1 →	9.8 ↗
9.1 ↑	9.0 ↗	7.7 ↗	9.8 ↗	8.2 →

beste Teiler: 278.8 (5.), 300.5 (9.), 457.7 (6.)
 Trefferlage: 5.08 mm rechts, 2.25 mm hoch
 Streuwert: 2.30, horizontal: 2.78, vertikal: 1.71

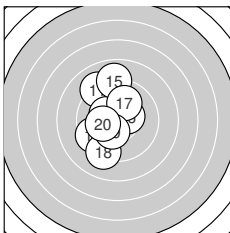

Serie 2:

9.1 ↘	9.5 ↖	10.3 *	10.3 *	8.9 ↑
10.4 *	10.0 ↑	9.2 ↙	10.3 *	10.2 *

beste Teiler: 133.3 (16.), 159.6 (19.), 160.1 (14.)
 Trefferlage: 1.10 mm links, 0.32 mm hoch
 Streuwert: 2.19, horizontal: 1.39, vertikal: 2.76



Ergebnis: **172.8** (163)
 Serien: 85.5 87.3
 Zähler: 1 5 11 2 1 0 0 0 0 0
 Innenzehner: 1
 Weitester: 1089 (16.), 820 (5.), 795 (13.)
 beste Teiler: 133.0 (20.), 276.1 (10.), 301.1 (18.)
 Trefferlage: 1.14 mm links, 3.14 mm hoch
 Streuwert: 3.73, horizontal: 4.50, vertikal: 2.76

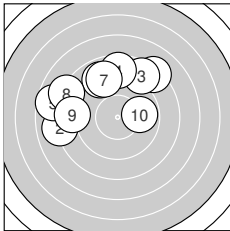
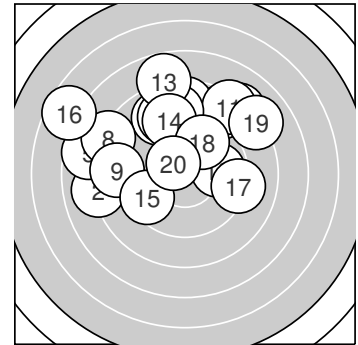

Serie 1:

8.2 ↗	8.0 ←	8.6 ↗	8.6 ↑	7.7 ←
8.9 ↘	8.9 ↖	8.1 ↖	8.7 ←	9.8 →

beste Teiler: 276.1 (10.), 504.1 (7.), 515.3 (6.)
 Trefferlage: 2.08 mm links, 2.98 mm hoch
 Streuwert: 3.70, horizontal: 4.58, vertikal: 2.54

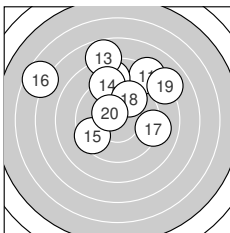

Serie 2:

8.3 ↗	8.8 ↑	7.8 ↑	9.1 ↑	9.5 ↖
6.6 ↖	9.1 →	9.7 ↗	8.0 ↗	10.4 *

beste Teiler: 133.0 (20.), 301.1 (18.), 368.5 (15.)
 Trefferlage: 0.20 mm links, 3.29 mm hoch
 Streuwert: 3.83, horizontal: 4.45, vertikal: 3.09

