

Ergebnis: **188** (197.4)
 Serien: 43 50 48 47
 Zähler: 11 6 3 0 0 0 0 0 0 0
 Innenzehner: 9
 weiteste: 748 (4), 505 (2), 503 (12)
 beste Teiler 49.0 (8.) 89.6 (13.) 110.0 (10.)
 Trefferlage 0.78 mm rechts, 0.44 mm hoch
 Streuwert 2.22, horizontal: 2.56, vertikal: 1.82

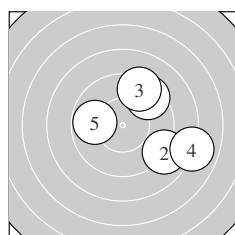

Serie 1:
 9.4 ↗ 8.9 ↘ 9.3 ↗ 8.0 → 9.8 ←
 beste Teiler 284.4 (5.) 381.4 (1.) 405.3 (3.)
 Trefferlage 2.55 mm rechts, 0.32 mm hoch
 Streuwert 3.31, horizontal: 3.64, vertikal: 2.94

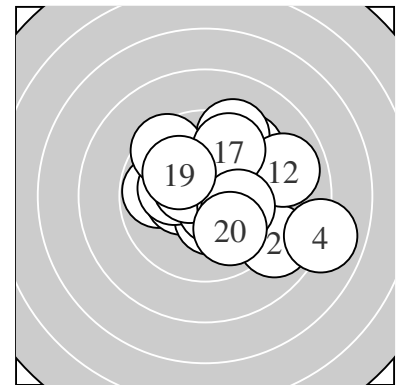
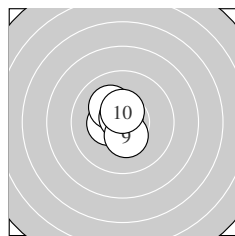

Serie 2:
 10.4 * 10.2 * 10.8 * 10.4 * 10.5 *
 beste Teiler 49.0 (8.) 110.0 (10.) 141.9 (9.)
 Trefferlage 0.49 mm links, 0.31 mm hoch
 Streuwert 0.98, horizontal: 0.79, vertikal: 1.13

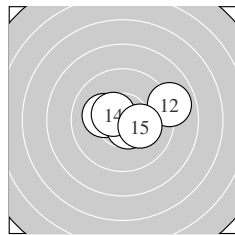

Serie 3:
 10.2 * 8.9 → 10.6 * 10.5 * 10.2 *
 beste Teiler 89.6 (13.) 111.8 (14.) 187.2 (15.)
 Trefferlage 0.85 mm rechts, 0.26 mm hoch
 Streuwert 1.96, horizontal: 2.60, vertikal: 0.95

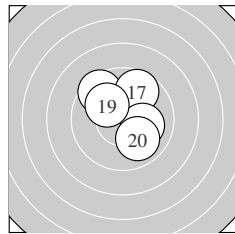

Serie 4:
 9.5 ↘ 9.7 ↗ 10.1 → 10.1 ↘ 9.9 ↘
 beste Teiler 212.5 (18.) 213.8 (19.) 251.8 (20.)
 Trefferlage 0.22 mm rechts, 0.87 mm hoch
 Streuwert 2.07, horizontal: 2.01, vertikal: 2.13

Unterschrift des Schützen

Ergebnis: **197** (206.8)
 Serien: 48 50 49 50
 Zähler: 17 3 0 0 0 0 0 0 0 0
 Innenzehner: 14
 weiteste: 343 (15), 297 (1), 290 (5)
 beste Teiler 55.2 (14.) 56.0 (8.) 62.8 (7.)
 Trefferlage 0.10 mm rechts, 0.20 mm tief
 Streuwert 1.26, horizontal: 1.50, vertikal: 0.96

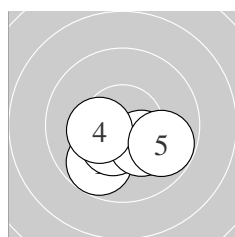
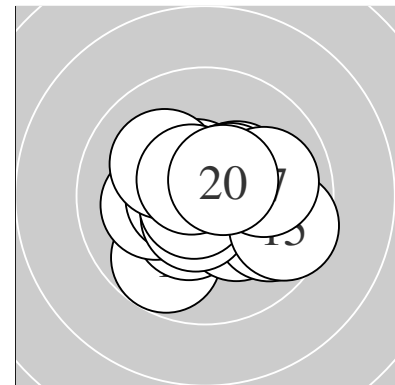

Serie 1:
 9.8 ↘ 10.4 * 10.2 * 10.3 * 9.8 ↘
 beste Teiler 136.0 (2.) 160.8 (4.) 177.5 (3.)
 Trefferlage 0.01 mm rechts, 1.30 mm tief
 Streuwert 1.43, horizontal: 1.87, vertikal: 0.78

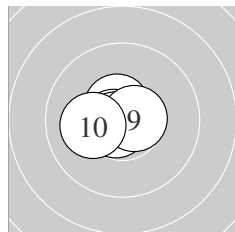

Serie 2:
 10.6 * 10.7 * 10.7 * 10.6 * 10.1 ←
 beste Teiler 56.0 (8.) 62.8 (7.) 79.7 (9.)
 Trefferlage 0.53 mm links, 0.03 mm hoch
 Streuwert 0.79, horizontal: 1.00, vertikal: 0.51

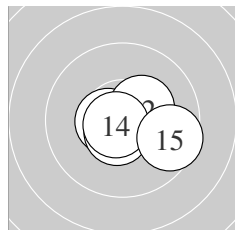

Serie 3:
 10.6 * 10.3 * 10.6 * 10.7 * 9.6 ↘
 beste Teiler 55.2 (14.) 92.1 (13.) 100.4 (11.)
 Trefferlage 0.53 mm rechts, 0.33 mm tief
 Streuwert 1.34, horizontal: 1.73, vertikal: 0.77

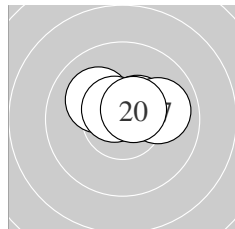

Serie 4:
 10.5 * 10.0 → 10.1 ↘ 10.6 * 10.6 *
 beste Teiler 86.6 (19.) 98.4 (20.) 124.6 (16.)
 Trefferlage 0.39 mm rechts, 0.78 mm hoch
 Streuwert 1.11, horizontal: 1.55, vertikal: 0.29

Unterschrift des Schützen

Ergebnis: **192** (200.9)
 Serien: 49 48 48 47
 Zähler: 15 3 1 1 0 0 0 0 0 0
 Innenzehner: 14
 weiteste: 812 (20), 516 (6), 410 (14)
 beste Teiler 35.1 (15.) 85.2 (13.) 87.6 (7.)
 Trefferlage 0.23 mm links, 0.82 mm hoch
 Streuwert 2.00, horizontal: 2.35, vertikal: 1.56

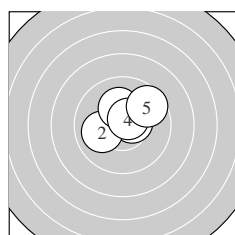
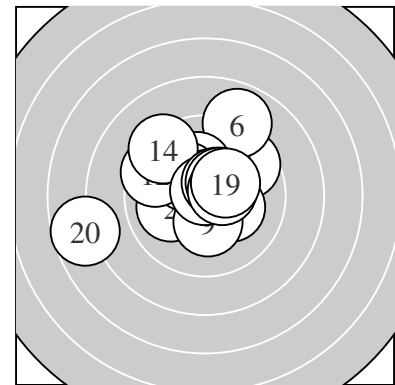

Serie 1:
 10.5 * 10.0 ← 10.2 * 10.6 * 9.6 ↗
 beste Teiler 90.6 (4.) 107.2 (1.) 189.2 (3.)
 Trefferlage 0.33 mm rechts, 0.83 mm hoch
 Streuwert 1.51, horizontal: 1.80, vertikal: 1.14

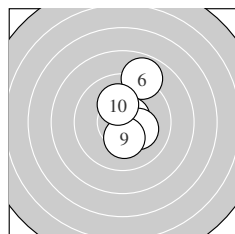

Serie 2:
 8.9 ↗ 10.6 * 10.2 * 10.3 * 10.2 *
 beste Teiler 87.6 (7.) 170.0 (9.) 181.7 (8.)
 Trefferlage 0.83 mm rechts, 0.94 mm hoch
 Streuwert 1.93, horizontal: 1.06, vertikal: 2.51

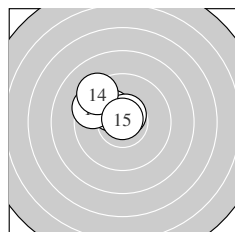

Serie 3:
 10.2 * 9.5 ↖ 10.6 * 9.3 ↘ 10.8 *
 beste Teiler 35.1 (15.) 85.2 (13.) 176.0 (11.)
 Trefferlage 1.38 mm links, 1.40 mm hoch
 Streuwert 1.34, horizontal: 1.58, vertikal: 1.03

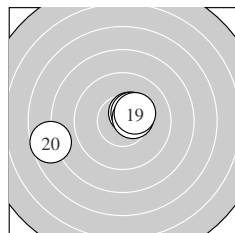

Serie 4:
 10.5 * 10.4 * 10.5 * 10.3 * 7.7 ←
 beste Teiler 114.4 (16.) 117.3 (18.) 132.3 (17.)
 Trefferlage 0.73 mm links, 0.13 mm hoch
 Streuwert 2.96, horizontal: 3.96, vertikal: 1.38

Unterschrift des Schützen

Meyton Elektronik

Ergebnis: **196** (204.7)
 Serien: 49 50 49 48
 Zähler: 16 4 0 0 0 0 0 0 0 0
 Innenzehner: 12
 weiteste: 322 (20), 310 (18), 286 (11)
 beste Teiler 7.8 (9.) 37.0 (14.) 91.0 (16.)
 Trefferlage 0.80 mm rechts, 0.45 mm hoch
 Streuwert 1.28, horizontal: 1.38, vertikal: 1.18

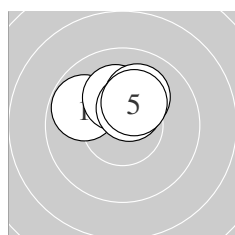
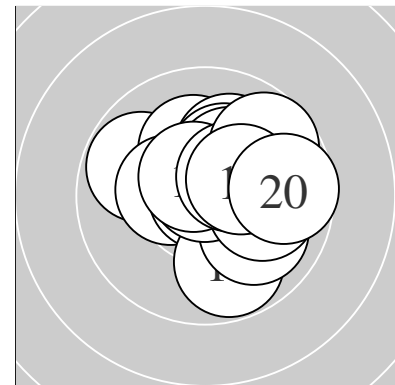

Serie 1:
 9.8 ↙ 10.2 * 10.1 ↗ 10.5 * 10.3 *
 beste Teiler 123.4 (4.) 171.7 (5.) 193.0 (2.)
 Trefferlage 0.17 mm links, 1.53 mm hoch
 Streuwert 1.07, horizontal: 1.47, vertikal: 0.37

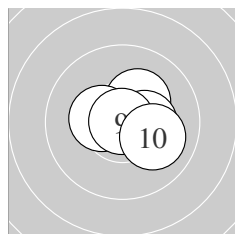

Serie 2:
 10.3 * 10.4 * 10.4 * 10.9 * 10.0 →
 beste Teiler 7.8 (9.) 143.1 (8.) 148.2 (7.)
 Trefferlage 0.61 mm rechts, 0.11 mm hoch
 Streuwert 1.14, horizontal: 1.37, vertikal: 0.85

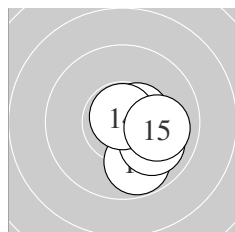

Serie 3:
 9.8 ↓ 10.0 ↘ 10.5 * 10.8 * 10.0 →
 beste Teiler 37.0 (14.) 106.6 (13.) 237.3 (15.)
 Trefferlage 1.25 mm rechts, 0.73 mm tief
 Streuwert 1.14, horizontal: 0.93, vertikal: 1.31

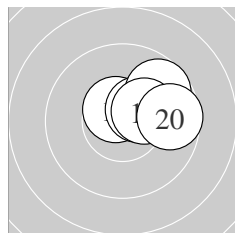

Serie 4:
 10.6 * 10.4 * 9.7 ↗ 10.3 * 9.7 →
 beste Teiler 91.0 (16.) 133.0 (17.) 161.9 (19.)
 Trefferlage 1.53 mm rechts, 0.90 mm hoch
 Streuwert 1.08, horizontal: 1.40, vertikal: 0.63

Unterschrift des Schützen

Ergebnis: **187** (196.2)
 Serien: 47 46 48 46
 Zähler: 8 11 1 0 0 0 0 0 0 0
 Innenzehner: 6
 weiteste: 739 (20), 451 (2), 435 (6)
 beste Teiler 66.2 (16.) 71.8 (19.) 82.7 (13.)
 Trefferlage 0.90 mm rechts, 0.02 mm hoch
 Streuwert 2.29, horizontal: 2.99, vertikal: 1.25

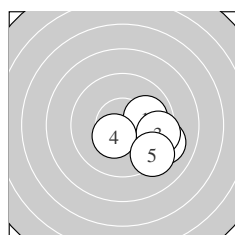
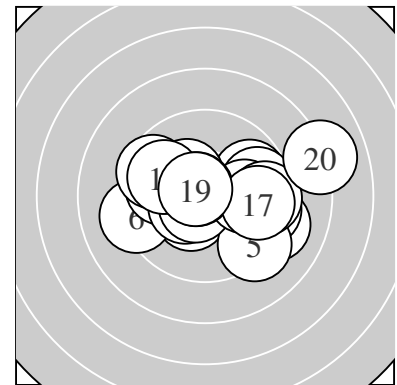

Serie 1:
 10.0 → 9.1 ↘ 9.5 ↘ 10.4 * 9.3 ↘
 beste Teiler 139.0 (4.) 243.8 (1.) 371.1 (3.)
 Trefferlage 2.45 mm rechts, 1.17 mm tief
 Streuwert 1.69, horizontal: 1.97, vertikal: 1.35

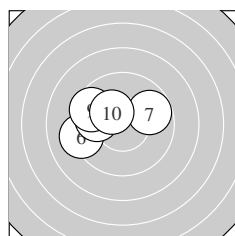

Serie 2:
 9.2 ← 9.8 ↗ 9.9 ← 9.6 ↖ 10.3 *
 beste Teiler 164.2 (10.) 264.3 (8.) 296.4 (7.)
 Trefferlage 1.66 mm links, 0.62 mm hoch
 Streuwert 2.05, horizontal: 2.69, vertikal: 1.10

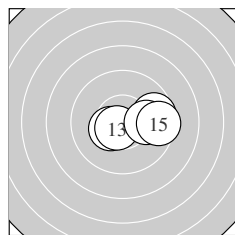

Serie 3:
 9.6 → 10.4 * 10.6 * 10.0 → 9.5 →
 beste Teiler 82.7 (13.) 137.8 (12.) 240.0 (14.)
 Trefferlage 1.48 mm rechts, 0.13 mm tief
 Streuwert 1.63, horizontal: 2.23, vertikal: 0.56

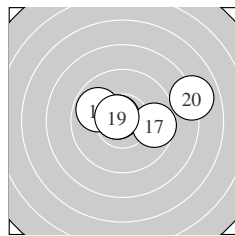

Serie 4:
 10.7 * 9.7 → 9.9 ↖ 10.7 * 8.0 →
 beste Teiler 66.2 (16.) 71.8 (19.) 274.2 (18.)
 Trefferlage 1.32 mm rechts, 0.78 mm hoch
 Streuwert 2.78, horizontal: 3.79, vertikal: 1.04

Unterschrift des Schützen

Meyton Elektronik

Ergebnis: **187** (195.1)
 Serien: 46 47 48 46
 Zähler: 9 9 2 0 0 0 0 0 0 0
 Innenzehner: 6
 weiteste: 592 (5), 582 (16), 499 (6)
 beste Teiler 44.0 (10.) 50.4 (14.) 67.8 (12.)
 Trefferlage 0.31 mm links, 0.30 mm tief
 Streuwert 2.47, horizontal: 2.85, vertikal: 2.01

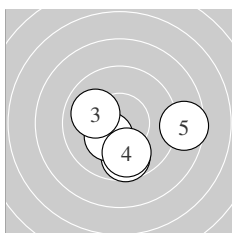
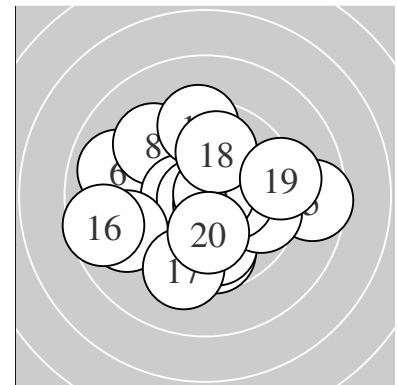

Serie 1:
 9.7 ↓ 10.3 * 10.0 ↖ 9.8 ↓ 8.6 →
 beste Teiler 158.5 (2.) 238.8 (3.) 276.5 (4.)
 Trefferlage 0.77 mm rechts, 1.28 mm tief
 Streuwert 2.50, horizontal: 3.11, vertikal: 1.67

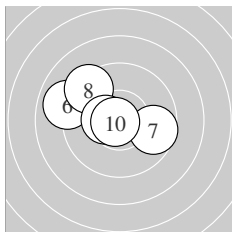

Serie 2:
 9.0 ↖ 9.7 → 9.3 ↖ 10.4 * 10.8 *
 beste Teiler 44.0 (10.) 129.0 (9.) 322.5 (7.)
 Trefferlage 1.24 mm links, 0.65 mm hoch
 Streuwert 2.33, horizontal: 2.94, vertikal: 1.49

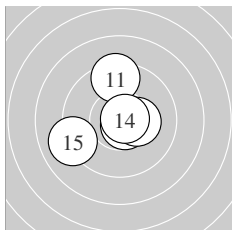

Serie 3:
 9.4 ↑ 10.7 * 10.3 * 10.8 * 9.1 ↖
 beste Teiler 50.4 (14.) 67.8 (12.) 157.7 (13.)
 Trefferlage 0.42 mm links, 0.28 mm hoch
 Streuwert 2.22, horizontal: 2.27, vertikal: 2.16

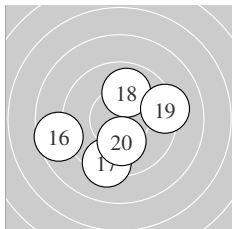

Serie 4:
 8.6 ↖ 9.3 ↓ 10.0 ↑ 9.2 → 10.1 ↓
 beste Teiler 203.7 (20.) 249.8 (18.) 417.0 (17.)
 Trefferlage 0.36 mm links, 0.85 mm tief
 Streuwert 3.08, horizontal: 3.53, vertikal: 2.54

Unterschrift des Schützen

Meyton Elektronik

Ergebnis: **194** (201.5)
 Serien: 50 48 48 48
 Zähler: 14 6 0 0 0 0 0 0 0 0
 Innenzehner: 10
 weiteste: 427 (17), 408 (14), 377 (7)
 beste Teiler 86.2 (8.) 92.5 (16.) 105.1 (4.)
 Trefferlage 0.70 mm links, 0.00 mm
 Streuwert 1.64, horizontal: 1.27, vertikal: 1.93

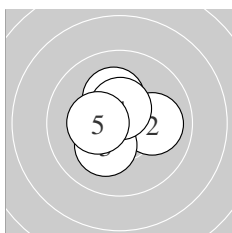
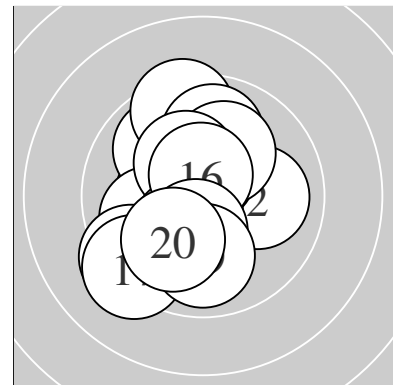

Serie 1:
 10.2 * 10.0 → 10.2 * 10.5 * 10.3 *
 beste Teiler 105.1 (4.) 156.0 (5.) 184.0 (1.)
 Trefferlage 0.11 mm links, 0.24 mm hoch
 Streuwert 1.40, horizontal: 1.51, vertikal: 1.28

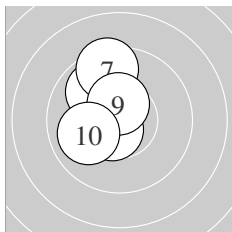

Serie 2:
 9.9 ↘ 9.4 ↑ 10.6 * 10.5 * 10.0 ←
 beste Teiler 86.2 (8.) 117.4 (9.) 243.7 (10.)
 Trefferlage 1.08 mm links, 1.04 mm hoch
 Streuwert 1.49, horizontal: 0.86, vertikal: 1.93

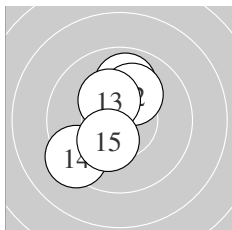

Serie 3:
 9.9 ↑ 10.1 ↗ 10.3 * 9.3 ↙ 10.3 *
 beste Teiler 161.4 (13.) 167.0 (15.) 205.2 (12.)
 Trefferlage 0.68 mm links, 0.35 mm hoch
 Streuwert 1.94, horizontal: 1.55, vertikal: 2.26

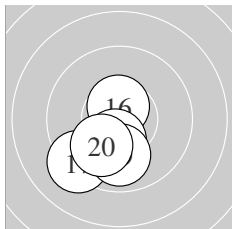

Serie 4:
 10.6 * 9.2 ↙ 10.3 * 9.9 ↓ 10.0 ↘
 beste Teiler 92.5 (16.) 155.3 (18.) 229.3 (20.)
 Trefferlage 0.94 mm links, 1.62 mm tief
 Streuwert 1.41, horizontal: 1.25, vertikal: 1.55

Unterschrift des Schützen

Meyton Elektronik

Ergebnis:	187	(196.1)
Serien:	45	48 47 47
Zähler:	8	11 1 0 0 0 0 0 0 0
Innenzehner:	5	
weiteste:	531 (2), 467 (4), 395 (15)	
beste Teiler	94.0 (8.)	134.0 (9.) 169.8 (16.)
Trefferlage	0.21 mm rechts, 1.20 mm hoch	
Streuwert	2.05, horizontal: 1.88, vertikal: 2.20	

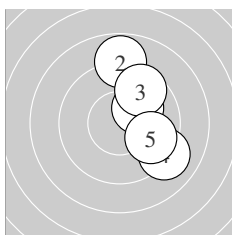
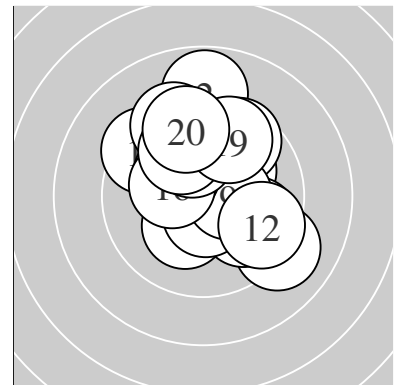

Serie 1:	10.1 ↗	8.8 ↑	9.6 ↗	9.1 ↘	9.8 ↘
beste Teiler	203.0 (1.)	297.5 (5.)	338.1 (3.)		
Trefferlage	2.00 mm rechts, 1.11 mm hoch				
Streuwert	2.46, horizontal: 1.40, vertikal: 3.18				

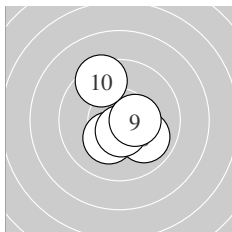

Serie 2:	9.9 ↘	10.2 *	10.6 *	10.4 *	9.5 ↖
beste Teiler	94.0 (8.)	134.0 (9.)	179.9 (7.)		
Trefferlage	0.21 mm rechts, 0.10 mm tief				
Streuwert	1.81, horizontal: 1.53, vertikal: 2.05				

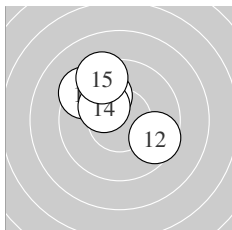

Serie 3:	10.0 ↖	9.6 ↘	9.4 ↖	10.2 *	9.4 ↖
beste Teiler	178.6 (14.)	239.4 (11.)	339.8 (12.)		
Trefferlage	0.80 mm links, 1.55 mm hoch				
Streuwert	2.11, horizontal: 2.28, vertikal: 1.93				

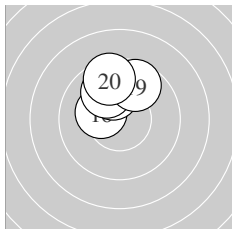

Serie 4:	10.3 *	10.1 ↖	9.9 ↖	9.7 ↗	9.5 ↖
beste Teiler	169.8 (16.)	223.1 (17.)	258.5 (18.)		
Trefferlage	0.56 mm links, 2.28 mm hoch				
Streuwert	1.11, horizontal: 1.13, vertikal: 1.08				

Unterschrift des Schützen

Ergebnis:	194	(201.6)
Serien:	48 48 49 49	
Zähler:	15 4 1 0 0 0 0 0 0 0	
Innenzehner:	12	
weiteste:	640 (6), 466 (16), 374 (13)	
beste Teiler	10.7 (8.) 34.9 (12.) 57.0 (2.)	
Trefferlage	0.52 mm links, 0.74 mm hoch	
Streuwert	1.80, horizontal: 1.90, vertikal: 1.70	

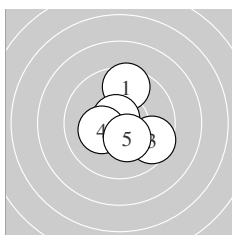
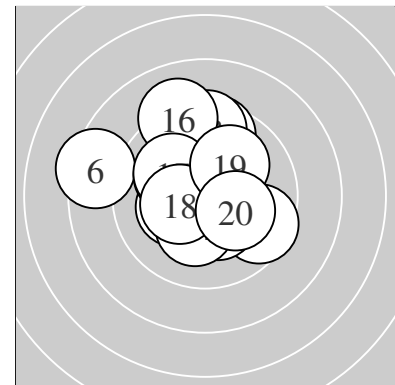

Serie 1:	9.6 ↑	10.7 *	9.6 ↘	10.2 *	10.3 *
beste Teiler	57.0 (2.)	156.0 (5.)	179.4 (4.)		
Trefferlage	0.47 mm rechts, 0.05 mm hoch				
Streuwert	1.90, horizontal: 1.73, vertikal: 2.05				

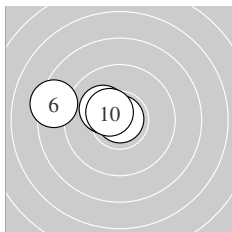

Serie 2:	8.4 ↙	10.3 *	10.9 *	10.2 *	10.5 *
beste Teiler	10.7 (8.)	120.4 (10.)	169.4 (7.)		
Trefferlage	2.02 mm links, 0.87 mm hoch				
Streuwert	1.75, horizontal: 2.42, vertikal: 0.53				

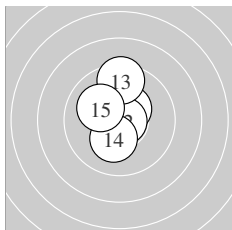

Serie 3:	10.4 *	10.8 *	9.5 ↑	10.2 *	10.1 ↘
beste Teiler	34.9 (12.)	130.8 (11.)	182.1 (14.)		
Trefferlage	0.22 mm links, 0.82 mm hoch				
Streuwert	1.58, horizontal: 1.01, vertikal: 2.00				

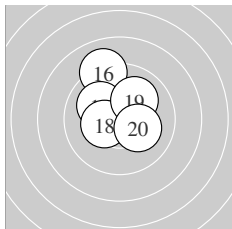

Serie 4:	9.1 ↖	10.1 ↘	10.4 *	10.1 ↗	10.2 *
beste Teiler	150.5 (18.)	191.4 (20.)	222.2 (17.)		
Trefferlage	0.33 mm links, 1.22 mm hoch				
Streuwert	1.92, horizontal: 1.74, vertikal: 2.09				

Unterschrift des Schützen

Meyton Elektronik

Ergebnis: **193** (201.8)
 Serien: 50 48 46 49
 Zähler: 13 7 0 0 0 0 0 0 0 0
 Innenzehner: 9
 weiteste: 468 (15), 320 (11), 290 (10)
 beste Teiler 53.3 (5.) 83.4 (6.) 150.5 (20.)
 Trefferlage 0.75 mm rechts, 0.37 mm tief
 Streuwert 1.57, horizontal: 1.76, vertikal: 1.35

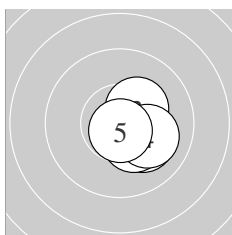
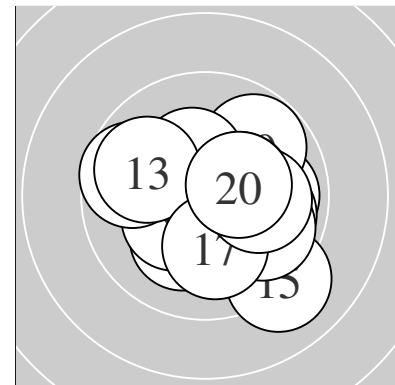

Serie 1:
 10.1 ↘ 10.3 * 10.3 * 10.1 ↘ 10.7 *
 beste Teiler 53.3 (5.) 158.3 (3.) 158.5 (2.)
 Trefferlage 1.17 mm rechts, 0.58 mm tief
 Streuwert 0.84, horizontal: 0.73, vertikal: 0.93

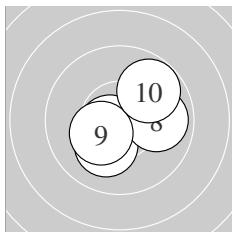

Serie 2:
 10.6 * 10.2 * 9.9 → 10.3 * 9.8 ↗
 beste Teiler 83.4 (6.) 159.2 (9.) 200.0 (7.)
 Trefferlage 0.34 mm rechts, 0.21 mm tief
 Streuwert 1.64, horizontal: 1.83, vertikal: 1.43

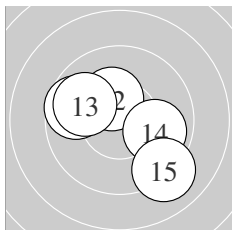

Serie 3:
 9.7 ← 10.3 * 9.9 ↖ 9.9 → 9.1 ↘
 beste Teiler 158.8 (12.) 260.2 (14.) 268.9 (13.)
 Trefferlage 0.09 mm links, 0.16 mm tief
 Streuwert 2.47, horizontal: 2.81, vertikal: 2.07

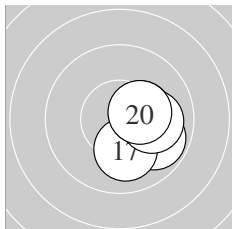

Serie 4:
 9.8 ↘ 10.1 ↓ 10.3 * 10.0 → 10.4 *
 beste Teiler 150.5 (20.) 153.0 (18.) 217.2 (17.)
 Trefferlage 1.60 mm rechts, 0.54 mm tief
 Streuwert 0.99, horizontal: 0.80, vertikal: 1.15

Unterschrift des Schützen

Meyton Elektronik

Ergebnis: **183** (191.6)
 Serien: 44 47 47 45
 Zähler: 6 11 3 0 0 0 0 0 0 0
 Innenzehner: 6
 weiteste: 666 (17), 557 (1), 520 (2)
 beste Teiler 60.5 (5.) 61.6 (16.) 115.9 (12.)
 Trefferlage 0.79 mm rechts, 1.16 mm tief
 Streuwert 2.60, horizontal: 2.87, vertikal: 2.29

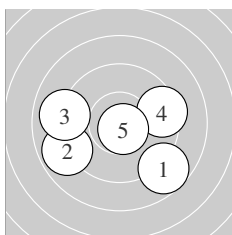
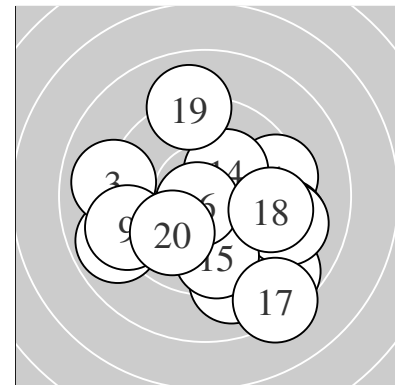

Serie 1:
 8.7 ↘ 8.9 ← 9.0 ← 9.4 → 10.7 *
 beste Teiler 60.5 (5.) 388.3 (4.) 490.4 (3.)
 Trefferlage 0.30 mm links, 1.03 mm tief
 Streuwert 3.39, horizontal: 4.29, vertikal: 2.13

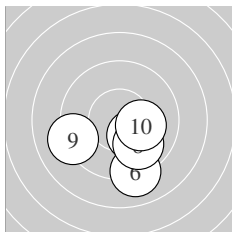

Serie 2:
 9.1 ↓ 10.3 * 9.9 ↘ 9.2 ← 10.2 *
 beste Teiler 174.7 (7.) 193.5 (10.) 267.8 (8.)
 Trefferlage 0.38 mm rechts, 2.02 mm tief
 Streuwert 2.09, horizontal: 2.53, vertikal: 1.52

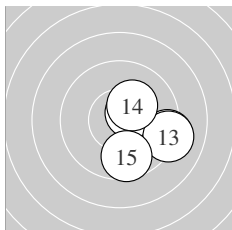

Serie 3:
 9.2 ↗ 10.5 * 9.1 ↗ 10.3 * 9.7 ↓
 beste Teiler 115.9 (12.) 170.9 (14.) 324.7 (15.)
 Trefferlage 2.24 mm rechts, 0.80 mm tief
 Streuwert 1.83, horizontal: 1.86, vertikal: 1.80

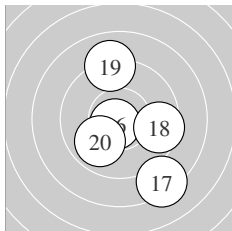

Serie 4:
 10.7 * 8.3 ↘ 9.5 → 9.0 ↑ 9.9 ↙
 beste Teiler 61.6 (16.) 262.0 (20.) 356.7 (18.)
 Trefferlage 0.84 mm rechts, 0.79 mm tief
 Streuwert 3.17, horizontal: 2.57, vertikal: 3.68

Unterschrift des Schützen

Meyton Elektronik

Ergebnis: **185** (193.3)
 Serien: 47 45 46 47
 Zähler: 9 7 4 0 0 0 0 0 0 0
 Innenzehner: 6
 weiteste: 672 (4), 664 (16), 639 (8)
 beste Teiler 41.1 (14.) 86.0 (19.) 127.4 (3.)
 Trefferlage 0.28 mm rechts, 1.74 mm tief
 Streuwert 2.39, horizontal: 2.83, vertikal: 1.86

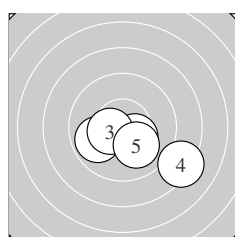
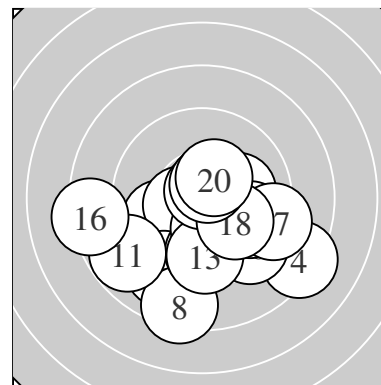

Serie 1:
 10.3 * 9.9 ← 10.4 * 8.3 ↘ 10.1 ↘
 beste Teiler 127.4 (3.) 151.6 (1.) 219.0 (5.)
 Trefferlage 0.91 mm rechts, 1.57 mm tief
 Streuwert 2.36, horizontal: 3.10, vertikal: 1.23

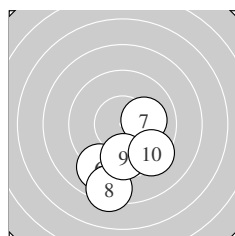

Serie 2:
 9.1 ↓ 10.1 → 8.4 ↓ 9.7 ↓ 9.4 ↘
 beste Teiler 211.6 (7.) 317.1 (9.) 395.2 (10.)
 Trefferlage 0.28 mm rechts, 3.20 mm tief
 Streuwert 2.29, horizontal: 2.15, vertikal: 2.42

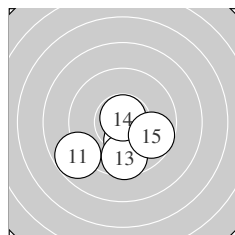

Serie 3:
 8.8 ← 10.2 * 9.6 ↓ 10.8 * 9.7 ↘
 beste Teiler 41.1 (14.) 182.6 (12.) 308.3 (15.)
 Trefferlage 0.18 mm links, 1.84 mm tief
 Streuwert 2.14, horizontal: 2.59, vertikal: 1.55

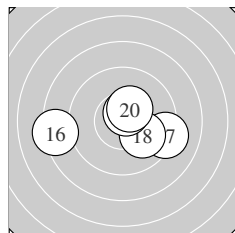

Serie 4:
 8.3 ← 9.2 → 10.0 ↘ 10.6 * 10.4 *
 beste Teiler 86.0 (19.) 137.2 (20.) 235.5 (18.)
 Trefferlage 0.11 mm rechts, 0.37 mm tief
 Streuwert 2.98, horizontal: 4.02, vertikal: 1.25

Unterschrift des Schützen

Meyton Elektronik