

Ergebnis: **168.9** (161)
 Serien: 83.0 85.9
 Zähler: 3 6 6 2 1 1 1 0 0 0
 Innenzehner: 1
 weiteste: 1600 (8), 1369 (3), 1075 (7)
 beste Teiler 163.4 (5.) 229.3 (2.) 248.8 (18.)
 Trefferlage 1.92 mm links, 0.61 mm hoch
 Streuwert 5.10, horizontal: 6.73, vertikal: 2.58

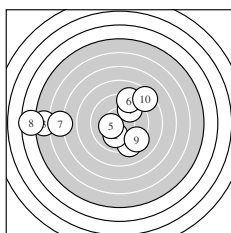

Serie 1:
 9.3 ↘ 10.0 ↙ 5.5 ← 9.7 ↗ 10.3 *
 9.2 ↗ 6.7 ← 4.6 ← 9.3 ↘ 8.4 ↗
 beste Teiler 163.4 (5.) 229.3 (2.) 308.0 (4.)
 Trefferlage 2.97 mm links, 0.15 mm hoch
 Streuwert 5.69, horizontal: 7.55, vertikal: 2.80

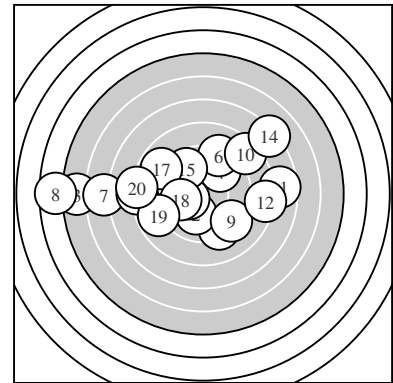
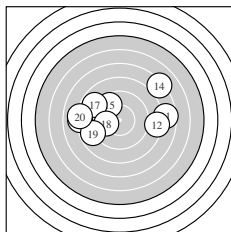

Serie 2:
 7.6 → 8.2 → 9.6 ↖ 7.1 ↗ 9.6 ↖
 8.1 ← 8.8 ↖ 10.0 ← 8.8 ← 8.1 ←
 beste Teiler 248.8 (18.) 328.3 (15.) 331.2 (13.)
 Trefferlage 0.86 mm links, 1.08 mm hoch
 Streuwert 4.57, horizontal: 6.00, vertikal: 2.41

Unterschrift des Schützen

Ergebnis: **187.1** (179)
 Serien: 93.7 93.4
 Zähler: 6 8 5 1 0 0 0 0 0 0
 Innenzehner: 5
 weiteste: 921 (6), 672 (17), 626 (7)
 beste Teiler 65.7 (2.) 94.8 (10.) 101.7 (20.)
 Trefferlage 2.03 mm links, 0.60 mm hoch
 Streuwert 2.93, horizontal: 3.69, vertikal: 1.88

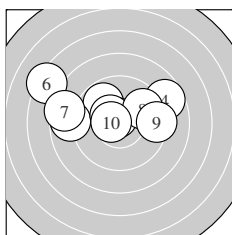
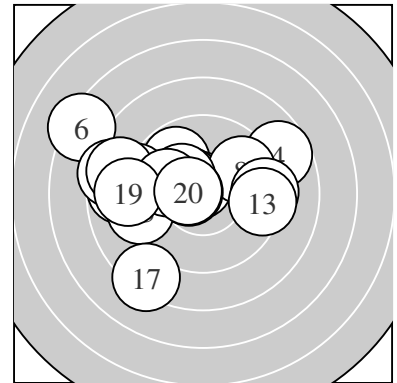

Serie 1:
 9.8 ↘ 10.7 * 8.8 ← 8.7 ↗ 10.4 *
 7.3 ↘ 8.4 ← 9.7 ↗ 9.3 → 10.6 *
 beste Teiler 65.7 (2.) 94.8 (10.) 136.2 (5.)
 Trefferlage 1.20 mm links, 1.41 mm hoch
 Streuwert 3.24, horizontal: 4.37, vertikal: 1.37

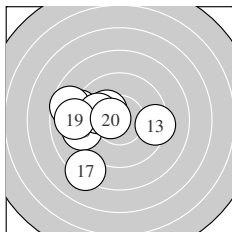

Serie 2:
 9.0 ← 9.1 ← 9.4 → 8.7 ← 9.2 ←
 10.2 * 8.3 ↙ 10.0 ← 9.0 ← 10.5 *
 beste Teiler 101.7 (20.) 179.0 (16.) 249.5 (18.)
 Trefferlage 2.86 mm links, 0.21 mm tief
 Streuwert 2.48, horizontal: 2.85, vertikal: 2.03

Unterschrift des Schützen

Ergebnis: **190.0** (182)
 Serien: 95.9 94.1
 Zähler: 8 6 6 0 0 0 0 0 0 0
 Innenzehner: 7
 weiteste: 694 (15), 668 (20), 627 (17)
 beste Teiler 66.6 (9.) 120.1 (4.) 126.4 (11.)
 Trefferlage 0.44 mm rechts, 1.14 mm hoch
 Streuwert 2.89, horizontal: 3.51, vertikal: 2.11

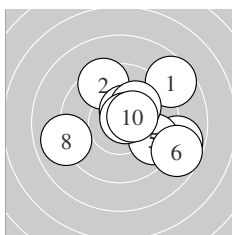
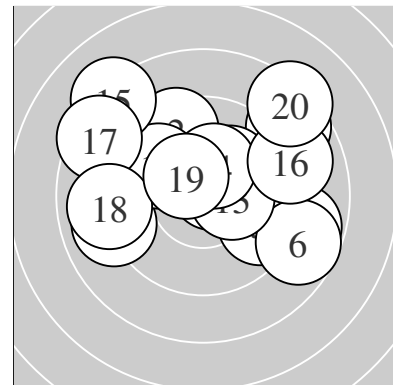

Serie 1:
 8.6 ↗ 9.5 ↘ 8.8 → 10.5 * 9.6 ↘
 8.7 ↘ 10.1 ↗ 9.0 ← 10.7 * 10.4 *
 beste Teiler 66.6 (9.) 120.1 (4.) 126.5 (10.)
 Trefferlage 1.49 mm rechts, 0.37 mm hoch
 Streuwert 2.65, horizontal: 3.09, vertikal: 2.12

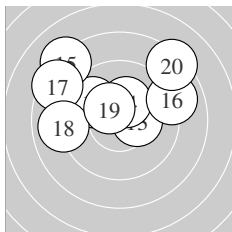

Serie 2:
 10.4 * 9.8 ↘ 10.3 * 10.3 * 8.2 ↘
 9.0 → 8.4 ↘ 9.0 ← 10.4 * 8.3 ↗
 beste Teiler 126.4 (11.) 137.5 (19.) 153.1 (13.)
 Trefferlage 0.60 mm links, 1.90 mm hoch
 Streuwert 2.97, horizontal: 3.74, vertikal: 1.90

Unterschrift des Schützen

Ergebnis: **183.1** (176)
 Serien: 92.8 90.3
 Zähler: 6 7 4 3 0 0 0 0 0 0
 Innenzehner: 3
 weiteste: 952 (13), 944 (14), 794 (8)
 beste Teiler 79.5 (10.) 174.8 (20.) 184.2 (9.)
 Trefferlage 1.15 mm links, 0.35 mm hoch
 Streuwert 3.63, horizontal: 4.78, vertikal: 1.86

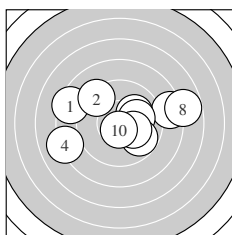
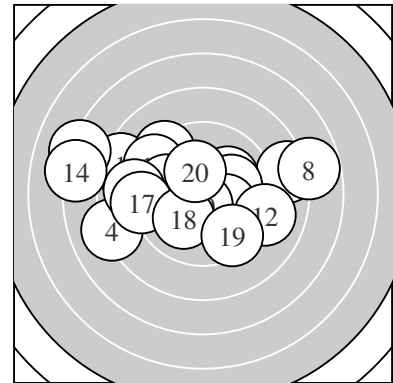

Serie 1:
 8.4 ↖ 9.3 ↘ 8.4 → 8.1 ← 10.1 ↗
 10.1 → 9.8 ↘ 7.8 → 10.2 * 10.6 *
 beste Teiler 79.5 (10.) 184.2 (9.) 215.1 (6.)
 Trefferlage 0.62 mm rechts, 0.46 mm hoch
 Streuwert 3.56, horizontal: 4.68, vertikal: 1.86

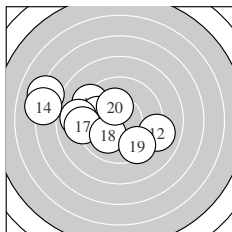

Serie 2:
 9.3 ↖ 9.0 → 7.1 ↖ 7.2 ← 9.9 ←
 8.9 ← 9.1 ← 10.0 ↙ 9.5 ↘ 10.3 *
 beste Teiler 174.8 (20.) 226.1 (18.) 271.6 (15.)
 Trefferlage 2.93 mm links, 0.25 mm hoch
 Streuwert 3.40, horizontal: 4.39, vertikal: 1.96

Unterschrift des Schützen

Ergebnis: **199.7** (190)
 Serien: 100.5 99.2
 Zähler: 10 10 0 0 0 0 0 0 0 0
 Innenzehner: 7
 weiteste: 446 (10), 434 (2), 360 (13)
 beste Teiler 13.0 (8.) 61.8 (6.) 98.0 (4.)
 Trefferlage 0.77 mm links, 0.99 mm tief
 Streuwert 1.74, horizontal: 1.95, vertikal: 1.51

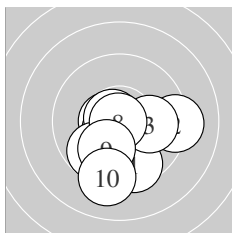
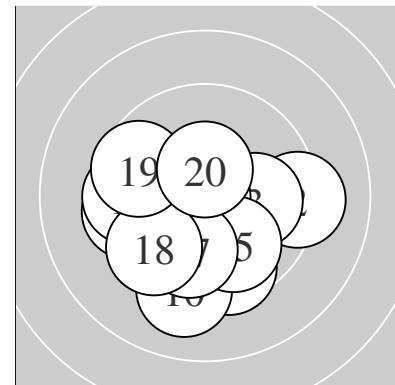

Serie 1:
 9.5 ↓ 9.2 → 10.0 → 10.6 * 10.6 *
 10.7 * 9.8 ↙ 10.9 * 10.0 ↘ 9.2 ↓
 beste Teiler 13.0 (8.) 61.8 (6.) 98.0 (4.)
 Trefferlage 0.15 mm rechts, 1.30 mm tief
 Streuwert 1.77, horizontal: 1.90, vertikal: 1.62

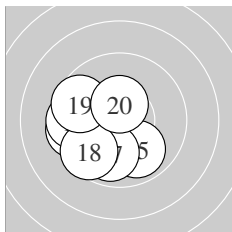

Serie 2:
 10.1 ← 10.3 * 9.5 ← 10.3 * 9.9 ↓
 9.5 ← 9.9 ↓ 9.6 ↙ 9.6 ↖ 10.5 *
 beste Teiler 124.0 (20.) 153.3 (14.) 175.2 (12.)
 Trefferlage 1.70 mm links, 0.67 mm tief
 Streuwert 1.48, horizontal: 1.57, vertikal: 1.39

Unterschrift des Schützen

Ergebnis: **183.4** (173)
 Serien: 96.9 86.5
 Zähler: 4 9 4 2 1 0 0 0 0 0
 Innenzehner: 4
 weiteste: 1148 (16), 938 (15), 857 (10)
 beste Teiler 90.4 (9.) 112.4 (3.) 134.6 (7.)
 Trefferlage 0.80 mm links, 0.32 mm tief
 Streuwert 3.78, horizontal: 4.52, vertikal: 2.85

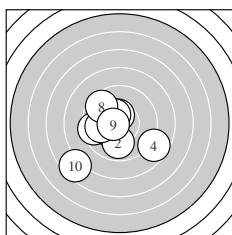
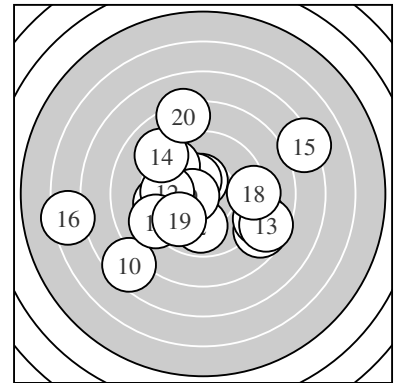

Serie 1:
 10.3 * 9.9 ↓ 10.5 * 8.7 ↘ 9.5 ←
 9.9 ← 10.4 * 9.6 ↖ 10.6 * 7.5 ↙
 beste Teiler 90.4 (9.) 112.4 (3.) 134.6 (7.)
 Trefferlage 1.33 mm links, 0.96 mm tief
 Streuwert 2.63, horizontal: 2.83, vertikal: 2.42

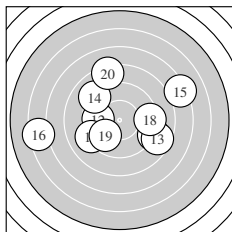

Serie 2:
 8.9 ↘ 9.8 ← 8.6 ↘ 9.1 ↖ 7.2 ↗
 6.4 ← 9.1 ↙ 9.3 → 9.8 ↗ 8.3 ↑
 beste Teiler 291.4 (19.) 300.4 (12.) 424.1 (18.)
 Trefferlage 0.27 mm links, 0.30 mm hoch
 Streuwert 4.74, horizontal: 5.87, vertikal: 3.22

Unterschrift des Schützen

Ergebnis: **197.0** (188)
 Serien: 99.8 97.2
 Zähler: 10 8 2 0 0 0 0 0 0 0
 Innenzehner: 7
 weiteste: 701 (8), 538 (15), 484 (14)
 beste Teiler 34.0 (6.) 47.8 (9.) 58.8 (1.)
 Trefferlage 1.00 mm links, 0.13 mm hoch
 Streuwert 2.23, horizontal: 2.82, vertikal: 1.43

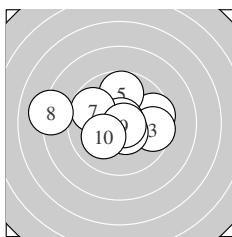
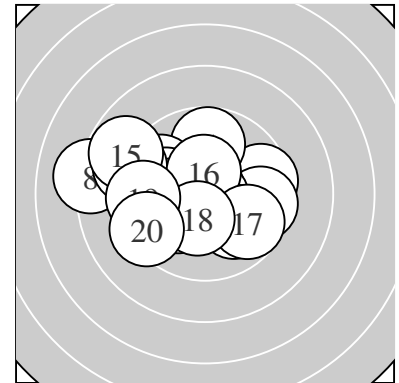

Serie 1:
 10.7 * 9.6 → 9.6 → 10.5 * 9.8 ↑
 10.8 * 9.8 ↖ 8.1 ← 10.8 * 10.1 ↙
 beste Teiler 34.0 (6.) 47.8 (9.) 58.8 (1.)
 Trefferlage 0.28 mm links, 0.39 mm hoch
 Streuwert 2.29, horizontal: 2.99, vertikal: 1.26

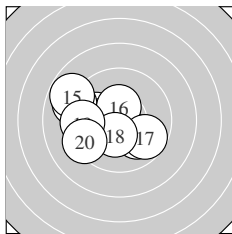

Serie 2:
 10.0 ↖ 10.2 * 10.0 ↘ 9.0 ↖ 8.8 ↖
 10.4 * 9.7 ↘ 10.3 * 9.5 ← 9.3 ↙
 beste Teiler 133.2 (16.) 154.9 (18.) 200.2 (12.)
 Trefferlage 1.72 mm links, 0.13 mm tief
 Streuwert 2.15, horizontal: 2.58, vertikal: 1.61

Unterschrift des Schützen

Ergebnis: **177.8** (171)
 Serien: 95.2 82.6
 Zähler: 6 7 4 0 1 2 0 0 0 0
 Innenzehner: 5
 weiteste: 1458 (12), 1283 (13), 1054 (20)
 beste Teiler 87.6 (18.) 104.4 (4.) 124.6 (8.)
 Trefferlage 1.16 mm links, 1.43 mm tief
 Streuwert 4.42, horizontal: 6.07, vertikal: 1.53

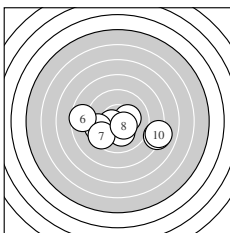
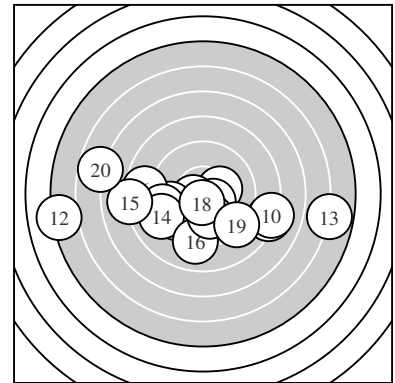

Serie 1:
 9.7 ← 10.3 * 10.2 * 10.5 * 9.6 ←
 8.6 ← 9.5 ↙ 10.5 * 8.2 → 8.1 →
 beste Teiler 104.4 (4.) 124.6 (8.) 174.3 (2.)
 Trefferlage 0.11 mm rechts, 1.12 mm tief
 Streuwert 3.03, horizontal: 4.14, vertikal: 1.11

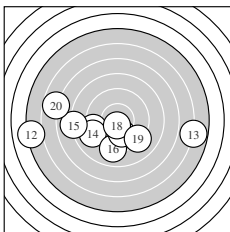

Serie 2:
 9.2 ← 5.1 ← 5.8 → 9.1 ← 8.0 ←
 9.0 ↓ 10.0 ↓ 10.6 * 9.1 ↘ 6.7 ←
 beste Teiler 87.6 (18.) 233.1 (17.) 426.0 (11.)
 Trefferlage 2.44 mm links, 1.74 mm tief
 Streuwert 5.49, horizontal: 7.54, vertikal: 1.87

Unterschrift des Schützen

Ergebnis: **200.5** (192)
 Serien: 100.2 100.3
 Zähler: 12 8 0 0 0 0 0 0 0 0
 Innenzehner: 7
 weiteste: 450 (19), 335 (2), 307 (16)
 beste Teiler 88.0 (20.) 119.8 (17.) 148.4 (15.)
 Trefferlage 0.13 mm rechts, 0.03 mm hoch
 Streuwert 1.78, horizontal: 2.19, vertikal: 1.25

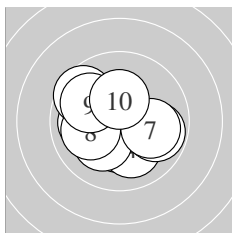
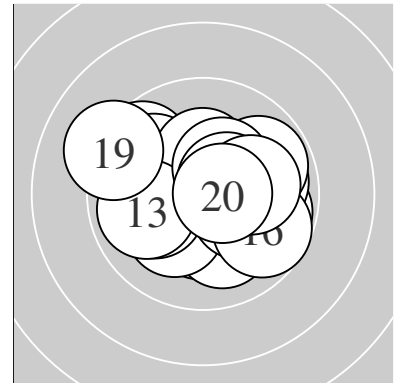

Serie 1:
 10.0 ← 9.6 ↖ 10.3 * 10.1 ↘ 9.8 →
 10.2 * 10.0 → 10.0 ← 9.9 ↖ 10.3 *
 beste Teiler 162.3 (3.) 164.0 (10.) 197.9 (6.)
 Trefferlage 0.50 mm links, 0.23 mm tief
 Streuwert 1.73, horizontal: 1.99, vertikal: 1.42

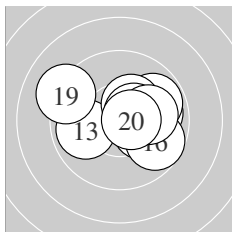

Serie 2:
 9.9 → 9.8 ↗ 9.9 ← 10.2 * 10.4 *
 9.7 ↘ 10.5 * 10.1 → 9.2 ↖ 10.6 *
 beste Teiler 88.0 (20.) 119.8 (17.) 148.4 (15.)
 Trefferlage 0.77 mm rechts, 0.30 mm hoch
 Streuwert 1.78, horizontal: 2.28, vertikal: 1.06

Unterschrift des Schützen

Ergebnis: **185.5** (178)
 Serien: 94.4 91.1
 Zähler: 8 5 5 1 1 0 0 0 0 0
 Innenzehner: 3
 weiteste: 1041 (11), 799 (15), 704 (16)
 beste Teiler 108.8 (2.) 138.6 (17.) 198.3 (14.)
 Trefferlage 0.94 mm rechts, 0.39 mm hoch
 Streuwert 3.44, horizontal: 4.66, vertikal: 1.42

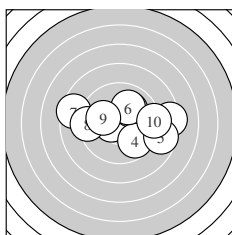
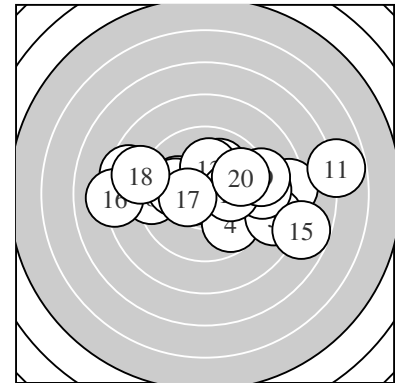

Serie 1:
 8.3 → 10.5 * 10.1 ↗ 9.7 ↘ 8.7 →
 10.0 ↗ 8.5 ← 9.3 ← 10.1 ← 9.2 →
 beste Teiler 108.8 (2.) 222.9 (9.) 225.6 (3.)
 Trefferlage 0.75 mm rechts, 0.25 mm hoch
 Streuwert 3.07, horizontal: 4.10, vertikal: 1.42

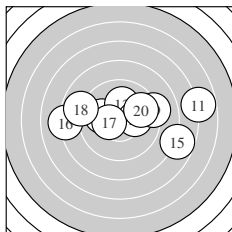

Serie 2:
 6.8 → 10.0 ← 10.1 ↑ 10.2 * 7.8 →
 8.1 ← 10.4 * 8.9 ← 9.1 → 9.7 →
 beste Teiler 138.6 (17.) 198.3 (14.) 211.1 (13.)
 Trefferlage 1.14 mm rechts, 0.54 mm hoch
 Streuwert 3.94, horizontal: 5.38, vertikal: 1.47

Unterschrift des Schützen

Ergebnis: **195.7** (186)
 Serien: 95.6 100.1
 Zähler: 10 8 1 0 1 0 0 0 0 0
 Innenzehner: 9
 weiteste: 1022 (2), 549 (8), 478 (10)
 beste Teiler 33.1 (17.) 86.4 (16.) 103.5 (3.)
 Trefferlage 0.87 mm rechts, 0.59 mm tief
 Streuwert 2.52, horizontal: 3.30, vertikal: 1.35

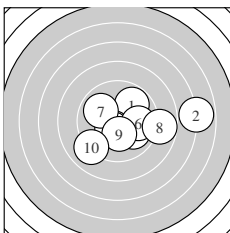
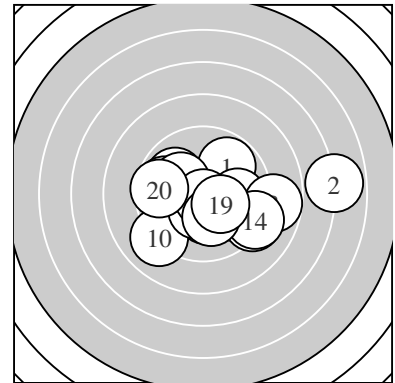

Serie 1:
 9.8 ↗ 6.9 → 10.5 * 10.5 * 10.0 ↘
 9.9 → 9.9 ↖ 8.8 → 10.3 * 9.0 ↙
 beste Teiler 103.5 (3.) 123.4 (4.) 166.3 (9.)
 Trefferlage 1.55 mm rechts, 0.49 mm tief
 Streuwert 3.02, horizontal: 3.96, vertikal: 1.60

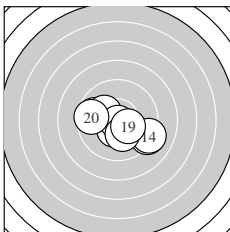

Serie 2:
 10.4 * 9.2 ↘ 9.7 ← 9.1 ↘ 10.2 *
 10.6 * 10.8 * 10.2 * 10.3 * 9.6 ←
 beste Teiler 33.1 (17.) 86.4 (16.) 134.1 (11.)
 Trefferlage 0.19 mm rechts, 0.69 mm tief
 Streuwert 1.95, horizontal: 2.51, vertikal: 1.14

Unterschrift des Schützen

Ergebnis: **198.2** (186)
 Serien: 99.2 99.0
 Zähler: 8 10 2 0 0 0 0 0 0 0
 Innenzehner: 7
 weiteste: 559 (4), 550 (1), 476 (20)
 beste Teiler 31.0 (3.) 31.1 (2.) 51.4 (14.)
 Trefferlage 1.13 mm rechts, 0.76 mm hoch
 Streuwert 1.98, horizontal: 2.44, vertikal: 1.37

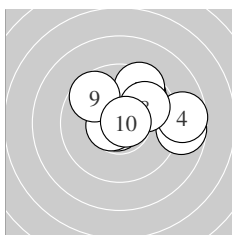
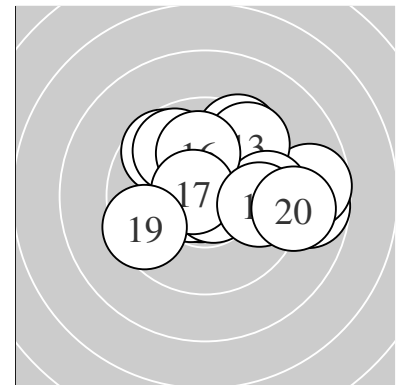

Serie 1:
 8.8 → 10.8 * 10.8 * 8.7 → 9.7 ↗
 10.6 * 9.5 ↗ 9.9 ↗ 9.7 ↘ 10.7 *
 beste Teiler 31.0 (3.) 31.1 (2.) 56.5 (10.)
 Trefferlage 1.42 mm rechts, 0.93 mm hoch
 Streuwert 2.02, horizontal: 2.54, vertikal: 1.31

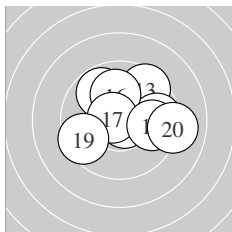

Serie 2:
 10.4 * 9.8 ↘ 9.5 ↗ 10.7 * 9.6 →
 10.0 ↑ 10.7 * 9.8 → 9.5 ↙ 9.0 →
 beste Teiler 51.4 (14.) 67.3 (17.) 131.6 (11.)
 Trefferlage 0.84 mm rechts, 0.58 mm hoch
 Streuwert 2.02, horizontal: 2.44, vertikal: 1.49

Unterschrift des Schützen

Ergebnis: **179.2** (171)
 Serien: 86.6 92.6
 Zähler: 4 7 6 2 1 0 0 0 0 0
 Innenzehner: 3
 weiteste: 1034 (9), 945 (12), 907 (18)
 beste Teiler 130.0 (16.) 156.2 (3.) 192.0 (19.)
 Trefferlage 0.17 mm rechts, 0.80 mm hoch
 Streuwert 4.04, horizontal: 5.37, vertikal: 1.97

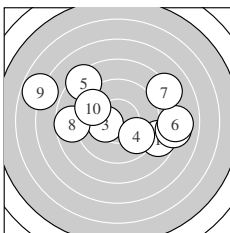
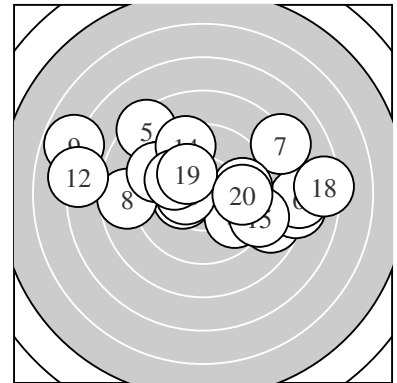

Serie 1:
 8.7 ↘ 8.1 → 10.3 * 9.8 ↘ 8.4 ↖
 8.1 → 8.2 ↗ 8.7 ← 6.8 ↖ 9.5 ↖
 beste Teiler 156.2 (3.) 297.6 (4.) 354.5 (10.)
 Trefferlage 0.32 mm rechts, 0.78 mm hoch
 Streuwert 4.58, horizontal: 5.97, vertikal: 2.51

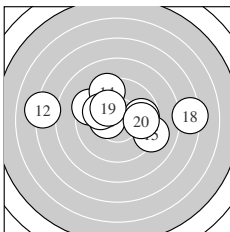

Serie 2:
 9.4 ↖ 7.2 ← 9.8 → 9.4 ↗ 9.1 →
 10.4 * 10.0 ↖ 7.3 → 10.2 * 9.8 →
 beste Teiler 130.0 (16.) 192.0 (19.) 238.8 (17.)
 Trefferlage 0.03 mm rechts, 0.82 mm hoch
 Streuwert 3.68, horizontal: 5.02, vertikal: 1.38

Unterschrift des Schützen

Ergebnis: **181.1** (171)
 Serien: 88.0 93.1
 Zähler: 4 8 5 2 0 1 0 0 0 0
 Innenzehner: 4
 weiteste: 1500 (7), 946 (20), 778 (2)
 beste Teiler 86.5 (17.) 114.0 (10.) 144.3 (13.)
 Trefferlage 0.20 mm links, 0.16 mm hoch
 Streuwert 4.19, horizontal: 5.63, vertikal: 1.85

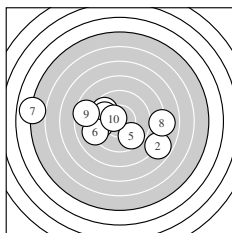
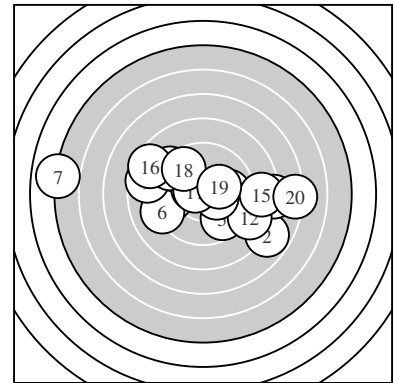

Serie 1:
 9.7 ↘ 7.8 ↘ 9.6 ← 9.9 ↖ 9.7 ↘
 9.1 ← 5.0 ← 8.1 → 8.6 ↖ 10.5 *
 beste Teiler 114.0 (10.) 274.4 (4.) 316.5 (1.)
 Trefferlage 1.84 mm links, 0.28 mm tief
 Streuwert 4.71, horizontal: 6.35, vertikal: 2.01

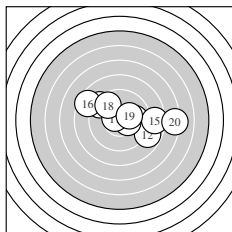

Serie 2:
 9.9 → 8.8 ↘ 10.4 * 9.2 ↖ 8.6 →
 8.5 ↖ 10.6 * 9.7 ↖ 10.2 * 7.2 →
 beste Teiler 86.5 (17.) 144.3 (13.) 181.7 (19.)
 Trefferlage 1.42 mm rechts, 0.61 mm hoch
 Streuwert 3.41, horizontal: 4.53, vertikal: 1.65

Unterschrift des Schützen

Ergebnis: **189.6** (182)
 Serien: 93.4 96.2
 Zähler: 9 7 1 3 0 0 0 0 0 0
 Innenzehner: 5
 weiteste: 794 (14), 780 (9), 767 (17)
 beste Teiler 106.2 (13.) 146.4 (19.) 159.1 (20.)
 Trefferlage 1.86 mm links, 0.39 mm tief
 Streuwert 2.79, horizontal: 3.58, vertikal: 1.67

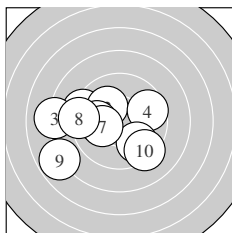
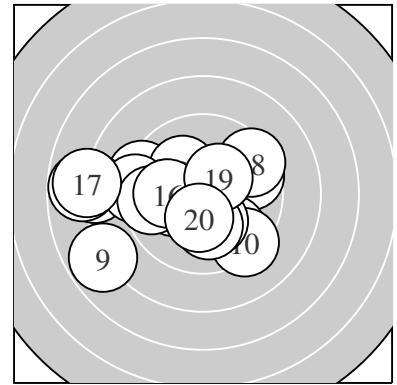

Serie 1:
 9.3 ← 10.1 ↖ 8.1 ← 9.6 → 10.0 ←
 9.8 ↘ 10.2 * 9.2 ← 7.8 ↙ 9.3 ↘
 beste Teiler 196.5 (7.) 207.1 (2.) 248.0 (5.)
 Trefferlage 2.02 mm links, 0.55 mm tief
 Streuwert 2.96, horizontal: 3.67, vertikal: 2.00

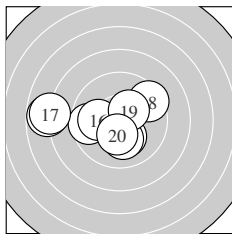

Serie 2:
 10.2 * 10.1 ↓ 10.5 * 7.8 ← 9.6 ←
 10.0 ← 7.9 ← 9.4 ↗ 10.4 * 10.3 *
 beste Teiler 106.2 (13.) 146.4 (19.) 159.1 (20.)
 Trefferlage 1.70 mm links, 0.23 mm tief
 Streuwert 2.77, horizontal: 3.67, vertikal: 1.34

Unterschrift des Schützen

Ergebnis: **188.3** (178)
 Serien: 93.6 94.7
 Zähler: 4 10 6 0 0 0 0 0 0 0
 Innenzehner: 3
 weiteste: 715 (3), 657 (14), 631 (19)
 beste Teiler 118.8 (6.) 129.0 (12.) 157.3 (20.)
 Trefferlage 1.30 mm rechts, 0.63 mm tief
 Streuwert 2.85, horizontal: 3.34, vertikal: 2.24

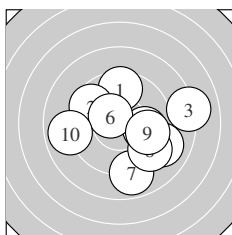
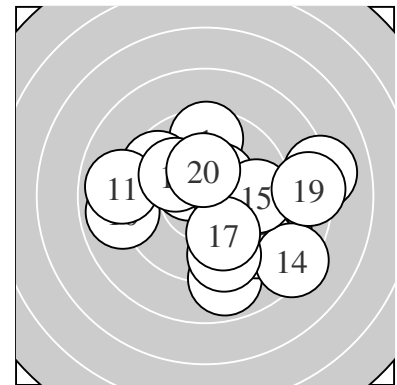

Serie 1:
 9.6 ↑ 9.6 ↖ 8.1 → 9.9 → 9.0 ↘
 10.5 * 8.9 ↓ 9.3 ↘ 9.8 → 8.9 ←
 beste Teiler 118.8 (6.) 261.2 (4.) 299.7 (9.)
 Trefferlage 1.21 mm rechts, 0.49 mm tief
 Streuwert 3.04, horizontal: 3.53, vertikal: 2.46

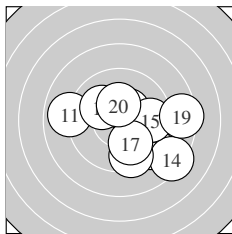

Serie 2:
 8.9 ← 10.4 * 9.3 ↘ 8.3 ↘ 9.7 →
 9.4 ↓ 9.9 ↓ 10.1 ↖ 8.4 → 10.3 *
 beste Teiler 129.0 (12.) 157.3 (20.) 221.4 (18.)
 Trefferlage 1.39 mm rechts, 0.77 mm tief
 Streuwert 2.79, horizontal: 3.33, vertikal: 2.13

Unterschrift des Schützen

Ergebnis: **199.2** (191)
 Serien: 100.3 98.9
 Zähler: 13 6 0 1 0 0 0 0 0 0
 Innenzehner: 7
 weiteste: 907 (20), 443 (9), 374 (6)
 beste Teiler 33.7 (1.) 39.8 (13.) 112.9 (11.)
 Trefferlage 0.65 mm links, 0.69 mm hoch
 Streuwert 2.10, horizontal: 2.73, vertikal: 1.18

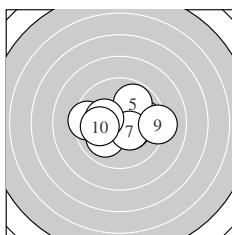
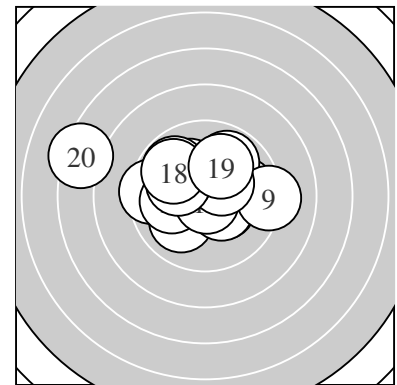

Serie 1:
 10.8 * 10.0 ↙ 10.4 * 9.9 → 9.9 ↗
 9.5 ← 10.4 * 10.2 * 9.2 → 10.0 ←
 beste Teiler 33.7 (1.) 142.8 (7.) 149.5 (3.)
 Trefferlage 0.15 mm rechts, 0.00 mm
 Streuwert 1.93, horizontal: 2.50, vertikal: 1.07

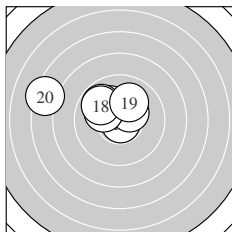

Serie 2:
 10.5 * 10.1 ↘ 10.8 * 10.4 * 9.8 ↖
 10.1 ↘ 10.1 ↘ 9.8 ↖ 10.0 ↗ 7.3 ←
 beste Teiler 39.8 (13.) 112.9 (11.) 145.6 (14.)
 Trefferlage 1.47 mm links, 1.38 mm hoch
 Streuwert 2.09, horizontal: 2.83, vertikal: 0.86

Unterschrift des Schützen

Ergebnis: **180.0** (172)
 Serien: 85.9 94.1
 Zähler: 5 8 4 1 1 1 0 0 0 0
 Innenzehner: 3
 weiteste: 1270 (10), 1133 (5), 914 (1)
 beste Teiler 31.3 (19.) 124.9 (2.) 153.6 (16.)
 Trefferlage 0.17 mm links, 1.38 mm hoch
 Streuwert 4.08, horizontal: 5.08, vertikal: 2.72

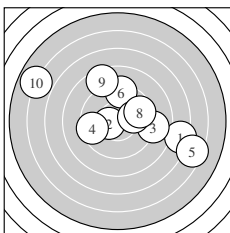
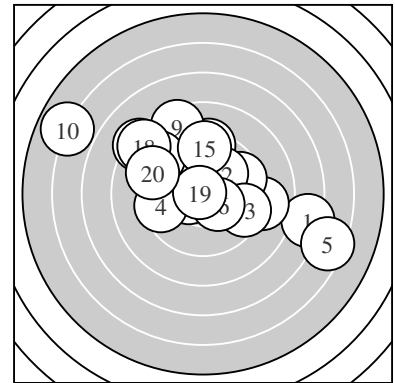

Serie 1:
 7.3 → 10.5 * 8.9 → 9.5 ← 6.4 →
 9.3 ↑ 10.0 → 9.6 → 8.5 ↑ 5.9 ↖
 beste Teiler 124.9 (2.) 231.3 (7.) 338.9 (8.)
 Trefferlage 1.18 mm rechts, 0.85 mm hoch
 Streuwert 5.08, horizontal: 6.37, vertikal: 3.31

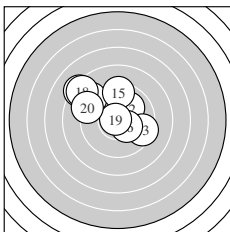

Serie 2:
 9.4 ↖ 10.0 ↗ 9.5 → 9.0 ↖ 9.4 ↑
 10.3 * 8.2 ↖ 8.4 ↖ 10.8 * 9.1 ↖
 beste Teiler 31.3 (19.) 153.6 (16.) 232.2 (12.)
 Trefferlage 1.53 mm links, 1.90 mm hoch
 Streuwert 2.64, horizontal: 3.13, vertikal: 2.02

Unterschrift des Schützen

Ergebnis: **196.0** (186)
 Serien: 98.6 97.4
 Zähler: 9 8 3 0 0 0 0 0 0 0
 Innenzehner: 7
 weiteste: 663 (15), 638 (20), 515 (8)
 beste Teiler 53.0 (18.) 57.4 (6.) 72.9 (9.)
 Trefferlage 0.05 mm rechts, 1.27 mm hoch
 Streuwert 2.26, horizontal: 2.74, vertikal: 1.63

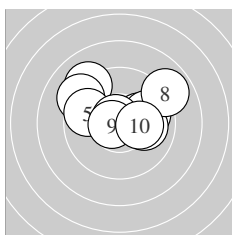
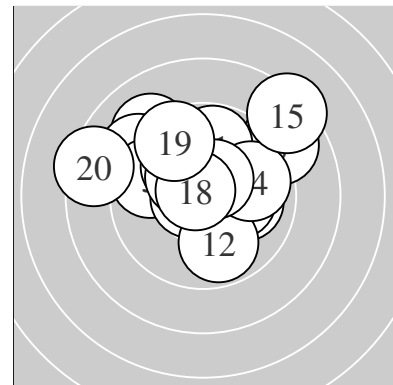

Serie 1:
 9.1 ↘ 10.2 * 9.2 ↖ 9.9 → 9.7 ↙
 10.7 * 10.0 → 8.9 ↗ 10.7 * 10.2 *
 beste Teiler 57.4 (6.) 72.9 (9.) 188.8 (10.)
 Trefferlage 0.21 mm rechts, 1.10 mm hoch
 Streuwert 2.17, horizontal: 2.75, vertikal: 1.35

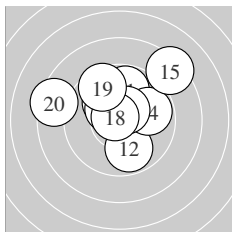

Serie 2:
 9.8 ↑ 9.8 ↓ 10.1 ↘ 9.8 → 8.3 ↗
 10.4 * 10.5 * 10.7 * 9.6 ↖ 8.4 ↙
 beste Teiler 53.0 (18.) 111.5 (17.) 147.1 (16.)
 Trefferlage 0.10 mm links, 1.44 mm hoch
 Streuwert 2.45, horizontal: 2.87, vertikal: 1.93

Unterschrift des Schützen

Ergebnis: **177.1** (168)
 Serien: 89.2 87.9
 Zähler: 2 10 5 1 1 1 0 0 0 0
 Innenzehner: 1
 weiteste: 1351 (14), 1116 (9), 864 (7)
 beste Teiler 164.7 (8.) 219.8 (12.) 278.5 (20.)
 Trefferlage 1.34 mm rechts, 0.34 mm tief
 Streuwert 4.23, horizontal: 5.52, vertikal: 2.31

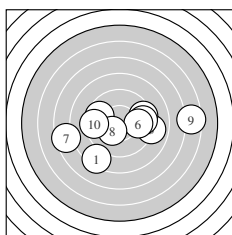
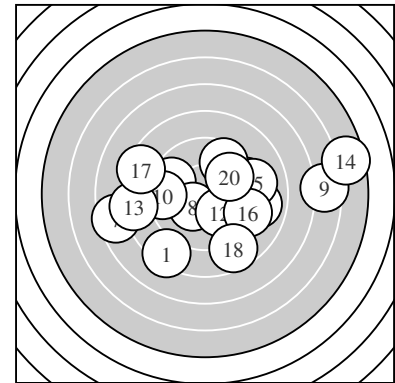

Serie 1:
 8.3 ↙ 9.6 ↖ 8.9 → 9.4 → 9.5 →
 9.8 → 7.5 ← 10.3 * 6.5 → 9.4 ←
 beste Teiler 164.7 (8.) 291.0 (6.) 332.5 (2.)
 Trefferlage 0.61 mm rechts, 0.67 mm tief
 Streuwert 4.26, horizontal: 5.67, vertikal: 2.03

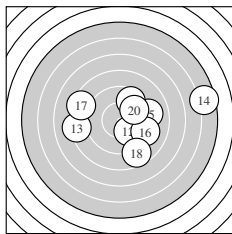

Serie 2:
 9.3 → 10.1 ↘ 8.2 ← 5.5 → 9.1 →
 9.2 → 8.4 ↖ 8.7 ↘ 9.6 ↗ 9.8 ↗
 beste Teiler 219.8 (12.) 278.5 (20.) 343.3 (19.)
 Trefferlage 2.08 mm rechts, 0.01 mm tief
 Streuwert 4.35, horizontal: 5.56, vertikal: 2.64

Unterschrift des Schützen

Ergebnis: **181.9** (174)
 Serien: 94.6 87.3
 Zähler: 6 7 4 2 0 1 0 0 0 0
 Innenzehner: 3
 weiteste: 1268 (14), 959 (16), 859 (3)
 beste Teiler 46.1 (9.) 130.7 (6.) 148.6 (7.)
 Trefferlage 3.56 mm rechts, 0.57 mm hoch
 Streuwert 3.05, horizontal: 4.05, vertikal: 1.50

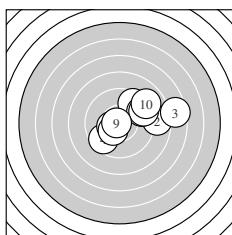
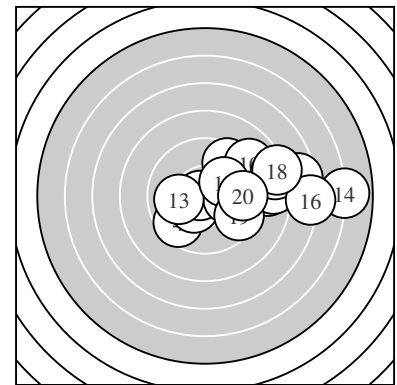

Serie 1:
 9.5 ↗ 8.7 → 7.5 → 9.6 ↙ 9.4 ↗
 10.4 * 10.4 * 9.3 ↗ 10.8 * 9.0 ↗
 beste Teiler 46.1 (9.) 130.7 (6.) 148.6 (7.)
 Trefferlage 2.19 mm rechts, 0.76 mm hoch
 Streuwert 2.75, horizontal: 3.47, vertikal: 1.77

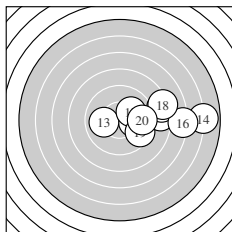

Serie 2:
 8.5 → 10.1 → 10.0 ← 5.9 → 8.3 →
 7.1 → 10.1 ↗ 8.2 → 9.5 ↘ 9.6 →
 beste Teiler 211.0 (12.) 214.4 (17.) 240.0 (13.)
 Trefferlage 4.93 mm rechts, 0.37 mm hoch
 Streuwert 3.15, horizontal: 4.29, vertikal: 1.23

Unterschrift des Schützen

Ergebnis: **186.3** (176)
 Serien: 95.2 91.1
 Zähler: 2 13 4 1 0 0 0 0 0 0
 Innenzehner: 2
 weiteste: 930 (13), 743 (4), 659 (16)
 beste Teiler 105.2 (19.) 178.9 (6.) 251.2 (11.)
 Trefferlage 1.20 mm links, 1.61 mm hoch
 Streuwert 2.94, horizontal: 3.64, vertikal: 2.01

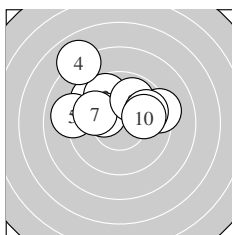
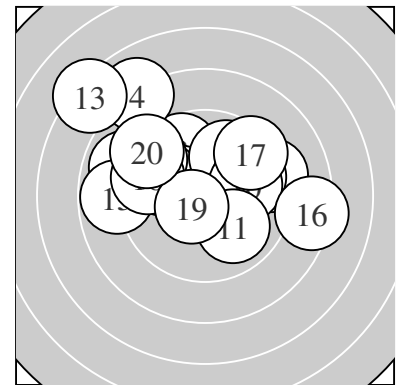

Serie 1:
 9.3 → 9.5 ↘ 9.7 ↘ 8.0 ↘ 9.0 ←
 10.2 * 9.9 ↙ 9.9 ↗ 9.8 → 9.9 →
 beste Teiler 178.9 (6.) 254.9 (10.) 268.8 (8.)
 Trefferlage 0.66 mm links, 1.95 mm hoch
 Streuwert 2.47, horizontal: 3.07, vertikal: 1.67

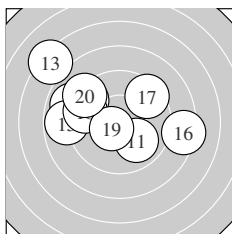

Serie 2:
 9.9 ↘ 8.9 ↙ 7.2 ↘ 9.4 ↘ 8.8 ←
 8.3 → 9.4 ↗ 9.5 ↙ 10.5 * 9.2 ↘
 beste Teiler 105.2 (19.) 251.2 (11.) 367.7 (18.)
 Trefferlage 1.74 mm links, 1.28 mm hoch
 Streuwert 3.42, horizontal: 4.23, vertikal: 2.33

Unterschrift des Schützen

Ergebnis: **199.8** (190)
 Serien: 102.9 96.9
 Zähler: 13 4 3 0 0 0 0 0 0 0
 Innenzehner: 10
 weiteste: 585 (19), 557 (20), 522 (15)
 beste Teiler 20.2 (3.) 32.6 (2.) 45.8 (13.)
 Trefferlage 0.57 mm rechts, 0.56 mm tief
 Streuwert 2.06, horizontal: 2.41, vertikal: 1.63

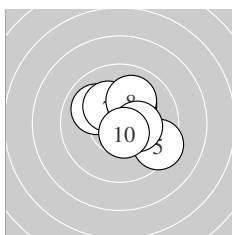
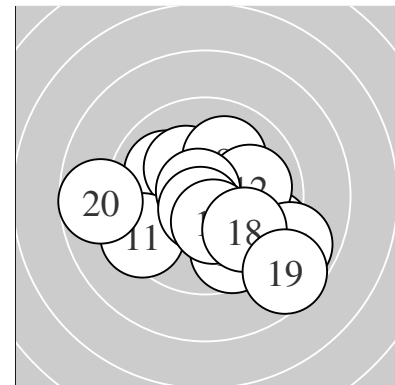

Serie 1:
 10.4 * 10.8 * 10.9 * 10.2 * 9.4 ↘
 10.0 ↖ 10.2 * 10.1 ↗ 10.3 * 10.6 *
 beste Teiler 20.2 (3.) 32.6 (2.) 93.5 (10.)
 Trefferlage 0.59 mm rechts, 0.37 mm hoch
 Streuwert 1.36, horizontal: 1.49, vertikal: 1.22

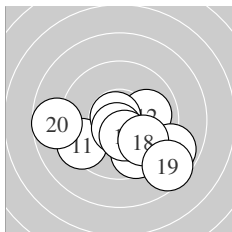

Serie 2:
 9.4 ↙ 10.0 → 10.8 * 10.7 * 8.9 ↘
 9.6 ↓ 10.4 * 9.8 ↘ 8.6 ↘ 8.7 ←
 beste Teiler 45.8 (13.) 74.3 (14.) 143.5 (17.)
 Trefferlage 0.56 mm rechts, 1.50 mm tief
 Streuwert 2.47, horizontal: 3.17, vertikal: 1.46

Unterschrift des Schützen

Ergebnis: **201.1** (194)
 Serien: 98.7 102.4
 Zähler: 15 4 1 0 0 0 0 0 0 0
 Innenzehner: 10
 weiteste: 584 (7), 370 (6), 367 (1)
 beste Teiler 28.8 (17.) 54.1 (15.) 117.3 (10.)
 Trefferlage 0.35 mm rechts, 0.19 mm hoch
 Streuwert 1.82, horizontal: 2.31, vertikal: 1.14

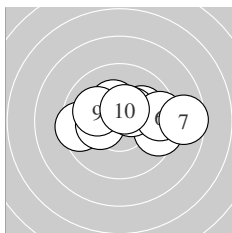
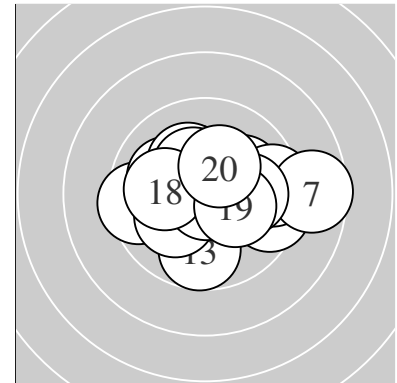

Serie 1:
 9.5 ← 10.1 ↗ 10.2 * 9.5 → 10.4 *
 9.5 → 8.6 → 10.3 * 10.1 ↖ 10.5 *
 beste Teiler 117.3 (10.) 136.0 (5.) 162.6 (8.)
 Trefferlage 0.85 mm rechts, 0.41 mm hoch
 Streuwert 2.17, horizontal: 2.96, vertikal: 0.79

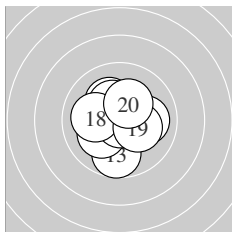

Serie 2:
 10.2 * 10.3 * 9.7 ↓ 10.0 → 10.7 *
 10.1 ↙ 10.8 * 10.1 ← 10.2 * 10.3 *
 beste Teiler 28.8 (17.) 54.1 (15.) 153.4 (12.)
 Trefferlage 0.14 mm links, 0.03 mm tief
 Streuwert 1.41, horizontal: 1.40, vertikal: 1.42

Unterschrift des Schützen

Ergebnis: **170.7** (161)
 Serien: 84.6 86.1
 Zähler: 1 5 9 4 1 0 0 0 0 0
 Innenzehner: 0
 weiteste: 1075 (11), 966 (10), 860 (12)
 beste Teiler 237.6 (17.) 284.3 (15.) 295.3 (16.)
 Trefferlage 1.51 mm rechts, 0.38 mm tief
 Streuwert 4.56, horizontal: 5.82, vertikal: 2.79

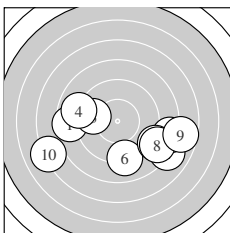
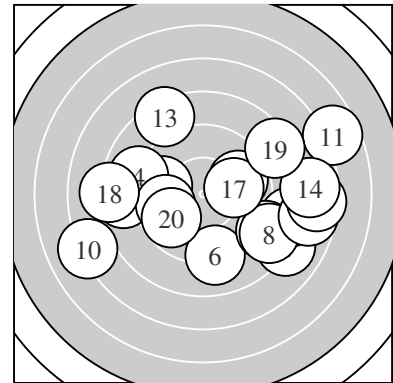

Serie 1:

8.5 ← 8.0 ↘ 9.7 ← 8.9 ← 8.2 →
 9.1 ↓ 8.8 ↘ 8.6 ↘ 7.7 → 7.1 ←

beste Teiler 313.0 (3.) 471.8 (6.) 506.5 (4.)
 Trefferlage 0.87 mm rechts, 2.02 mm tief
 Streuwert 4.53, horizontal: 6.07, vertikal: 2.05

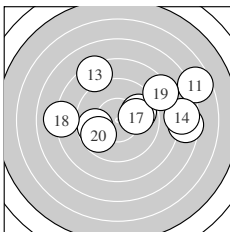

Serie 2:

6.7 → 7.5 → 8.3 ↖ 7.7 → 9.8 →
 9.8 ← 10.0 → 8.1 ← 8.4 → 9.8 ←

beste Teiler 237.6 (17.) 284.3 (15.) 295.3 (16.)
 Trefferlage 2.16 mm rechts, 1.26 mm hoch
 Streuwert 4.46, horizontal: 5.80, vertikal: 2.48

Unterschrift des Schützen

Ergebnis: **192.6** (185)
 Serien: 97.3 95.3
 Zähler: 8 9 3 0 0 0 0 0 0 0
 Innenzehner: 7
 weiteste: 662 (13), 644 (18), 542 (20)
 beste Teiler 13.6 (11.) 111.6 (8.) 175.8 (7.)
 Trefferlage 0.86 mm rechts, 0.06 mm hoch
 Streuwert 2.66, horizontal: 3.52, vertikal: 1.32

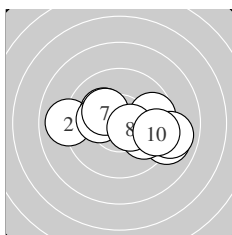
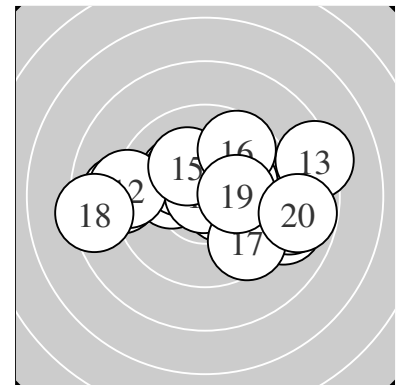

Serie 1:
 9.7 → 9.0 ← 10.2 * 9.0 ↘ 10.2 *
 9.9 ↘ 10.3 * 10.5 * 9.0 → 9.5 →
 beste Teiler 111.6 (8.) 175.8 (7.) 191.0 (3.)
 Trefferlage 0.96 mm rechts, 0.19 mm tief
 Streuwert 2.41, horizontal: 3.25, vertikal: 1.01

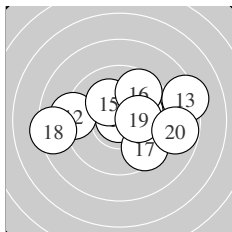

Serie 2:
 10.9 * 9.2 ← 8.3 → 10.1 → 10.2 *
 9.7 ↗ 9.5 ↘ 8.4 ← 10.2 * 8.8 →
 beste Teiler 13.6 (11.) 181.3 (19.) 198.2 (15.)
 Trefferlage 0.76 mm rechts, 0.32 mm hoch
 Streuwert 3.00, horizontal: 3.94, vertikal: 1.58

Unterschrift des Schützen

Ergebnis: **201.6** (191)
 Serien: 102.3 99.3
 Zähler: 12 7 1 0 0 0 0 0 0 0
 Innenzehner: 12
 weiteste: 650 (14), 406 (20), 363 (18)
 beste Teiler 39.2 (5.) 58.7 (7.) 62.3 (11.)
 Trefferlage 0.69 mm links, 0.35 mm tief
 Streuwert 1.81, horizontal: 2.14, vertikal: 1.40

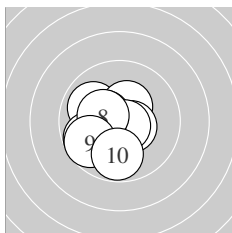
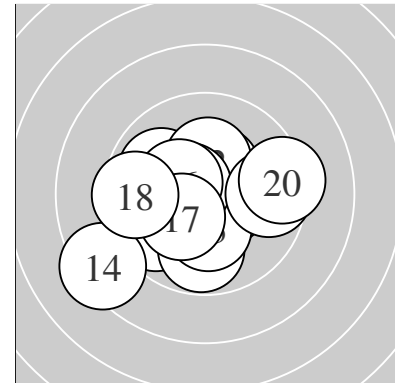

Serie 1:
 9.9 ↘ 10.4 * 10.5 * 9.8 ↙ 10.8 *
 10.4 * 10.7 * 10.3 * 9.7 ↙ 9.8 ↓
 beste Teiler 39.2 (5.) 58.7 (7.) 108.6 (3.)
 Trefferlage 0.85 mm links, 0.38 mm tief
 Streuwert 1.34, horizontal: 1.35, vertikal: 1.32

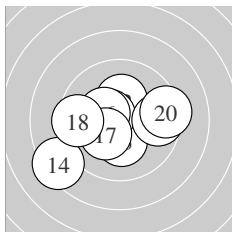

Serie 2:
 10.7 * 10.3 * 10.2 * 8.4 ↙ 10.6 *
 10.4 * 10.3 * 9.5 ← 9.6 → 9.3 →
 beste Teiler 62.3 (11.) 97.0 (15.) 146.4 (16.)
 Trefferlage 0.53 mm links, 0.31 mm tief
 Streuwert 2.25, horizontal: 2.79, vertikal: 1.55

Unterschrift des Schützen

Ergebnis: **197.2** (186)
 Serien: 98.2 99.0
 Zähler: 8 10 2 0 0 0 0 0 0 0
 Innenzehner: 7
 weiteste: 612 (7), 532 (17), 446 (1)
 beste Teiler 34.3 (18.) 92.0 (5.) 117.3 (11.)
 Trefferlage 0.04 mm links, 0.08 mm tief
 Streuwert 2.25, horizontal: 3.00, vertikal: 1.06

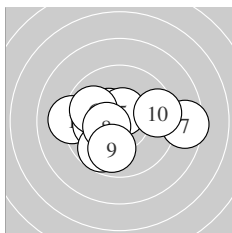
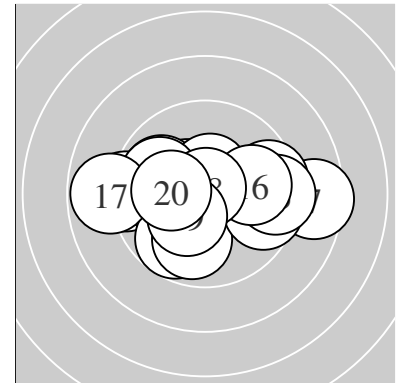

Serie 1:
 9.2 ← 10.4 * 10.1 ← 9.7 ✓ 10.6 *
 9.9 ↖ 8.5 → 10.4 * 9.9 ↓ 9.5 →
 beste Teiler 92.0 (5.) 130.5 (8.) 130.7 (2.)
 Trefferlage 0.37 mm links, 0.24 mm tief
 Streuwert 2.37, horizontal: 3.08, vertikal: 1.32

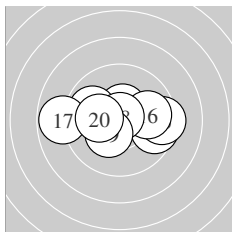

Serie 2:
 10.5 * 9.9 ↖ 9.6 → 9.6 → 9.4 →
 9.9 → 8.8 ← 10.8 * 10.3 * 10.2 *
 beste Teiler 34.3 (18.) 117.3 (11.) 159.9 (19.)
 Trefferlage 0.27 mm rechts, 0.07 mm hoch
 Streuwert 2.21, horizontal: 3.04, vertikal: 0.74

Unterschrift des Schützen

Ergebnis: **179.8** (172)
 Serien: 91.0 88.8
 Zähler: 4 10 3 1 1 1 0 0 0 0
 Innenzehner: 2
 weiteste: 1260 (15), 1108 (9), 940 (18)
 beste Teiler 190.9 (14.) 200.2 (4.) 222.9 (17.)
 Trefferlage 0.38 mm links, 1.92 mm hoch
 Streuwert 3.89, horizontal: 4.98, vertikal: 2.34

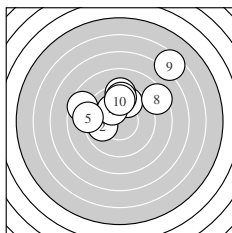
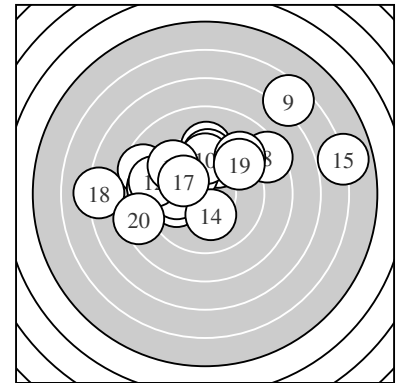

Serie 1:
 8.6 ↖ 9.9 ← 9.7 ↗ 10.2 * 9.1 ←
 9.3 ↑ 9.6 ↑ 8.4 ↘ 6.5 ↗ 9.7 ↑
 beste Teiler 200.2 (4.) 261.0 (2.) 301.0 (3.)
 Trefferlage 0.05 mm rechts, 2.87 mm hoch
 Streuwert 3.30, horizontal: 4.02, vertikal: 2.39

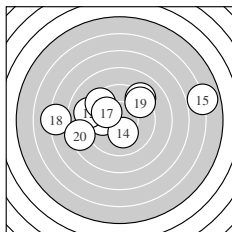

Serie 2:
 10.0 ← 9.1 ← 9.4 ↖ 10.2 * 5.9 →
 9.2 ↗ 10.1 ↖ 7.2 ← 9.3 ↗ 8.4 ←
 beste Teiler 190.9 (14.) 222.9 (17.) 250.0 (11.)
 Trefferlage 0.81 mm links, 0.97 mm hoch
 Streuwert 4.46, horizontal: 5.99, vertikal: 1.96

Unterschrift des Schützen

Ergebnis: **187.6** (177)
 Serien: 89.1 98.5
 Zähler: 6 6 7 1 0 0 0 0 0 0
 Innenzehner: 4
 weiteste: 835 (6), 711 (14), 667 (3)
 beste Teiler 50.9 (11.) 116.2 (20.) 138.5 (12.)
 Trefferlage 0.52 mm links, 0.09 mm hoch
 Streuwert 3.26, horizontal: 4.38, vertikal: 1.44

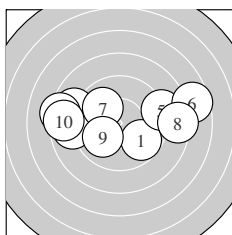
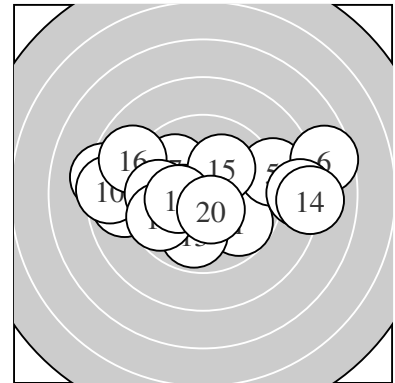

Serie 1:
 9.7 ↘ 8.8 ← 8.3 ← 8.9 ← 9.0 →
 7.6 → 9.9 ↘ 8.4 → 10.0 ↗ 8.5 ←
 beste Teiler 239.5 (9.) 252.6 (7.) 302.0 (1.)
 Trefferlage 0.52 mm links, 0.45 mm hoch
 Streuwert 4.01, horizontal: 5.49, vertikal: 1.42

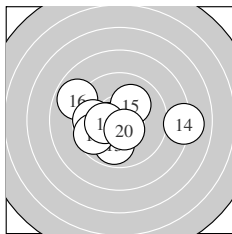

Serie 2:
 10.8 * 10.4 * 9.9 ↓ 8.1 → 10.1 ↗
 8.9 ↘ 9.8 ← 9.7 ↗ 10.3 * 10.5 *
 beste Teiler 50.9 (11.) 116.2 (20.) 138.5 (12.)
 Trefferlage 0.53 mm links, 0.27 mm tief
 Streuwert 2.48, horizontal: 3.21, vertikal: 1.43

Unterschrift des Schützen

Ergebnis: **185.1** (178)
 Serien: 93.5 91.6
 Zähler: 5 9 5 1 0 0 0 0 0 0
 Innenzehner: 3
 weiteste: 1000 (19), 744 (3), 726 (13)
 beste Teiler 138.5 (5.) 184.2 (11.) 191.6 (9.)
 Trefferlage 0.84 mm links, 1.01 mm tief
 Streuwert 3.33, horizontal: 4.12, vertikal: 2.28

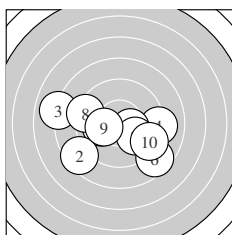
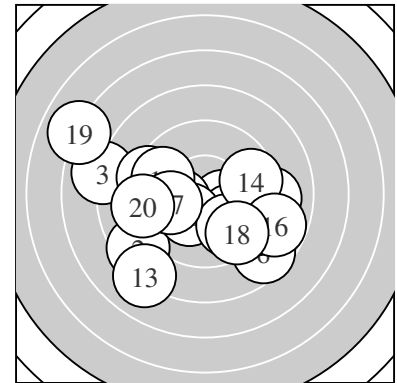

Serie 1:
 10.1 ← 8.5 ↙ 8.0 ← 9.1 → 10.4 *
 8.6 ↘ 10.0 ↘ 9.3 ← 10.2 * 9.3 ↘
 beste Teiler 138.5 (5.) 191.6 (9.) 223.9 (1.)
 Trefferlage 0.47 mm links, 1.07 mm tief
 Streuwert 3.22, horizontal: 4.15, vertikal: 1.88

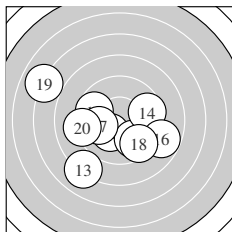

Serie 2:
 10.2 * 9.8 ↘ 8.0 ↙ 9.6 → 9.7 ←
 8.8 ↘ 9.9 ← 9.5 ↘ 7.0 ← 9.1 ←
 beste Teiler 184.2 (11.) 252.9 (17.) 277.2 (12.)
 Trefferlage 1.21 mm links, 0.95 mm tief
 Streuwert 3.58, horizontal: 4.27, vertikal: 2.73

Unterschrift des Schützen

Ergebnis: **163.6** (152)
 Serien: 84.6 79.0
 Zähler: 2 6 4 3 2 1 2 0 0 0
 Innenzehner: 2
 weiteste: 1530 (1), 1515 (11), 1256 (19)
 beste Teiler 121.8 (20.) 198.8 (18.) 290.1 (8.)
 Trefferlage 2.51 mm links, 0.96 mm hoch
 Streuwert 5.51, horizontal: 7.53, vertikal: 1.98

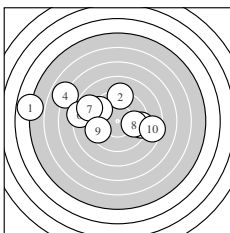
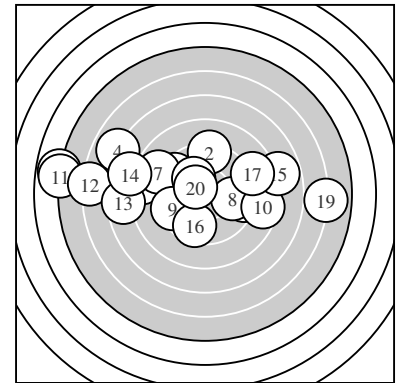

Serie 1:
 4.8 ← 9.2 ↑ 9.5 ↖ 6.9 ↖ 9.3 →
 8.3 ← 8.8 ↖ 9.8 → 9.5 ← 8.5 →
 beste Teiler 290.1 (8.) 370.6 (9.) 373.3 (3.)
 Trefferlage 2.87 mm links, 1.26 mm hoch
 Streuwert 4.84, horizontal: 6.47, vertikal: 2.22

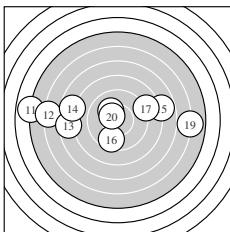

Serie 2:
 4.9 ← 6.1 ← 7.5 ← 7.7 ← 7.8 →
 9.6 ↓ 8.8 → 10.2 * 5.9 → 10.5 *
 beste Teiler 121.8 (20.) 198.8 (18.) 344.3 (16.)
 Trefferlage 2.15 mm links, 0.67 mm hoch
 Streuwert 6.36, horizontal: 8.81, vertikal: 1.77

Unterschrift des Schützen

Ergebnis: **168.6** (160)
 Serien: 91.3 77.3
 Zähler: 4 4 5 4 2 0 1 0 0 0
 Innenzehner: 3
 weiteste: 1570 (19), 1182 (16), 1018 (15)
 beste Teiler 130.3 (6.) 142.0 (1.) 164.1 (10.)
 Trefferlage 1.10 mm rechts, 0.63 mm hoch
 Streuwert 5.21, horizontal: 6.95, vertikal: 2.45

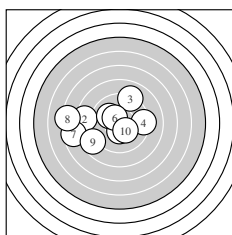
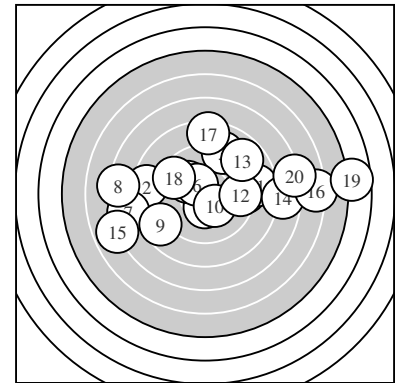

Serie 1:
 10.4 * 8.4 ← 9.0 ↗ 9.2 → 10.1 ↘
 10.4 * 7.6 ← 7.2 ← 8.7 ↙ 10.3 *
 beste Teiler 130.3 (6.) 142.0 (1.) 164.1 (10.)
 Trefferlage 2.39 mm links, 0.06 mm hoch
 Streuwert 3.53, horizontal: 4.51, vertikal: 2.14

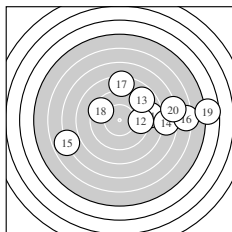

Serie 2:
 8.7 → 9.4 → 8.8 ↗ 7.6 → 6.9 ←
 6.2 → 8.4 ↑ 9.5 ↘ 4.7 → 7.1 →
 beste Teiler 373.0 (18.) 377.1 (12.) 535.7 (13.)
 Trefferlage 4.61 mm rechts, 1.19 mm hoch
 Streuwert 5.56, horizontal: 7.37, vertikal: 2.73

Unterschrift des Schützen

Ergebnis: **191.8** (184)
 Serien: 95.1 96.7
 Zähler: 7 11 1 1 0 0 0 0 0 0
 Innenzehner: 5
 weiteste: 791 (5), 614 (6), 500 (18)
 beste Teiler 103.8 (14.) 155.2 (11.) 169.0 (20.)
 Trefferlage 0.61 mm rechts, 0.00 mm
 Streuwert 2.73, horizontal: 3.42, vertikal: 1.77

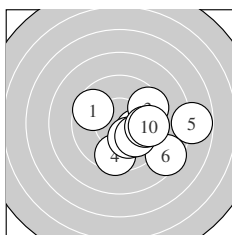
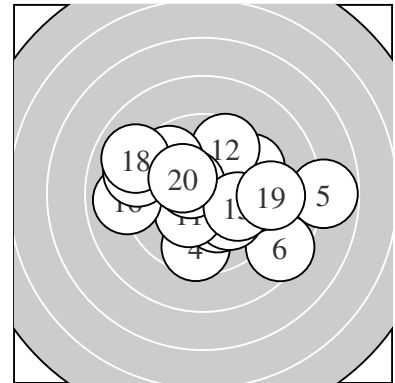

Serie 1:
 9.7 ↘ 10.2 * 9.5 ↗ 9.6 ↓ 7.8 →
 8.5 ↘ 10.2 * 10.1 ↘ 9.8 → 9.7 →
 beste Teiler 184.7 (7.) 195.3 (2.) 223.6 (8.)
 Trefferlage 2.32 mm rechts, 0.82 mm tief
 Streuwert 2.42, horizontal: 2.94, vertikal: 1.75

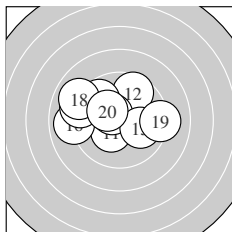

Serie 2:
 10.3 * 9.6 ↗ 9.7 ↘ 10.5 * 10.0 →
 9.0 ← 9.1 ↘ 9.0 ↘ 9.2 → 10.3 *
 beste Teiler 103.8 (14.) 155.2 (11.) 169.0 (20.)
 Trefferlage 1.08 mm links, 0.80 mm hoch
 Streuwert 2.42, horizontal: 3.10, vertikal: 1.44

Unterschrift des Schützen

Ergebnis: **187.6** (180)
 Serien: 92.6 95.0
 Zähler: 9 4 6 0 1 0 0 0 0 0
 Innenzehner: 6
 weiteste: 1165 (8), 745 (1), 713 (7)
 beste Teiler 27.8 (20.) 64.5 (9.) 94.6 (10.)
 Trefferlage 1.99 mm rechts, 0.75 mm tief
 Streuwert 3.16, horizontal: 4.00, vertikal: 2.00

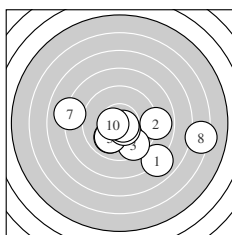
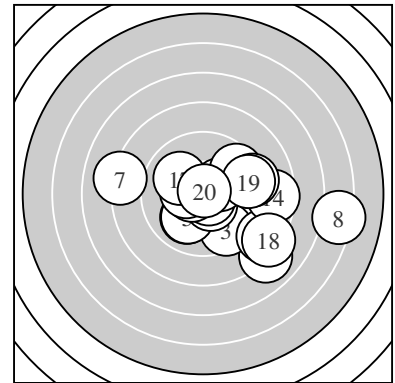

Serie 1:
 8.0 ↘ 8.9 → 9.5 ↘ 10.0 ✓ 10.0 ✓
 10.5 * 8.1 ← 6.3 → 10.7 * 10.6 *
 beste Teiler 64.5 (9.) 94.6 (10.) 109.4 (6.)
 Trefferlage 1.43 mm rechts, 1.42 mm tief
 Streuwert 3.76, horizontal: 4.98, vertikal: 1.84

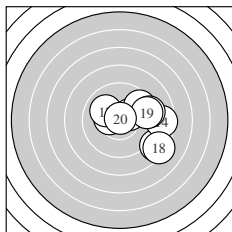

Serie 2:
 10.3 * 8.5 ↘ 10.4 * 8.6 → 9.6 ↗
 9.2 → 10.0 ↖ 8.2 ↘ 9.4 → 10.8 *
 beste Teiler 27.8 (20.) 142.2 (13.) 160.2 (11.)
 Trefferlage 2.54 mm rechts, 0.09 mm tief
 Streuwert 2.48, horizontal: 2.87, vertikal: 2.02

Unterschrift des Schützen

Ergebnis: **189.7** (181)
 Serien: 96.2 93.5
 Zähler: 7 8 4 1 0 0 0 0 0 0
 Innenzehner: 5
 weiteste: 908 (6), 648 (16), 621 (12)
 beste Teiler 45.3 (4.) 78.4 (7.) 113.0 (8.)
 Trefferlage 0.81 mm links, 0.54 mm hoch
 Streuwert 3.01, horizontal: 3.94, vertikal: 1.61

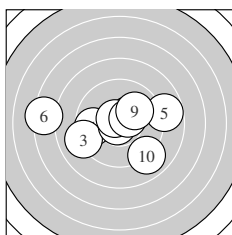
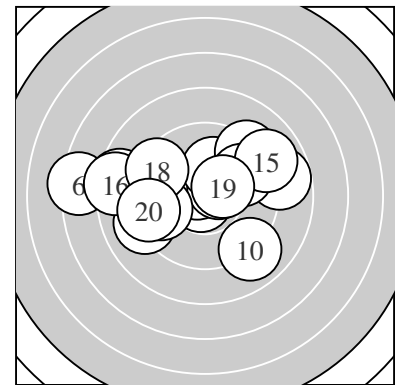

Serie 1:
 9.7 ← 10.4 * 9.1 ← 10.8 * 8.8 →
 7.3 ← 10.6 * 10.5 * 10.0 ↗ 9.0 ↘
 beste Teiler 45.3 (4.) 78.4 (7.) 113.0 (8.)
 Trefferlage 0.49 mm links, 0.08 mm tief
 Streuwert 3.13, horizontal: 4.11, vertikal: 1.65

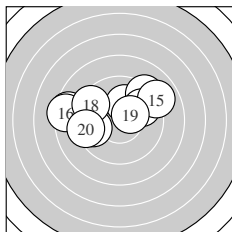

Serie 2:
 10.1 ↑ 8.5 ← 9.2 ↗ 9.7 ↗ 8.9 ↗
 8.4 ← 9.6 ← 9.4 ↖ 10.4 * 9.3 ←
 beste Teiler 143.5 (19.) 206.0 (11.) 303.1 (14.)
 Trefferlage 1.13 mm links, 1.17 mm hoch
 Streuwert 2.95, horizontal: 3.95, vertikal: 1.36

Unterschrift des Schützen

Ergebnis: **181.5** (175)
 Serien: 90.5 91.0
 Zähler: 4 11 2 2 1 0 0 0 0 0
 Innenzehner: 1
 weiteste: 1167 (12), 926 (2), 882 (13)
 beste Teiler 178.8 (14.) 217.4 (16.) 219.2 (7.)
 Trefferlage 0.23 mm rechts, 2.16 mm hoch
 Streuwert 3.53, horizontal: 4.76, vertikal: 1.51

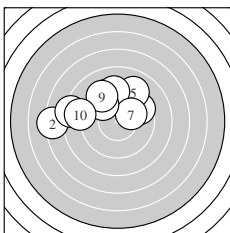
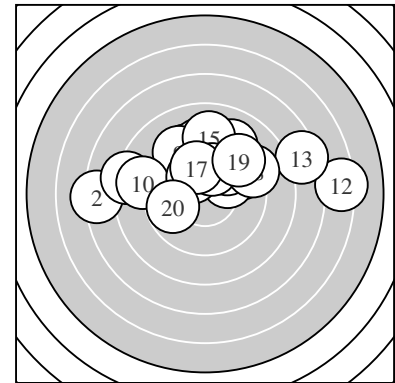

Serie 1:
 9.5 ↗ 7.2 ← 9.3 ↖ 8.2 ← 9.1 ↗
 9.3 ↑ 10.1 ↗ 9.7 ↖ 9.3 ↖ 8.8 ←
 beste Teiler 219.2 (7.) 315.2 (8.) 359.5 (1.)
 Trefferlage 2.04 mm links, 2.28 mm hoch
 Streuwert 3.07, horizontal: 4.05, vertikal: 1.55

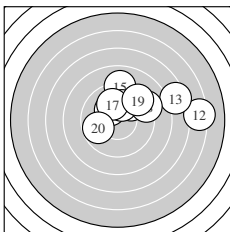

Serie 2:
 9.8 ↗ 6.3 → 7.4 → 10.2 * 9.0 ↑
 10.1 ↑ 10.0 ↖ 9.1 → 9.3 ↗ 9.8 ←
 beste Teiler 178.8 (14.) 217.4 (16.) 236.5 (17.)
 Trefferlage 2.51 mm rechts, 2.03 mm hoch
 Streuwert 3.34, horizontal: 4.46, vertikal: 1.54

Unterschrift des Schützen

Ergebnis: **201.0** (192)
 Serien: 98.8 102.2
 Zähler: 14 4 2 0 0 0 0 0 0 0
 Innenzehner: 10
 weiteste: 645 (8), 529 (7), 412 (18)
 beste Teiler 29.0 (15.) 35.2 (13.) 95.6 (20.)
 Trefferlage 0.31 mm rechts, 0.44 mm hoch
 Streuwert 1.95, horizontal: 2.59, vertikal: 0.92

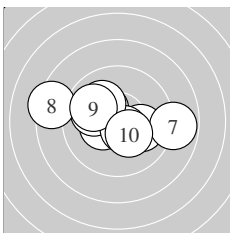
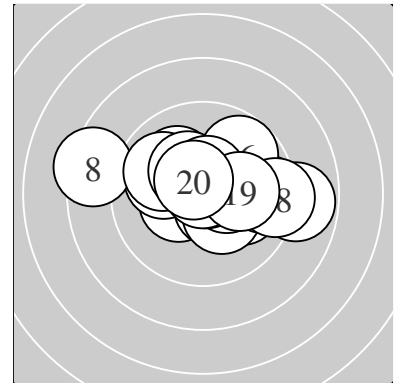

Serie 1:
 10.3 * 10.0 → 10.4 * 10.0 ← 10.6 *
 10.1 ↘ 8.8 → 8.4 ← 9.9 ↘ 10.3 *
 beste Teiler 96.2 (5.) 147.0 (3.) 158.5 (10.)
 Trefferlage 0.57 mm links, 0.29 mm hoch
 Streuwert 2.32, horizontal: 3.09, vertikal: 1.09

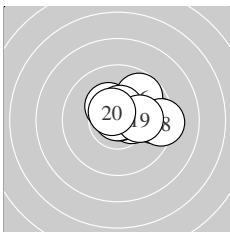

Serie 2:
 10.4 * 10.3 * 10.8 * 9.6 → 10.8 *
 9.8 ↗ 10.5 * 9.3 → 10.1 → 10.6 *
 beste Teiler 29.0 (15.) 35.2 (13.) 95.6 (20.)
 Trefferlage 1.20 mm rechts, 0.59 mm hoch
 Streuwert 1.31, horizontal: 1.69, vertikal: 0.75

Unterschrift des Schützen

Ergebnis: **190.4** (184)
 Serien: 93.8 96.6
 Zähler: 10 6 2 2 0 0 0 0 0 0
 Innenzehner: 5
 weiteste: 953 (19), 829 (4), 593 (13)
 beste Teiler 66.4 (15.) 94.3 (12.) 119.5 (17.)
 Trefferlage 1.38 mm links, 1.07 mm tief
 Streuwert 2.81, horizontal: 3.70, vertikal: 1.46

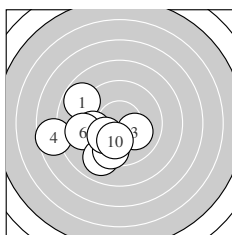
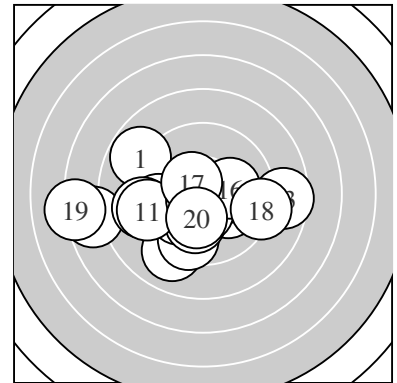

Serie 1:
 8.8 ↘ 9.6 ← 10.1 ↘ 7.6 ← 10.0 ↙
 9.1 ← 9.0 ↙ 9.5 ↙ 10.0 ↗ 10.1 ↘
 beste Teiler 212.1 (3.) 220.7 (10.) 231.8 (9.)
 Trefferlage 2.54 mm links, 1.51 mm tief
 Streuwert 2.33, horizontal: 2.74, vertikal: 1.84

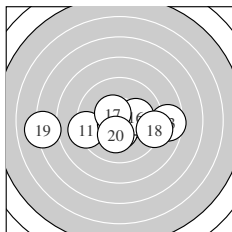

Serie 2:
 9.2 ← 10.6 * 8.6 → 10.4 * 10.7 *
 10.1 → 10.5 * 9.2 → 7.1 ← 10.2 *
 beste Teiler 66.4 (15.) 94.3 (12.) 119.5 (17.)
 Trefferlage 0.22 mm links, 0.63 mm tief
 Streuwert 3.09, horizontal: 4.29, vertikal: 0.83

Unterschrift des Schützen

Ergebnis: **159.9** (152)
 Serien: 79.4 80.5
 Zähler: 3 4 8 1 1 1 1 0 0 0
 Innenzehner: 3
 weiteste: 2525 (15), 1505 (2), 1486 (4)
 beste Teiler 125.0 (18.) 129.2 (10.) 146.8 (19.)
 Trefferlage 1.86 mm rechts, 0.60 mm hoch
 Streuwert 6.53, horizontal: 8.69, vertikal: 3.15

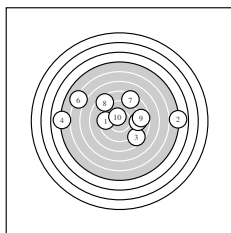
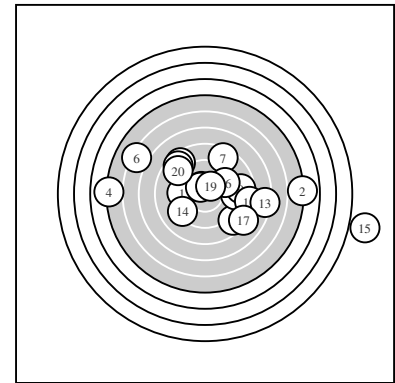

Serie 1:
 9.5 ← 4.9 → 8.6 ↘ 5.0 ← 9.1 →
 6.2 ↖ 8.5 ↗ 8.5 ↖ 8.7 → 10.4 *
 beste Teiler 129.2 (10.) 358.4 (1.) 471.2 (5.)
 Trefferlage 0.10 mm links, 1.47 mm hoch
 Streuwert 6.45, horizontal: 8.60, vertikal: 3.04

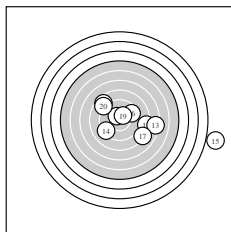

Serie 2:
 8.2 → 8.6 ↖ 7.2 → 9.2 ↙ 0.0 →
 9.5 ↗ 8.1 ↘ 10.5 * 10.4 * 8.8 ↖
 beste Teiler 125.0 (18.) 146.8 (19.) 355.6 (16.)
 Trefferlage 3.82 mm rechts, 0.25 mm tief
 Streuwert 6.59, horizontal: 8.76, vertikal: 3.18

Unterschrift des Schützen

Ergebnis: **189.8** (182)
 Serien: 96.9 92.9
 Zähler: 7 9 3 1 0 0 0 0 0 0
 Innenzehner: 7
 weiteste: 806 (10), 745 (14), 739 (18)
 beste Teiler 72.8 (2.) 97.7 (20.) 120.3 (8.)
 Trefferlage 0.03 mm rechts, 0.40 mm tief
 Streuwert 3.11, horizontal: 4.13, vertikal: 1.50

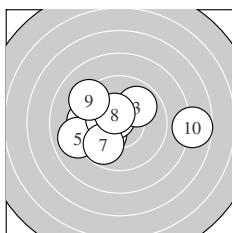
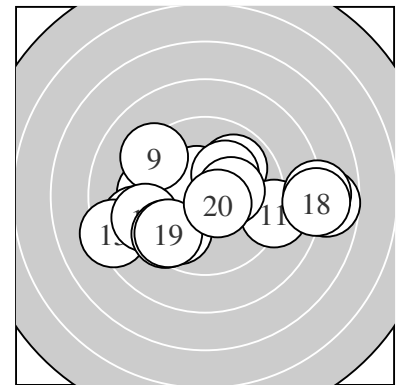

Serie 1:
 10.2 * 10.7 * 9.9 ↗ 9.5 ← 9.0 ←
 10.3 * 9.8 ↙ 10.5 * 9.3 ↘ 7.7 →
 beste Teiler 72.8 (2.) 120.3 (8.) 157.0 (6.)
 Trefferlage 0.74 mm links, 0.10 mm hoch
 Streuwert 2.77, horizontal: 3.60, vertikal: 1.53

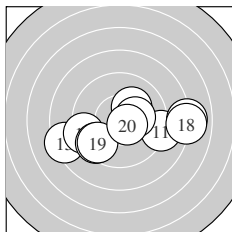

Serie 2:
 9.1 → 10.2 * 10.3 * 8.0 → 8.3 ←
 9.3 ← 9.5 ↙ 8.0 → 9.6 ↘ 10.6 *
 beste Teiler 97.7 (20.) 175.1 (13.) 195.2 (12.)
 Trefferlage 0.81 mm rechts, 0.91 mm tief
 Streuwert 3.43, horizontal: 4.66, vertikal: 1.35

Unterschrift des Schützen

Ergebnis: **199.0** (192)
 Serien: 99.4 99.6
 Zähler: 14 4 2 0 0 0 0 0 0 0
 Innenzehner: 8
 weiteste: 545 (5), 533 (11), 498 (15)
 beste Teiler 33.6 (19.) 60.6 (9.) 91.2 (16.)
 Trefferlage 0.60 mm links, 0.23 mm hoch
 Streuwert 2.06, horizontal: 2.76, vertikal: 0.94

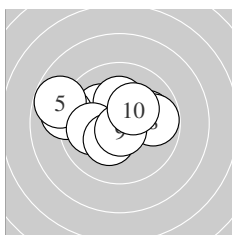
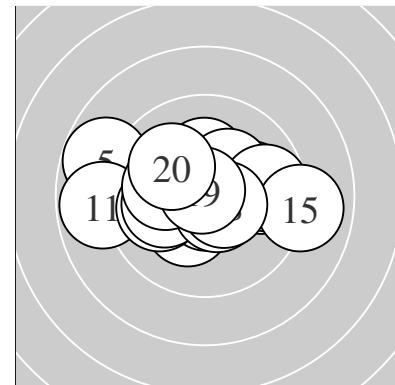

Serie 1:
 10.2 * 9.1 ← 10.2 * 10.0 → 8.8 ↖
 10.0 ← 10.3 * 9.8 → 10.7 * 10.3 *
 beste Teiler 60.6 (9.) 167.2 (7.) 171.1 (10.)
 Trefferlage 0.81 mm links, 0.52 mm hoch
 Streuwert 2.05, horizontal: 2.69, vertikal: 1.08

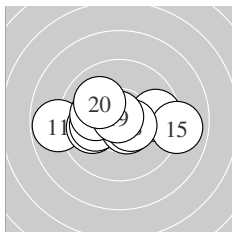

Serie 2:
 8.8 ← 10.0 ← 10.1 ← 9.7 → 9.0 →
 10.6 * 10.1 ← 10.5 * 10.8 * 10.0 ↘
 beste Teiler 33.6 (19.) 91.2 (16.) 107.8 (18.)
 Trefferlage 0.40 mm links, 0.05 mm tief
 Streuwert 2.16, horizontal: 2.97, vertikal: 0.72

 Unterschrift des Schützen

Ergebnis: **0.0** (0)_{DNS}

Serien:

Zähler: 0 0 0 0 0 0 0 0 0 0

Innenzehner: 0

weiteste:

beste Teiler – Schütze ist nicht zum Wettkampf angetreten

Trefferlage 0.00 mm , 0.00 mm

Streuwert

Unterschrift des Schützen

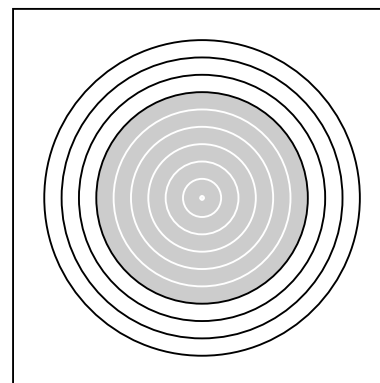

Ergebnis: **166.7** (160)
 Serien: 83.6 83.1
 Zähler: 2 6 6 4 1 0 1 0 0 0
 Innenzehner: 0
 weiteste: 1696 (2), 1204 (20), 993 (6)
 beste Teiler 215.5 (1.) 232.7 (9.) 325.4 (5.)
 Trefferlage 3.15 mm rechts, 3.01 mm hoch
 Streuwert 4.37, horizontal: 5.91, vertikal: 1.81

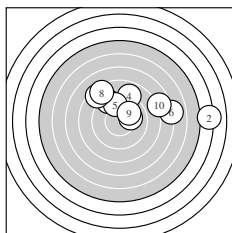
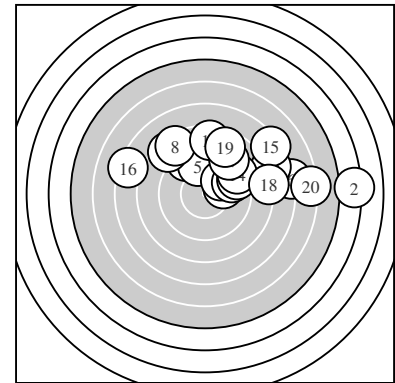

Serie 1:
 10.1 → 4.2 → 9.2 ↘ 8.9 ↗ 9.7 ↖
 7.0 → 8.4 ↘ 8.4 ↘ 10.0 ↗ 7.7 →
 beste Teiler 215.5 (1.) 232.7 (9.) 325.4 (5.)
 Trefferlage 2.92 mm rechts, 2.94 mm hoch
 Streuwert 4.87, horizontal: 6.66, vertikal: 1.75

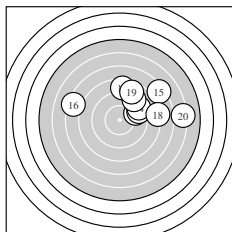

Serie 2:
 8.5 ↑ 9.6 → 9.4 → 9.2 → 7.3 ↗
 7.3 ↖ 9.1 ↗ 8.0 → 8.6 ↗ 6.1 →
 beste Teiler 328.3 (12.) 396.0 (13.) 429.5 (14.)
 Trefferlage 3.37 mm rechts, 3.07 mm hoch
 Streuwert 4.07, horizontal: 5.41, vertikal: 1.97

Unterschrift des Schützen

Ergebnis: **182.2** (174)
 Serien: 90.7 91.5
 Zähler: 5 6 7 2 0 0 0 0 0 0
 Innenzehner: 5
 weiteste: 971 (11), 871 (1), 711 (2)
 beste Teiler 88.0 (20.) 96.3 (19.) 171.1 (8.)
 Trefferlage 3.62 mm rechts, 0.02 mm hoch
 Streuwert 2.75, horizontal: 3.45, vertikal: 1.81

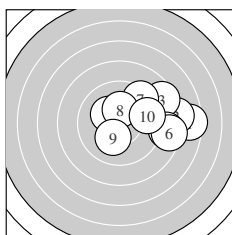
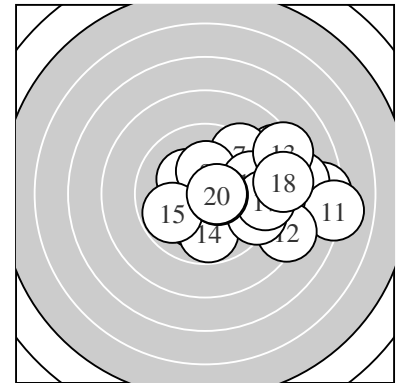

Serie 1:
 7.5 → 8.1 → 8.5 ↗ 10.2 * 8.6 →
 8.4 → 9.4 ↗ 10.3 * 10.2 * 9.5 →
 beste Teiler 171.1 (8.) 177.8 (4.) 195.0 (9.)
 Trefferlage 3.69 mm rechts, 0.69 mm hoch
 Streuwert 2.73, horizontal: 3.50, vertikal: 1.64

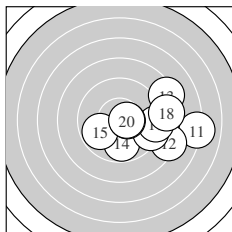

Serie 2:
 7.1 → 8.3 ↘ 8.3 ↗ 9.8 ↓ 9.8 ↖
 9.3 ↘ 9.1 → 8.6 → 10.6 * 10.6 *
 beste Teiler 88.0 (20.) 96.3 (19.) 281.8 (15.)
 Trefferlage 3.54 mm rechts, 0.64 mm tief
 Streuwert 2.83, horizontal: 3.59, vertikal: 1.79

Unterschrift des Schützen

Ergebnis: **194.4** (186)
 Serien: 99.2 95.2
 Zähler: 10 6 4 0 0 0 0 0 0 0
 Innenzehner: 7
 weiteste: 741 (5), 701 (15), 627 (17)
 beste Teiler 61.9 (10.) 130.8 (20.) 132.8 (2.)
 Trefferlage 0.52 mm links, 0.73 mm hoch
 Streuwert 2.54, horizontal: 3.31, vertikal: 1.39

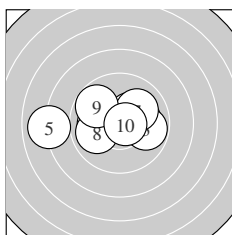
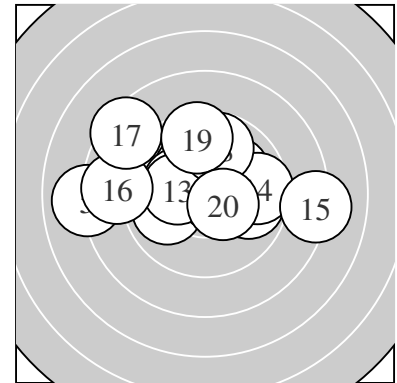

Serie 1:
 10.1 → 10.4 * 9.8 → 10.1 ← 8.0 ←
 10.4 * 10.0 ↗ 9.9 ← 9.8 ↘ 10.7 *
 beste Teiler 61.9 (10.) 132.8 (2.) 145.0 (6.)
 Trefferlage 0.72 mm links, 0.27 mm hoch
 Streuwert 2.25, horizontal: 3.06, vertikal: 0.87

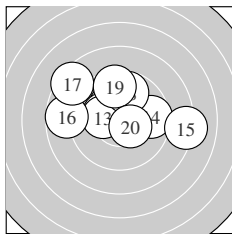

Serie 2:
 10.2 * 10.2 * 10.3 * 9.6 → 8.1 →
 8.7 ← 8.4 ↘ 9.8 ↑ 9.5 ↑ 10.4 *
 beste Teiler 130.8 (20.) 175.9 (13.) 178.6 (12.)
 Trefferlage 0.31 mm links, 1.20 mm hoch
 Streuwert 2.87, horizontal: 3.69, vertikal: 1.68

Unterschrift des Schützen

Ergebnis: **186.3** (176)
 Serien: 95.0 91.3
 Zähler: 5 7 7 1 0 0 0 0 0 0
 Innenzehner: 5
 weiteste: 832 (5), 687 (15), 601 (10)
 beste Teiler 40.4 (7.) 101.4 (11.) 134.5 (1.)
 Trefferlage 1.07 mm links, 0.25 mm tief
 Streuwert 3.23, horizontal: 4.25, vertikal: 1.67

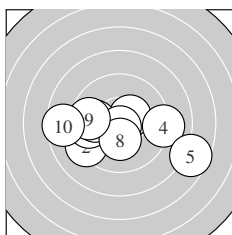
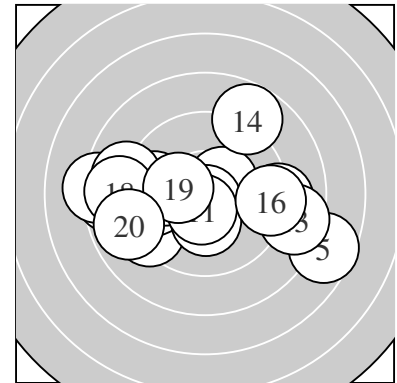

Serie 1:
 10.4 * 9.2 ↙ 9.6 ← 9.1 → 7.6 ↘
 9.9 ← 10.8 * 10.3 * 9.6 ← 8.5 ←
 beste Teiler 40.4 (7.) 134.5 (1.) 172.1 (8.)
 Trefferlage 0.51 mm links, 0.74 mm tief
 Streuwert 3.08, horizontal: 4.14, vertikal: 1.35

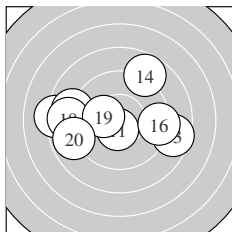

Serie 2:
 10.5 * 9.0 ← 8.6 → 8.8 ↗ 8.2 ←
 9.3 → 8.9 ← 8.8 ← 10.3 * 8.9 ←
 beste Teiler 101.4 (11.) 175.3 (19.) 422.0 (16.)
 Trefferlage 1.63 mm links, 0.24 mm hoch
 Streuwert 3.45, horizontal: 4.51, vertikal: 1.88

Unterschrift des Schützen

Ergebnis: **191.5** (181)
 Serien: 94.0 97.5
 Zähler: 6 10 3 1 0 0 0 0 0 0
 Innenzehner: 5
 weiteste: 954 (8), 611 (11), 543 (18)
 beste Teiler 53.8 (12.) 90.1 (4.) 95.5 (16.)
 Trefferlage 0.12 mm links, 1.55 mm tief
 Streuwert 2.68, horizontal: 3.53, vertikal: 1.36

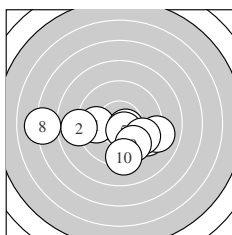
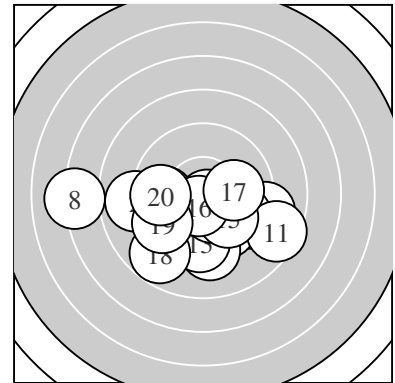

Serie 1:
 9.8 ← 8.9 ← 9.4 ↘ 10.6 * 10.5 *
 9.0 → 9.7 ↘ 7.1 ← 9.7 ↘ 9.3 ↓
 beste Teiler 90.1 (4.) 101.5 (5.) 288.6 (1.)
 Trefferlage 0.31 mm links, 1.39 mm tief
 Streuwert 3.18, horizontal: 4.32, vertikal: 1.23

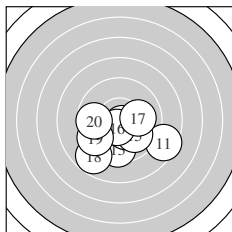

Serie 2:
 8.5 ↘ 10.7 * 9.5 ↓ 10.3 * 9.9 ↘
 10.6 * 10.0 → 8.8 ↙ 9.5 ↙ 9.7 ←
 beste Teiler 53.8 (12.) 95.5 (16.) 155.1 (14.)
 Trefferlage 0.06 mm rechts, 1.71 mm tief
 Streuwert 2.23, horizontal: 2.76, vertikal: 1.52

Unterschrift des Schützen

Ergebnis: **196.0** (186)
 Serien: 97.3 98.7
 Zähler: 8 10 2 0 0 0 0 0 0 0
 Innenzehner: 4
 weiteste: 584 (10), 537 (3), 401 (12)
 beste Teiler 63.5 (6.) 95.7 (16.) 177.1 (4.)
 Trefferlage 0.79 mm rechts, 0.73 mm tief
 Streuwert 2.13, horizontal: 2.84, vertikal: 1.01

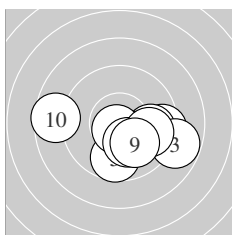
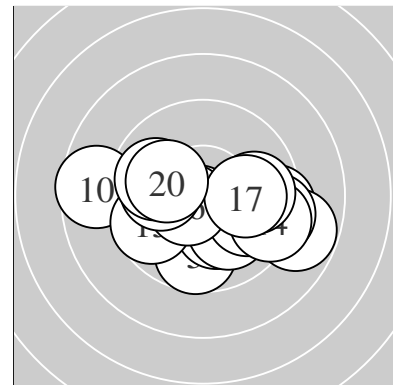

Serie 1:
 9.4 → 9.8 → 8.8 → 10.2 * 9.7 ↓
 10.7 * 10.2 * 9.8 → 10.1 ↘ 8.6 ←
 beste Teiler 63.5 (6.) 177.1 (4.) 188.3 (7.)
 Trefferlage 1.13 mm rechts, 1.16 mm tief
 Streuwert 2.24, horizontal: 3.00, vertikal: 1.00

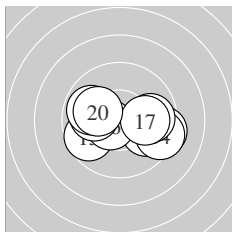

Serie 2:
 9.9 ↘ 9.3 → 9.7 ← 9.4 → 9.8 →
 10.6 * 10.0 → 10.0 ← 9.9 ← 10.1 ←
 beste Teiler 95.7 (16.) 213.5 (20.) 232.0 (17.)
 Trefferlage 0.45 mm rechts, 0.30 mm tief
 Streuwert 2.07, horizontal: 2.79, vertikal: 0.87

Unterschrift des Schützen

Ergebnis: **187.0** (175)
 Serien: 95.7 91.3
 Zähler: 5 8 5 1 1 0 0 0 0 0
 Innenzehner: 4
 weiteste: 1066 (18), 986 (15), 600 (4)
 beste Teiler 15.2 (7.) 40.6 (19.) 109.6 (6.)
 Trefferlage 2.21 mm rechts, 1.31 mm tief
 Streuwert 2.98, horizontal: 3.94, vertikal: 1.48

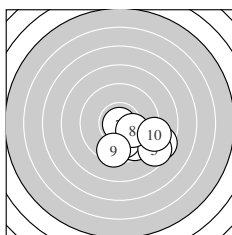
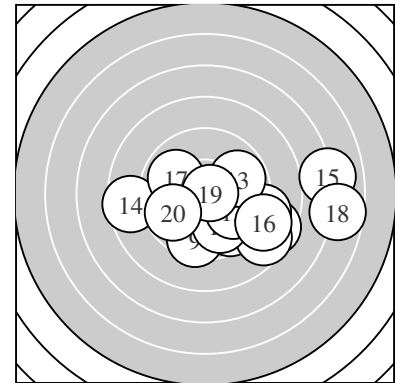

Serie 1:
 9.6 ↘ 8.8 ↘ 10.0 ↓ 8.6 ↘ 8.6 ↘
 10.5 * 10.9 * 10.2 * 9.5 ↓ 9.0 ↘
 beste Teiler 15.2 (7.) 109.6 (6.) 197.4 (8.)
 Trefferlage 2.36 mm rechts, 2.03 mm tief
 Streuwert 1.83, horizontal: 2.32, vertikal: 1.14

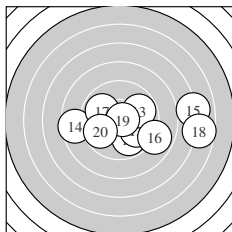

Serie 2:
 9.9 ↘ 9.9 ↘ 9.8 ↗ 8.6 ← 7.0 →
 8.9 ↘ 9.9 ↖ 6.7 → 10.8 * 9.8 ↖
 beste Teiler 40.6 (19.) 261.8 (12.) 264.4 (17.)
 Trefferlage 2.06 mm rechts, 0.58 mm tief
 Streuwert 3.85, horizontal: 5.24, vertikal: 1.47

Unterschrift des Schützen

Ergebnis: **185.4** (175)
 Serien: 92.6 92.8
 Zähler: 7 6 4 1 2 0 0 0 0 0
 Innenzehner: 6
 weiteste: 1097 (4), 1002 (12), 982 (15)
 beste Teiler 50.9 (11.) 97.0 (3.) 123.0 (13.)
 Trefferlage 0.67 mm links, 0.55 mm tief
 Streuwert 3.72, horizontal: 4.99, vertikal: 1.68

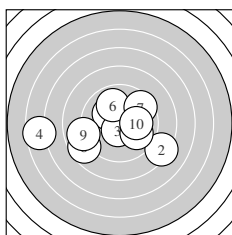
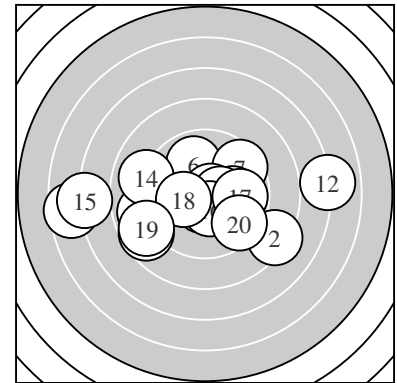

Serie 1:
 10.2 * 8.3 ↘ 10.6 * 6.6 ← 9.9 ↘
 9.9 ↗ 9.5 ↗ 8.7 ↙ 8.9 ← 10.0 →
 beste Teiler 97.0 (3.) 195.6 (1.) 226.0 (10.)
 Trefferlage 1.01 mm links, 0.59 mm tief
 Streuwert 3.71, horizontal: 4.82, vertikal: 2.06

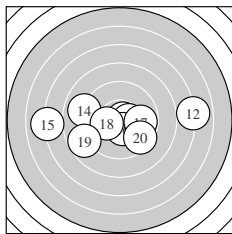

Serie 2:
 10.8 * 6.9 → 10.5 * 9.0 ← 7.0 ←
 10.4 * 9.8 → 10.2 * 8.7 ← 9.5 ↘
 beste Teiler 50.9 (11.) 123.0 (13.) 127.4 (16.)
 Trefferlage 0.34 mm links, 0.50 mm tief
 Streuwert 3.92, horizontal: 5.39, vertikal: 1.31

Unterschrift des Schützen