

Ergebnis: **180.6** (170)
 Serien: 92.1 88.5
 Zaehler: 4 9 3 3 0 0 1 0 0 0
 Innenzehner: 2
 weiteste: 1647 (19), 874 (16), 851 (6)
 beste Teiler 129.4 (12.) 192.6 (1.) 227.7 (7.)
 Trefferlage 0.94 mm links, 0.31 mm hoch
 Streuwert 4.23, horizontal: 5.16, vertikal: 3.04

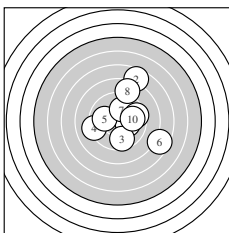

Serie 1:
 10.2 * 7.6 ↗ 9.6 ↓ 9.2 ← 10.0 ←
 7.5 ↘ 10.0 ↑ 8.6 ↑ 9.5 → 9.9 →
 beste Teiler 192.6 (1.) 227.7 (7.) 241.2 (5.)
 Trefferlage 1.57 mm rechts, 0.85 mm hoch
 Streuwert 3.41, horizontal: 3.27, vertikal: 3.56

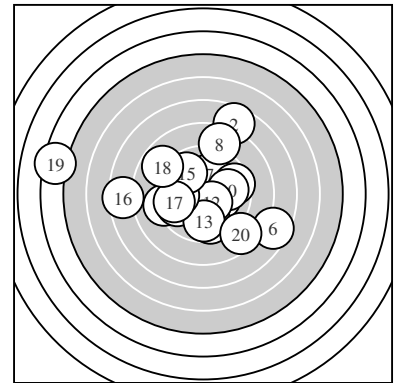
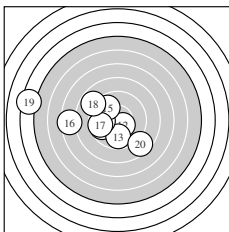

Serie 2:
 9.7 ← 10.4 * 9.8 ↓ 9.9 ← 9.8 ↖
 7.5 ← 9.6 ← 8.8 ↖ 4.4 ← 8.6 ↘
 beste Teiler 129.4 (12.) 267.4 (14.) 291.2 (15.)
 Trefferlage 3.45 mm links, 0.22 mm tief
 Streuwert 4.34, horizontal: 5.61, vertikal: 2.49

Unterschrift des Schuetzen

Ergebnis: **185.8** (174)
 Serien: 92.3 93.5
 Zaehler: 3 11 3 3 0 0 0 0 0 0
 Innenzehner: 3
 weiteste: 797 (11), 793 (19), 753 (1)
 beste Teiler 128.1 (12.) 169.0 (8.) 172.0 (16.)
 Trefferlage 0.35 mm rechts, 0.25 mm tief
 Streuwert 3.35, horizontal: 4.30, vertikal: 1.99

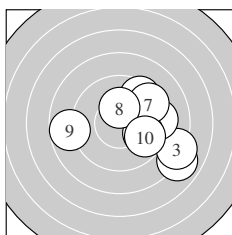
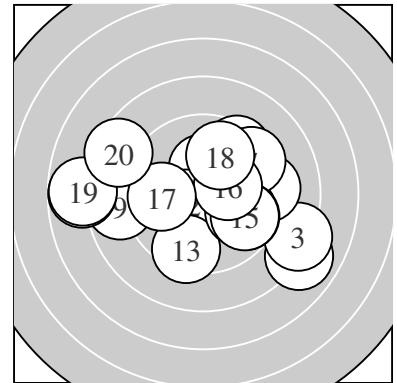

Serie 1:
 7.9 ↘ 9.5 → 8.2 ↘ 9.3 → 9.5 ↗
 9.8 ↘ 9.4 ↗ 10.3 * 8.7 ← 9.7 ↘
 beste Teiler 169.0 (8.) 280.0 (6.) 314.8 (10.)
 Trefferlage 2.56 mm rechts, 0.38 mm tief
 Streuwert 2.86, horizontal: 3.39, vertikal: 2.21

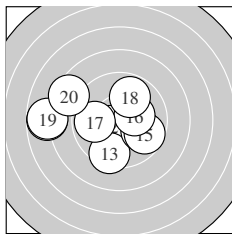

Serie 2:
 7.8 ← 10.4 * 9.4 ↓ 9.9 ↘ 9.7 ↘
 10.3 * 9.9 ← 9.8 ↑ 7.8 ← 8.5 ↘
 beste Teiler 128.1 (12.) 172.0 (16.) 266.9 (14.)
 Trefferlage 1.85 mm links, 0.11 mm tief
 Streuwert 3.18, horizontal: 4.09, vertikal: 1.86

Unterschrift des Schuetzen

Ergebnis: **200.6** (189)
 Serien: 99.2 101.4
 Zaehler: 11 8 0 1 0 0 0 0 0 0
 Innenzehner: 9
 weiteste: 835 (3), 327 (16), 300 (12)
 beste Teiler 78.2 (11.) 98.7 (19.) 107.6 (15.)
 Trefferlage 0.82 mm links, 0.37 mm hoch
 Streuwert 1.93, horizontal: 2.44, vertikal: 1.22

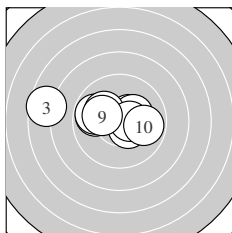
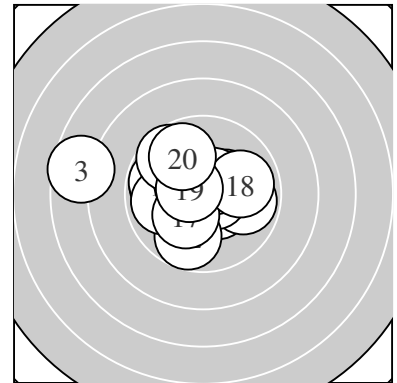

Serie 1:
 10.5 * 10.3 * 7.6 ← 10.5 * 9.9 ←
 9.8 ← 10.1 ↖ 10.5 * 10.1 ← 9.9 →
 beste Teiler 112.0 (8.) 124.6 (1.) 124.9 (4.)
 Trefferlage 1.00 mm links, 0.49 mm hoch
 Streuwert 2.31, horizontal: 3.19, vertikal: 0.73

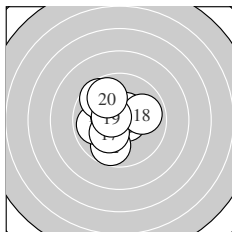

Serie 2:
 10.6 * 9.8 ↓ 9.9 ← 10.5 * 10.5 *
 9.6 ↘ 10.2 * 9.9 → 10.6 * 9.8 ↖
 beste Teiler 78.2 (11.) 98.7 (19.) 107.6 (15.)
 Trefferlage 0.63 mm links, 0.25 mm hoch
 Streuwert 1.57, horizontal: 1.53, vertikal: 1.61

Unterschrift des Schuetzen

Ergebnis: **193.6** (183)
 Serien: 97.7 95.9
 Zaehler: 8 8 3 1 0 0 0 0 0 0
 Innenzehner: 5
 weiteste: 894 (13), 651 (18), 569 (5)
 beste Teiler 62.9 (14.) 74.4 (9.) 78.1 (7.)
 Trefferlage 1.16 mm rechts, 0.39 mm hoch
 Streuwert 2.59, horizontal: 3.24, vertikal: 1.72

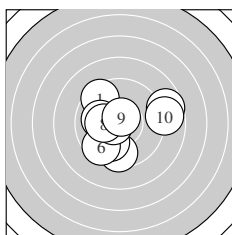
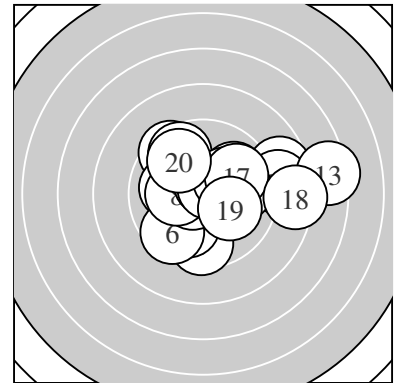

Serie 1:
 9.5 ↘ 10.0 ← 9.6 ↓ 10.0 ↙ 8.7 →
 9.6 ↗ 10.6 * 10.2 * 10.7 * 8.8 →
 beste Teiler 74.4 (9.) 78.1 (7.) 184.0 (8.)
 Trefferlage 0.03 mm rechts, 0.19 mm tief
 Streuwert 2.52, horizontal: 2.93, vertikal: 2.03

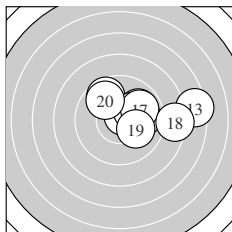

Serie 2:
 9.9 ↗ 9.9 → 7.4 → 10.7 * 9.7 ↖
 10.2 * 9.9 ↗ 8.3 → 10.1 ↘ 9.8 ↖
 beste Teiler 62.9 (14.) 183.6 (16.) 215.2 (19.)
 Trefferlage 2.30 mm rechts, 0.98 mm hoch
 Streuwert 2.45, horizontal: 3.27, vertikal: 1.16

Unterschrift des Schuetzen

Ergebnis: **188.2** (178)
 Serien: 96.2 92.0
 Zaehler: 6 8 4 2 0 0 0 0 0 0
 Innenzehner: 5
 weiteste: 852 (11), 763 (6), 744 (14)
 beste Teiler 45.5 (10.) 70.4 (16.) 77.9 (19.)
 Trefferlage 0.84 mm rechts, 1.57 mm hoch
 Streuwert 3.00, horizontal: 3.84, vertikal: 1.82

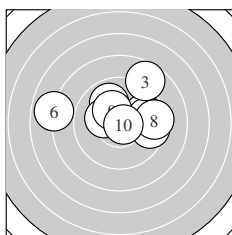
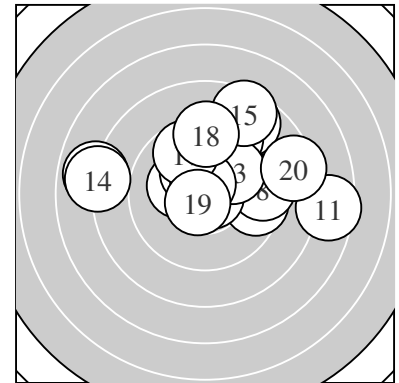

Serie 1:
 9.8 → 9.7 → 8.7 ↗ 9.9 ↖ 9.5 →
 7.9 ← 10.2 * 9.4 → 10.3 * 10.8 *
 beste Teiler 45.5 (10.) 171.1 (9.) 184.0 (7.)
 Trefferlage 0.53 mm rechts, 1.18 mm hoch
 Streuwert 2.72, horizontal: 3.54, vertikal: 1.53

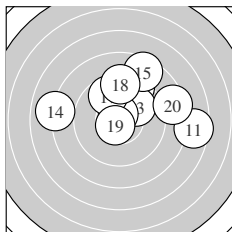

Serie 2:
 7.5 → 9.3 ↗ 10.0 ↗ 8.0 ← 8.5 ↗
 10.7 * 9.7 ↖ 9.3 ↑ 10.6 * 8.4 →
 beste Teiler 70.4 (16.) 77.9 (19.) 245.2 (13.)
 Trefferlage 1.15 mm rechts, 1.96 mm hoch
 Streuwert 3.37, horizontal: 4.29, vertikal: 2.08

Unterschrift des Schuetzen

Ergebnis: **196.0** (187)
 Serien: 98.6 97.4
 Zaehler: 10 7 3 0 0 0 0 0 0 0
 Innenzehner: 5
 weiteste: 515 (17), 510 (6), 503 (1)
 beste Teiler 24.0 (19.) 98.6 (7.) 114.0 (13.)
 Trefferlage 0.83 mm rechts, 0.14 mm tief
 Streuwert 2.27, horizontal: 2.87, vertikal: 1.43

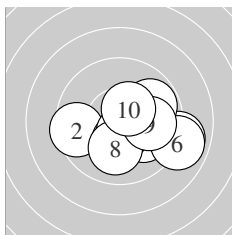
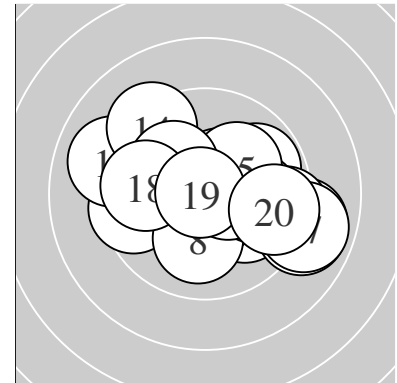

Serie 1:
 8.9 → 9.5 ← 9.8 ↗ 10.3 * 10.0 ↘
 8.9 → 10.6 * 10.1 ↓ 10.0 → 10.5 *
 beste Teiler 98.6 (7.) 125.4 (10.) 159.0 (4.)
 Trefferlage 1.36 mm rechts, 0.77 mm tief
 Streuwert 1.96, horizontal: 2.52, vertikal: 1.16

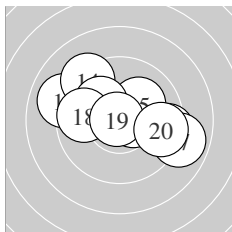

Serie 2:
 9.3 → 9.0 ← 10.5 * 9.3 ↖ 10.1 ↗
 10.1 ↖ 8.9 → 9.8 ← 10.9 * 9.5 →
 beste Teiler 24.0 (19.) 114.0 (13.) 205.1 (15.)
 Trefferlage 0.30 mm rechts, 0.47 mm hoch
 Streuwert 2.50, horizontal: 3.22, vertikal: 1.46

Unterschrift des Schuetzen

Ergebnis: **205.0** (196)
 Serien: 101.9 103.1
 Zaehler: 16 4 0 0 0 0 0 0 0 0
 Innenzehner: 14
 weiteste: 422 (17), 320 (20), 298 (4)
 beste Teiler 62.9 (13.) 64.8 (19.) 93.1 (11.)
 Trefferlage 0.02 mm rechts, 0.90 mm hoch
 Streuwert 1.29, horizontal: 1.40, vertikal: 1.16

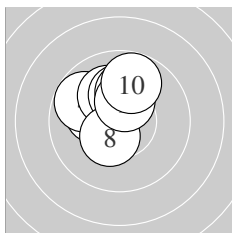
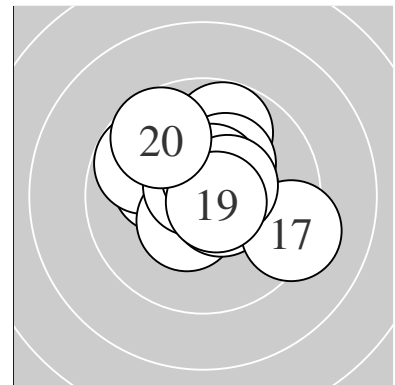

Serie 1:
 10.5 * 10.2 * 10.5 * 9.8 ↘ 10.1 ↖
 10.2 * 10.1 ↑ 10.4 * 10.3 * 9.8 ↑
 beste Teiler 104.4 (3.) 117.0 (1.) 132.3 (8.)
 Trefferlage 0.56 mm links, 1.30 mm hoch
 Streuwert 1.07, horizontal: 1.05, vertikal: 1.08

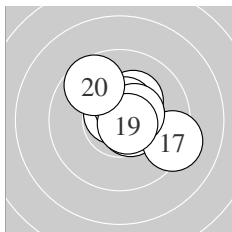

Serie 2:
 10.6 * 10.4 * 10.7 * 10.2 * 10.5 *
 10.5 * 9.3 ↘ 10.5 * 10.7 * 9.7 ↘
 beste Teiler 62.9 (13.) 64.8 (19.) 93.1 (11.)
 Trefferlage 0.61 mm rechts, 0.49 mm hoch
 Streuwert 1.34, horizontal: 1.50, vertikal: 1.16

Unterschrift des Schuetzen

Ergebnis: **196.8** (189)
 Serien: 99.3 97.5
 Zaehler: 12 6 1 1 0 0 0 0 0 0
 Innenzehner: 9
 weiteste: 804 (20), 520 (10), 468 (19)
 beste Teiler 56.7 (15.) 67.4 (7.) 79.0 (12.)
 Trefferlage 1.00 mm links, 0.84 mm hoch
 Streuwert 2.25, horizontal: 2.85, vertikal: 1.42

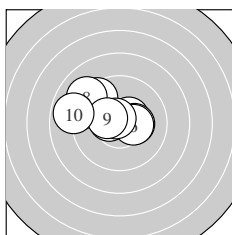
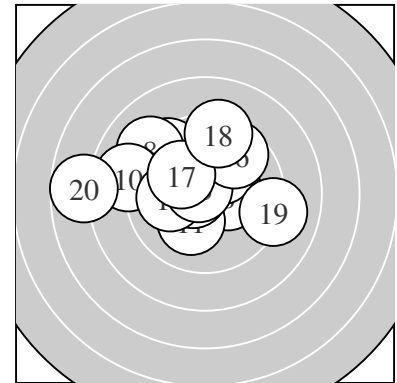

Serie 1:
 10.5 * 9.5 ↘ 10.3 * 10.5 * 9.1 ↖
 10.3 * 10.7 * 9.1 ↘ 10.4 * 8.9 ←
 beste Teiler 67.4 (7.) 117.6 (4.) 119.5 (1.)
 Trefferlage 1.44 mm links, 0.99 mm hoch
 Streuwert 1.88, horizontal: 2.43, vertikal: 1.09

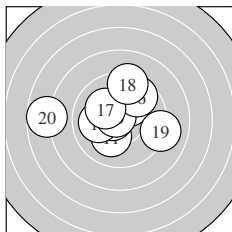

Serie 2:
 10.1 ↙ 10.6 * 10.2 * 10.0 ← 10.7 *
 9.7 ↗ 10.1 ↘ 9.3 ↑ 9.1 → 7.7 ←
 beste Teiler 56.7 (15.) 79.0 (12.) 189.7 (13.)
 Trefferlage 0.56 mm links, 0.69 mm hoch
 Streuwert 2.63, horizontal: 3.29, vertikal: 1.74

Unterschrift des Schuetzen

Ergebnis: **161.8** (152)
 Serien: 75.4 86.4
 Zaehler: 0 6 6 6 1 0 0 0 1 0
 Innenzehner: 0
 weiteste: 2102 (2), 1087 (11), 957 (9)
 beste Teiler 351.2 (1.) 388.8 (20.) 417.8 (14.)
 Trefferlage 2.16 mm rechts, 1.91 mm tief
 Streuwert 5.49, horizontal: 7.00, vertikal: 3.34

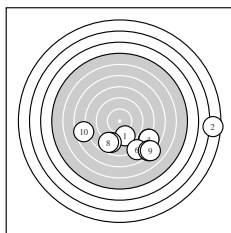
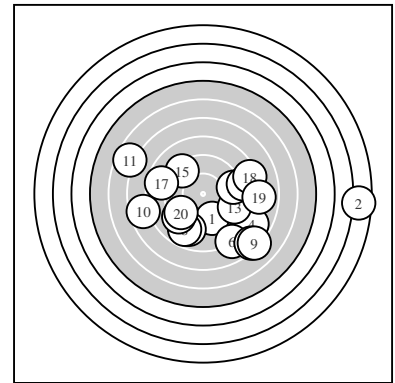

Serie 1:
 9.5 ↘ 2.5 → 7.9 ↘ 7.9 ↘ 8.9 ↙
 8.0 ↘ 7.2 ↘ 8.8 ↙ 7.1 ↘ 7.6 ←
 beste Teiler 351.2 (1.) 512.7 (5.) 538.0 (8.)
 Trefferlage 4.01 mm rechts, 4.42 mm tief
 Streuwert 5.66, horizontal: 7.79, vertikal: 1.82

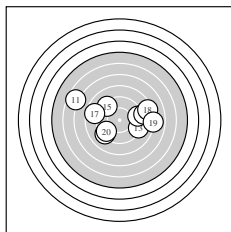

Serie 2:
 6.6 ↖ 9.2 ↙ 9.1 ↘ 9.3 → 9.3 ↖
 8.7 → 8.6 ← 8.3 → 7.9 → 9.4 ↙
 beste Teiler 388.8 (20.) 417.8 (14.) 419.8 (15.)
 Trefferlage 0.30 mm rechts, 0.59 mm hoch
 Streuwert 4.55, horizontal: 5.93, vertikal: 2.50

Unterschrift des Schuetzen

Ergebnis: **0.0** (0)_{DNS}

Serien:

Zaehler: 0 0 0 0 0 0 0 0 0 0

Innenzehner: 0

weiteste:

beste Teiler - Schütze ist nicht zum Wettkampf angetreten

Trefferlage 0.00 mm , 0.00 mm

Streuwert

Unterschrift des Schuetzen

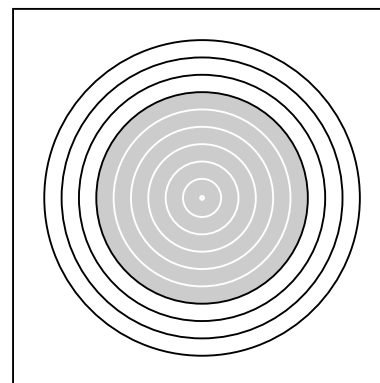

Ergebnis: **189.4** (181)
 Serien: 95.3 94.1
 Zaehler: 7 8 4 1 0 0 0 0 0 0
 Innenzehner: 4
 weiteste: 904 (11), 667 (3), 656 (19)
 beste Teiler 56.5 (9.) 140.9 (18.) 151.4 (17.)
 Trefferlage 0.16 mm links, 0.28 mm tief
 Streuwert 3.05, horizontal: 3.19, vertikal: 2.90

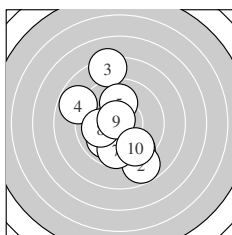
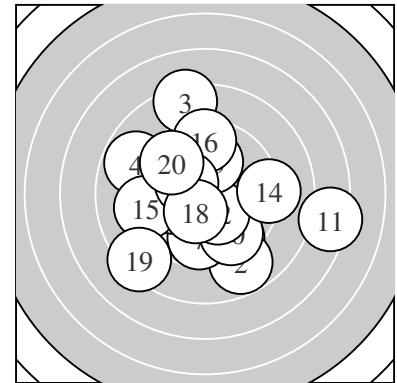

Serie 1:
 9.5 ↘ 8.8 ↘ 8.3 ↑ 8.8 ↖ 10.0 ↑
 9.9 ↙ 9.7 ↓ 10.0 ← 10.7 * 9.6 ↘
 beste Teiler 56.5 (9.) 231.1 (8.) 238.3 (5.)
 Trefferlage 0.48 mm links, 0.48 mm tief
 Streuwert 2.89, horizontal: 2.24, vertikal: 3.42

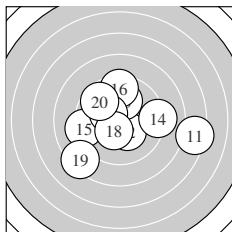

Serie 2:
 7.3 → 10.3 * 10.0 ↑ 9.1 → 9.2 ←
 9.5 ↑ 10.3 * 10.4 * 8.3 ↙ 9.7 ↖
 beste Teiler 140.9 (18.) 151.4 (17.) 161.1 (12.)
 Trefferlage 0.14 mm rechts, 0.08 mm tief
 Streuwert 3.33, horizontal: 4.04, vertikal: 2.44

Unterschrift des Schuetzen

Ergebnis: **202.5** (195)
 Serien: 101.4 101.1
 Zaehler: 15 5 0 0 0 0 0 0 0 0
 Innenzehner: 11
 weiteste: 498 (12), 403 (2), 396 (4)
 beste Teiler 20.8 (11.) 50.9 (16.) 59.0 (7.)
 Trefferlage 0.40 mm rechts, 0.05 mm tief
 Streuwert 1.74, horizontal: 2.20, vertikal: 1.10

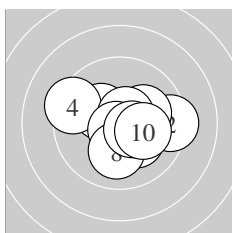
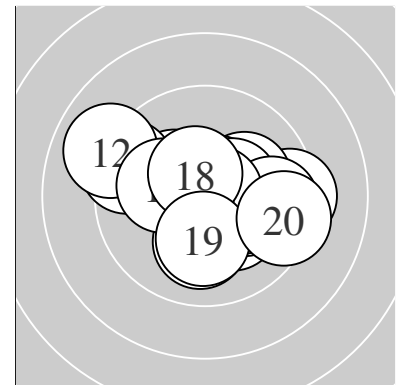

Serie 1:
 10.3 * 9.3 → 10.1 ↗ 9.4 ↖ 10.6 *
 10.2 * 10.7 * 10.1 ↓ 10.5 * 10.2 *
 beste Teiler 59.0 (7.) 80.8 (5.) 109.5 (9.)
 Trefferlage 0.48 mm rechts, 0.13 mm tief
 Streuwert 1.68, horizontal: 2.10, vertikal: 1.11

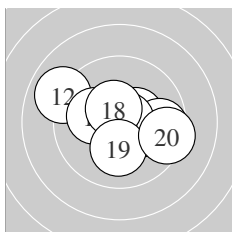

Serie 2:
 10.9 * 9.0 ↖ 10.2 * 10.4 * 9.7 →
 10.8 * 10.1 ↖ 10.5 * 10.1 ↓ 9.4 →
 beste Teiler 20.8 (11.) 50.9 (16.) 116.8 (18.)
 Trefferlage 0.32 mm rechts, 0.02 mm hoch
 Streuwert 1.89, horizontal: 2.41, vertikal: 1.15

Unterschrift des Schuetzen

Ergebnis: **140.7** (132)
 Serien: 66.6 74.1
 Zaehler: 2 2 3 6 1 3 1 1 0 0
 Innenzehner: 1
 weiteste: 5044 (5), 1882 (11), 1515 (10)
 beste Teiler 120.5 (18.) 210.2 (14.) 292.9 (9.)
 Trefferlage 1.44 mm links, 3.94 mm hoch
 Streuwert 10.41, horizontal: 10.71, vertikal: 10.11

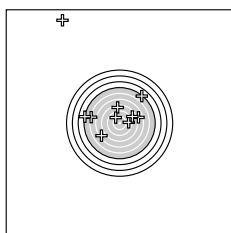
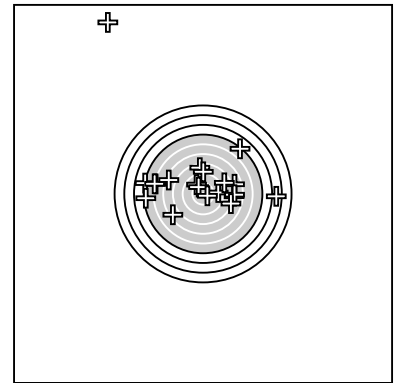

Serie 1:
 9.4 → 8.2 ↑ 5.0 ↗ 7.6 → 0.0 ↘
 6.0 ← 7.2 ↙ 8.5 ↘ 9.8 ↘ 4.9 ←
 beste Teiler 292.9 (9.) 390.7 (1.) 616.3 (8.)
 Trefferlage 3.49 mm links, 7.06 mm hoch
 Streuwert 12.48, horizontal: 11.12, vertikal: 13.70

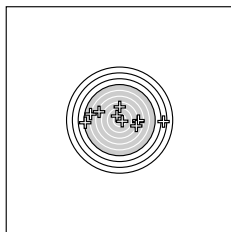

Serie 2:
 3.4 → 5.0 ← 7.8 → 10.1 ↘ 7.7 →
 7.9 → 5.9 ← 10.5 * 8.7 ↑ 7.1 ←
 beste Teiler 120.5 (18.) 210.2 (14.) 569.0 (19.)
 Trefferlage 0.60 mm rechts, 0.82 mm hoch
 Streuwert 7.60, horizontal: 10.45, vertikal: 2.51

Unterschrift des Schuetzen

Ergebnis: **183.7** (173)
 Serien: 94.1 89.6
 Zaehler: 3 9 7 0 1 0 0 0 0 0
 Innenzehner: 1
 weiteste: 1132 (16), 651 (20), 597 (15)
 beste Teiler 176.7 (9.) 231.4 (19.) 240.5 (7.)
 Trefferlage 1.05 mm links, 0.48 mm hoch
 Streuwert 3.43, horizontal: 4.28, vertikal: 2.29

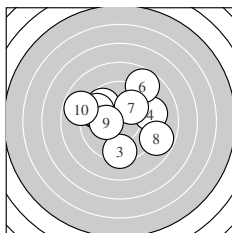
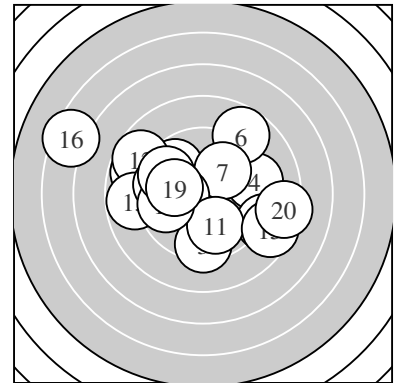

Serie 1:
 9.6 ↖ 9.7 ↖ 9.4 ↓ 9.3 → 9.6 ↖
 8.7 ↗ 10.0 ↗ 8.8 ↘ 10.2 * 8.8 ↖
 beste Teiler 176.7 (9.) 240.5 (7.) 304.1 (2.)
 Trefferlage 0.17 mm links, 0.76 mm hoch
 Streuwert 2.94, horizontal: 3.40, vertikal: 2.40

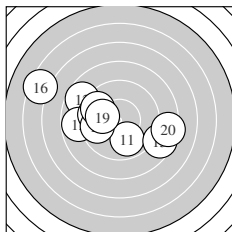

Serie 2:
 9.9 ↓ 8.7 ↖ 8.8 ← 9.6 ← 8.6 →
 6.4 ↖ 9.7 ← 9.6 ↖ 10.0 ← 8.3 →
 beste Teiler 231.4 (19.) 266.6 (11.) 304.4 (17.)
 Trefferlage 1.94 mm links, 0.21 mm hoch
 Streuwert 3.90, horizontal: 5.03, vertikal: 2.26

Unterschrift des Schuetzen

Ergebnis: **174.1** (166)
 Serien: 88.3 85.8
 Zaehler: 5 5 3 5 2 0 0 0 0 0
 Innenzehner: 4
 weiteste: 1150 (4), 1072 (19), 965 (16)
 beste Teiler 60.1 (13.) 78.7 (12.) 110.6 (1.)
 Trefferlage 0.24 mm links, 1.00 mm hoch
 Streuwert 4.72, horizontal: 6.22, vertikal: 2.43

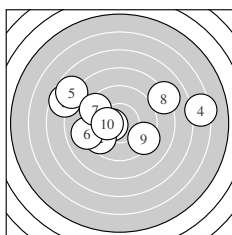
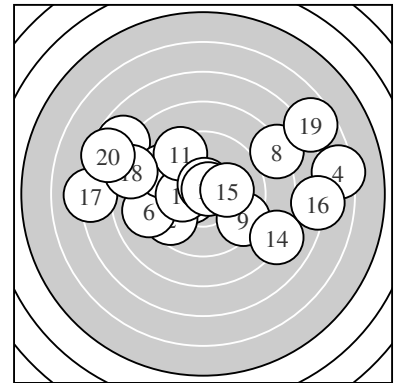

Serie 1:
 10.5 * 9.6 ↙ 7.7 ↖ 6.4 → 7.8 ↘
 9.1 ← 9.4 ↘ 8.1 ↗ 9.4 ↘ 10.3 *
 beste Teiler 110.6 (1.) 173.1 (10.) 339.4 (2.)
 Trefferlage 0.68 mm links, 0.88 mm hoch
 Streuwert 4.55, horizontal: 5.97, vertikal: 2.37

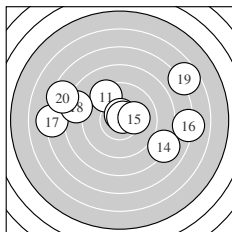

Serie 2:
 9.4 ↘ 10.6 * 10.7 * 8.1 ↘ 10.1 →
 7.1 → 7.2 ← 8.4 ← 6.7 ↗ 7.5 ↖
 beste Teiler 60.1 (13.) 78.7 (12.) 203.6 (15.)
 Trefferlage 0.20 mm rechts, 1.12 mm hoch
 Streuwert 5.11, horizontal: 6.75, vertikal: 2.60

Unterschrift des Schuetzen

Ergebnis: **192.1** (185)
 Serien: 95.8 96.3
 Zaehler: 7 11 2 0 0 0 0 0 0 0
 Innenzehner: 6
 weiteste: 720 (17), 628 (1), 474 (11)
 beste Teiler 91.4 (13.) 92.5 (5.) 118.3 (14.)
 Trefferlage 1.31 mm rechts, 0.96 mm hoch
 Streuwert 2.49, horizontal: 3.27, vertikal: 1.32

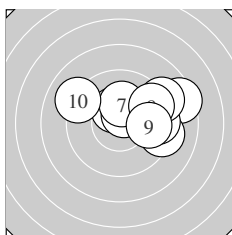
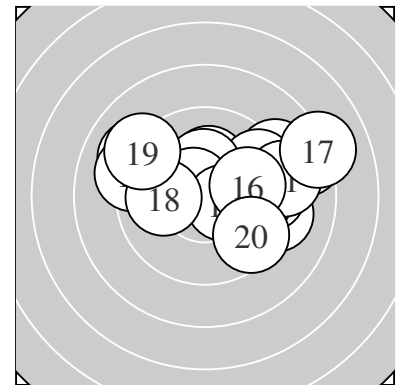

Serie 1:
 8.4 → 10.4 * 9.2 → 9.5 → 10.6 *
 9.1 → 10.2 * 9.5 → 9.8 → 9.1 ↖
 beste Teiler 92.5 (5.) 141.5 (2.) 190.2 (7.)
 Trefferlage 1.99 mm rechts, 1.13 mm hoch
 Streuwert 2.25, horizontal: 2.96, vertikal: 1.17

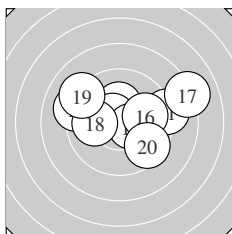

Serie 2:
 9.1 → 10.3 * 10.6 * 10.5 * 9.2 ↖
 9.9 → 8.1 → 10.0 ← 9.1 ↖ 9.5 ↘
 beste Teiler 91.4 (13.) 118.3 (14.) 171.2 (12.)
 Trefferlage 0.64 mm rechts, 0.78 mm hoch
 Streuwert 2.74, horizontal: 3.58, vertikal: 1.50

Unterschrift des Schuetzen

Ergebnis: **202.8** (193)
 Serien: 102.0 100.8
 Zaehler: 14 5 1 0 0 0 0 0 0 0
 Innenzehner: 11
 weiteste: 523 (17), 376 (4), 372 (13)
 beste Teiler 38.2 (2.) 42.5 (14.) 62.0 (15.)
 Trefferlage 0.46 mm links, 0.05 mm hoch
 Streuwert 1.71, horizontal: 2.08, vertikal: 1.22

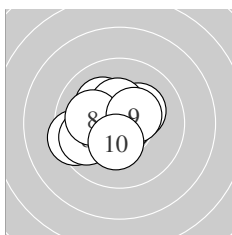
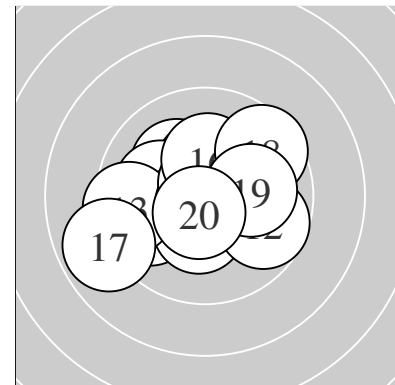

Serie 1:
 10.1 ↘ 10.8 * 10.5 * 9.4 ← 10.2 *
 9.8 ← 10.4 * 10.1 ← 10.4 * 10.3 *
 beste Teiler 38.2 (2.) 110.9 (3.) 132.4 (9.)
 Trefferlage 0.77 mm links, 0.20 mm hoch
 Streuwert 1.41, horizontal: 1.65, vertikal: 1.11

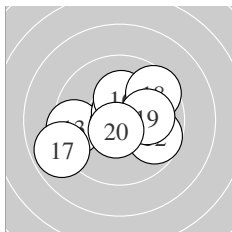

Serie 2:
 10.7 * 9.7 → 9.5 ← 10.8 * 10.7 *
 10.2 * 8.9 ← 9.6 ↗ 10.1 → 10.6 *
 beste Teiler 42.5 (14.) 62.0 (15.) 70.3 (11.)
 Trefferlage 0.15 mm links, 0.10 mm tief
 Streuwert 2.01, horizontal: 2.49, vertikal: 1.36

Unterschrift des Schuetzen

Ergebnis: **190.2** (180)
 Serien: 94.4 95.8
 Zaehler: 4 12 4 0 0 0 0 0 0 0
 Innenzehner: 2
 weiteste: 622 (8), 580 (16), 528 (4)
 beste Teiler 130.9 (11.) 153.3 (12.) 211.1 (5.)
 Trefferlage 2.72 mm rechts, 0.93 mm hoch
 Streuwert 1.84, horizontal: 2.21, vertikal: 1.37

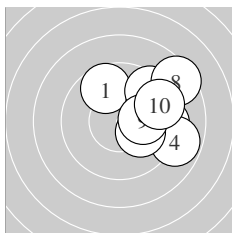
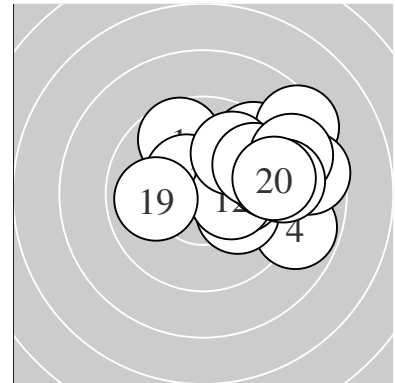

Serie 1:
 9.7 ↖ 9.4 → 9.3 → 8.8 ↘ 10.1 ↘
 9.7 ↗ 9.4 ↗ 8.5 ↗ 10.1 → 9.4 →
 beste Teiler 211.1 (5.) 211.6 (9.) 304.1 (6.)
 Trefferlage 2.98 mm rechts, 0.87 mm hoch
 Streuwert 1.83, horizontal: 1.85, vertikal: 1.82

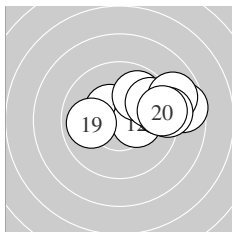

Serie 2:
 10.4 * 10.3 * 9.5 → 9.9 ↗ 9.7 ↗
 8.6 → 8.9 → 9.2 → 9.9 ← 9.4 →
 beste Teiler 130.9 (11.) 153.3 (12.) 255.4 (19.)
 Trefferlage 2.46 mm rechts, 0.99 mm hoch
 Streuwert 1.92, horizontal: 2.59, vertikal: 0.82

Unterschrift des Schuetzen

Ergebnis: **188.7** (181)
 Serien: 91.7 97.0
 Zaehler: 6 11 2 0 1 0 0 0 0 0
 Innenzehner: 6
 weiteste: 1233 (5), 669 (13), 567 (7)
 beste Teiler 63.1 (16.) 139.1 (11.) 152.7 (6.)
 Trefferlage 2.22 mm links, 0.52 mm tief
 Streuwert 2.84, horizontal: 3.68, vertikal: 1.60

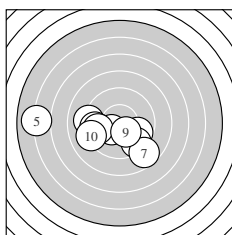
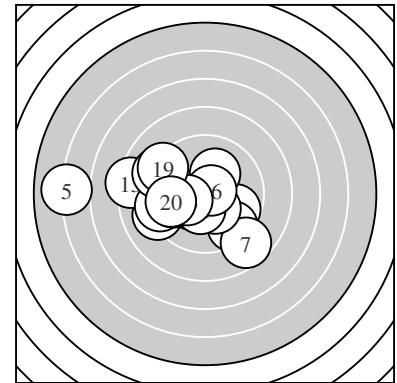

Serie 1:
 9.7 ↘ 9.1 ← 9.4 ↘ 9.5 ← 6.0 ←
 10.3 * 8.7 ↘ 9.6 ← 10.3 * 9.1 ←
 beste Teiler 152.7 (6.) 159.8 (9.) 301.8 (1.)
 Trefferlage 1.94 mm links, 1.33 mm tief
 Streuwert 3.53, horizontal: 4.78, vertikal: 1.44

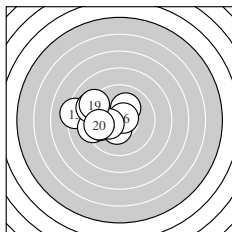

Serie 2:
 10.4 * 10.2 * 8.3 ← 9.3 ← 9.1 ↘
 10.7 * 9.8 ← 10.3 * 9.2 ↘ 9.7 ←
 beste Teiler 63.1 (16.) 139.1 (11.) 167.2 (18.)
 Trefferlage 2.50 mm links, 0.28 mm hoch
 Streuwert 1.93, horizontal: 2.36, vertikal: 1.36

Unterschrift des Schuetzen

Ergebnis: **197.1** (187)
 Serien: 98.1 99.0
 Zaehler: 8 11 1 0 0 0 0 0 0 0
 Innenzehner: 6
 weiteste: 590 (14), 498 (8), 412 (19)
 beste Teiler 50.0 (6.) 54.4 (16.) 128.5 (20.)
 Trefferlage 0.21 mm rechts, 1.00 mm tief
 Streuwert 2.07, horizontal: 2.75, vertikal: 1.02

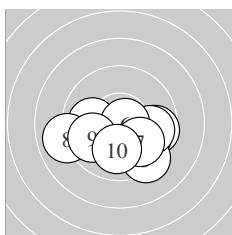
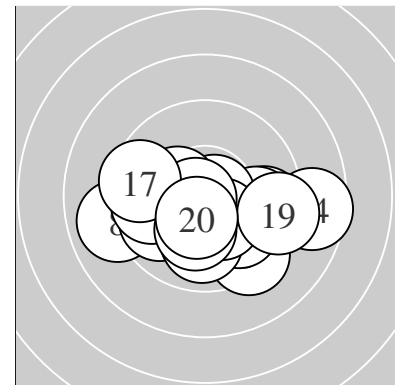

Serie 1:
 9.6 → 9.8 ↘ 9.4 ↘ 10.0 ← 9.8 →
 10.8 * 9.9 ↘ 9.0 ← 9.8 ← 10.0 ↓
 beste Teiler 50.0 (6.) 237.3 (10.) 248.0 (4.)
 Trefferlage 0.32 mm rechts, 1.23 mm tief
 Streuwert 2.07, horizontal: 2.75, vertikal: 1.02

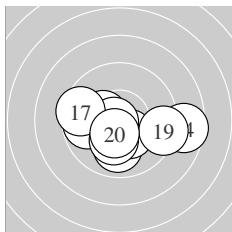

Serie 2:
 10.3 * 9.9 ↓ 10.3 * 8.6 → 9.8 ←
 10.7 * 9.5 ← 10.2 * 9.3 → 10.4 *
 beste Teiler 54.4 (16.) 128.5 (20.) 154.5 (13.)
 Trefferlage 0.10 mm rechts, 0.77 mm tief
 Streuwert 2.17, horizontal: 2.90, vertikal: 1.01

Unterschrift des Schuetzen

Ergebnis: **186.9** (179)
 Serien: 96.4 90.5
 Zaehler: 5 11 3 0 1 0 0 0 0 0
 Innenzehner: 2
 weiteste: 1067 (16), 713 (18), 693 (10)
 beste Teiler 177.7 (3.) 192.3 (20.) 222.1 (15.)
 Trefferlage 0.25 mm links, 0.50 mm hoch
 Streuwert 3.28, horizontal: 3.92, vertikal: 2.47

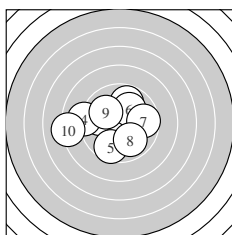
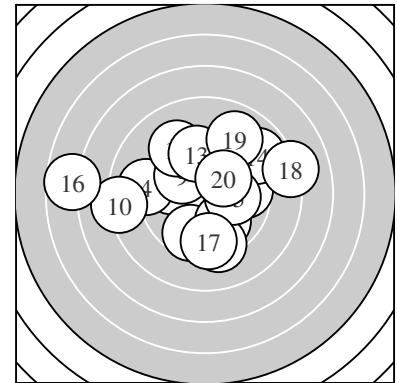

Serie 1:
 9.8 ↗ 9.9 ← 10.2 * 9.0 ← 9.6 ↓
 10.1 ↖ 9.7 → 9.9 ↘ 10.0 ↖ 8.2 ←
 beste Teiler 177.7 (3.) 224.9 (6.) 234.7 (9.)
 Trefferlage 0.99 mm links, 0.03 mm tief
 Streuwert 2.57, horizontal: 3.10, vertikal: 1.89

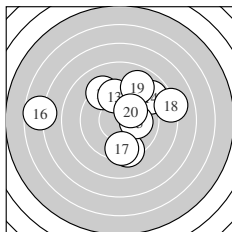

Serie 2:
 9.2 ↖ 9.3 ↓ 9.6 ↑ 8.9 ↗ 10.1 →
 6.7 ← 9.4 ↓ 8.1 → 9.0 ↗ 10.2 *
 beste Teiler 192.3 (20.) 222.1 (15.) 329.1 (13.)
 Trefferlage 0.48 mm rechts, 1.04 mm hoch
 Streuwert 3.89, horizontal: 4.65, vertikal: 2.94

Unterschrift des Schuetzen

Ergebnis: **188.9** (179)
 Serien: 98.7 90.2
 Zaehler: 7 7 4 2 0 0 0 0 0 0
 Innenzehner: 5
 weiteste: 973 (11), 792 (19), 647 (17)
 beste Teiler 66.2 (6.) 92.0 (20.) 109.1 (7.)
 Trefferlage 2.14 mm rechts, 0.68 mm hoch
 Streuwert 2.84, horizontal: 3.54, vertikal: 1.89

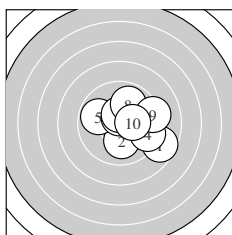
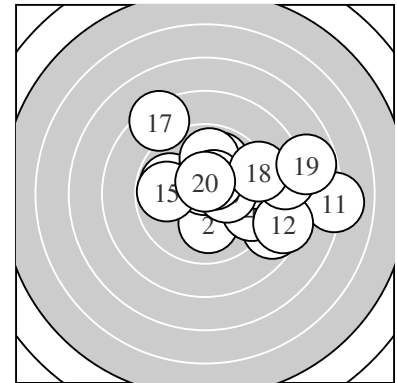

Serie 1:
 8.7 ↘ 10.1 ↓ 10.0 ↗ 9.5 ↘ 9.8 ↖
 10.7 * 10.5 * 9.9 ↑ 9.2 → 10.3 *
 beste Teiler 66.2 (6.) 109.1 (7.) 164.2 (10.)
 Trefferlage 1.50 mm rechts, 0.11 mm hoch
 Streuwert 2.00, horizontal: 2.31, vertikal: 1.63

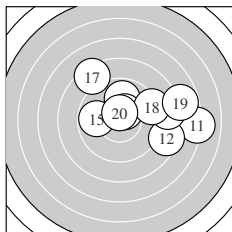

Serie 2:
 7.1 → 8.4 ↘ 9.9 ↑ 8.5 → 9.8 ↖
 10.5 * 8.4 ↖ 9.2 → 7.8 → 10.6 *
 beste Teiler 92.0 (20.) 122.9 (16.) 271.0 (13.)
 Trefferlage 2.79 mm rechts, 1.24 mm hoch
 Streuwert 3.50, horizontal: 4.50, vertikal: 2.05

Unterschrift des Schuetzen

Ergebnis: **185.2** (174)
 Serien: 90.8 94.4
 Zaehler: 5 9 4 1 0 0 1 0 0 0
 Innenzehner: 4
 weiteste: 1584 (1), 849 (11), 634 (8)
 beste Teiler 22.3 (15.) 68.5 (9.) 139.3 (12.)
 Trefferlage 1.23 mm links, 0.97 mm hoch
 Streuwert 3.73, horizontal: 4.58, vertikal: 2.62

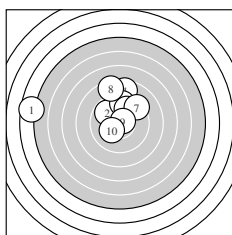
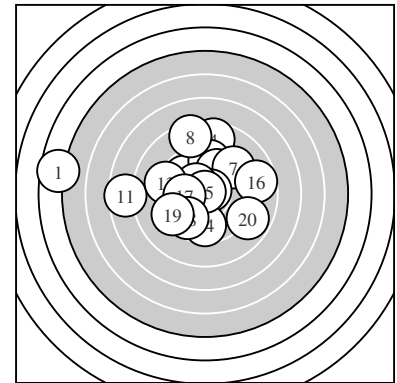

Serie 1:
 4.6 ← 9.8 ↘ 9.9 ↗ 8.6 ↑ 9.5 ↑
 9.8 ↗ 9.3 ↗ 8.4 ↑ 10.7 * 10.2 *
 beste Teiler 68.5 (9.) 186.9 (10.) 272.6 (3.)
 Trefferlage 1.34 mm links, 2.67 mm hoch
 Streuwert 4.04, horizontal: 5.27, vertikal: 2.21

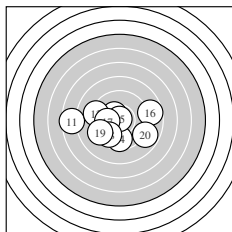

Serie 2:
 7.6 ← 10.4 * 9.2 ↘ 9.6 ↓ 10.9 *
 8.7 → 10.1 ← 9.7 ↙ 9.3 ↙ 8.9 ↘
 beste Teiler 22.3 (15.) 139.3 (12.) 220.5 (17.)
 Trefferlage 1.12 mm links, 0.72 mm tief
 Streuwert 3.13, horizontal: 4.06, vertikal: 1.77

Unterschrift des Schuetzen

Ergebnis: **196.8** (187)
 Serien: 98.4 98.4
 Zaehler: 8 11 1 0 0 0 0 0 0 0
 Innenzehner: 5
 weiteste: 547 (3), 440 (5), 420 (12)
 beste Teiler 113.0 (1.) 125.0 (19.) 125.1 (6.)
 Trefferlage 0.57 mm rechts, 0.06 mm tief
 Streuwert 2.14, horizontal: 2.62, vertikal: 1.51

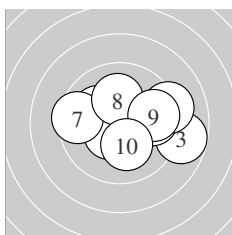
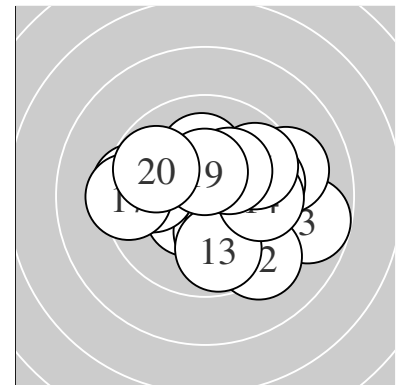

Serie 1:
 10.5 * 10.1 ↖ 8.8 → 9.8 → 9.2 →
 10.5 * 9.5 ← 10.1 ↑ 9.7 → 10.2 *
 beste Teiler 113.0 (1.) 125.1 (6.) 195.7 (10.)
 Trefferlage 0.93 mm rechts, 0.07 mm hoch
 Streuwert 2.20, horizontal: 2.83, vertikal: 1.29

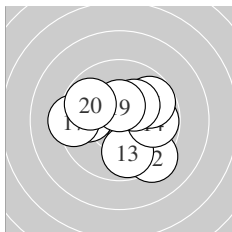

Serie 2:
 10.1 ↘ 9.3 ↘ 9.8 ↓ 9.8 → 9.8 ←
 9.7 ↗ 9.4 ← 10.2 * 10.5 * 9.8 ↖
 beste Teiler 125.0 (19.) 180.3 (18.) 221.0 (11.)
 Trefferlage 0.20 mm rechts, 0.20 mm tief
 Streuwert 2.16, horizontal: 2.48, vertikal: 1.77

Unterschrift des Schuetzen

Ergebnis: **205.3** (194)
 Serien: 103.6 101.7
 Zaehler: 14 6 0 0 0 0 0 0 0 0
 Innenzehner: 12
 weiteste: 342 (16), 322 (11), 315 (12)
 beste Teiler 31.7 (18.) 43.6 (2.) 48.7 (9.)
 Trefferlage 0.58 mm links, 0.09 mm tief
 Streuwert 1.38, horizontal: 1.70, vertikal: 0.97

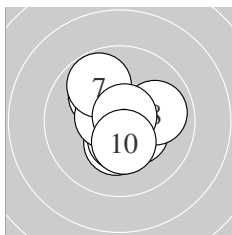
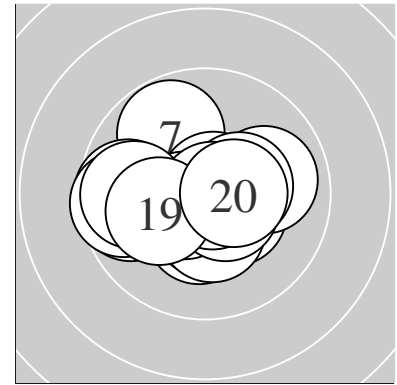

Serie 1:
 10.1 ↘ 10.8 * 10.3 * 10.5 * 10.6 *
 10.4 * 9.8 ↘ 9.9 → 10.8 * 10.4 *
 beste Teiler 43.6 (2.) 48.7 (9.) 93.9 (5.)
 Trefferlage 0.00 mm , 0.04 mm hoch
 Streuwert 1.27, horizontal: 1.18, vertikal: 1.35

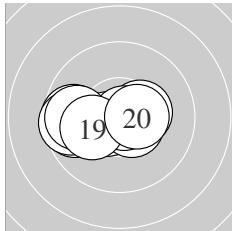

Serie 2:
 9.7 ← 9.7 ← 10.4 * 10.6 * 10.5 *
 9.6 ← 9.8 ← 10.8 * 10.1 ← 10.5 *
 beste Teiler 31.7 (18.) 98.4 (14.) 101.7 (15.)
 Trefferlage 1.16 mm links, 0.24 mm tief
 Streuwert 1.42, horizontal: 1.98, vertikal: 0.34

Unterschrift des Schuetzen

Ergebnis: **176.7** (168)
 Serien: 90.6 86.1
 Zaehler: 5 7 4 2 0 1 1 0 0 0
 Innenzehner: 5
 weiteste: 1528 (13), 1359 (18), 978 (5)
 beste Teiler 103.9 (4.) 110.3 (8.) 116.1 (7.)
 Trefferlage 0.96 mm links, 1.19 mm tief
 Streuwert 4.61, horizontal: 6.30, vertikal: 1.70

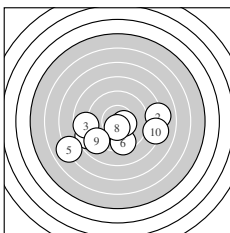
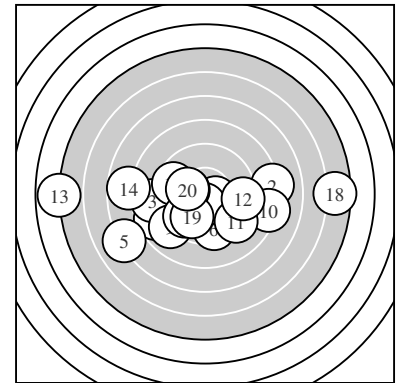

Serie 1:
 8.6 ← 8.1 → 8.7 ← 10.5 * 7.0 ←
 9.5 ↓ 10.5 * 10.5 * 9.0 ↙ 8.2 →
 beste Teiler 103.9 (4.) 110.3 (8.) 116.1 (7.)
 Trefferlage 0.64 mm links, 1.82 mm tief
 Streuwert 3.82, horizontal: 5.11, vertikal: 1.78

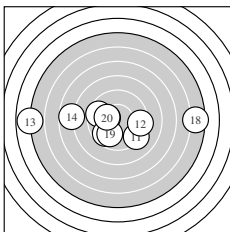

Serie 2:
 9.2 ↘ 9.3 → 4.8 ← 7.7 ← 9.6 ←
 10.2 * 9.7 ↙ 5.5 → 9.9 ↙ 10.2 *
 beste Teiler 180.7 (16.) 191.9 (20.) 275.4 (19.)
 Trefferlage 1.29 mm links, 0.55 mm tief
 Streuwert 5.45, horizontal: 7.57, vertikal: 1.43

Unterschrift des Schuetzen

Ergebnis: **206.5** (197)
 Serien: 103.1 103.4
 Zaehler: 17 3 0 0 0 0 0 0 0 0
 Innenzehner: 15
 weiteste: 389 (3), 305 (12), 265 (4)
 beste Teiler 6.4 (9.) 31.0 (20.) 71.1 (2.)
 Trefferlage 0.03 mm rechts, 0.44 mm hoch
 Streuwert 1.29, horizontal: 1.56, vertikal: 0.96

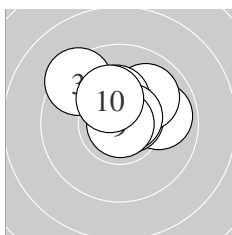
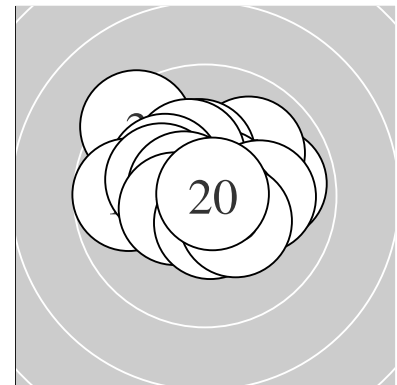

Serie 1:
 10.2 * 10.7 * 9.4 ↖ 9.9 → 10.7 *
 10.0 ↗ 10.3 * 10.7 * 10.9 * 10.3 *
 beste Teiler 6.4 (9.) 71.1 (2.) 73.4 (8.)
 Trefferlage 0.45 mm rechts, 0.98 mm hoch
 Streuwert 1.24, horizontal: 1.50, vertikal: 0.89

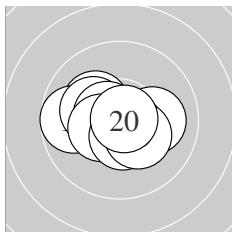

Serie 2:
 10.2 * 9.7 ← 10.1 → 10.2 * 10.6 *
 10.6 * 10.4 * 10.5 * 10.3 * 10.8 *
 beste Teiler 31.0 (20.) 90.2 (16.) 93.0 (15.)
 Trefferlage 0.37 mm links, 0.10 mm tief
 Streuwert 1.22, horizontal: 1.58, vertikal: 0.68

Unterschrift des Schuetzen

Ergebnis: **179.9** (172)
 Serien: 95.0 84.9
 Zaehler: 3 10 4 2 1 0 0 0 0 0
 Innenzehner: 2
 weiteste: 1126 (14), 945 (11), 859 (4)
 beste Teiler 94.2 (8.) 193.7 (2.) 242.0 (10.)
 Trefferlage 0.22 mm links, 1.29 mm hoch
 Streuwert 3.90, horizontal: 4.86, vertikal: 2.60

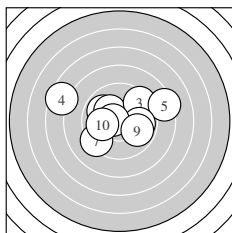
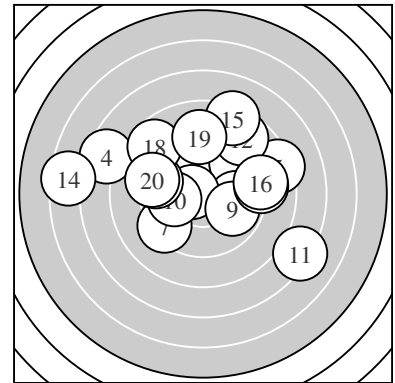

Serie 1:
 9.9 ↘ 10.2 * 9.4 ↗ 7.5 ↖ 8.3 →
 9.9 → 9.3 ↙ 10.6 * 9.9 ↘ 10.0 ←
 beste Teiler 94.2 (8.) 193.7 (2.) 242.0 (10.)
 Trefferlage 0.40 mm links, 0.62 mm hoch
 Streuwert 3.12, horizontal: 4.02, vertikal: 1.83

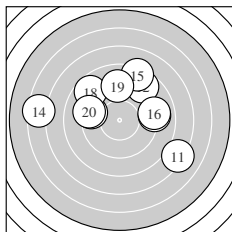

Serie 2:
 7.2 ↘ 8.7 ↗ 9.0 → 6.4 ← 8.3 ↗
 9.0 → 9.3 ← 8.7 ↘ 9.1 ↑ 9.2 ←
 beste Teiler 405.8 (17.) 437.9 (20.) 473.0 (19.)
 Trefferlage 0.04 mm links, 1.97 mm hoch
 Streuwert 4.66, horizontal: 5.79, vertikal: 3.16

Unterschrift des Schuetzen

Ergebnis: **171.9** (162)
 Serien: 87.5 84.4
 Zaehler: 3 5 6 3 3 0 0 0 0 0
 Innenzehner: 1
 weiteste: 1103 (12), 1072 (1), 1064 (2)
 beste Teiler 154.0 (3.) 224.7 (7.) 248.7 (19.)
 Trefferlage 3.80 mm links, 1.50 mm tief
 Streuwert 3.78, horizontal: 4.22, vertikal: 3.28

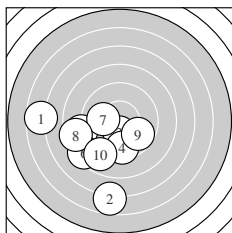
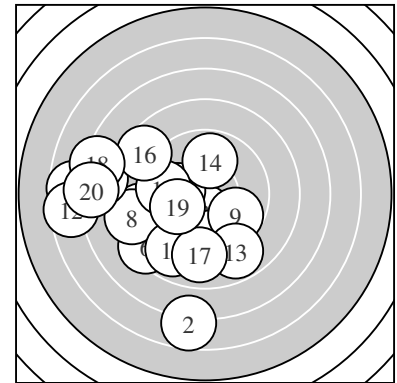

Serie 1:
 6.7 ← 6.7 ↓ 10.3 * 9.5 ↓ 8.8 ←
 8.4 ↙ 10.1 ← 8.4 ← 9.7 ↘ 8.9 ↙
 beste Teiler 154.0 (3.) 224.7 (7.) 304.0 (9.)
 Trefferlage 3.01 mm links, 2.87 mm tief
 Streuwert 3.51, horizontal: 3.81, vertikal: 3.19

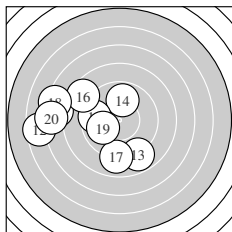

Serie 2:
 7.5 ← 6.5 ← 8.8 ↘ 9.9 ↑ 9.6 ←
 8.6 ↖ 9.0 ↓ 7.3 ← 10.0 ← 7.2 ←
 beste Teiler 248.7 (19.) 273.9 (14.) 344.5 (15.)
 Trefferlage 4.58 mm links, 0.13 mm tief
 Streuwert 3.88, horizontal: 4.67, vertikal: 2.90

Unterschrift des Schuetzen

Ergebnis: **177.1** (169)
 Serien: 88.7 88.4
 Zaehler: 2 8 7 3 0 0 0 0 0 0
 Innenzehner: 0
 weiteste: 999 (8), 846 (20), 779 (1)
 beste Teiler 218.0 (19.) 226.2 (12.) 297.8 (10.)
 Trefferlage 0.01 mm rechts, 0.68 mm hoch
 Streuwert 4.08, horizontal: 4.67, vertikal: 3.38

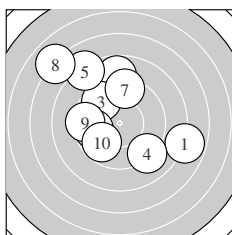
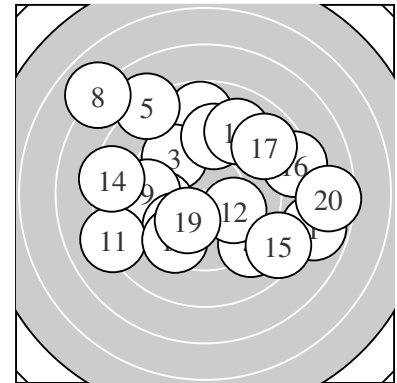

Serie 1:
 7.8 ↘ 8.8 ↑ 9.6 ↙ 9.1 ↘ 8.1 ↙
 9.7 ← 9.4 ↑ 7.0 ↘ 9.4 ← 9.8 ↙
 beste Teiler 297.8 (10.) 304.9 (6.) 326.6 (3.)
 Trefferlage 1.15 mm links, 1.61 mm hoch
 Streuwert 3.98, horizontal: 4.15, vertikal: 3.80

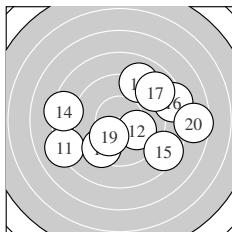

Serie 2:
 8.1 ↙ 10.0 ↘ 9.0 ↗ 8.4 ← 8.5 ↘
 8.4 → 8.9 ↗ 9.4 ↙ 10.1 ↙ 7.6 →
 beste Teiler 218.0 (19.) 226.2 (12.) 377.2 (18.)
 Trefferlage 1.18 mm rechts, 0.24 mm tief
 Streuwert 4.10, horizontal: 5.08, vertikal: 2.80

Unterschrift des Schuetzen

Ergebnis: **197.7** (188)
 Serien: 99.0 98.7
 Zaehler: 8 12 0 0 0 0 0 0 0 0
 Innenzehner: 5
 weiteste: 391 (16), 388 (1), 385 (3)
 beste Teiler 91.0 (9.) 131.7 (4.) 154.5 (10.)
 Trefferlage 0.18 mm rechts, 0.94 mm hoch
 Streuwert 1.90, horizontal: 2.26, vertikal: 1.45

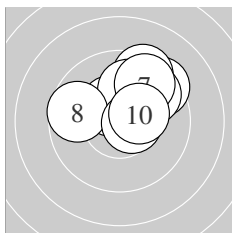
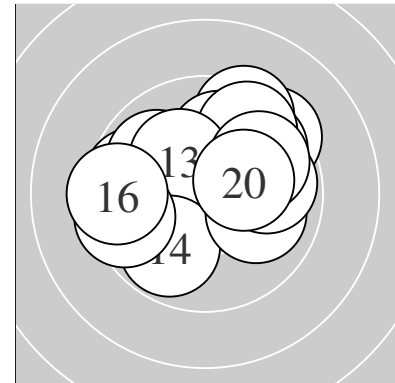

Serie 1:
 9.4 ↗ 9.9 ↗ 9.4 ↗ 10.4 * 10.0 ↑
 9.7 ↗ 9.6 ↗ 9.7 ← 10.6 * 10.3 *
 beste Teiler 91.0 (9.) 131.7 (4.) 154.5 (10.)
 Trefferlage 0.90 mm rechts, 1.78 mm hoch
 Streuwert 1.47, horizontal: 1.73, vertikal: 1.15

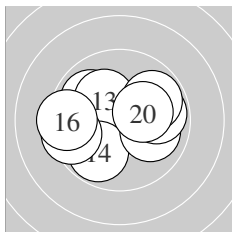

Serie 2:
 10.1 ← 9.9 ↘ 10.2 * 9.8 ✓ 9.5 ←
 9.4 ← 10.0 → 9.8 → 9.8 ↗ 10.2 *
 beste Teiler 182.4 (20.) 190.2 (13.) 215.9 (11.)
 Trefferlage 0.53 mm links, 0.11 mm hoch
 Streuwert 2.02, horizontal: 2.57, vertikal: 1.26

Unterschrift des Schuetzen

Ergebnis: **193.4** (187)
 Serien: 97.2 96.2
 Zaehler: 10 7 3 0 0 0 0 0 0 0
 Innenzehner: 5
 weiteste: 661 (8), 644 (12), 514 (14)
 beste Teiler 72.1 (13.) 145.4 (15.) 162.1 (18.)
 Trefferlage 2.08 mm links, 0.44 mm tief
 Streuwert 2.11, horizontal: 2.57, vertikal: 1.51

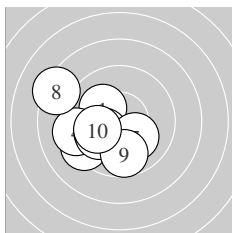
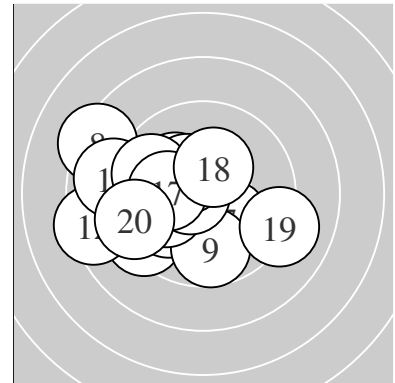

Serie 1:
 10.2 * 9.3 ↙ 10.2 * 9.3 ← 10.0 ←
 10.0 ↙ 10.1 ↘ 8.3 ↖ 9.7 ↓ 10.1 ←
 beste Teiler 178.1 (3.) 200.2 (1.) 205.7 (7.)
 Trefferlage 2.06 mm links, 0.80 mm tief
 Streuwert 1.92, horizontal: 2.11, vertikal: 1.70

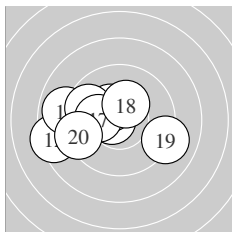

Serie 2:
 9.3 ← 8.4 ← 10.7 * 8.9 ← 10.4 *
 9.7 ↖ 10.1 ← 10.3 * 9.1 → 9.3 ←
 beste Teiler 72.1 (13.) 145.4 (15.) 162.1 (18.)
 Trefferlage 2.09 mm links, 0.08 mm tief
 Streuwert 2.36, horizontal: 3.08, vertikal: 1.27

Unterschrift des Schuetzen

Ergebnis: **185.6** (176)
 Serien: 92.9 92.7
 Zaehler: 6 7 5 1 1 0 0 0 0 0
 Innenzehner: 3
 weiteste: 1044 (13), 775 (20), 682 (16)
 beste Teiler 13.0 (12.) 119.5 (17.) 151.1 (15.)
 Trefferlage 0.05 mm rechts, 0.25 mm hoch
 Streuwert 3.50, horizontal: 4.48, vertikal: 2.10

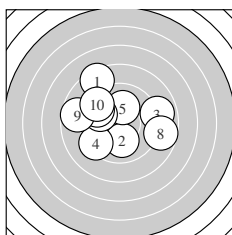
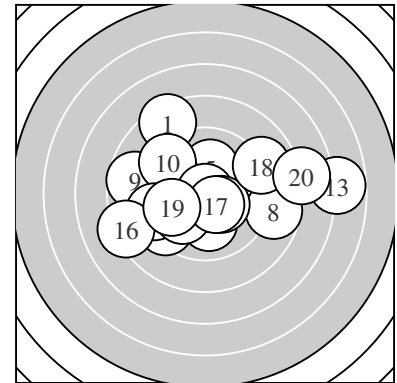

Serie 1:
 8.4 ↖ 10.0 ↓ 8.9 → 9.3 ↙ 10.1 ↑
 9.8 ↖ 9.6 ↖ 8.7 → 8.7 ← 9.4 ↖
 beste Teiler 209.0 (5.) 228.1 (2.) 280.1 (6.)
 Trefferlage 0.89 mm links, 0.92 mm hoch
 Streuwert 3.10, horizontal: 3.64, vertikal: 2.45

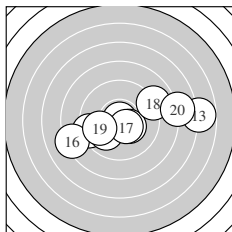

Serie 2:
 9.3 ← 10.9 * 6.8 → 10.0 ↙ 10.3 *
 8.2 ← 10.5 * 9.0 ↗ 9.8 ← 7.9 →
 beste Teiler 13.0 (12.) 119.5 (17.) 151.1 (15.)
 Trefferlage 0.99 mm rechts, 0.41 mm tief
 Streuwert 3.83, horizontal: 5.20, vertikal: 1.53

Unterschrift des Schuetzen

Ergebnis: **190.1** (182)
 Serien: 94.0 96.1
 Zaehler: 6 10 4 0 0 0 0 0 0 0
 Innenzehner: 5
 weiteste: 701 (17), 698 (12), 603 (4)
 beste Teiler 53.6 (2.) 95.0 (16.) 186.2 (14.)
 Trefferlage 0.16 mm rechts, 1.01 mm tief
 Streuwert 2.82, horizontal: 3.13, vertikal: 2.48

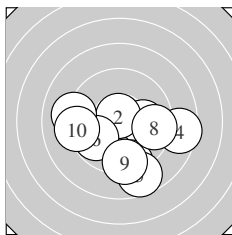
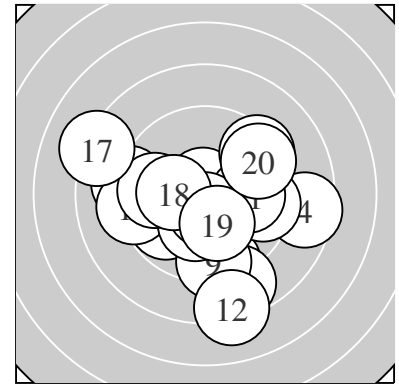

Serie 1:
 10.0 → 10.7 * 9.2 ↓ 8.5 → 8.7 ↓
 9.8 ↙ 9.1 ← 9.5 → 9.3 ↓ 9.2 ←
 beste Teiler 53.6 (2.) 233.3 (1.) 288.0 (6.)
 Trefferlage 0.41 mm rechts, 1.64 mm tief
 Streuwert 2.80, horizontal: 3.35, vertikal: 2.10

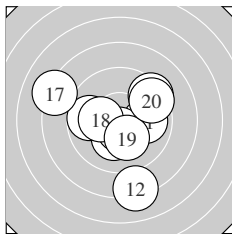

Serie 2:
 9.9 → 8.2 ↓ 9.4 ↗ 10.2 * 9.8 ←
 10.6 * 8.1 ↖ 10.2 * 10.2 * 9.5 ↗
 beste Teiler 95.0 (16.) 186.2 (14.) 187.1 (18.)
 Trefferlage 0.07 mm links, 0.39 mm tief
 Streuwert 2.92, horizontal: 3.05, vertikal: 2.77

Unterschrift des Schuetzen

Ergebnis: **172.4** (163)
 Serien: 85.1 87.3
 Zaehler: 3 9 3 3 0 1 0 0 1 0
 Innenzehner: 2
 weiteste: 2010 (6), 1290 (14), 909 (17)
 beste Teiler 21.9 (20.) 188.3 (11.) 226.8 (5.)
 Trefferlage 2.12 mm rechts, 0.52 mm hoch
 Streuwert 5.01, horizontal: 6.48, vertikal: 2.86

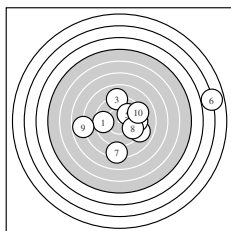
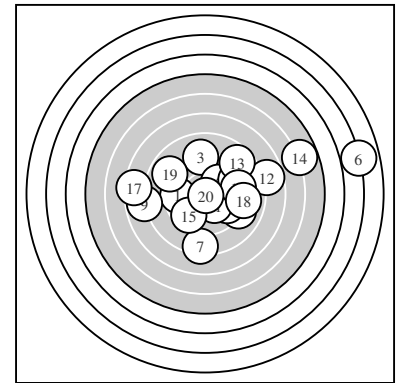

Serie 1:
 9.6 ← 9.0 ↘ 9.1 ↑ 9.5 → 10.0 ↗
 2.9 → 8.3 ↓ 9.7 ↘ 7.8 ← 9.2 →
 beste Teiler 226.8 (5.) 318.0 (8.) 347.4 (1.)
 Trefferlage 2.36 mm rechts, 0.08 mm hoch
 Streuwert 5.57, horizontal: 7.13, vertikal: 3.35

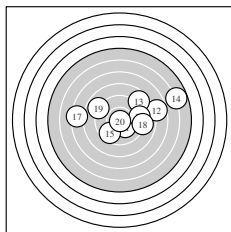

Serie 2:
 10.2 * 7.7 → 8.7 ↗ 5.8 → 9.6 ↗
 9.2 → 7.3 ← 9.0 → 8.9 ↖ 10.9 *
 beste Teiler 21.9 (20.) 188.3 (11.) 341.0 (15.)
 Trefferlage 1.87 mm rechts, 0.96 mm hoch
 Streuwert 4.65, horizontal: 6.13, vertikal: 2.37

Unterschrift des Schuetzen

Ergebnis: **197.7** (189)
 Serien: 97.6 100.1
 Zaehler: 9 11 0 0 0 0 0 0 0 0
 Innenzehner: 5
 weiteste: 416 (1), 410 (17), 393 (6)
 beste Teiler 72.8 (11.) 127.4 (5.) 142.0 (12.)
 Trefferlage 0.40 mm rechts, 0.19 mm hoch
 Streuwert 2.05, horizontal: 2.43, vertikal: 1.58

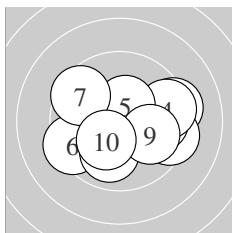
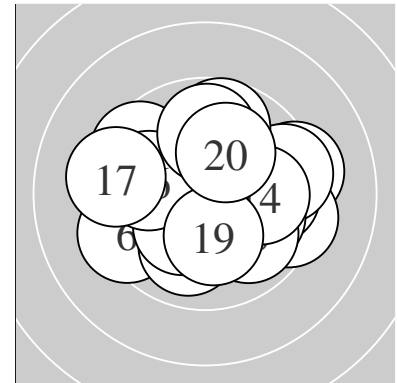

Serie 1:
 9.3 → 9.4 → 9.8 → 9.5 → 10.4 *
 9.4 ← 9.5 ↘ 10.0 ↓ 10.0 → 10.3 *
 beste Teiler 127.4 (5.) 174.2 (10.) 246.9 (8.)
 Trefferlage 0.87 mm rechts, 0.25 mm tief
 Streuwert 2.25, horizontal: 2.83, vertikal: 1.46

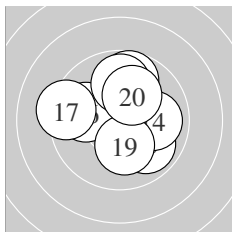

Serie 2:
 10.7 * 10.4 * 9.9 ↘ 10.0 → 9.7 ↑
 9.9 ← 9.3 ← 9.9 ↑ 10.2 * 10.1 ↗
 beste Teiler 72.8 (11.) 142.0 (12.) 191.8 (19.)
 Trefferlage 0.06 mm links, 0.64 mm hoch
 Streuwert 1.83, horizontal: 2.00, vertikal: 1.64

Unterschrift des Schuetzen

Ergebnis: **191.5** (183)
 Serien: 96.9 94.6
 Zaehler: 8 7 5 0 0 0 0 0 0 0
 Innenzehner: 4
 weiteste: 731 (13), 715 (5), 551 (17)
 beste Teiler 69.8 (2.) 93.0 (18.) 124.1 (11.)
 Trefferlage 0.46 mm rechts, 0.80 mm hoch
 Streuwert 2.77, horizontal: 3.76, vertikal: 1.10

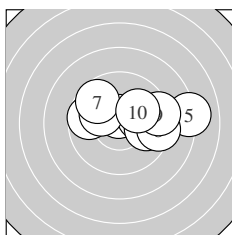
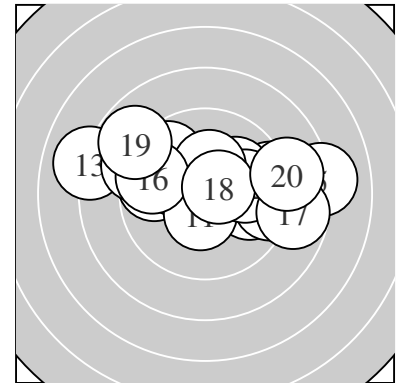

Serie 1:
 9.7 ← 10.7 * 10.1 → 10.1 ↖ 8.1 →
 9.8 → 9.7 ↘ 9.3 → 9.3 → 10.1 ↗
 beste Teiler 69.8 (2.) 207.6 (3.) 210.6 (4.)
 Trefferlage 1.42 mm rechts, 0.68 mm hoch
 Streuwert 2.37, horizontal: 3.25, vertikal: 0.83

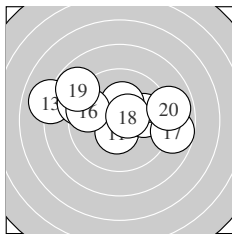

Serie 2:
 10.5 * 10.0 → 8.0 ← 10.3 * 9.2 ↖
 9.6 ← 8.7 → 10.6 * 8.8 ↖ 8.9 →
 beste Teiler 93.0 (18.) 124.1 (11.) 170.0 (14.)
 Trefferlage 0.50 mm links, 0.92 mm hoch
 Streuwert 3.08, horizontal: 4.15, vertikal: 1.35

Unterschrift des Schuetzen

Ergebnis: **162.7** (155)
 Serien: 78.6 84.1
 Zaehler: 2 5 4 6 1 2 0 0 0 0
 Innenzehner: 2
 weiteste: 1425 (18), 1424 (4), 1160 (2)
 beste Teiler 87.9 (13.) 153.7 (19.) 294.3 (20.)
 Trefferlage 1.57 mm links, 2.92 mm tief
 Streuwert 5.26, horizontal: 6.94, vertikal: 2.68

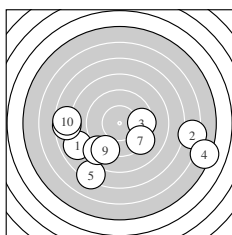
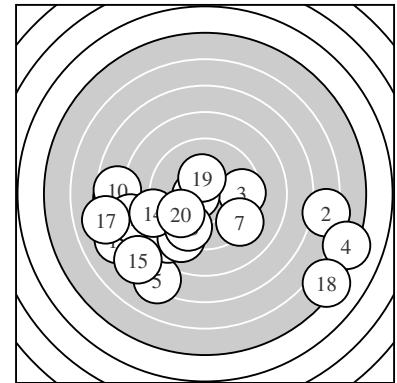

Serie 1:
 8.0 ↙ 6.3 → 9.6 → 5.3 ↘ 7.2 ↘
 7.6 ← 9.3 ↘ 8.7 ↙ 9.0 ↙ 7.6 ←
 beste Teiler 350.1 (3.) 423.0 (7.) 476.4 (9.)
 Trefferlage 0.19 mm links, 2.92 mm tief
 Streuwert 5.85, horizontal: 7.84, vertikal: 2.63

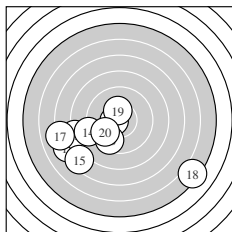

Serie 2:
 7.2 ↙ 8.0 ← 10.6 * 8.9 ↙ 7.4 ↙
 9.5 ↘ 7.1 ← 5.3 ↘ 10.3 * 9.8 ↙
 beste Teiler 87.9 (13.) 153.7 (19.) 294.3 (20.)
 Trefferlage 2.94 mm links, 2.91 mm tief
 Streuwert 4.70, horizontal: 6.00, vertikal: 2.86

Unterschrift des Schuetzen

Ergebnis: **187.7** (180)
 Serien: 93.2 94.5
 Zaehler: 9 7 2 0 1 1 0 0 0 0
 Innenzehner: 7
 weiteste: 1322 (8), 1214 (17), 700 (6)
 beste Teiler 58.2 (20.) 117.1 (10.) 141.2 (9.)
 Trefferlage 2.84 mm links, 0.22 mm tief
 Streuwert 3.11, horizontal: 4.02, vertikal: 1.77

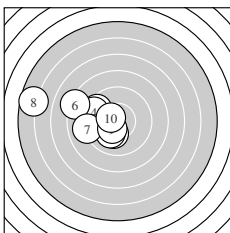
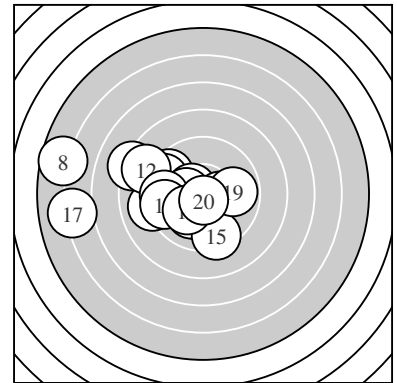

Serie 1:
 10.2 * 10.2 * 9.5 ↖ 9.4 ↖ 10.1 ↙
 8.2 ↖ 9.0 ← 5.7 ← 10.4 * 10.5 *
 beste Teiler 117.1 (10.) 141.2 (9.) 190.6 (1.)
 Trefferlage 3.51 mm links, 0.16 mm hoch
 Streuwert 3.05, horizontal: 3.85, vertikal: 1.95

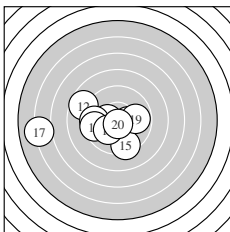

Serie 2:
 10.3 * 8.7 ↖ 10.3 * 9.5 ← 9.4 ↓
 9.5 ← 6.1 ← 10.1 ↗ 9.9 → 10.7 *
 beste Teiler 58.2 (20.) 154.5 (11.) 158.1 (13.)
 Trefferlage 2.17 mm links, 0.62 mm tief
 Streuwert 3.23, horizontal: 4.29, vertikal: 1.58

Unterschrift des Schuetzen

Ergebnis: **200.9** (194)
 Serien: 101.8 99.1
 Zaehler: 16 2 2 0 0 0 0 0 0 0
 Innenzehner: 11
 weiteste: 747 (11), 627 (16), 363 (2)
 beste Teiler 76.0 (3.) 76.9 (9.) 80.1 (4.)
 Trefferlage 0.19 mm links, 0.66 mm hoch
 Streuwert 2.00, horizontal: 2.76, vertikal: 0.61

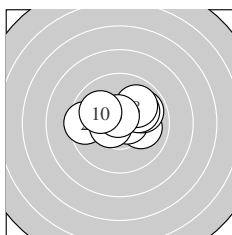
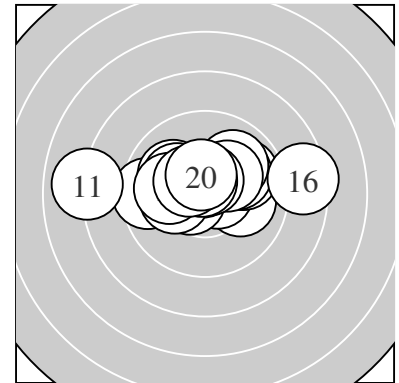

Serie 1:
 10.0 → 9.5 ← 10.6 * 10.6 * 10.6 *
 9.9 ↗ 10.0 ↗ 10.0 ↗ 10.6 * 10.0 ↖
 beste Teiler 76.0 (3.) 76.9 (9.) 80.1 (4.)
 Trefferlage 0.30 mm rechts, 0.58 mm hoch
 Streuwert 1.51, horizontal: 2.00, vertikal: 0.76

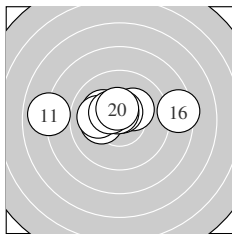

Serie 2:
 8.0 ← 10.2 * 10.2 * 10.0 ← 10.2 *
 8.4 → 10.6 * 10.6 * 10.4 * 10.5 *
 beste Teiler 82.9 (18.) 89.0 (17.) 122.5 (20.)
 Trefferlage 0.70 mm links, 0.74 mm hoch
 Streuwert 2.42, horizontal: 3.40, vertikal: 0.43

Unterschrift des Schuetzen

Ergebnis: **157.8** (149)
 Serien: 82.5 75.3
 Zaehler: 0 4 7 3 6 0 0 0 0 0
 Innenzehner: 0
 weiteste: 1221 (17), 1180 (1), 1136 (15)
 beste Teiler 310.5 (20.) 463.1 (5.) 467.7 (7.)
 Trefferlage 4.83 mm links, 4.69 mm hoch
 Streuwert 3.28, horizontal: 4.14, vertikal: 2.11

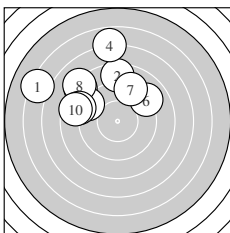
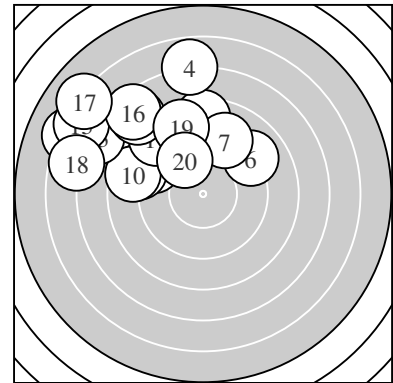

Serie 1:
 6.2 ↘ 8.5 ↑ 8.3 ↘ 6.8 ↑ 9.1 ↘
 9.0 ↗ 9.1 ↑ 8.1 ↘ 8.8 ↖ 8.6 ↖
 beste Teiler 463.1 (5.) 467.7 (7.) 483.6 (6.)
 Trefferlage 3.13 mm links, 4.34 mm hoch
 Streuwert 3.53, horizontal: 4.28, vertikal: 2.56

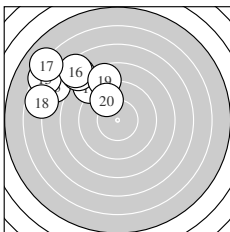

Serie 2:
 8.6 ↘ 6.9 ↘ 7.0 ↘ 7.7 ↘ 6.4 ↘
 7.5 ↘ 6.1 ↘ 6.7 ↖ 8.7 ↑ 9.7 ↘
 beste Teiler 310.5 (20.) 568.2 (19.) 589.8 (11.)
 Trefferlage 6.53 mm links, 5.05 mm hoch
 Streuwert 2.64, horizontal: 3.38, vertikal: 1.59

Unterschrift des Schuetzen

Ergebnis: **194.2** (184)
 Serien: 97.2 97.0
 Zaehler: 10 5 4 1 0 0 0 0 0 0
 Innenzehner: 8
 weiteste: 757 (13), 675 (6), 585 (16)
 beste Teiler 81.8 (17.) 97.1 (15.) 98.4 (8.)
 Trefferlage 1.02 mm links, 0.80 mm hoch
 Streuwert 2.54, horizontal: 3.40, vertikal: 1.15

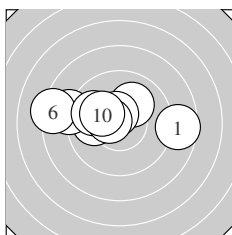
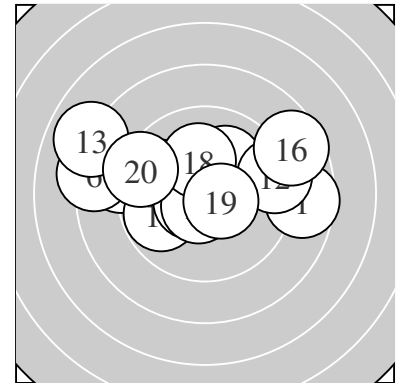

Serie 1:
 8.6 → 10.1 ↗ 9.9 ← 10.3 * 8.9 ←
 8.3 ← 9.8 ↖ 10.6 * 10.5 * 10.2 *
 beste Teiler 98.4 (8.) 103.8 (9.) 169.0 (4.)
 Trefferlage 1.43 mm links, 0.76 mm hoch
 Streuwert 2.44, horizontal: 3.39, vertikal: 0.65

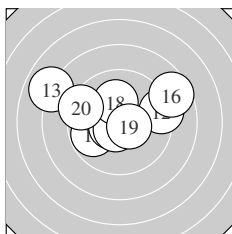

Serie 2:
 10.4 * 9.2 → 7.9 ↖ 9.8 ← 10.6 *
 8.6 ↗ 10.6 * 10.1 ↑ 10.5 * 9.3 ↖
 beste Teiler 81.8 (17.) 97.1 (15.) 104.2 (19.)
 Trefferlage 0.60 mm links, 0.83 mm hoch
 Streuwert 2.73, horizontal: 3.54, vertikal: 1.54

Unterschrift des Schuetzen

Ergebnis: **195.4** (187)
 Serien: 99.6 95.8
 Zaehler: 8 11 1 0 0 0 0 0 0 0
 Innenzehner: 5
 weiteste: 549 (16), 491 (5), 439 (13)
 beste Teiler 127.9 (8.) 141.7 (18.) 150.9 (10.)
 Trefferlage 1.48 mm links, 0.55 mm hoch
 Streuwert 2.04, horizontal: 2.47, vertikal: 1.49

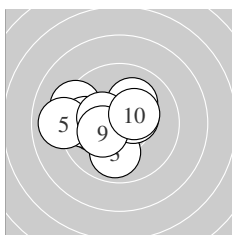
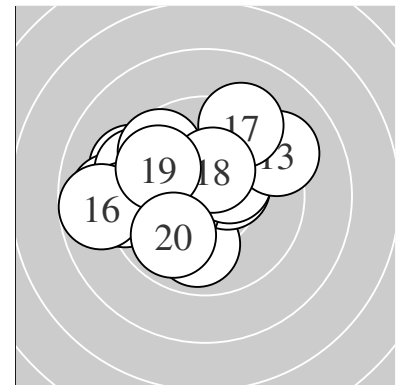

Serie 1:
 10.1 ← 9.3 ↖ 9.9 ↓ 9.8 ← 9.0 ←
 10.1 ↗ 10.3 * 10.4 * 10.3 * 10.4 *
 beste Teiler 127.9 (8.) 150.9 (10.) 160.6 (7.)
 Trefferlage 1.38 mm links, 0.16 mm hoch
 Streuwert 1.77, horizontal: 2.18, vertikal: 1.22

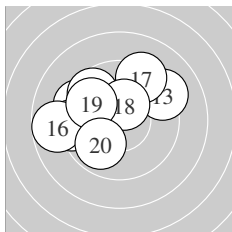

Serie 2:
 10.1 ← 9.4 ↖ 9.2 ↗ 9.6 ↘ 9.3 ←
 8.8 ← 9.3 ↗ 10.4 * 9.8 ↘ 9.9 ↘
 beste Teiler 141.7 (18.) 218.2 (11.) 265.9 (20.)
 Trefferlage 1.58 mm links, 0.94 mm hoch
 Streuwert 2.34, horizontal: 2.84, vertikal: 1.70

Unterschrift des Schuetzen

Ergebnis: **186.1** (178)
 Serien: 93.8 92.3
 Zaehler: 7 9 1 1 2 0 0 0 0 0
 Innenzehner: 6
 weiteste: 1210 (11), 1003 (10), 811 (9)
 beste Teiler 82.8 (2.) 106.8 (1.) 107.4 (8.)
 Trefferlage 0.43 mm links, 2.27 mm hoch
 Streuwert 3.25, horizontal: 3.04, vertikal: 3.44

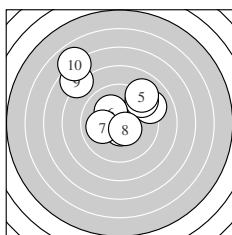
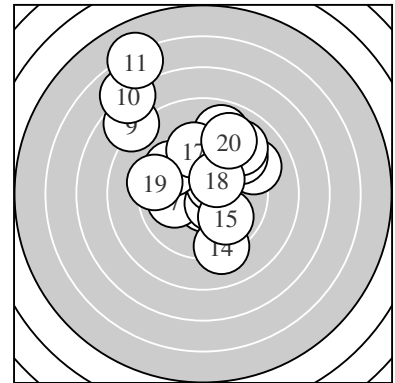

Serie 1:
 10.5 * 10.6 * 9.1 ↗ 9.3 ↗ 9.0 ↗
 10.2 * 10.0 ← 10.5 * 7.7 ↘ 6.9 ↘
 beste Teiler 82.8 (2.) 106.8 (1.) 107.4 (8.)
 Trefferlage 0.49 mm links, 2.30 mm hoch
 Streuwert 3.21, horizontal: 3.50, vertikal: 2.89

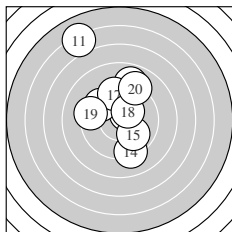

Serie 2:
 6.1 ↖ 10.5 * 8.9 ↑ 9.2 ↓ 9.9 ↘
 9.6 ↘ 9.5 ↑ 10.3 * 9.3 ← 9.0 ↑
 beste Teiler 118.2 (12.) 162.0 (18.) 260.9 (15.)
 Trefferlage 0.38 mm links, 2.24 mm hoch
 Streuwert 3.46, horizontal: 2.69, vertikal: 4.08

Unterschrift des Schuetzen

Ergebnis: **185.0** (176)
 Serien: 95.1 89.9
 Zaehler: 7 9 1 1 1 0 1 0 0 0
 Innenzehner: 4
 weiteste: 1521 (17), 1075 (5), 856 (18)
 beste Teiler 72.9 (8.) 151.6 (4.) 187.5 (19.)
 Trefferlage 1.39 mm rechts, 0.25 mm hoch
 Streuwert 3.84, horizontal: 5.16, vertikal: 1.70

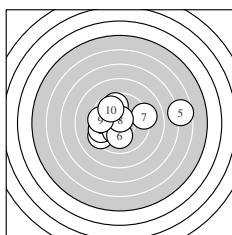
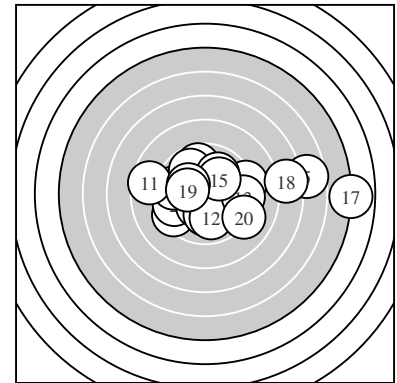

Serie 1:
 9.4 ↙ 9.6 ← 9.7 ↑ 10.3 * 6.7 →
 10.1 ↓ 9.2 → 10.7 * 9.6 ← 9.8 ↘
 beste Teiler 72.9 (8.) 151.6 (4.) 214.0 (6.)
 Trefferlage 0.21 mm rechts, 0.31 mm hoch
 Streuwert 3.31, horizontal: 4.29, vertikal: 1.89

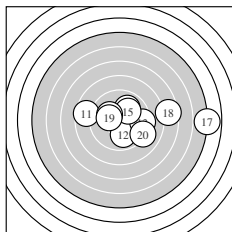

Serie 2:
 8.6 ← 9.9 ↓ 9.4 → 10.0 ↗ 10.1 ↗
 10.2 * 4.9 → 7.5 → 10.2 * 9.1 ↘
 beste Teiler 187.5 (19.) 199.6 (16.) 213.6 (15.)
 Trefferlage 2.57 mm rechts, 0.20 mm hoch
 Streuwert 4.32, horizontal: 5.90, vertikal: 1.59

Unterschrift des Schuetzen

Ergebnis: **176.6** (167)
 Serien: 93.0 83.6
 Zaehler: 5 5 6 1 2 1 0 0 0 0
 Innenzehner: 4
 weiteste: 1398 (12), 1168 (17), 1033 (4)
 beste Teiler 22.0 (1.) 67.1 (7.) 111.7 (3.)
 Trefferlage 2.60 mm links, 0.96 mm tief
 Streuwert 4.26, horizontal: 5.84, vertikal: 1.51

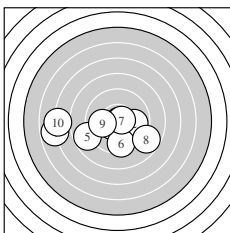
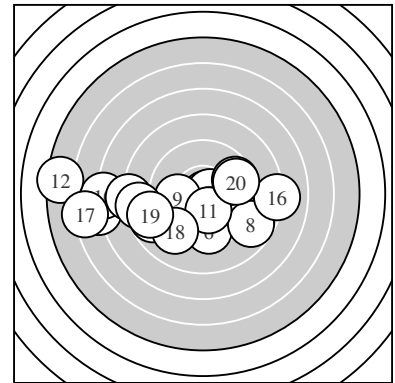

Serie 1:
 10.9 * 9.9 → 10.5 * 6.8 ← 8.8 ←
 9.5 ↓ 10.7 * 8.8 ↘ 10.0 ← 7.1 ←
 beste Teiler 22.0 (1.) 67.1 (7.) 111.7 (3.)
 Trefferlage 1.92 mm links, 1.21 mm tief
 Streuwert 3.63, horizontal: 4.96, vertikal: 1.36

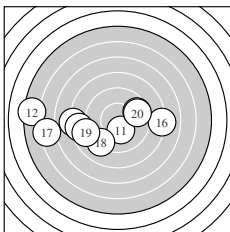

Serie 2:
 10.3 * 5.4 ← 8.1 ← 8.4 ← 9.6 →
 8.1 → 6.3 ← 9.1 ↙ 8.7 ← 9.6 →
 beste Teiler 168.2 (11.) 340.2 (15.) 343.2 (20.)
 Trefferlage 3.27 mm links, 0.70 mm tief
 Streuwert 4.96, horizontal: 6.81, vertikal: 1.67

Unterschrift des Schuetzen

Ergebnis: **196.1** (187)
 Serien: 95.2 100.9
 Zaehler: 8 11 1 0 0 0 0 0 0 0
 Innenzehner: 6
 weiteste: 736 (1), 472 (3), 437 (19)
 beste Teiler 100.2 (11.) 110.9 (18.) 151.1 (12.)
 Trefferlage 0.51 mm links, 1.00 mm hoch
 Streuwert 2.19, horizontal: 2.54, vertikal: 1.77

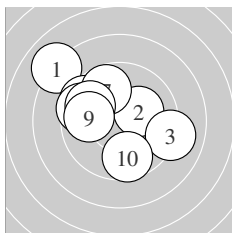
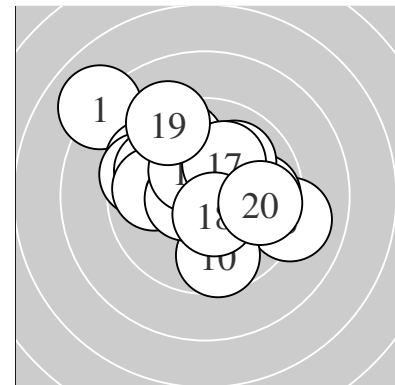

Serie 1:
 8.0 ↘ 10.2 * 9.1 → 9.8 ↖ 9.5 ↖
 9.5 ↖ 9.7 ↖ 9.8 ↖ 9.9 ← 9.7 ↓
 beste Teiler 190.9 (2.) 275.7 (9.) 296.0 (8.)
 Trefferlage 1.45 mm links, 0.98 mm hoch
 Streuwert 2.59, horizontal: 2.97, vertikal: 2.14

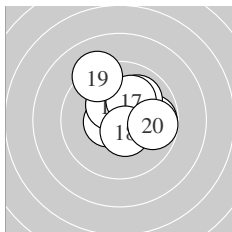

Serie 2:
 10.6 * 10.3 * 9.8 → 10.0 ↗ 10.3 *
 10.3 * 10.1 ↗ 10.5 * 9.2 ↖ 9.8 →
 beste Teiler 100.2 (11.) 110.9 (18.) 151.1 (12.)
 Trefferlage 0.43 mm rechts, 1.02 mm hoch
 Streuwert 1.55, horizontal: 1.67, vertikal: 1.43

Unterschrift des Schuetzen

Ergebnis: **190.3** (181)
 Serien: 92.4 97.9
 Zaehler: 7 10 1 1 1 0 0 0 0 0
 Innenzehner: 6
 weiteste: 1177 (1), 998 (8), 521 (15)
 beste Teiler 69.6 (4.) 105.1 (11.) 114.1 (9.)
 Trefferlage 0.21 mm links, 1.22 mm hoch
 Streuwert 3.15, horizontal: 4.22, vertikal: 1.45

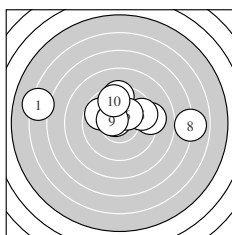
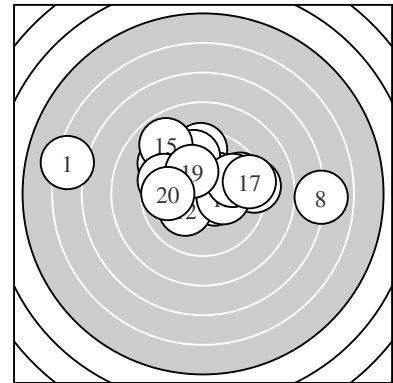

Serie 1:
 6.2 ← 9.2 → 9.5 ↑ 10.7 * 9.6 →
 10.3 * 9.8 ↙ 7.0 → 10.5 * 9.6 ↑
 beste Teiler 69.6 (4.) 114.1 (9.) 165.5 (6.)
 Trefferlage 0.16 mm rechts, 1.46 mm hoch
 Streuwert 3.98, horizontal: 5.48, vertikal: 1.31

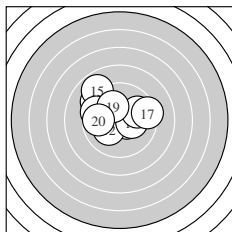

Serie 2:
 10.5 * 10.2 * 10.3 * 9.3 ↘ 8.9 ↘
 9.9 → 9.3 → 9.6 ← 10.1 ↖ 9.8 ←
 beste Teiler 105.1 (11.) 172.9 (13.) 198.6 (12.)
 Trefferlage 0.60 mm links, 0.99 mm hoch
 Streuwert 2.22, horizontal: 2.69, vertikal: 1.61

Unterschrift des Schuetzen

Ergebnis: **184.2** (176)
 Serien: 91.6 92.6
 Zaehler: 6 8 4 1 0 1 0 0 0 0
 Innenzehner: 4
 weiteste: 1345 (2), 796 (4), 747 (13)
 beste Teiler 77.8 (5.) 147.7 (7.) 164.8 (11.)
 Trefferlage 0.24 mm links, 1.57 mm hoch
 Streuwert 3.62, horizontal: 4.86, vertikal: 1.64

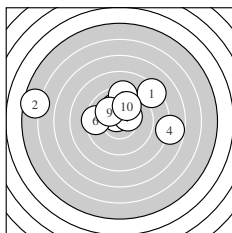
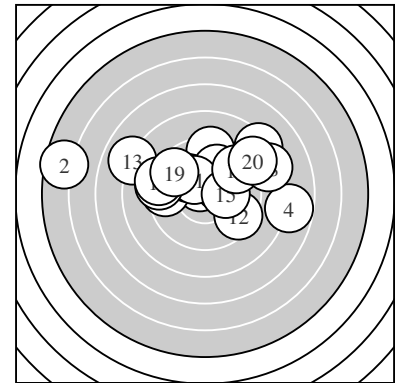

Serie 1:
 8.3 ↗ 5.6 ← 10.1 ↖ 7.8 → 10.6 *
 9.5 ← 10.4 * 9.3 ↑ 10.1 ↖ 9.9 ↗
 beste Teiler 77.8 (5.) 147.7 (7.) 214.3 (9.)
 Trefferlage 0.39 mm links, 1.71 mm hoch
 Streuwert 4.13, horizontal: 5.56, vertikal: 1.76

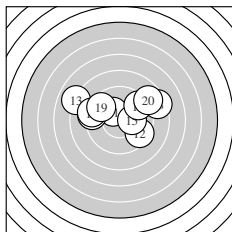

Serie 2:
 10.3 * 9.5 ↘ 8.0 ↙ 9.2 ← 10.2 *
 9.5 ↗ 9.2 ← 8.4 → 9.5 ↘ 8.8 ↗
 beste Teiler 164.8 (11.) 193.0 (15.) 351.5 (19.)
 Trefferlage 0.09 mm links, 1.43 mm hoch
 Streuwert 3.26, horizontal: 4.33, vertikal: 1.58

Unterschrift des Schuetzen

Ergebnis: **183.1** (176)
 Serien: 89.2 93.9
 Zaehler: 6 7 5 1 1 0 0 0 0 0
 Innenzehner: 2
 weiteste: 1236 (1), 758 (8), 717 (20)
 beste Teiler 114.2 (6.) 168.6 (17.) 209.9 (12.)
 Trefferlage 0.61 mm links, 0.52 mm tief
 Streuwert 3.71, horizontal: 4.90, vertikal: 1.89

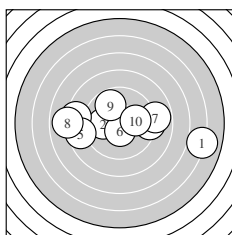
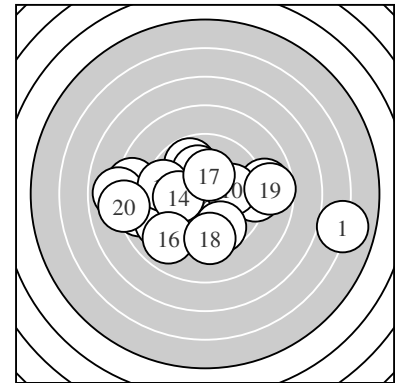

Serie 1:
 6.0 → 10.0 ← 8.4 ← 9.2 → 8.6 ←
 10.5 * 8.8 → 7.9 ← 9.8 ↖ 10.0 →
 beste Teiler 114.2 (6.) 235.2 (10.) 239.1 (2.)
 Trefferlage 0.06 mm rechts, 0.08 mm tief
 Streuwert 4.44, horizontal: 6.10, vertikal: 1.50

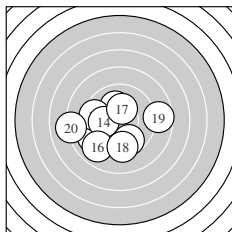

Serie 2:
 9.1 ↙ 10.1 ↖ 9.5 ← 10.0 ← 9.7 ↘
 9.0 ↙ 10.3 * 9.4 ↓ 8.7 → 8.1 ←
 beste Teiler 168.6 (17.) 209.9 (12.) 233.4 (14.)
 Trefferlage 1.30 mm links, 0.96 mm tief
 Streuwert 2.95, horizontal: 3.53, vertikal: 2.21

Unterschrift des Schuetzen

Ergebnis: **183.4** (173)
 Serien: 91.9 91.5
 Zaehler: 6 7 4 2 0 0 1 0 0 0
 Innenzehner: 4
 weiteste: 1612 (9), 908 (18), 773 (17)
 beste Teiler 25.6 (6.) 99.8 (4.) 143.5 (14.)
 Trefferlage 2.20 mm rechts, 0.32 mm hoch
 Streuwert 3.76, horizontal: 4.89, vertikal: 2.09

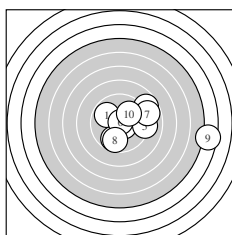
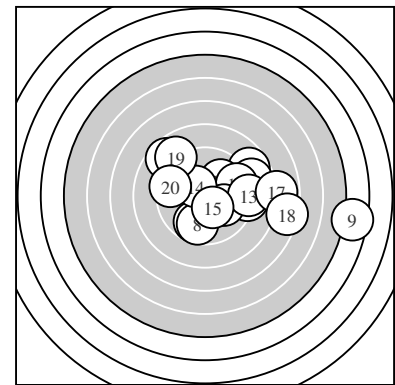

Serie 1:
 9.9 ↘ 8.7 ↗ 9.7 ↓ 10.6 * 9.1 →
 10.9 * 8.8 → 9.7 ↓ 4.5 → 10.0 ↗
 beste Teiler 25.6 (6.) 99.8 (4.) 240.4 (10.)
 Trefferlage 2.86 mm rechts, 0.12 mm tief
 Streuwert 4.03, horizontal: 5.28, vertikal: 2.14

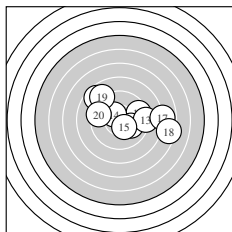

Serie 2:
 9.5 → 10.0 ↘ 9.1 → 10.4 * 10.4 *
 8.6 ↘ 7.9 → 7.3 → 8.9 ↘ 9.4 ←
 beste Teiler 143.5 (14.) 148.6 (15.) 226.7 (12.)
 Trefferlage 1.54 mm rechts, 0.78 mm hoch
 Streuwert 3.60, horizontal: 4.66, vertikal: 2.05

Unterschrift des Schuetzen

Ergebnis: **182.2** (173)
 Serien: 92.5 89.7
 Zaehler: 3 9 6 2 0 0 0 0 0 0
 Innenzehner: 2
 weiteste: 883 (20), 770 (5), 651 (8)
 beste Teiler 154.6 (4.) 186.0 (7.) 223.2 (6.)
 Trefferlage 1.77 mm links, 1.98 mm hoch
 Streuwert 3.01, horizontal: 3.62, vertikal: 2.25

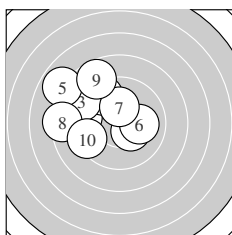
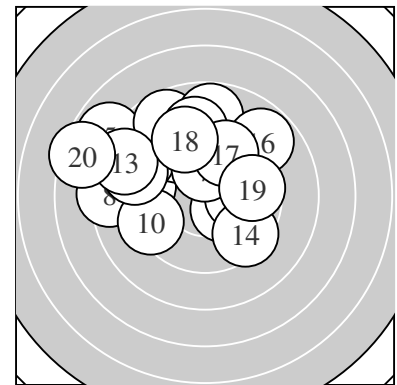

Serie 1:
 9.2 ← 9.5 ↘ 9.0 ↙ 10.3 * 7.9 ↘
 10.1 → 10.2 * 8.3 ← 8.7 ↗ 9.3 ←
 beste Teiler 154.6 (4.) 186.0 (7.) 223.2 (6.)
 Trefferlage 2.63 mm links, 1.46 mm hoch
 Streuwert 2.66, horizontal: 3.03, vertikal: 2.22

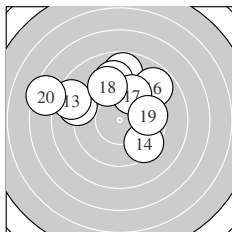

Serie 2:
 8.8 ↑ 8.9 ↙ 8.6 ↙ 9.4 ↘ 9.1 ↑
 8.8 ↗ 9.7 ↗ 9.3 ↘ 9.7 → 7.4 ↙
 beste Teiler 321.5 (17.) 325.5 (19.) 376.3 (14.)
 Trefferlage 0.92 mm links, 2.51 mm hoch
 Streuwert 3.31, horizontal: 4.10, vertikal: 2.27

Unterschrift des Schuetzen

Ergebnis: **0.0** (0)_{DNS}

Serien:

Zaehler: 0 0 0 0 0 0 0 0 0 0

Innenzehner: 0

weiteste:

~~beste Teiler~~ – Schütze ist nicht zum Wettkampf angetreten

Trefferlage 0.00 mm , 0.00 mm

Streuwert

Unterschrift des Schuetzen

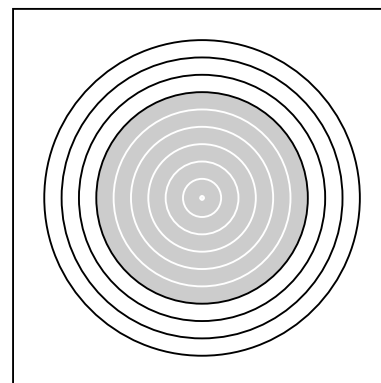

Ergebnis: **171.9** (163)
 Serien: 89.2 82.7
 Zaehler: 4 5 8 1 0 1 0 0 1 0
 Innenzehner: 3
 weiteste: 2113 (20), 1318 (16), 767 (9)
 beste Teiler 100.9 (12.) 117.3 (18.) 188.2 (17.)
 Trefferlage 1.92 mm rechts, 2.00 mm tief
 Streuwert 4.95, horizontal: 6.51, vertikal: 2.57

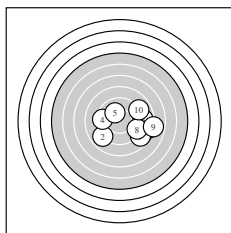
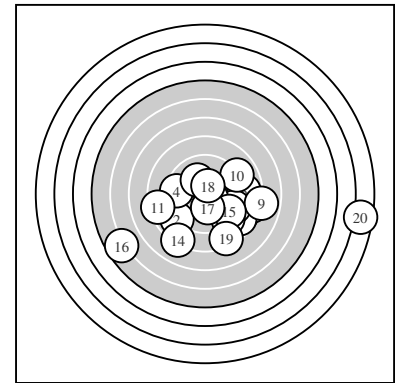

Serie 1:
 8.7 ↘ 8.9 ↙ 8.4 → 9.4 ← 10.1 ↖
 8.9 → 8.7 ↘ 9.2 ↘ 7.9 → 9.0 ↗
 beste Teiler 213.9 (5.) 384.3 (4.) 430.1 (8.)
 Trefferlage 2.82 mm rechts, 0.90 mm tief
 Streuwert 3.28, horizontal: 4.13, vertikal: 2.12

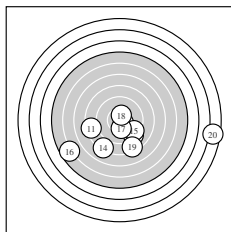

Serie 2:
 8.3 ← 10.6 * 9.1 ↘ 8.1 ↙ 9.4 ↘
 5.7 ↙ 10.2 * 10.5 * 8.3 ↘ 2.5 →
 beste Teiler 100.9 (12.) 117.3 (18.) 188.2 (17.)
 Trefferlage 1.03 mm rechts, 3.10 mm tief
 Streuwert 6.22, horizontal: 8.40, vertikal: 2.60

Unterschrift des Schuetzen

Ergebnis: **186.8** (178)
 Serien: 93.1 93.7
 Zaehler: 6 8 4 2 0 0 0 0 0 0
 Innenzehner: 4
 weiteste: 990 (14), 966 (11), 686 (2)
 beste Teiler 37.0 (13.) 71.7 (5.) 118.1 (17.)
 Trefferlage 1.40 mm links, 1.66 mm hoch
 Streuwert 3.10, horizontal: 4.01, vertikal: 1.75

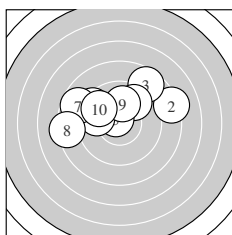
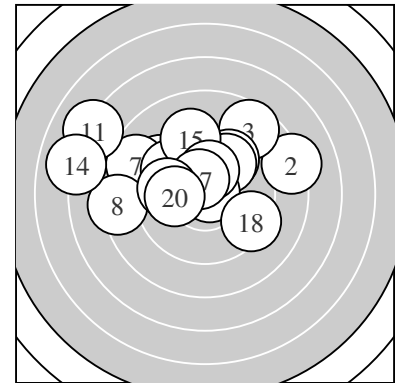

Serie 1:
 9.4 ↘ 8.2 → 8.6 ↗ 9.7 ↗ 10.7 *
 9.8 ← 8.7 ← 8.3 ← 10.0 ↑ 9.7 ↘
 beste Teiler 71.7 (5.) 244.5 (9.) 291.5 (6.)
 Trefferlage 0.90 mm links, 1.86 mm hoch
 Streuwert 3.02, horizontal: 4.00, vertikal: 1.50

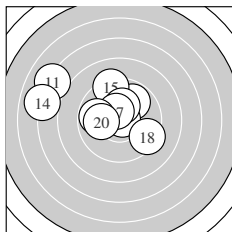

Serie 2:
 7.1 ↘ 9.8 ↗ 10.8 * 7.0 ← 9.2 ↑
 10.2 * 10.5 * 9.3 ↘ 9.8 ← 10.0 ←
 beste Teiler 37.0 (13.) 118.1 (17.) 178.7 (16.)
 Trefferlage 1.89 mm links, 1.45 mm hoch
 Streuwert 3.29, horizontal: 4.18, vertikal: 2.04

Unterschrift des Schuetzen

LG 20 ZR – Wertung – Jugend_I_männl.

StandNr: 109

Walder,, Gabriel #70606054

StartNr: 56

11. Maerz 2017 10:00

SG_Innervillgraten

Ergebnis: **0.0** (0)_{DNS}

Serien:

Zaehler: 0 0 0 0 0 0 0 0 0 0

Innenzehner: 0

weiteste:

~~beste Teiler~~ – Schütze ist nicht zum Wettkampf angetreten

Trefferlage 0.00 mm , 0.00 mm

Streuwert

Unterschrift des Schuetzen

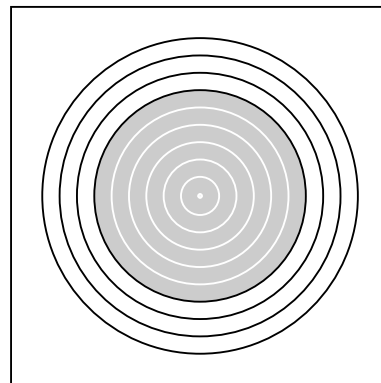

Ergebnis: **204.1** (195)
 Serien: 102.5 101.6
 Zaehler: 15 5 0 0 0 0 0 0 0 0
 Innenzehner: 12
 weiteste: 378 (15), 310 (19), 303 (16)
 beste Teiler 32.3 (18.) 81.4 (17.) 100.2 (12.)
 Trefferlage 0.00 mm , 0.27 mm hoch
 Streuwert 1.48, horizontal: 2.00, vertikal: 0.59

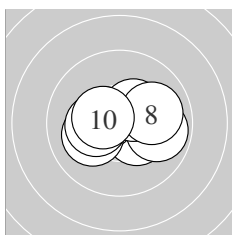
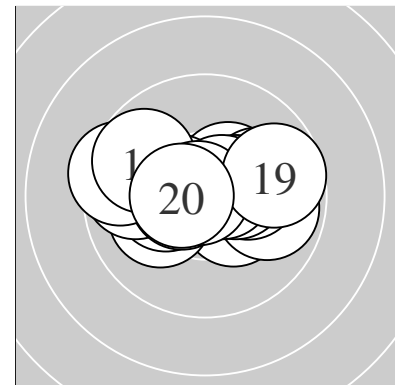

Serie 1:
 10.4 * 10.4 * 10.5 * 10.1 → 10.1 ←
 9.9 → 10.4 * 10.0 → 10.3 * 10.4 *
 beste Teiler 112.2 (3.) 126.4 (10.) 136.5 (7.)
 Trefferlage 0.47 mm rechts, 0.05 mm hoch
 Streuwert 1.32, horizontal: 1.76, vertikal: 0.63

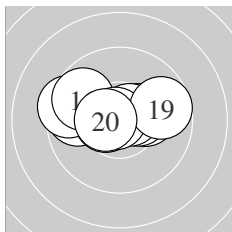

Serie 2:
 9.7 ← 10.6 * 10.2 * 10.4 * 9.4 ←
 9.7 ↖ 10.6 * 10.8 * 9.7 → 10.5 *
 beste Teiler 32.3 (18.) 81.4 (17.) 100.2 (12.)
 Trefferlage 0.47 mm links, 0.49 mm hoch
 Streuwert 1.60, horizontal: 2.20, vertikal: 0.49

Unterschrift des Schuetzen

Ergebnis: **193.8** (187)
 Serien: 98.5 95.3
 Zaehler: 10 8 1 1 0 0 0 0 0 0
 Innenzehner: 6
 weiteste: 849 (14), 532 (20), 469 (1)
 beste Teiler 86.1 (7.) 101.1 (16.) 150.7 (3.)
 Trefferlage 1.23 mm links, 0.01 mm hoch
 Streuwert 2.45, horizontal: 2.93, vertikal: 1.85

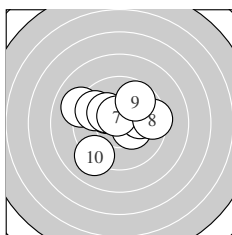
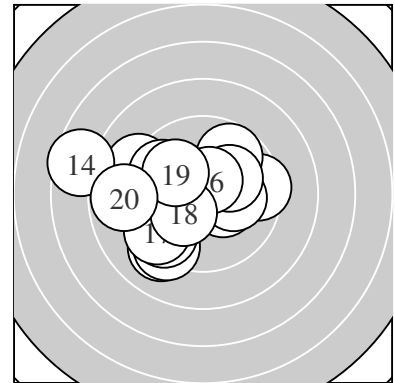

Serie 1:
 9.1 ↖ 10.2 * 10.4 * 10.0 → 9.7 ↖
 10.2 * 10.6 * 9.5 → 9.7 ↗ 9.1 ↙
 beste Teiler 86.1 (7.) 150.7 (3.) 178.2 (2.)
 Trefferlage 0.39 mm links, 0.54 mm hoch
 Streuwert 2.19, horizontal: 2.60, vertikal: 1.69

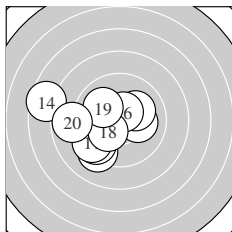

Serie 2:
 10.1 → 9.2 ↙ 10.1 ↗ 7.6 ↖ 9.4 ↙
 10.5 * 9.4 ↙ 10.2 * 10.0 ↖ 8.8 ←
 beste Teiler 101.1 (16.) 181.7 (18.) 206.6 (11.)
 Trefferlage 2.06 mm links, 0.50 mm tief
 Streuwert 2.61, horizontal: 3.14, vertikal: 1.94

Unterschrift des Schuetzen

LG 20 ZR – Wertung – Jugend_I_männl.

StandNr: 112

Feltrin,, Julian #70302085

StartNr: 59

11. Maerz 2017 10:08

SG_Fieberbrunn

Ergebnis: **0.0** (0)_{DNS}

Serien:

Zaehler: 0 0 0 0 0 0 0 0 0 0

Innenzehner: 0

weiteste:

~~beste Teiler~~ – Schütze ist nicht zum Wettkampf angetreten

Trefferlage 0.00 mm , 0.00 mm

Streuwert

Unterschrift des Schuetzen

