

Ergebnis: **198.9** (188)  
 Serien: 100.4 98.5  
 Zähler: 9 10 1 0 0 0 0 0 0 0  
 Innenzehner: 9  
 Weitester: 523 (19.), 452 (4.), 421 (17.)  
 beste Teiler: 47.2 (2.), 77.1 (14.), 77.2 (10.)  
 Trefferlage: 0.32 mm links, 0.69 mm tief  
 Streuwert: 2.00, horizontal: 2.69, vertikal: 0.90

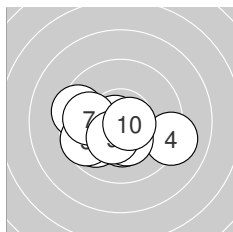
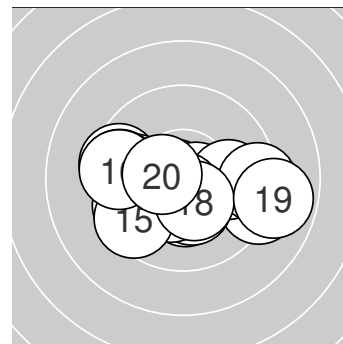

**Serie 1:**

9.5 ←	10.8 *	9.9 ↙	9.1 →	9.7 ↙
10.3 *	9.9 ←	10.3 *	10.3 *	10.6 *

beste Teiler: 47.2 (2.), 77.2 (10.), 152.5 (9.)  
 Trefferlage: 0.67 mm links, 0.83 mm tief  
 Streuwert: 1.76, horizontal: 2.31, vertikal: 0.93

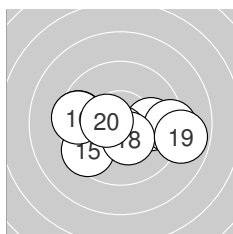

**Serie 2:**

9.5 ←	10.4 *	9.9 →	10.6 *	9.5 ↙
9.5 ←	9.3 →	10.4 *	8.9 →	10.5 *

beste Teiler: 77.1 (14.), 119.8 (20.), 139.7 (12.)  
 Trefferlage: 0.02 mm rechts, 0.55 mm tief  
 Streuwert: 2.28, horizontal: 3.11, vertikal: 0.89



**Ergebnis:** **200.6** (190)  
**Serien:** 102.5 98.1  
**Zähler:** 13 5 1 1 0 0 0 0 0 0  
**Innenzehner:** 12  
**Weiteste:** 852 (15.), 613 (11.), 364 (7.)  
**beste Teiler:** 17.0 (4.), 30.8 (13.), 66.8 (8.)  
**Trefferlage:** 0.69 mm rechts, 0.17 mm tief  
**Streuwert:** 2.14, horizontal: 2.82, vertikal: 1.08

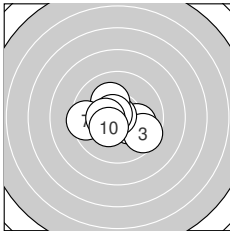
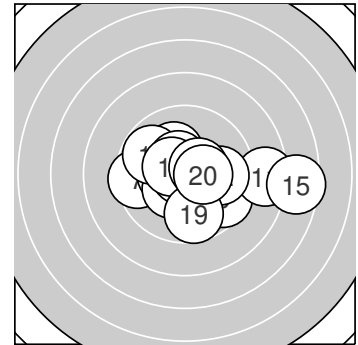

**Serie 1:**

10.3 *	10.0 →	9.6 ↘	10.9 *	10.2 *
10.6 *	9.5 ←	10.7 *	10.4 *	10.3 *

**beste Teiler:** 17.0 (4.), 66.8 (8.), 97.7 (6.)  
**Trefferlage:** 0.20 mm links, 0.29 mm tief  
**Streuwert:** 1.51, horizontal: 1.91, vertikal: 0.96

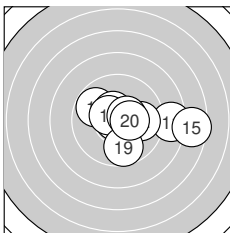

**Serie 2:**

8.5 →	9.9 →	10.8 *	9.8 ↖	7.5 →
10.5 *	10.5 *	10.5 *	9.7 ↓	10.4 *

**beste Teiler:** 30.8 (13.), 114.9 (18.), 115.9 (17.)  
**Trefferlage:** 1.60 mm rechts, 0.06 mm tief  
**Streuwert:** 2.54, horizontal: 3.37, vertikal: 1.23



Ergebnis: **193.9** (184)  
 Serien: 95.4 98.5  
 Zähler: 8 8 4 0 0 0 0 0 0 0  
 Innenzehner: 5  
 Weitester: 583 (7.), 550 (3.), 542 (11.)  
 beste Teiler: 67.2 (12.), 158.5 (2.), 161.5 (18.)  
 Trefferlage: 0.65 mm links, 0.72 mm hoch  
 Streuwert: 2.40, horizontal: 3.12, vertikal: 1.33

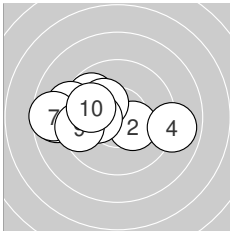
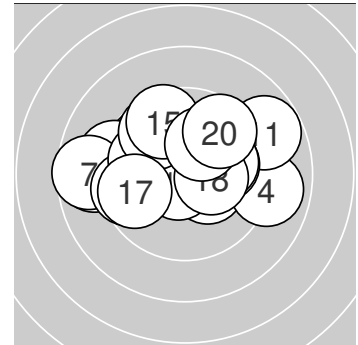

**Serie 1:**

9.8 ↘	10.3 *	8.8 ←	8.9 →	9.2 ←
10.2 *	8.6 ←	10.2 *	9.5 ←	9.9 ↖

beste Teiler: 158.5 (2.), 179.6 (6.), 182.3 (8.)  
 Trefferlage: 2.06 mm links, 0.23 mm hoch  
 Streuwert: 2.40, horizontal: 3.25, vertikal: 0.96

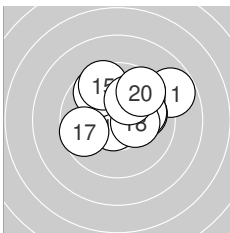

**Serie 2:**

8.8 ↗	10.7 *	9.7 ↘	10.0 →	9.6 ↖
10.0 →	9.7 ←	10.3 *	10.1 ↗	9.6 ↗

beste Teiler: 67.2 (12.), 161.5 (18.), 209.5 (19.)  
 Trefferlage: 0.74 mm rechts, 1.21 mm hoch  
 Streuwert: 1.98, horizontal: 2.36, vertikal: 1.51



Ergebnis: **197.6** (189)  
 Serien: 98.1 99.5  
 Zähler: 10 9 1 0 0 0 0 0 0 0  
 Innenzehner: 7  
 Weitestе: 538 (8.), 482 (20.), 481 (4.)  
 beste Teiler: 75.6 (15.), 76.6 (9.), 91.4 (7.)  
 Trefferlage: 0.17 mm links, 0.99 mm tief  
 Streuwert: 2.06, horizontal: 2.35, vertikal: 1.73

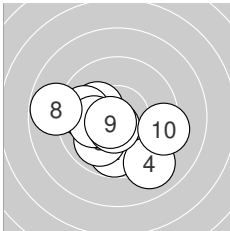
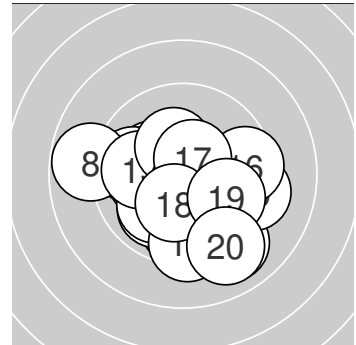

**Serie 1:**

10.2 *	9.8 ↓	9.9 ↙	9.0 ↘	9.8 ←
10.1 ←	10.6 *	8.8 ←	10.6 *	9.3 →

beste Teiler: 76.6 (9.), 91.4 (7.), 193.6 (1.)  
 Trefferlage: 0.80 mm links, 0.96 mm tief  
 Streuwert: 2.19, horizontal: 2.67, vertikal: 1.58

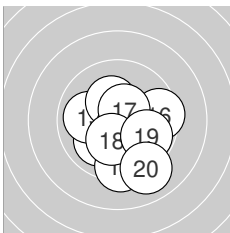

**Serie 2:**

10.0 ↗	9.4 ↓	10.0 ←	10.3 *	10.7 *
9.5 →	10.5 *	10.3 *	9.8 ↘	9.0 ↘

beste Teiler: 75.6 (15.), 106.0 (17.), 168.8 (14.)  
 Trefferlage: 0.46 mm rechts, 1.03 mm tief  
 Streuwert: 1.93, horizontal: 1.91, vertikal: 1.95



Ergebnis: **186.6** (177)  
 Serien: 90.6 96.0  
 Zähler: 5 8 6 1 0 0 0 0 0 0  
 Innenzehner: 4  
 Weitester: 910 (3.), 660 (9.), 542 (4.)  
 beste Teiler: 50.3 (17.), 70.6 (20.), 144.4 (10.)  
 Trefferlage: 0.30 mm rechts, 1.30 mm hoch  
 Streuwert: 3.15, horizontal: 4.14, vertikal: 1.66

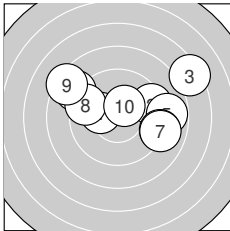
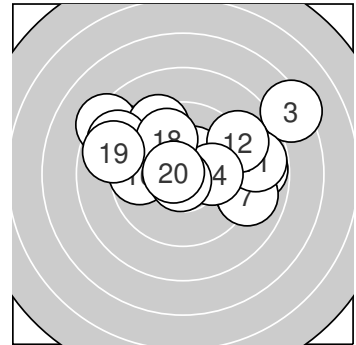

**Serie 1:**

10.2 *	9.4 →	7.3 ↗	8.8 ↖	8.8 →
9.0 →	9.0 →	9.4 ↖	8.3 ↖	10.4 *

beste Teiler: 144.4 (10.), 191.8 (1.), 376.2 (8.)  
 Trefferlage: 1.14 mm rechts, 1.30 mm hoch  
 Streuwert: 3.63, horizontal: 4.74, vertikal: 1.98

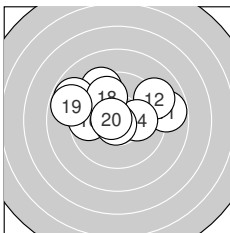

**Serie 2:**

8.8 →	9.1 ↗	9.4 ↖	10.1 →	8.8 ↖
9.7 ←	10.8 *	9.8 ↖	8.8 ↖	10.7 *

beste Teiler: 50.3 (17.), 70.6 (20.), 212.0 (14.)  
 Trefferlage: 0.53 mm links, 1.31 mm hoch  
 Streuwert: 2.64, horizontal: 3.47, vertikal: 1.37



Ergebnis: **183.3** (170)  
 Serien: 96.5 86.8  
 Zähler: 4 7 6 1 2 0 0 0 0 0  
 Innenzehner: 3  
 Weitester: 1046 (13.), 1009 (16.), 761 (14.)  
 beste Teiler: 84.4 (19.), 98.0 (12.), 138.0 (9.)  
 Trefferlage: 2.53 mm links, 1.61 mm tief  
 Streuwert: 3.05, horizontal: 3.43, vertikal: 2.62

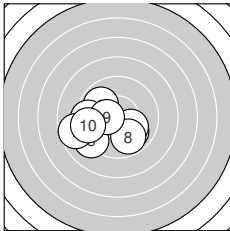
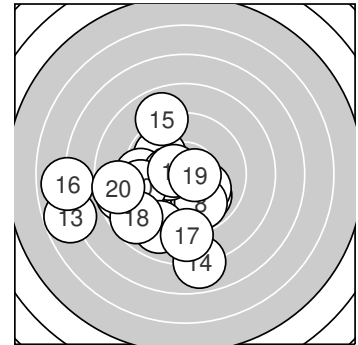

**Serie 1:**

9.9 ↘	9.9 ↘	10.1 ↘	9.7 ←	9.2 ↙
9.4 ←	8.7 ←	9.8 ↘	10.4 *	9.4 ←

beste Teiler: 138.0 (9.), 209.2 (3.), 253.1 (1.)  
 Trefferlage: 1.80 mm links, 1.06 mm tief  
 Streuwert: 2.06, horizontal: 2.58, vertikal: 1.34

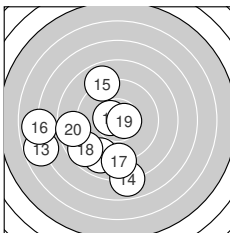

**Serie 2:**

8.9 ↙	10.6 *	6.8 ←	7.9 ↓	8.9 ↘
6.9 ←	8.9 ↓	8.7 ↙	10.6 *	8.6 ←

beste Teiler: 84.4 (19.), 98.0 (12.), 503.1 (11.)  
 Trefferlage: 3.26 mm links, 2.16 mm tief  
 Streuwert: 3.81, horizontal: 4.12, vertikal: 3.47



**Ergebnis:** **182.9** (173)  
**Serien:** 91.8 91.1  
**Zähler:** 5 7 4 4 0 0 0 0 0 0  
**Innenzehner:** 2  
**Weiteste:** 929 (7.), 844 (13.), 815 (4.)  
**beste Teiler:** 105.3 (15.), 154.1 (18.), 215.6 (5.)  
**Trefferlage:** 2.72 mm links, 1.32 mm hoch  
**Streuwert:** 2.99, horizontal: 3.88, vertikal: 1.70

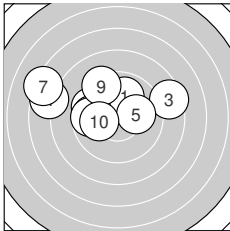
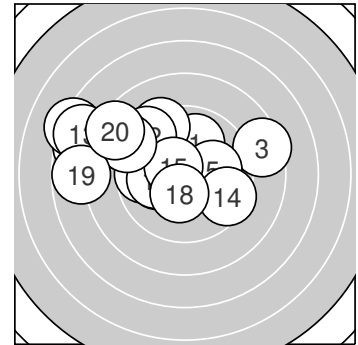

**Serie 1:**

9.9 ↗	9.6 ↖	8.4 →	7.7 ↖	10.1 →
9.8 ←	7.2 ↖	9.7 ←	9.3 ↘	10.1 ←

**beste Teiler:** 215.6 (5.), 217.1 (10.), 252.0 (1.)  
**Trefferlage:** 2.08 mm links, 1.50 mm hoch  
**Streuwert:** 3.24, horizontal: 4.33, vertikal: 1.47

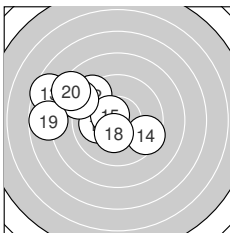

**Serie 2:**

10.0 ←	9.3 ↘	7.6 ↖	9.5 ↘	10.5 *
8.8 ↘	8.9 ↖	10.3 *	7.8 ←	8.4 ↘

**beste Teiler:** 105.3 (15.), 154.1 (18.), 226.3 (11.)  
**Trefferlage:** 3.37 mm links, 1.13 mm hoch  
**Streuwert:** 2.82, horizontal: 3.47, vertikal: 1.96



Ergebnis: **206.1** (197)  
 Serien: 104.2 101.9  
 Zähler: 18 1 1 0 0 0 0 0 0 0  
 Innenzehner: 16  
 Weitester: 622 (14.), 270 (12.), 243 (11.)  
 beste Teiler: 39.3 (20.), 45.6 (5.), 70.9 (7.)  
 Trefferlage: 0.17 mm links, 0.14 mm tief  
 Streuwert: 1.46, horizontal: 1.77, vertikal: 1.08

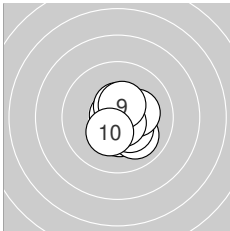
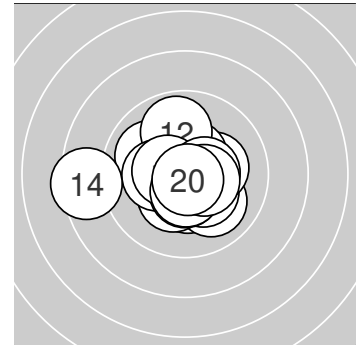

**Serie 1:**

10.4 *	10.0 ↘	10.5 *	10.3 *	10.8 *
10.2 *	10.7 *	10.5 *	10.5 *	10.3 *

beste Teiler: 45.6 (5.), 70.9 (7.), 103.0 (8.)  
 Trefferlage: 0.55 mm rechts, 0.32 mm tief  
 Streuwert: 0.95, horizontal: 0.85, vertikal: 1.05

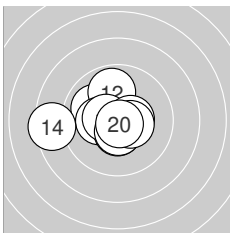

**Serie 2:**

10.0 ↙	9.9 ↑	10.3 *	8.5 ←	10.5 *
10.5 *	10.5 *	10.5 *	10.4 *	10.8 *

beste Teiler: 39.3 (20.), 107.1 (18.), 110.8 (16.)  
 Trefferlage: 0.90 mm links, 0.04 mm hoch  
 Streuwert: 1.73, horizontal: 2.17, vertikal: 1.12





**Ergebnis: 188.0** (179)  
**Serien:** 92.0 96.0  
**Zähler:** 7 6 6 1 0 0 0 0 0 0  
**Innenzehner:** 6  
**Weiteste:** 796 (9.), 730 (15.), 728 (5.)  
**beste Teiler:** 73.8 (19.), 100.9 (14.), 118.2 (7.)  
**Trefferlage:** 1.63 mm rechts, 0.25 mm tief  
**Streuwert:** 3.06, horizontal: 3.85, vertikal: 1.97

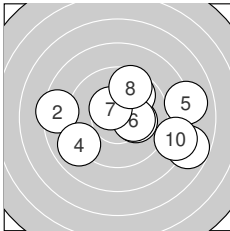
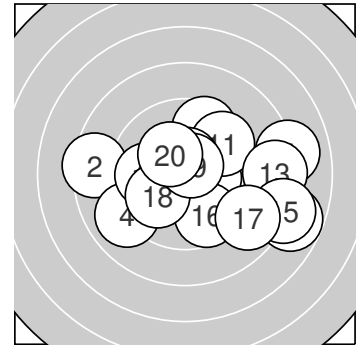

**Serie 1:**

10.2 *	8.4 ←	9.8 ↗	9.0 ↙	8.0 →
10.3 *	10.5 *	9.6 ↗	7.8 ↘	8.4 →

**beste Teiler:** 118.2 (7.), 170.0 (6.), 195.3 (1.)  
**Trefferlage:** 1.61 mm rechts, 0.03 mm tief  
**Streuwert:** 3.53, horizontal: 4.51, vertikal: 2.15

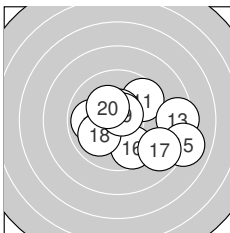

**Serie 2:**

9.6 ↗	9.9 ←	8.4 →	10.6 *	8.0 →
9.7 ↘	8.8 ↘	10.0 ↙	10.7 *	10.3 *

**beste Teiler:** 73.8 (19.), 100.9 (14.), 172.2 (20.)  
**Trefferlage:** 1.65 mm rechts, 0.48 mm tief  
**Streuwert:** 2.68, horizontal: 3.30, vertikal: 1.87



Ergebnis: **202.4** (194)  
 Serien: 102.3 100.1  
 Zähler: 14 6 0 0 0 0 0 0 0 0  
 Innenzehner: 8  
 Weitestе: 400 (17.), 317 (3.), 305 (14.)  
 beste Teiler: 34.0 (8.), 39.0 (1.), 73.3 (11.)  
 Trefferlage: 1.57 mm links, 0.37 mm tief  
 Streuwert: 1.13, horizontal: 1.20, vertikal: 1.04

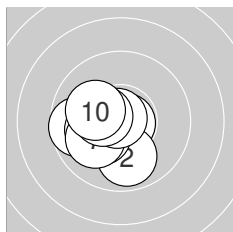
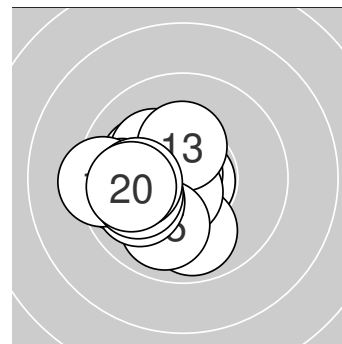

**Serie 1:**

10.8 *	9.9 ↓	9.7 ←	10.2 *	10.3 *
10.1 ←	10.0 ↙	10.8 *	10.4 *	10.1 ↘

beste Teiler: 34.0 (8.), 39.0 (1.), 138.0 (9.)  
 Trefferlage: 1.26 mm links, 0.42 mm tief  
 Streuwert: 1.08, horizontal: 1.13, vertikal: 1.02

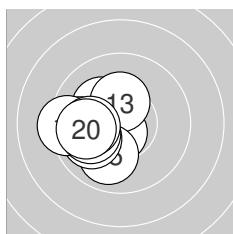

**Serie 2:**

10.7 *	10.2 *	10.3 *	9.7 ←	9.9 ↓
10.0 ←	9.4 ←	10.0 ←	10.0 ←	9.9 ←

beste Teiler: 73.3 (11.), 159.0 (13.), 187.9 (12.)  
 Trefferlage: 1.89 mm links, 0.32 mm tief  
 Streuwert: 1.18, horizontal: 1.24, vertikal: 1.12



**LG 20 ZR** – Wertung –  
StandNr: 118  
**Geisler,, Lorenz** #70804124

**Jugend\_I\_männl.**

**StartNr: 11**  
2. Oktober 2021 10:06  
SG\_Fügenberg

Ergebnis: **0.0** (0)<sub>DNS</sub>  
Serien:  
Zähler: 0 0 0 0 0 0 0 0 0 0  
Innenzehner: 0  
Weiteste:  
~~beste Teiler~~  
Trefferlage: 0.00 mm , 0.00 mm  
Streuwert:

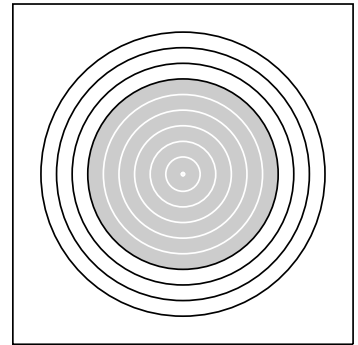

Ergebnis: **200.7** (191)  
 Serien: 99.0 101.7  
 Zähler: 11 9 0 0 0 0 0 0 0 0  
 Innenzehner: 9  
 Weitesten: 496 (6.), 405 (2.), 352 (1.)  
 beste Teiler: 70.4 (4.), 93.1 (18.), 106.6 (7.)  
 Trefferlage: 0.27 mm rechts, 0.40 mm hoch  
 Streuwert: 1.83, horizontal: 2.10, vertikal: 1.50

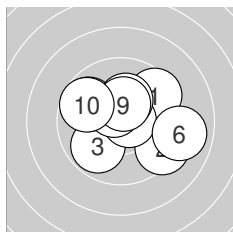
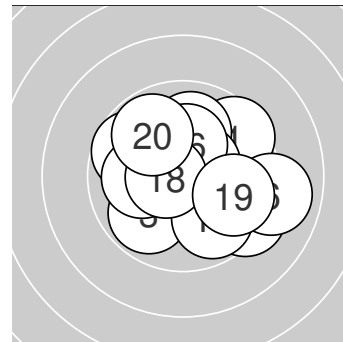

**Serie 1:**

9.5 ↗	9.3 ↘	9.9 ↙	10.7 *	9.8 ↖
9.0 →	10.5 *	10.2 *	10.4 *	9.7 ↗

beste Teiler: 70.4 (4.), 106.6 (7.), 143.8 (9.)  
 Trefferlage: 0.46 mm rechts, 0.38 mm hoch  
 Streuwert: 2.15, horizontal: 2.59, vertikal: 1.58

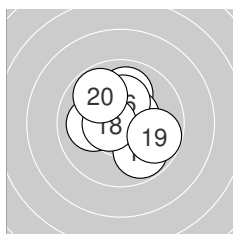

**Serie 2:**

10.5 *	10.3 *	10.0 ↑	10.5 *	10.1 ←
10.3 *	9.8 ↘	10.6 *	9.8 →	9.8 ↖

beste Teiler: 93.1 (18.), 111.2 (14.), 114.5 (11.)  
 Trefferlage: 0.08 mm rechts, 0.42 mm hoch  
 Streuwert: 1.55, horizontal: 1.60, vertikal: 1.50



Ergebnis: **188.3** (179)  
 Serien: 93.2 95.1  
 Zähler: 6 9 3 2 0 0 0 0 0 0  
 Innenzehner: 5  
 Weitestе: 916 (16.), 890 (1.), 623 (15.)  
 beste Teiler: 56.2 (20.), 82.2 (13.), 91.2 (7.)  
 Trefferlage: 0.30 mm links, 1.12 mm tief  
 Streuwert: 3.18, horizontal: 2.18, vertikal: 3.93

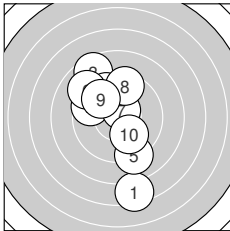
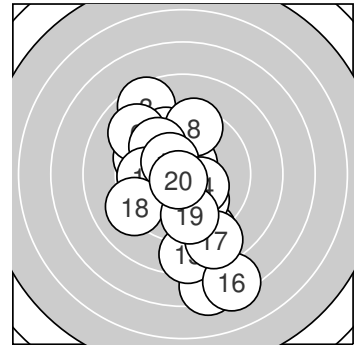

**Serie 1:**

7.4 ↓	9.6 ↖	8.6 ↗	9.7 ↗	9.0 ↓
9.0 ↘	10.6 *	9.5 ↑	9.8 ↘	10.0 ↓

beste Teiler: 91.2 (7.), 239.9 (10.), 289.5 (9.)  
 Trefferlage: 0.63 mm links, 0.42 mm hoch  
 Streuwert: 3.38, horizontal: 2.17, vertikal: 4.26

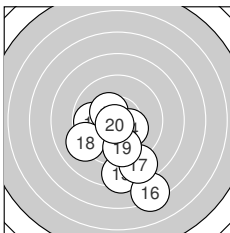

**Serie 2:**

9.8 ←	10.4 *	10.6 *	10.3 *	8.5 ↓
7.3 ↓	8.7 ↓	9.1 ↙	9.7 ↓	10.7 *

beste Teiler: 56.2 (20.), 82.2 (13.), 139.3 (12.)  
 Trefferlage: 0.03 mm rechts, 2.67 mm tief  
 Streuwert: 2.66, horizontal: 2.25, vertikal: 3.02



**Ergebnis:** **184.5** (175)  
**Serien:** 92.3 92.2  
**Zähler:** 7 5 4 4 0 0 0 0 0 0  
**Innenzehner:** 7  
**Weiteste:** 882 (2.), 855 (9.), 848 (18.)  
**beste Teiler:** 38.4 (3.), 75.2 (1.), 75.2 (5.)  
**Trefferlage:** 0.75 mm rechts, 1.00 mm tief  
**Streuwert:** 3.62, horizontal: 4.88, vertikal: 1.56

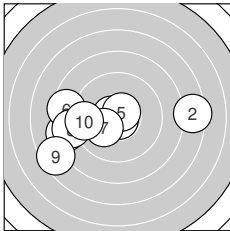
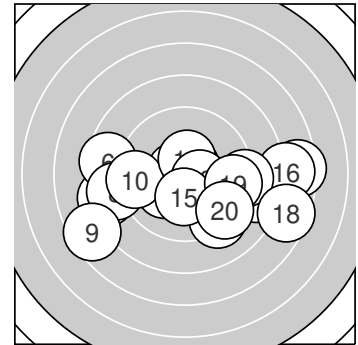

**Serie 1:**

10.7 *	7.4 →	10.8 *	8.4 ←	10.7 *
8.5 ←	10.2 *	8.7 ←	7.5 ←	9.4 ←

**beste Teiler:** 38.4 (3.), 75.2 (1.), 75.2 (5.)  
**Trefferlage:** 2.17 mm links, 0.73 mm tief  
**Streuwert:** 3.57, horizontal: 4.78, vertikal: 1.62

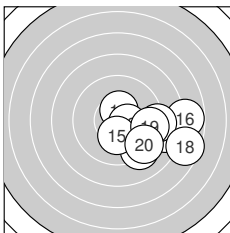

**Serie 2:**

9.2 ↘	10.5 *	10.5 *	8.6 →	10.2 *
7.8 →	9.1 →	7.6 →	9.4 →	9.3 ↘

**beste Teiler:** 120.0 (12.), 121.4 (13.), 178.2 (15.)  
**Trefferlage:** 3.67 mm rechts, 1.27 mm tief  
**Streuwert:** 2.31, horizontal: 2.89, vertikal: 1.54



Ergebnis: **184.8** (175)  
 Serien: 95.6 89.2  
 Zähler: 4 9 5 2 0 0 0 0 0 0  
 Innenzehner: 2  
 Weitester: 939 (19.), 913 (17.), 643 (12.)  
 beste Teiler: 68.5 (10.), 188.3 (7.), 208.7 (18.)  
 Trefferlage: 0.41 mm rechts, 0.04 mm tief  
 Streuwert: 3.49, horizontal: 4.69, vertikal: 1.52

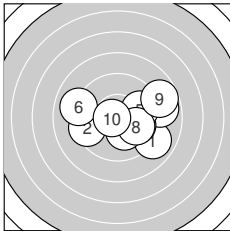
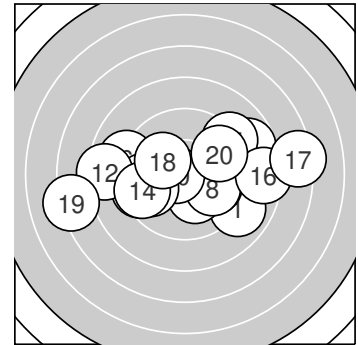

**Serie 1:**

8.9 ↘	9.4 ←	8.9 →	9.9 ↘	9.8 →
9.0 ↖	10.2 *	10.0 ↘	8.8 →	10.7 *

beste Teiler: 68.5 (10.), 188.3 (7.), 245.9 (8.)  
 Trefferlage: 1.33 mm rechts, 0.23 mm tief  
 Streuwert: 2.65, horizontal: 3.41, vertikal: 1.56

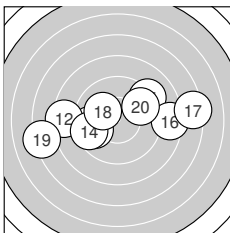

**Serie 2:**

9.6 ←	8.4 ←	9.8 ←	9.5 ←	9.2 ↗
8.4 →	7.3 →	10.1 ↘	7.2 ←	9.7 ↗

beste Teiler: 208.7 (18.), 299.0 (13.), 320.7 (20.)  
 Trefferlage: 0.50 mm links, 0.14 mm hoch  
 Streuwert: 4.20, horizontal: 5.74, vertikal: 1.53

