

Ergebnis: **185.2** (176)
 Serien: 95.3 89.9
 Zähler: 6 7 4 3 0 0 0 0 0 0
 Innenzehner: 5
 weiteste: 949 (18), 801 (8), 766 (14)
 beste Teiler 84.6 (10.) 151.4 (2.) 175.4 (3.)
 Trefferlage 1.04 mm links, 0.08 mm hoch
 Streuwert 3.44, horizontal: 4.31, vertikal: 2.26

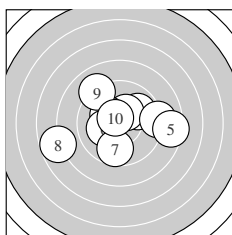

Serie 1:
 9.9 ↗ 10.3 * 10.3 * 9.1 → 8.4 →
 10.2 * 9.7 ↓ 7.7 ← 9.1 ↖ 10.6 *
 beste Teiler 84.6 (10.) 151.4 (2.) 175.4 (3.)
 Trefferlage 0.07 mm links, 0.17 mm hoch
 Streuwert 3.13, horizontal: 3.93, vertikal: 2.03

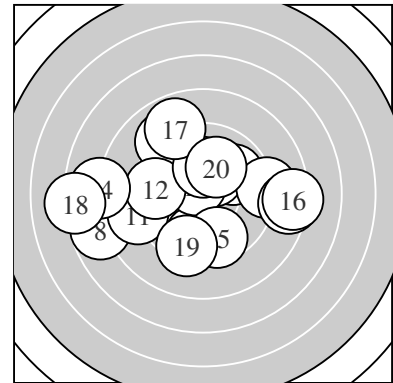
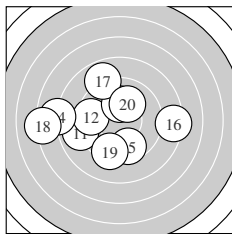

Serie 2:
 8.9 ← 9.5 ← 10.2 * 7.9 ← 9.6 ↓
 8.3 → 8.9 ↖ 7.2 ← 9.3 ↓ 10.1 ↗
 beste Teiler 197.0 (13.) 220.0 (20.) 338.3 (15.)
 Trefferlage 2.01 mm links, 0.00 mm
 Streuwert 3.76, horizontal: 4.66, vertikal: 2.57

Unterschrift des Schützen

Ergebnis: **205.2** (197)
 Serien: 104.4 100.8
 Zähler: 17 3 0 0 0 0 0 0 0 0
 Innenzehner: 15
 weiteste: 452 (16), 449 (12), 266 (11)
 beste Teiler 56.7 (15.) 71.0 (10.) 86.0 (7.)
 Trefferlage 0.54 mm links, 0.12 mm hoch
 Streuwert 1.42, horizontal: 1.90, vertikal: 0.66

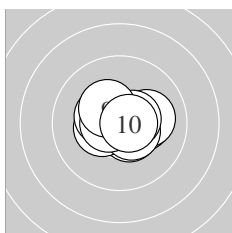
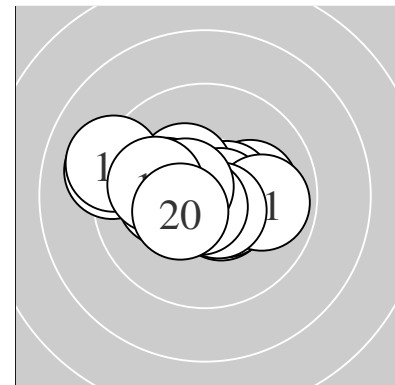

Serie 1:
 10.5 * 10.3 * 10.1 → 10.4 * 10.4 *
 10.5 * 10.6 * 10.5 * 10.4 * 10.7 *
 beste Teiler 71.0 (10.) 86.0 (7.) 104.0 (8.)
 Trefferlage 0.27 mm rechts, 0.06 mm hoch
 Streuwert 0.99, horizontal: 1.28, vertikal: 0.57

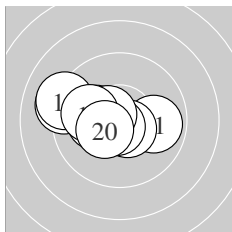

Serie 2:
 9.9 → 9.2 ← 10.2 * 10.6 * 10.7 *
 9.1 ← 10.2 * 10.5 * 10.0 ← 10.4 *
 beste Teiler 56.7 (15.) 91.9 (14.) 101.0 (18.)
 Trefferlage 1.36 mm links, 0.17 mm hoch
 Streuwert 1.59, horizontal: 2.11, vertikal: 0.77

Unterschrift des Schützen

Ergebnis: **183.9** (175)
 Serien: 92.7 91.2
 Zähler: 7 7 4 1 0 0 0 1 0 0
 Innenzehner: 6
 weiteste: 1977 (18), 791 (20), 700 (19)
 beste Teiler 64.0 (11.) 78.4 (6.) 94.8 (12.)
 Trefferlage 1.60 mm rechts, 0.90 mm tief
 Streuwert 4.18, horizontal: 5.58, vertikal: 1.98

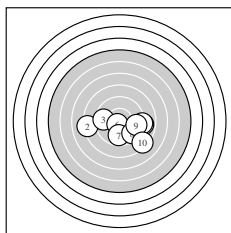
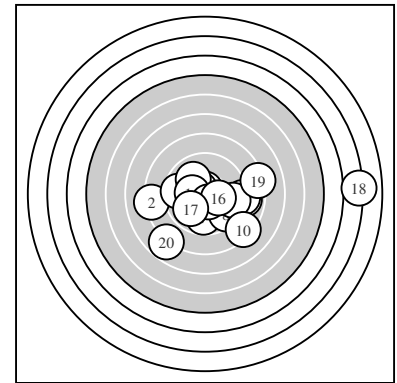

Serie 1:
 9.3 → 8.2 ← 9.6 ← 8.9 → 9.0 →
 10.6 * 9.8 ↓ 9.5 ↘ 9.5 → 8.3 ↘
 beste Teiler 78.4 (6.) 299.6 (7.) 346.7 (3.)
 Trefferlage 1.40 mm rechts, 1.42 mm tief
 Streuwert 3.06, horizontal: 4.07, vertikal: 1.48

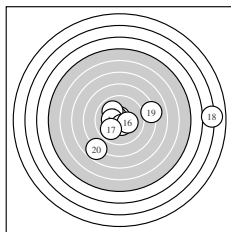

Serie 2:
 10.7 * 10.6 * 10.0 ↖ 10.3 * 10.5 *
 10.2 * 9.9 ↙ 3.0 → 8.2 → 7.8 ↙
 beste Teiler 64.0 (11.) 94.8 (12.) 110.6 (15.)
 Trefferlage 1.79 mm rechts, 0.38 mm tief
 Streuwert 5.22, horizontal: 7.00, vertikal: 2.34

Unterschrift des Schützen

Ergebnis: **194.5** (186)
 Serien: 95.8 98.7
 Zähler: 9 8 3 0 0 0 0 0 0 0
 Innenzehner: 6
 weiteste: 713 (5), 699 (11), 539 (6)
 beste Teiler 46.1 (12.) 66.0 (19.) 78.0 (4.)
 Trefferlage 0.26 mm links, 0.55 mm tief
 Streuwert 2.56, horizontal: 2.72, vertikal: 2.40

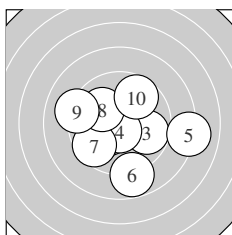
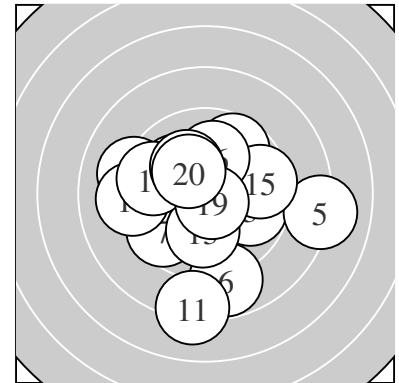

Serie 1:
 10.3 * 9.7 ↙ 9.8 → 10.6 * 8.1 →
 8.8 ↓ 9.6 ↙ 10.1 ↖ 9.1 ← 9.7 ↗
 beste Teiler 78.0 (4.) 151.3 (1.) 225.0 (8.)
 Trefferlage 0.05 mm rechts, 0.79 mm tief
 Streuwert 2.81, horizontal: 3.29, vertikal: 2.22

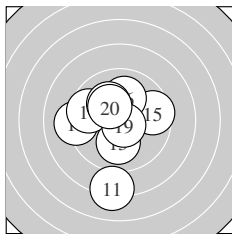

Serie 2:
 8.2 ↓ 10.8 * 10.1 ↓ 9.2 ← 9.6 →
 10.0 ↑ 9.6 ← 10.2 * 10.7 * 10.3 *
 beste Teiler 46.1 (12.) 66.0 (19.) 170.4 (20.)
 Trefferlage 0.59 mm links, 0.32 mm tief
 Streuwert 2.41, horizontal: 2.13, vertikal: 2.66

Unterschrift des Schützen

Ergebnis: **189.5** (179)
 Serien: 96.1 93.4
 Zähler: 3 15 1 0 1 0 0 0 0 0
 Innenzehner: 3
 weiteste: 1002 (16), 673 (2), 454 (19)
 beste Teiler 83.0 (3.) 99.7 (15.) 135.0 (20.)
 Trefferlage 0.54 mm links, 0.54 mm tief
 Streuwert 2.98, horizontal: 3.84, vertikal: 1.72

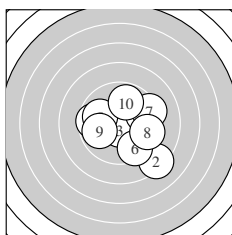
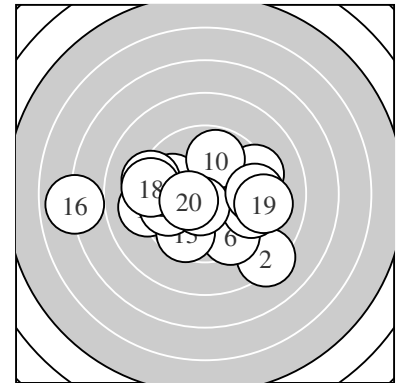

Serie 1:
 9.6 ← 8.3 ↘ 10.6 * 9.7 → 9.9 ←
 9.5 ↘ 9.3 → 9.5 → 9.9 ← 9.8 ↑
 beste Teiler 83.0 (3.) 263.4 (5.) 274.4 (9.)
 Trefferlage 0.93 mm rechts, 0.46 mm tief
 Streuwert 2.62, horizontal: 2.94, vertikal: 2.26

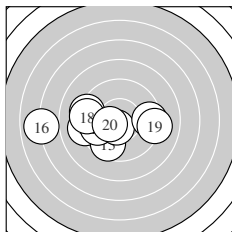

Serie 2:
 9.1 ← 9.2 ← 9.6 ↙ 9.8 ← 10.6 *
 6.9 ← 9.4 → 9.3 ← 9.1 → 10.4 *
 beste Teiler 99.7 (15.) 135.0 (20.) 296.9 (14.)
 Trefferlage 2.03 mm links, 0.63 mm tief
 Streuwert 3.07, horizontal: 4.20, vertikal: 1.08

Unterschrift des Schützen

Ergebnis: **174.6** (166)
 Serien: 88.6 86.0
 Zähler: 3 5 8 3 1 0 0 0 0 0
 Innenzehner: 2
 weiteste: 1163 (19), 999 (10), 948 (13)
 beste Teiler 105.3 (7.) 171.8 (20.) 248.3 (16.)
 Trefferlage 2.46 mm rechts, 2.93 mm hoch
 Streuwert 3.52, horizontal: 4.61, vertikal: 1.89

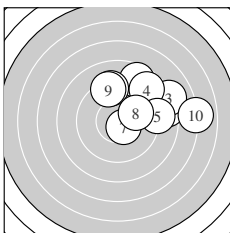
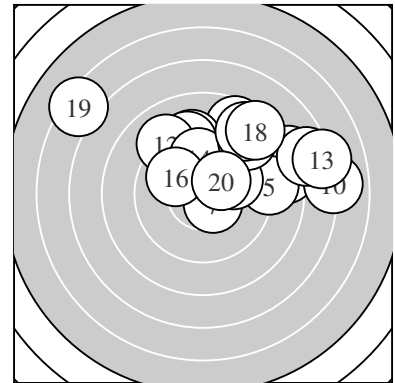

Serie 1:

8.3 → 8.6 ↗ 8.1 ↗ 8.8 ↗ 8.9 →
 9.2 ↑ 10.5 * 9.9 ↗ 9.3 ↑ 7.0 →

beste Teiler 105.3 (7.) 256.3 (8.) 423.3 (9.)
 Trefferlage 3.51 mm rechts, 2.38 mm hoch
 Streuwert 2.87, horizontal: 3.54, vertikal: 1.98

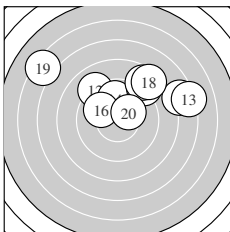

Serie 2:

7.6 → 9.0 ↘ 7.2 → 9.8 ↑ 8.8 ↗
 10.0 ↘ 8.6 ↗ 8.4 ↗ 6.3 ↘ 10.3 *

beste Teiler 171.8 (20.) 248.3 (16.) 281.0 (14.)
 Trefferlage 1.41 mm rechts, 3.49 mm hoch
 Streuwert 4.05, horizontal: 5.46, vertikal: 1.72

Unterschrift des Schützen

Ergebnis: **191.5** (179)
 Serien: 93.9 97.6
 Zähler: 5 10 4 1 0 0 0 0 0 0
 Innenzehner: 4
 weiteste: 757 (4), 742 (1), 588 (3)
 beste Teiler 27.0 (13.) 83.4 (9.) 127.4 (2.)
 Trefferlage 0.98 mm rechts, 0.32 mm hoch
 Streuwert 2.76, horizontal: 3.56, vertikal: 1.60

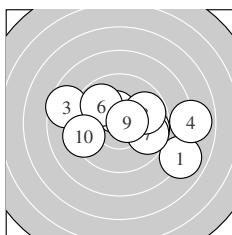
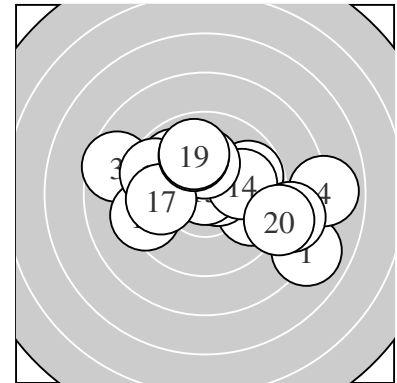

Serie 1:
 8.0 ↘ 10.4 * 8.6 ↖ 7.9 → 9.7 →
 9.9 ↙ 9.7 → 9.8 → 10.6 * 9.3 ←
 beste Teiler 83.4 (9.) 127.4 (2.) 272.9 (6.)
 Trefferlage 1.18 mm rechts, 0.02 mm tief
 Streuwert 3.23, horizontal: 4.24, vertikal: 1.69

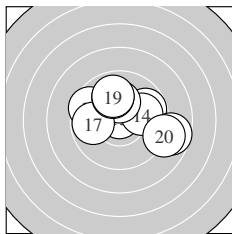

Serie 2:
 9.6 ↖ 9.8 → 10.8 * 10.0 → 10.2 *
 8.7 → 9.8 ← 9.9 ↑ 9.9 ↑ 8.9 →
 beste Teiler 27.0 (13.) 195.0 (15.) 244.2 (14.)
 Trefferlage 0.78 mm rechts, 0.67 mm hoch
 Streuwert 2.34, horizontal: 2.95, vertikal: 1.50

Unterschrift des Schützen

Ergebnis: **201.2** (194)
 Serien: 99.4 101.8
 Zähler: 14 6 0 0 0 0 0 0 0 0
 Innenzehner: 8
 weiteste: 431 (9), 318 (15), 318 (20)
 beste Teiler 102.8 (18.) 109.5 (2.) 144.3 (14.)
 Trefferlage 0.26 mm links, 0.03 mm hoch
 Streuwert 1.70, horizontal: 1.89, vertikal: 1.49

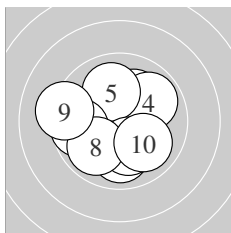
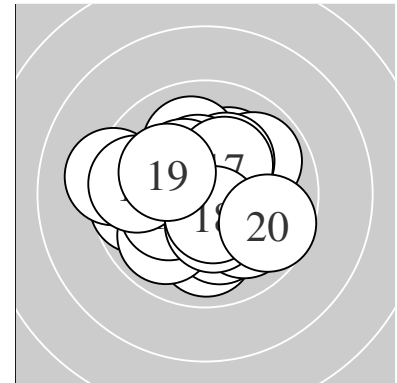

Serie 1:
 10.1 ↗ 10.5 * 10.0 ↓ 9.9 ↗ 10.0 ↑
 10.1 ↓ 9.7 ← 9.9 ↖ 9.2 ← 10.0 ↘
 beste Teiler 109.5 (2.) 204.2 (6.) 207.0 (1.)
 Trefferlage 0.29 mm links, 0.17 mm tief
 Streuwert 1.96, horizontal: 2.14, vertikal: 1.75

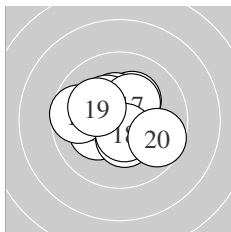

Serie 2:
 10.2 * 10.2 * 10.4 * 10.4 * 9.7 ←
 10.3 * 10.3 * 10.5 * 10.1 ↖ 9.7 →
 beste Teiler 102.8 (18.) 144.3 (14.) 145.0 (13.)
 Trefferlage 0.24 mm links, 0.24 mm hoch
 Streuwert 1.49, horizontal: 1.72, vertikal: 1.22

Unterschrift des Schützen

Ergebnis: **188.9** (178)
 Serien: 93.2 95.7
 Zähler: 5 9 5 1 0 0 0 0 0 0
 Innenzehner: 4
 weiteste: 785 (2), 669 (7), 620 (5)
 beste Teiler 92.3 (20.) 94.0 (18.) 110.5 (1.)
 Trefferlage 1.17 mm rechts, 0.22 mm hoch
 Streuwert 2.95, horizontal: 3.79, vertikal: 1.76

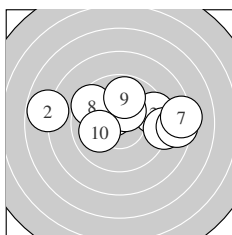
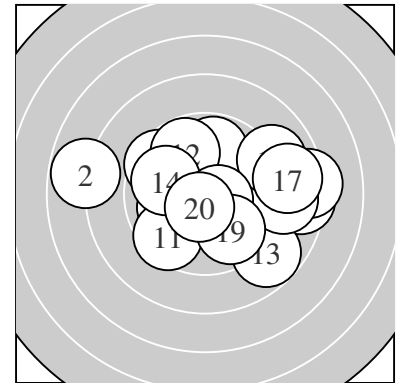

Serie 1:
 10.5 * 7.8 ← 9.4 → 9.0 → 8.5 →
 10.4 * 8.3 → 9.5 ↖ 9.8 ↑ 10.0 ←
 beste Teiler 110.5 (1.) 147.6 (6.) 232.8 (10.)
 Trefferlage 0.88 mm rechts, 0.81 mm hoch
 Streuwert 3.32, horizontal: 4.55, vertikal: 1.14

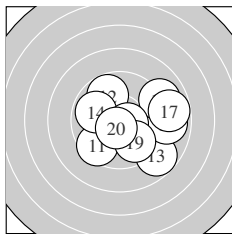

Serie 2:
 9.5 ↙ 9.8 ↖ 8.8 ↘ 9.9 ↖ 8.9 →
 9.0 → 8.8 → 10.6 * 9.8 ↘ 10.6 *
 beste Teiler 92.3 (20.) 94.0 (18.) 268.4 (14.)
 Trefferlage 1.45 mm rechts, 0.35 mm tief
 Streuwert 2.64, horizontal: 3.07, vertikal: 2.12

Unterschrift des Schützen

Ergebnis: **176.0** (170)
 Serien: 90.9 85.1
 Zähler: 3 8 6 2 1 0 0 0 0 0
 Innenzehner: 0
 weiteste: 1185 (16), 861 (5), 784 (19)
 beste Teiler 222.7 (10.) 235.0 (1.) 248.1 (7.)
 Trefferlage 0.60 mm links, 0.57 mm hoch
 Streuwert 4.18, horizontal: 5.36, vertikal: 2.51

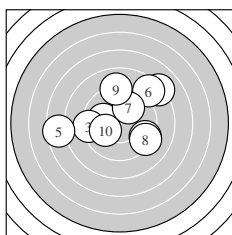
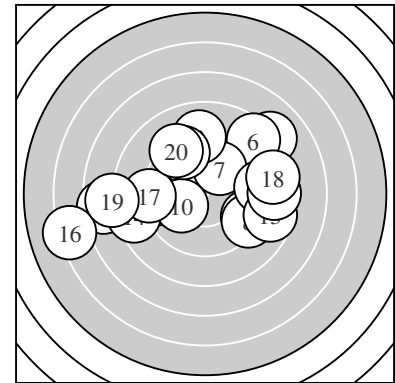

Serie 1:
 10.0 ↖ 8.1 ↗ 9.2 ← 9.3 ↘ 7.5 ←
 8.5 ↗ 10.0 ↗ 9.2 ↘ 9.0 ↑ 10.1 ←
 beste Teiler 222.7 (10.) 235.0 (1.) 248.1 (7.)
 Trefferlage 0.03 mm rechts, 0.99 mm hoch
 Streuwert 3.70, horizontal: 4.41, vertikal: 2.82

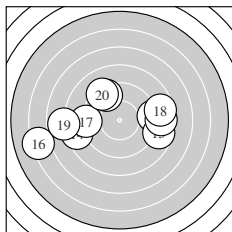

Serie 2:
 9.4 ↖ 9.1 → 8.6 ↘ 8.5 ← 8.6 →
 6.2 ← 9.1 ← 8.6 → 7.8 ← 9.2 ↖
 beste Teiler 394.1 (11.) 437.6 (20.) 471.2 (17.)
 Trefferlage 1.24 mm links, 0.15 mm hoch
 Streuwert 4.75, horizontal: 6.34, vertikal: 2.23

Unterschrift des Schützen

Ergebnis: **168.3** (158)
 Serien: 81.3 87.0
 Zähler: 2 5 7 3 1 2 0 0 0 0
 Innenzehner: 2
 weiteste: 1353 (3), 1293 (12), 1123 (5)
 beste Teiler 162.6 (14.) 199.5 (2.) 311.8 (20.)
 Trefferlage 0.14 mm rechts, 1.21 mm tief
 Streuwert 5.07, horizontal: 6.69, vertikal: 2.61

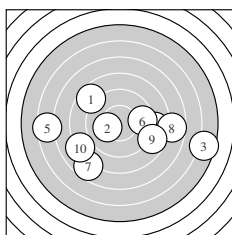
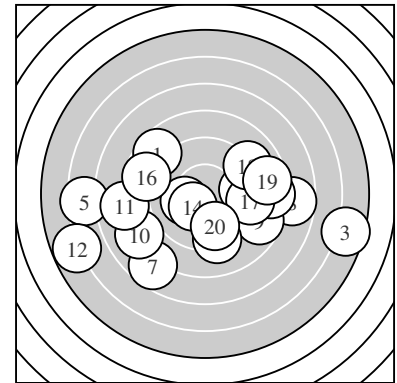

Serie 1:
 8.6 ↘ 10.2 * 5.5 → 8.8 → 6.5 ←
 9.5 → 7.7 ↙ 7.7 → 8.7 → 8.1 ←
 beste Teiler 199.5 (2.) 357.5 (6.) 548.7 (4.)
 Trefferlage 0.67 mm rechts, 1.46 mm tief
 Streuwert 5.68, horizontal: 7.53, vertikal: 2.81

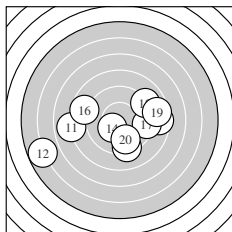

Serie 2:
 7.9 ← 5.8 ← 8.5 → 10.3 * 9.2 ↓
 8.7 ← 9.3 → 9.0 ↗ 8.6 → 9.7 ↓
 beste Teiler 162.6 (14.) 311.8 (20.) 425.2 (17.)
 Trefferlage 0.38 mm links, 0.95 mm tief
 Streuwert 4.66, horizontal: 6.09, vertikal: 2.51

Unterschrift des Schützen

Ergebnis: **195.6** (185)
 Serien: 99.2 96.4
 Zähler: 7 11 2 0 0 0 0 0 0 0
 Innenzehner: 6
 weiteste: 547 (19), 512 (11), 420 (10)
 beste Teiler 67.8 (16.) 116.1 (7.) 127.1 (12.)
 Trefferlage 0.36 mm links, 0.21 mm hoch
 Streuwert 2.32, horizontal: 2.99, vertikal: 1.35

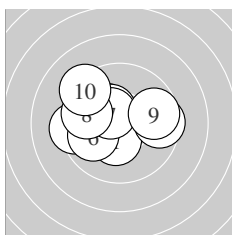
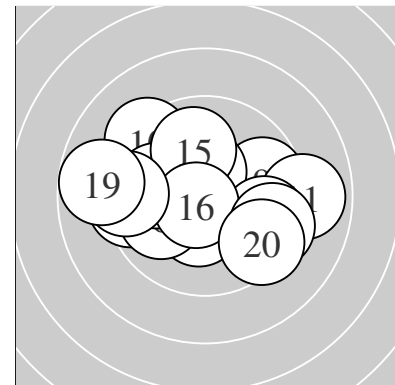

Serie 1:
 10.4 * 9.6 → 9.4 ← 10.2 * 10.4 *
 9.9 ← 10.5 * 9.8 ← 9.7 → 9.3 ↘
 beste Teiler 116.1 (7.) 140.9 (5.) 149.6 (1.)
 Trefferlage 0.88 mm links, 0.49 mm hoch
 Streuwert 1.96, horizontal: 2.46, vertikal: 1.27

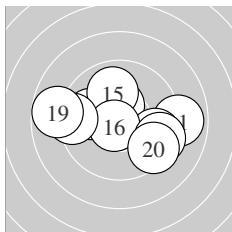

Serie 2:
 8.9 → 10.4 * 9.9 ← 9.6 → 10.0 ↑
 10.7 * 9.3 ← 9.4 → 8.8 ← 9.4 ↘
 beste Teiler 67.8 (16.) 127.1 (12.) 249.5 (15.)
 Trefferlage 0.14 mm rechts, 0.06 mm tief
 Streuwert 2.67, horizontal: 3.50, vertikal: 1.43

Unterschrift des Schützen

Ergebnis: **207.6** (199)
 Serien: 104.0 103.6
 Zähler: 19 1 0 0 0 0 0 0 0 0
 Innenzehner: 16
 weiteste: 271 (17), 246 (15), 225 (2)
 beste Teiler 15.5 (3.) 27.5 (4.) 70.3 (18.)
 Trefferlage 0.34 mm rechts, 0.30 mm hoch
 Streuwert 1.10, horizontal: 1.37, vertikal: 0.74

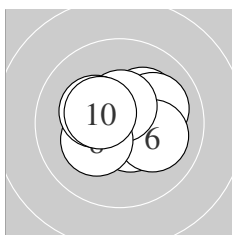
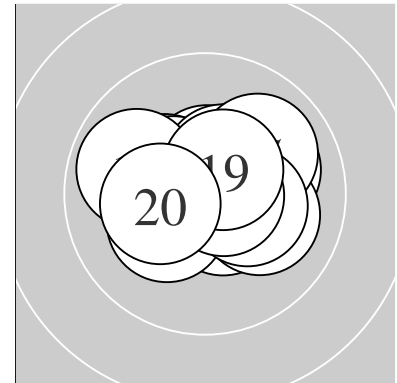

Serie 1:
 10.2 * 10.1 ↗ 10.9 * 10.8 * 10.5 *
 10.1 ↘ 10.5 * 10.2 * 10.3 * 10.4 *
 beste Teiler 15.5 (3.) 27.5 (4.) 103.5 (5.)
 Trefferlage 0.21 mm rechts, 0.22 mm hoch
 Streuwert 1.12, horizontal: 1.35, vertikal: 0.83

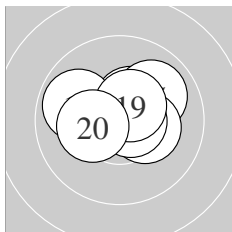

Serie 2:
 10.4 * 10.6 * 10.5 * 10.4 * 10.0 ↗
 10.3 * 9.9 ↖ 10.7 * 10.5 * 10.3 *
 beste Teiler 70.3 (18.) 89.0 (12.) 112.2 (19.)
 Trefferlage 0.48 mm rechts, 0.39 mm hoch
 Streuwert 1.12, horizontal: 1.45, vertikal: 0.66

Unterschrift des Schützen

Ergebnis: **194.4** (186)
 Serien: 96.5 97.9
 Zähler: 9 8 3 0 0 0 0 0 0 0
 Innenzehner: 7
 weiteste: 735 (6), 553 (11), 511 (15)
 beste Teiler 87.9 (8.) 132.8 (18.) 135.2 (17.)
 Trefferlage 0.98 mm rechts, 0.29 mm hoch
 Streuwert 2.43, horizontal: 3.22, vertikal: 1.22

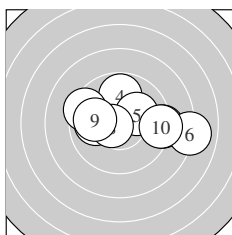
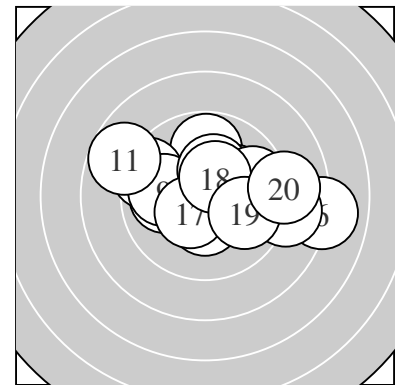

Serie 1:
 10.0 ← 9.2 → 10.3 * 9.8 ↑ 10.1 ↗
 8.0 → 9.4 ↖ 10.6 * 9.9 ← 9.2 →
 beste Teiler 87.9 (8.) 159.9 (3.) 202.2 (5.)
 Trefferlage 0.72 mm rechts, 0.45 mm hoch
 Streuwert 2.67, horizontal: 3.60, vertikal: 1.15

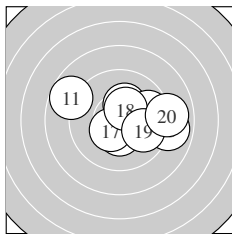

Serie 2:
 8.7 ↖ 10.2 * 10.4 * 10.3 * 8.9 →
 9.7 → 10.4 * 10.4 * 9.9 → 9.0 →
 beste Teiler 132.8 (18.) 135.2 (17.) 148.0 (13.)
 Trefferlage 1.24 mm rechts, 0.12 mm hoch
 Streuwert 2.30, horizontal: 2.96, vertikal: 1.33

Unterschrift des Schützen

Ergebnis: **169.6** (162)
 Serien: 90.0 79.6
 Zähler: 4 7 4 1 2 0 2 0 0 0
 Innenzehner: 3
 weiteste: 1565 (19), 1520 (3), 1226 (20)
 beste Teiler 160.9 (1.) 182.2 (5.) 190.5 (6.)
 Trefferlage 1.97 mm links, 0.32 mm hoch
 Streuwert 5.26, horizontal: 7.34, vertikal: 1.21

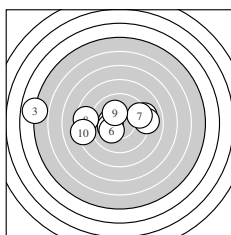
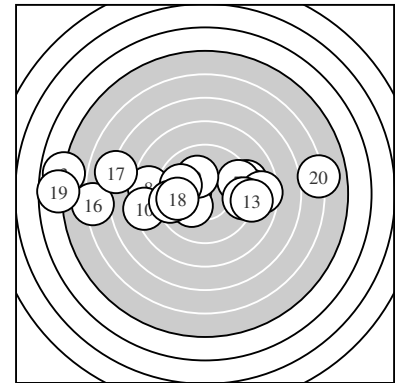

Serie 1:
 10.3 * 9.1 → 4.9 ← 9.0 → 10.2 *
 10.2 * 9.4 → 8.5 ← 10.1 ↖ 8.3 ←
 beste Teiler 160.9 (1.) 182.2 (5.) 190.5 (6.)
 Trefferlage 2.03 mm links, 0.46 mm hoch
 Streuwert 4.36, horizontal: 6.02, vertikal: 1.29

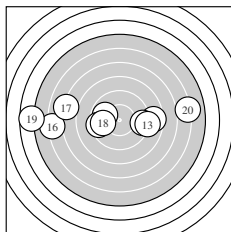

Serie 2:
 8.5 → 9.3 → 8.9 → 9.9 ← 9.4 ←
 6.1 ← 7.0 ← 9.8 ← 4.7 ← 6.0 →
 beste Teiler 275.1 (14.) 299.3 (18.) 382.1 (15.)
 Trefferlage 1.91 mm links, 0.19 mm hoch
 Streuwert 6.27, horizontal: 8.79, vertikal: 1.17

Unterschrift des Schützen

Ergebnis: **197.5** (188)
 Serien: 96.9 100.6
 Zähler: 9 10 1 0 0 0 0 0 0 0
 Innenzehner: 6
 weiteste: 691 (2), 396 (12), 371 (9)
 beste Teiler 42.3 (8.) 43.3 (17.) 127.4 (10.)
 Trefferlage 1.02 mm rechts, 0.30 mm tief
 Streuwert 2.07, horizontal: 2.56, vertikal: 1.44

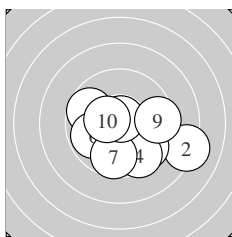
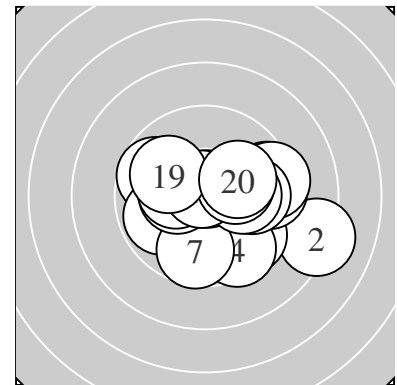

Serie 1:
 9.7 ↘ 8.2 → 9.6 ↘ 9.5 ↘ 9.7 ↖
 9.8 ← 9.7 ↓ 10.8 * 9.5 → 10.4 *
 beste Teiler 42.3 (8.) 127.4 (10.) 276.0 (6.)
 Trefferlage 1.01 mm rechts, 1.15 mm tief
 Streuwert 2.37, horizontal: 2.95, vertikal: 1.60

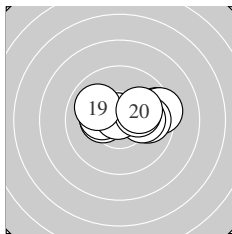

Serie 2:
 9.5 → 9.4 → 9.9 → 10.3 * 10.1 →
 10.3 * 10.8 * 10.2 * 10.0 ↖ 10.1 →
 beste Teiler 43.3 (17.) 161.0 (14.) 172.5 (16.)
 Trefferlage 1.04 mm rechts, 0.54 mm hoch
 Streuwert 1.63, horizontal: 2.26, vertikal: 0.44

Unterschrift des Schützen

Ergebnis: **183.0** (174)
 Serien: 87.4 95.6
 Zähler: 7 7 3 1 1 0 1 0 0 0
 Innenzehner: 6
 weiteste: 1553 (1), 1209 (4), 781 (8)
 beste Teiler 55.4 (10.) 71.6 (9.) 79.0 (2.)
 Trefferlage 2.49 mm links, 0.05 mm tief
 Streuwert 3.85, horizontal: 5.07, vertikal: 1.98

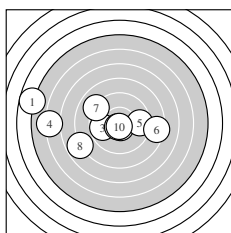
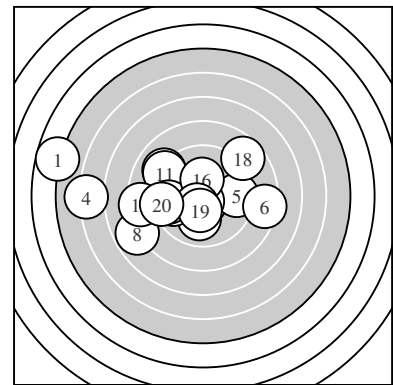

Serie 1:
 4.7 ← 10.6 * 9.8 ← 6.1 ← 9.6 →
 8.4 → 9.0 ↘ 7.8 ↙ 10.7 * 10.7 *
 beste Teiler 55.4 (10.) 71.6 (9.) 79.0 (2.)
 Trefferlage 3.13 mm links, 0.11 mm tief
 Streuwert 4.94, horizontal: 6.66, vertikal: 2.09

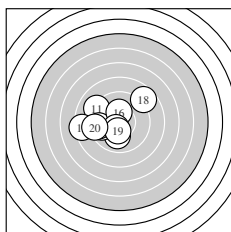

Serie 2:
 9.1 ↘ 10.0 ↓ 8.3 ← 9.7 ← 9.5 ←
 10.3 * 10.5 * 8.7 ↗ 10.3 * 9.2 ←
 beste Teiler 113.7 (17.) 153.1 (19.) 172.2 (16.)
 Trefferlage 1.86 mm links, 0.00 mm
 Streuwert 2.54, horizontal: 3.00, vertikal: 1.98

Unterschrift des Schützen

Ergebnis: **195.6** (185)
 Serien: 95.0 100.6
 Zähler: 7 11 2 0 0 0 0 0 0 0
 Innenzehner: 7
 weiteste: 626 (7), 605 (1), 471 (6)
 beste Teiler 83.7 (15.) 116.8 (3.) 132.0 (19.)
 Trefferlage 0.26 mm links, 0.11 mm tief
 Streuwert 2.36, horizontal: 2.96, vertikal: 1.55

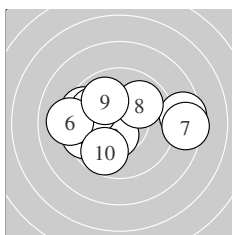
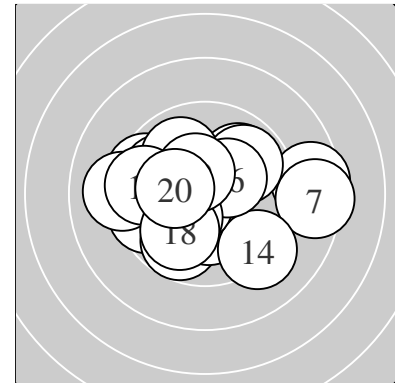

Serie 1:
 8.5 → 9.6 ← 10.5 * 9.5 ↖ 9.9 ↗
 9.1 ← 8.4 → 9.9 ↗ 9.9 ↖ 9.7 ↘
 beste Teiler 116.8 (3.) 253.5 (9.) 258.8 (8.)
 Trefferlage 0.29 mm links, 0.19 mm hoch
 Streuwert 2.91, horizontal: 3.84, vertikal: 1.50

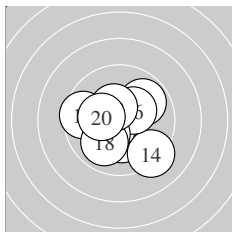

Serie 2:
 10.2 * 9.6 ← 9.9 ↗ 9.2 ↘ 10.6 *
 10.3 * 10.2 * 9.9 ↘ 10.4 * 10.3 *
 beste Teiler 83.7 (15.) 132.0 (19.) 156.2 (16.)
 Trefferlage 0.24 mm links, 0.43 mm tief
 Streuwert 1.78, horizontal: 1.94, vertikal: 1.61

Unterschrift des Schützen

LG 20 ZR – Wertung – Jugend_I_männl.

StandNr: 120

Huter,, Jacob #70110047

StartNr: 20

25. Februar 2018 14:58

SG_Nassereith

Ergebnis: **0.0** (0)_{DNS}
Serien:
Zähler: 0 0 0 0 0 0 0 0 0 0
Innenzehner: 0
weiteste:
~~beste~~ Teiler – Schütze ist nicht zum Wettkampf angetreten
Trefferlage 0.00 mm , 0.00 mm
Streuwert
Unterschrift des Schützen

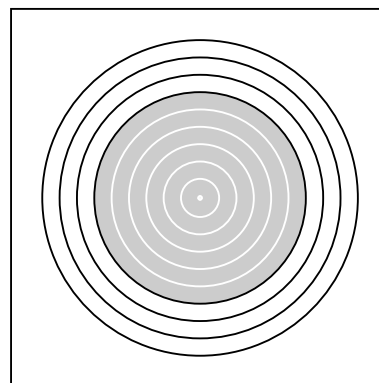

Ergebnis: **197.8** (189)
 Serien: 98.4 99.4
 Zähler: 13 4 2 1 0 0 0 0 0 0
 Innenzehner: 10
 weiteste: 832 (8), 583 (17), 572 (9)
 beste Teiler 41.7 (19.) 49.6 (2.) 59.0 (15.)
 Trefferlage 0.50 mm rechts, 0.26 mm tief
 Streuwert 2.40, horizontal: 3.13, vertikal: 1.32

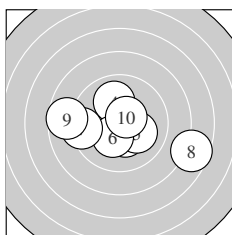
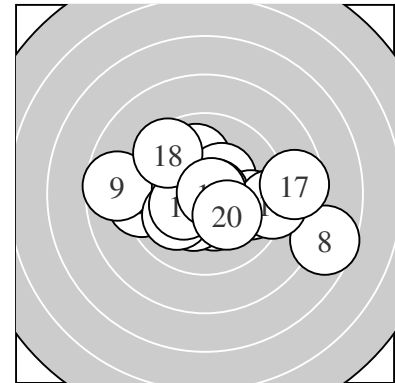

Serie 1:
 10.3 * 10.8 * 10.7 * 10.0 ↑ 10.1 ↘
 10.3 * 9.3 ← 7.6 → 8.7 ← 10.6 *
 beste Teiler 49.6 (2.) 72.9 (3.) 97.0 (10.)
 Trefferlage 0.09 mm links, 0.48 mm tief
 Streuwert 2.73, horizontal: 3.58, vertikal: 1.43

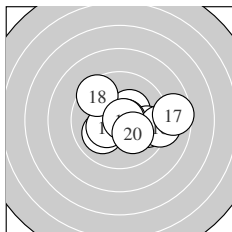

Serie 2:
 10.0 ↙ 10.4 * 9.7 → 10.3 * 10.7 *
 9.2 → 8.6 → 9.5 ↘ 10.8 * 10.2 *
 beste Teiler 41.7 (19.) 59.0 (15.) 150.6 (12.)
 Trefferlage 1.09 mm rechts, 0.04 mm tief
 Streuwert 2.08, horizontal: 2.67, vertikal: 1.24

Unterschrift des Schützen

Ergebnis: **189.4** (180)
 Serien: 94.3 95.1
 Zähler: 8 8 1 2 1 0 0 0 0 0
 Innenzehner: 4
 weiteste: 1053 (7), 790 (17), 764 (4)
 beste Teiler 80.5 (15.) 101.3 (2.) 189.4 (19.)
 Trefferlage 0.19 mm links, 0.22 mm hoch
 Streuwert 3.21, horizontal: 4.12, vertikal: 1.90

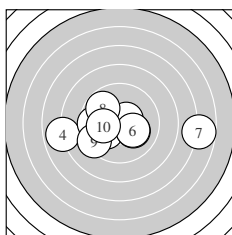
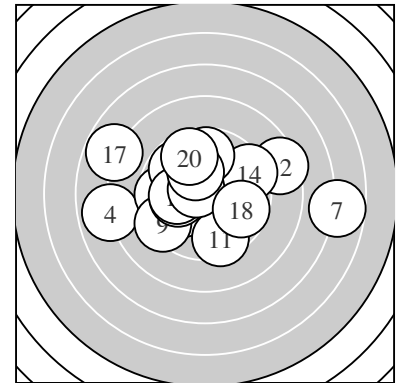

Serie 1:
 10.1 ↙ 10.5 * 10.1 ↘ 7.9 ← 9.6 ←
 10.2 * 6.7 → 9.8 ↖ 9.3 ↙ 10.1 ←
 beste Teiler 101.3 (2.) 197.2 (6.) 206.8 (3.)
 Trefferlage 0.54 mm links, 0.59 mm tief
 Streuwert 3.48, horizontal: 4.77, vertikal: 1.20

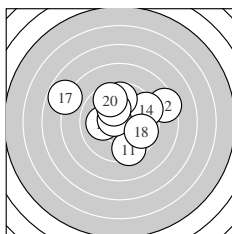

Serie 2:
 9.5 ↓ 8.4 → 10.1 ← 9.4 → 10.6 *
 9.7 ↑ 7.8 ↖ 9.7 → 10.2 * 9.7 ↖
 beste Teiler 80.5 (15.) 189.4 (19.) 221.3 (13.)
 Trefferlage 0.14 mm rechts, 1.05 mm hoch
 Streuwert 2.96, horizontal: 3.59, vertikal: 2.17

Unterschrift des Schützen

Ergebnis: **180.7** (173)
 Serien: 90.5 90.2
 Zähler: 6 6 5 1 2 0 0 0 0 0
 Innenzehner: 4
 weiteste: 1066 (4), 1057 (14), 845 (6)
 beste Teiler 150.8 (1.) 154.3 (8.) 162.6 (9.)
 Trefferlage 2.78 mm links, 0.09 mm tief
 Streuwert 3.45, horizontal: 4.47, vertikal: 1.98

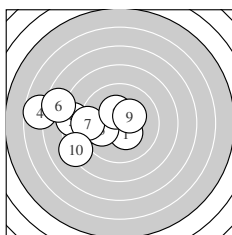
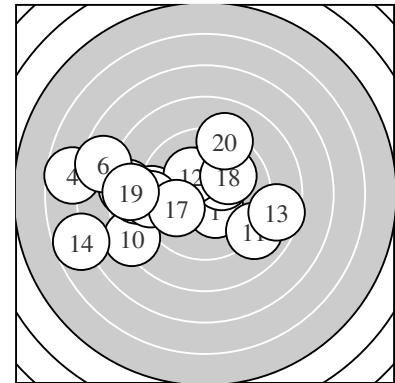

Serie 1:
 10.4 * 9.3 ← 10.0 ← 6.7 ← 8.4 ←
 7.6 ↙ 9.3 ← 10.3 * 10.3 * 8.2 ↙
 beste Teiler 150.8 (1.) 154.3 (8.) 162.6 (9.)
 Trefferlage 3.98 mm links, 0.06 mm hoch
 Streuwert 2.99, horizontal: 3.87, vertikal: 1.69

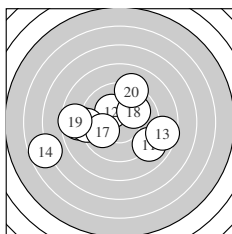

Serie 2:
 9.0 ↘ 10.2 * 8.6 → 6.7 ← 8.8 ←
 9.2 ← 9.9 ← 10.0 ↗ 8.6 ← 9.2 ↑
 beste Teiler 180.2 (12.) 234.6 (18.) 253.5 (17.)
 Trefferlage 1.58 mm links, 0.26 mm tief
 Streuwert 3.83, horizontal: 4.89, vertikal: 2.31

Unterschrift des Schützen

Ergebnis: **197.3** (189)
 Serien: 99.2 98.1
 Zähler: 12 5 3 0 0 0 0 0 0 0
 Innenzehner: 10
 weiteste: 544 (19), 539 (2), 506 (6)
 beste Teiler 68.8 (17.) 97.8 (9.) 115.0 (5.)
 Trefferlage 0.20 mm rechts, 0.81 mm tief
 Streuwert 2.20, horizontal: 2.80, vertikal: 1.34

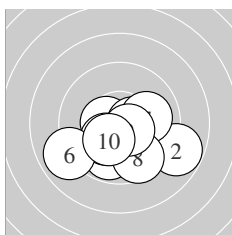
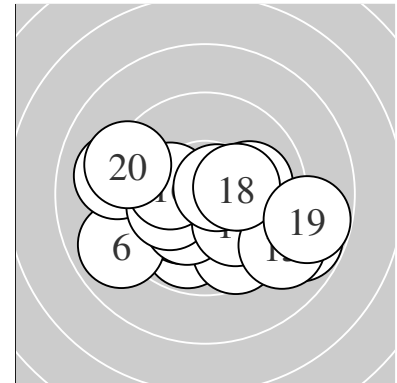

Serie 1:
 10.5 * 8.8 ↘ 9.8 ↙ 10.2 * 10.5 *
 8.9 ↙ 10.0 → 9.6 ↘ 10.6 * 10.3 *
 beste Teiler 97.8 (9.) 115.0 (5.) 115.1 (1.)
 Trefferlage 0.22 mm rechts, 1.32 mm tief
 Streuwert 1.98, horizontal: 2.50, vertikal: 1.27

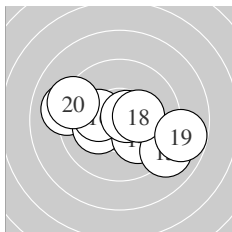

Serie 2:
 9.1 ← 10.5 * 10.2 * 10.1 ↘ 9.0 ↘
 10.2 * 10.7 * 10.3 * 8.8 → 9.2 ↙
 beste Teiler 68.8 (17.) 115.1 (12.) 166.7 (18.)
 Trefferlage 0.19 mm rechts, 0.30 mm tief
 Streuwert 2.44, horizontal: 3.22, vertikal: 1.26

Unterschrift des Schützen

Ergebnis: **188.4** (179)
 Serien: 94.1 94.3
 Zähler: 7 7 4 2 0 0 0 0 0 0
 Innenzehner: 5
 weiteste: 833 (18), 810 (9), 746 (16)
 beste Teiler 58.0 (1.) 72.4 (2.) 99.9 (13.)
 Trefferlage 1.83 mm links, 0.45 mm hoch
 Streuwert 3.01, horizontal: 4.13, vertikal: 1.05

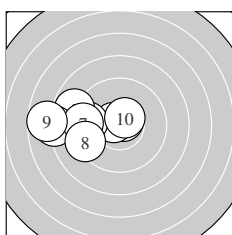
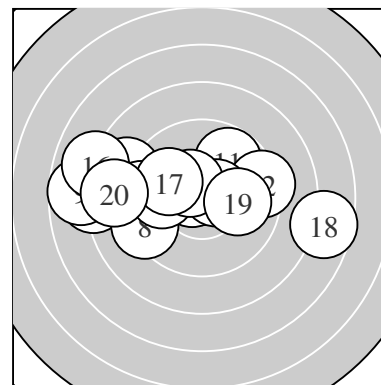

Serie 1:
 10.7 * 10.7 * 9.5 ← 9.5 ← 8.8 ↖
 8.0 ← 9.3 ← 9.3 ↙ 7.7 ← 10.6 *
 beste Teiler 58.0 (1.) 72.4 (2.) 100.4 (10.)
 Trefferlage 3.51 mm links, 0.26 mm hoch
 Streuwert 2.17, horizontal: 2.94, vertikal: 0.90

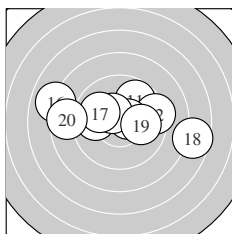

Serie 2:
 9.8 ↗ 9.3 → 10.6 * 9.9 ← 10.5 *
 8.0 ↖ 10.0 ↖ 7.6 → 10.0 → 8.6 ←
 beste Teiler 99.9 (13.) 125.8 (15.) 239.4 (19.)
 Trefferlage 0.15 mm links, 0.64 mm hoch
 Streuwert 3.35, horizontal: 4.59, vertikal: 1.21

Unterschrift des Schützen

Ergebnis: **169.4** (160)
 Serien: 93.5 75.9
ISSF 8.8.2.1a
 Zähler: 1 12 0 4 1 2 0 0 0 0
 Innenzehner: 0
 weiteste: 1322 (14), 1288 (12), 1082 (16)
 beste Teiler 236.3 (6.) 271.1 (7.) 275.1 (5.)
 Trefferlage 0.53 mm rechts, 1.24 mm tief
 Streuwert 4.86, horizontal: 6.61, vertikal: 1.89

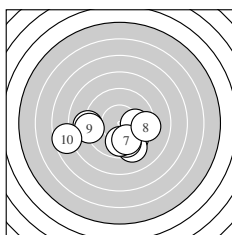
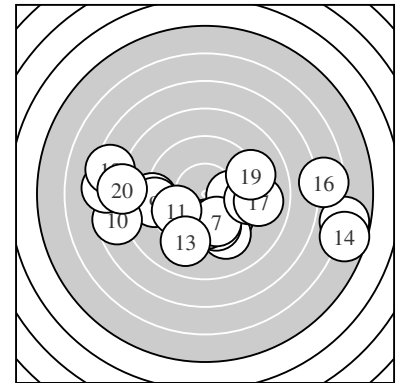

Serie 1:
 9.7 ↘ 9.0 ← 9.3 ↘ 9.7 ↘ 9.9 ↓
 10.0 → 9.9 ↘ 9.3 → 9.1 ← 7.6 ←
 beste Teiler 236.3 (6.) 271.1 (7.) 275.1 (5.)
 Trefferlage 0.48 mm links, 1.80 mm tief
 Streuwert 2.90, horizontal: 3.90, vertikal: 1.25

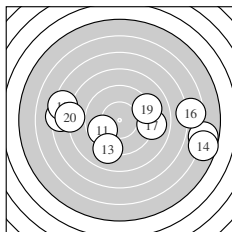

Serie 2:
 9.8 ↙ 5.8 → 9.1 ↓ 5.7 → 7.4 ←
 6.6 → 9.0 → 7.4 ← 9.2 → 7.9 ←
 beste Teiler 297.9 (11.) 449.0 (19.) 464.4 (13.)
 Trefferlage 1.56 mm rechts, 0.68 mm tief
 Streuwert 6.32, horizontal: 8.65, vertikal: 2.29

ISSF 8.8.2.1a – zu viele Wertungsschüsse abgegeben (-2)

Unterschrift des Schützen

Ergebnis: **187.3** (177)
 Serien: 96.2 91.1
 Zähler: 8 5 5 0 2 0 0 0 0 0
 Innenzehner: 7
 weiteste: 1215 (17), 1061 (11), 669 (13)
 beste Teiler 55.3 (6.) 96.6 (19.) 99.9 (18.)
 Trefferlage 2.54 mm links, 0.05 mm tief
 Streuwert 3.19, horizontal: 4.26, vertikal: 1.48

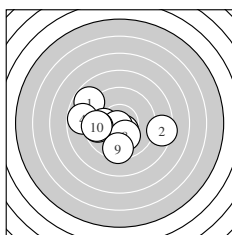
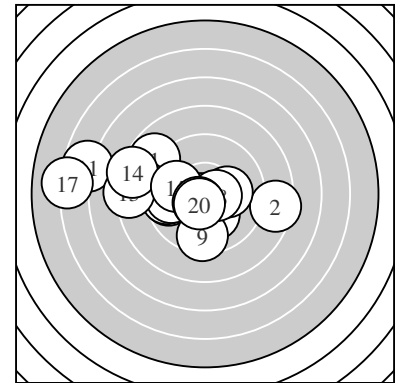

Serie 1:
 8.8 ↘ 8.4 → 10.0 ← 8.8 ← 10.5 *
 10.7 * 9.7 ← 10.2 * 9.5 ↓ 9.6 ←
 beste Teiler 55.3 (6.) 118.0 (5.) 197.8 (8.)
 Trefferlage 1.17 mm links, 0.53 mm tief
 Streuwert 2.67, horizontal: 3.36, vertikal: 1.72

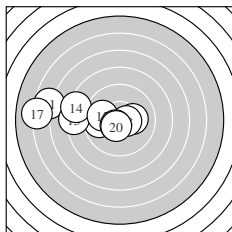

Serie 2:
 6.7 ← 9.8 ← 8.3 ← 8.3 ← 9.9 ←
 10.2 * 6.1 ← 10.6 * 10.6 * 10.6 *
 beste Teiler 96.6 (19.) 99.9 (18.) 100.3 (20.)
 Trefferlage 3.92 mm links, 0.42 mm hoch
 Streuwert 3.47, horizontal: 4.79, vertikal: 1.09

Unterschrift des Schützen

Ergebnis: **177.2** (168)
 Serien: 89.5 87.7
 Zähler: 3 8 5 2 2 0 0 0 0 0
 Innenzehner: 1
 weiteste: 1226 (1), 1100 (11), 868 (12)
 beste Teiler 184.5 (2.) 201.4 (7.) 222.6 (18.)
 Trefferlage 1.44 mm links, 2.77 mm hoch
 Streuwert 3.71, horizontal: 4.77, vertikal: 2.19

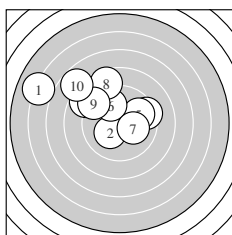
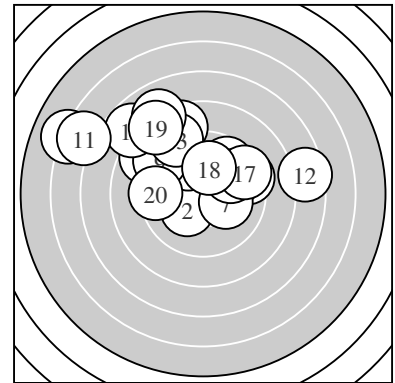

Serie 1:
 6.0 ↖ 10.2 * 8.7 ↖ 9.4 → 9.8 ↗
 9.8 ↘ 10.1 → 8.6 ↗ 9.1 ↖ 7.8 ↘
 beste Teiler 184.5 (2.) 201.4 (7.) 281.7 (6.)
 Trefferlage 2.17 mm links, 2.46 mm hoch
 Streuwert 3.60, horizontal: 4.50, vertikal: 2.36

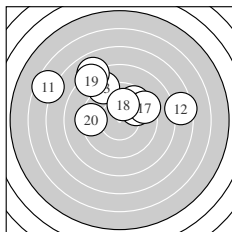

Serie 2:
 6.6 ↖ 7.5 → 8.9 ↘ 9.7 ↗ 9.9 ↗
 8.0 ↘ 9.4 → 10.1 ↑ 8.2 ↘ 9.4 ←
 beste Teiler 222.6 (18.) 274.3 (15.) 322.6 (14.)
 Trefferlage 0.70 mm links, 3.08 mm hoch
 Streuwert 3.93, horizontal: 5.15, vertikal: 2.08

Unterschrift des Schützen

Ergebnis: **204.1** (194)
 Serien: 103.3 100.8
 Zähler: 14 6 0 0 0 0 0 0 0 0
 Innenzehner: 12
 weiteste: 387 (13), 359 (16), 334 (14)
 beste Teiler 53.8 (7.) 64.4 (8.) 65.9 (18.)
 Trefferlage 0.15 mm links, 0.14 mm tief
 Streuwert 1.56, horizontal: 1.91, vertikal: 1.10

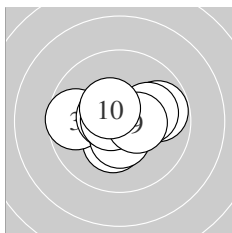
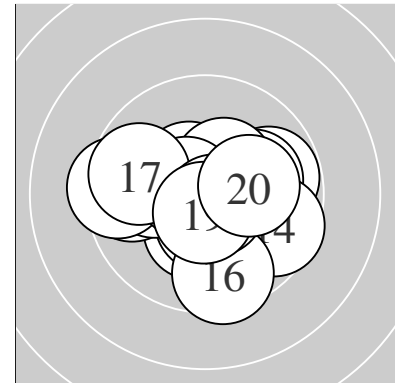

Serie 1:
 9.8 → 10.3 * 9.7 ← 10.1 → 10.5 *
 10.6 * 10.7 * 10.7 * 10.4 * 10.5 *
 beste Teiler 53.8 (7.) 64.4 (8.) 99.6 (6.)
 Trefferlage 0.03 mm links, 0.00 mm
 Streuwert 1.34, horizontal: 1.72, vertikal: 0.81

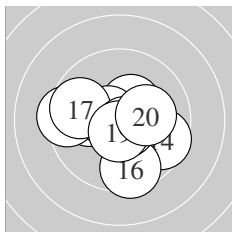

Serie 2:
 10.4 * 10.1 ← 9.4 ← 9.6 → 10.6 *
 9.5 ↓ 9.7 ← 10.7 * 10.6 * 10.2 *
 beste Teiler 65.9 (18.) 83.2 (19.) 87.5 (15.)
 Trefferlage 0.28 mm links, 0.30 mm tief
 Streuwert 1.82, horizontal: 2.18, vertikal: 1.36

Unterschrift des Schützen

Ergebnis: **196.5** (186)
 Serien: 95.6 100.9
 Zähler: 9 9 1 1 0 0 0 0 0 0
 Innenzehner: 8
 weiteste: 869 (5), 514 (19), 456 (12)
 beste Teiler 42.5 (16.) 43.4 (17.) 59.6 (13.)
 Trefferlage 0.75 mm rechts, 0.17 mm hoch
 Streuwert 2.43, horizontal: 3.20, vertikal: 1.24

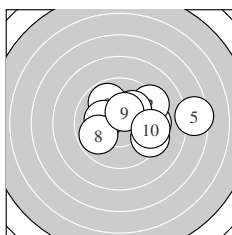
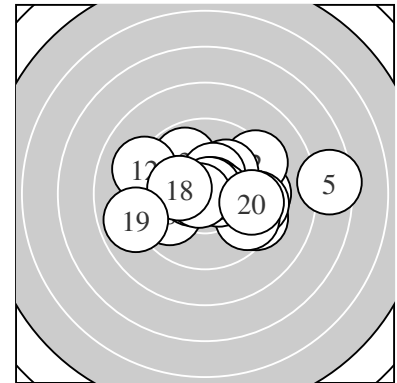

Serie 1:
 9.5 → 9.3 ↗ 9.9 ↖ 10.2 * 7.5 →
 9.4 ↘ 10.1 ↗ 9.8 ↖ 10.4 * 9.5 →
 beste Teiler 142.8 (9.) 191.0 (4.) 212.2 (7.)
 Trefferlage 1.93 mm rechts, 0.49 mm hoch
 Streuwert 2.59, horizontal: 3.39, vertikal: 1.40

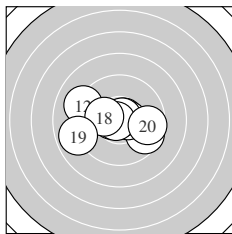

Serie 2:
 10.6 * 9.1 ↖ 10.7 * 9.6 ↘ 10.6 *
 10.8 * 10.8 * 10.2 * 8.9 ↖ 9.6 →
 beste Teiler 42.5 (16.) 43.4 (17.) 59.6 (13.)
 Trefferlage 0.42 mm links, 0.14 mm tief
 Streuwert 2.02, horizontal: 2.66, vertikal: 1.03

Unterschrift des Schützen

Ergebnis: **193.9** (185)
 Serien: 97.8 96.1
 Zähler: 9 8 2 1 0 0 0 0 0 0
 Innenzehner: 7
 weiteste: 963 (2), 618 (11), 603 (15)
 beste Teiler 36.2 (7.) 88.4 (18.) 129.0 (9.)
 Trefferlage 0.04 mm links, 0.64 mm hoch
 Streuwert 2.72, horizontal: 3.61, vertikal: 1.32

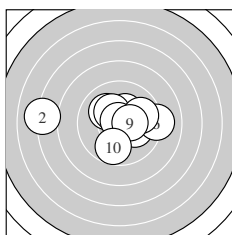
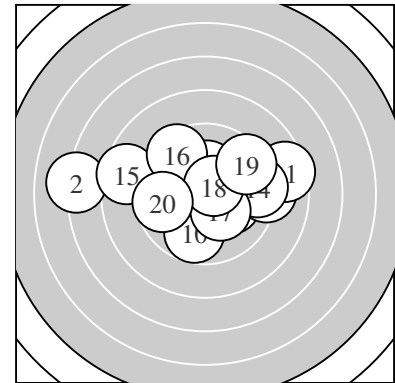

Serie 1:
 10.1 ↖ 7.1 ← 10.1 → 10.3 * 10.3 *
 9.1 → 10.8 * 9.8 ↗ 10.4 * 9.8 ↓
 beste Teiler 36.2 (7.) 129.0 (9.) 158.7 (4.)
 Trefferlage 0.20 mm links, 0.29 mm hoch
 Streuwert 2.84, horizontal: 3.79, vertikal: 1.33

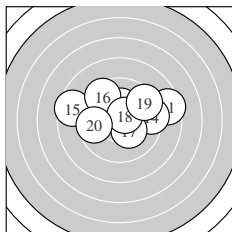

Serie 2:
 8.5 → 9.9 ← 10.3 * 9.4 → 8.5 ←
 9.5 ↘ 10.3 * 10.6 * 9.4 ↗ 9.7 ←
 beste Teiler 88.4 (18.) 169.1 (17.) 174.7 (13.)
 Trefferlage 0.12 mm rechts, 0.98 mm hoch
 Streuwert 2.71, horizontal: 3.61, vertikal: 1.27

Unterschrift des Schützen

Ergebnis: **203.3** (195)
 Serien: 102.8 100.5
 Zähler: 15 5 0 0 0 0 0 0 0 0
 Innenzehner: 11
 weiteste: 378 (19), 354 (16), 299 (17)
 beste Teiler 89.8 (12.) 100.4 (4.) 110.4 (13.)
 Trefferlage 0.17 mm rechts, 0.16 mm hoch
 Streuwert 1.54, horizontal: 1.99, vertikal: 0.89

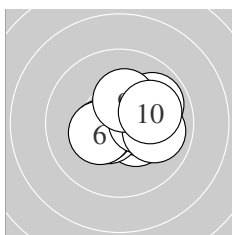
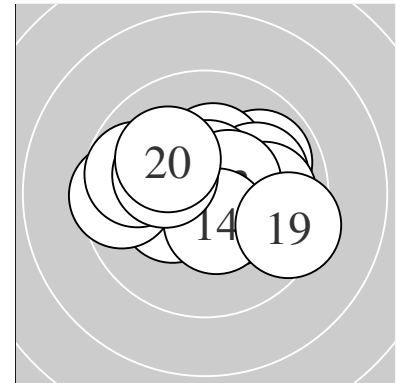

Serie 1:
 9.9 ↗ 10.4 * 10.5 * 10.6 * 10.4 *
 10.3 * 10.4 * 10.0 → 10.3 * 10.0 →
 beste Teiler 100.4 (4.) 114.0 (3.) 134.2 (5.)
 Trefferlage 0.76 mm rechts, 0.05 mm hoch
 Streuwert 1.21, horizontal: 1.45, vertikal: 0.89

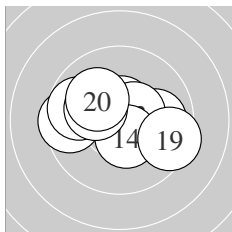

Serie 2:
 9.9 → 10.6 * 10.5 * 10.5 * 10.0 ↖
 9.5 ← 9.8 ← 10.2 * 9.4 → 10.1 ↖
 beste Teiler 89.8 (12.) 110.4 (13.) 125.5 (14.)
 Trefferlage 0.41 mm links, 0.27 mm hoch
 Streuwert 1.77, horizontal: 2.33, vertikal: 0.92

Unterschrift des Schützen

Ergebnis: **196.4** (186)
 Serien: 99.9 96.5
 Zähler: 10 6 4 0 0 0 0 0 0 0
 Innenzehner: 8
 weiteste: 647 (11), 634 (19), 546 (16)
 beste Teiler 30.0 (20.) 55.8 (4.) 132.0 (12.)
 Trefferlage 0.16 mm rechts, 0.36 mm hoch
 Streuwert 2.40, horizontal: 3.11, vertikal: 1.37

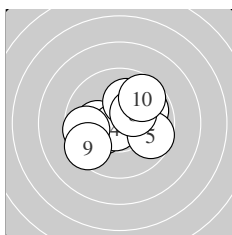
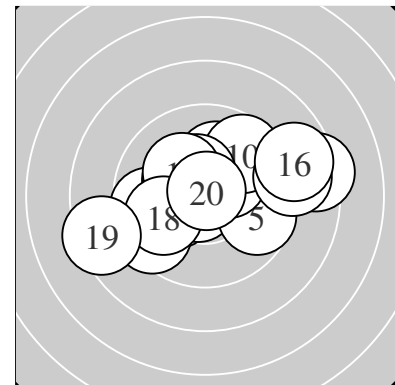

Serie 1:
 9.9 → 10.2 * 10.1 ← 10.7 * 9.7 →
 9.7 ← 10.1 ↑ 10.3 * 9.5 ↙ 9.7 ↗
 beste Teiler 55.8 (4.) 163.6 (8.) 183.4 (2.)
 Trefferlage 0.08 mm links, 0.14 mm hoch
 Streuwert 1.93, horizontal: 2.31, vertikal: 1.47

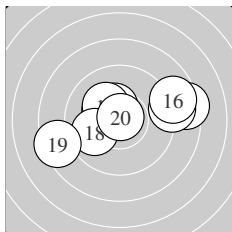

Serie 2:
 8.4 → 10.4 * 8.9 → 10.4 * 10.3 *
 8.8 → 10.2 * 9.9 ← 8.4 ← 10.8 *
 beste Teiler 30.0 (20.) 132.0 (12.) 137.9 (14.)
 Trefferlage 0.42 mm rechts, 0.59 mm hoch
 Streuwert 2.89, horizontal: 3.87, vertikal: 1.30

Unterschrift des Schützen

Ergebnis: **196.5** (187)
 Serien: 96.2 100.3
 Zähler: 11 5 4 0 0 0 0 0 0 0
 Innenzehner: 10
 weiteste: 746 (6), 597 (11), 568 (17)
 beste Teiler 63.6 (8.) 66.2 (18.) 67.4 (14.)
 Trefferlage 0.23 mm links, 0.51 mm tief
 Streuwert 2.48, horizontal: 3.27, vertikal: 1.26

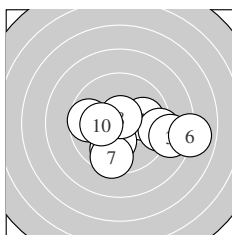
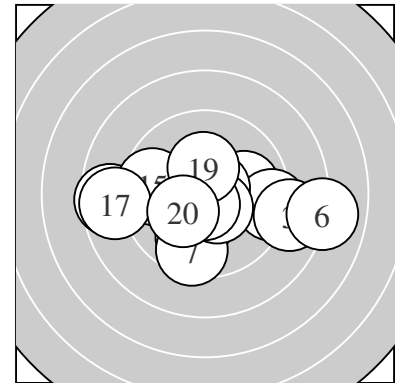

Serie 1:
 10.0 → 9.3 → 8.8 → 9.8 ↓ 10.2 *
 8.0 → 9.5 ↓ 10.7 * 9.7 ← 10.2 *
 beste Teiler 63.6 (8.) 191.3 (10.) 192.8 (5.)
 Trefferlage 1.20 mm rechts, 1.01 mm tief
 Streuwert 2.63, horizontal: 3.44, vertikal: 1.39

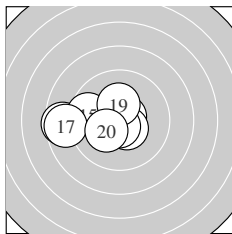

Serie 2:
 8.6 ← 10.4 * 10.5 * 10.7 * 9.6 ←
 10.5 * 8.7 ← 10.7 * 10.3 * 10.3 *
 beste Teiler 66.2 (18.) 67.4 (14.) 114.7 (16.)
 Trefferlage 1.67 mm links, 0.01 mm tief
 Streuwert 1.86, horizontal: 2.47, vertikal: 0.92

Unterschrift des Schützen

Ergebnis: **198.4** (191)
 Serien: 98.2 100.2
 Zähler: 13 5 2 0 0 0 0 0 0 0
 Innenzehner: 9
 weiteste: 700 (8), 501 (12), 463 (2)
 beste Teiler 18.4 (7.) 61.6 (20.) 127.4 (16.)
 Trefferlage 0.84 mm rechts, 0.17 mm hoch
 Streuwert 2.12, horizontal: 2.84, vertikal: 0.97

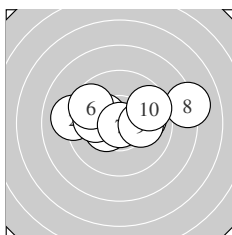
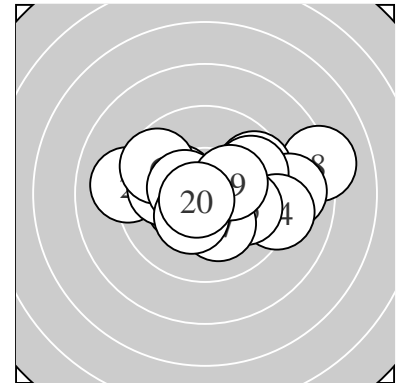

Serie 1:
 10.0 → 9.1 ← 10.3 * 10.4 * 10.0 ←
 9.6 ↖ 10.9 * 8.2 → 10.1 → 9.6 ↗
 beste Teiler 18.4 (7.) 141.9 (4.) 173.3 (3.)
 Trefferlage 0.15 mm rechts, 0.60 mm hoch
 Streuwert 2.47, horizontal: 3.39, vertikal: 0.82

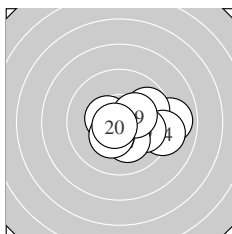

Serie 2:
 10.4 * 8.9 → 9.8 ↗ 9.2 ↘ 10.0 ↘
 10.4 * 10.2 * 10.3 * 10.3 * 10.7 *
 beste Teiler 61.6 (20.) 127.4 (16.) 132.4 (11.)
 Trefferlage 1.54 mm rechts, 0.25 mm tief
 Streuwert 1.63, horizontal: 2.10, vertikal: 0.96

Unterschrift des Schützen

Ergebnis: **194.9** (186)
 Serien: 96.6 98.3
 Zähler: 9 9 1 1 0 0 0 0 0 0
 Innenzehner: 7
 weiteste: 925 (2), 683 (14), 480 (20)
 beste Teiler 68.6 (19.) 69.2 (15.) 73.3 (5.)
 Trefferlage 1.01 mm rechts, 0.46 mm hoch
 Streuwert 2.59, horizontal: 3.44, vertikal: 1.27

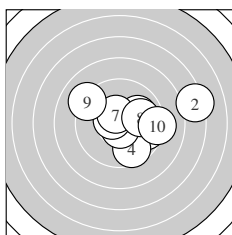
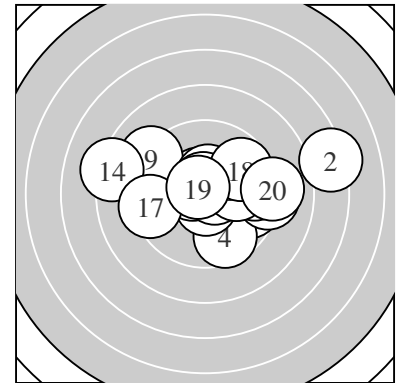

Serie 1:
 10.0 → 7.3 → 9.7 → 9.6 ↘ 10.7 *
 10.6 * 10.5 * 9.9 → 9.1 ↖ 9.2 →
 beste Teiler 73.3 (5.) 94.3 (6.) 115.1 (7.)
 Trefferlage 1.74 mm rechts, 0.31 mm hoch
 Streuwert 2.71, horizontal: 3.46, vertikal: 1.66

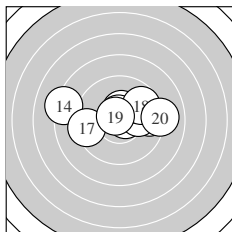

Serie 2:
 9.5 → 10.4 * 10.7 * 8.2 ← 10.7 *
 10.0 → 9.4 ← 9.7 ↗ 10.7 * 9.0 →
 beste Teiler 68.6 (19.) 69.2 (15.) 74.1 (13.)
 Trefferlage 0.28 mm rechts, 0.61 mm hoch
 Streuwert 2.49, horizontal: 3.43, vertikal: 0.80

Unterschrift des Schützen

Ergebnis: **199.0** (189)
 Serien: 100.7 98.3
 Zähler: 10 9 1 0 0 0 0 0 0 0
 Innenzehner: 8
 weiteste: 615 (19), 410 (10), 348 (11)
 beste Teiler 69.3 (13.) 97.4 (5.) 147.0 (6.)
 Trefferlage 0.22 mm rechts, 0.32 mm tief
 Streuwert 2.00, horizontal: 2.42, vertikal: 1.45

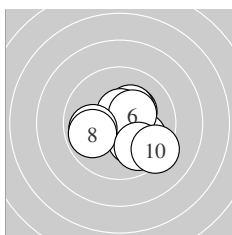
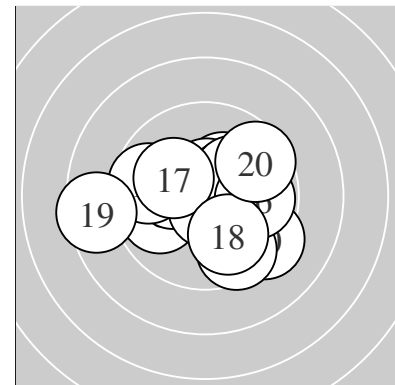

Serie 1:
 10.3 * 10.2 * 10.0 ↘ 10.3 * 10.6 *
 10.4 * 9.9 ← 9.9 ← 9.8 ↘ 9.3 ↘
 beste Teiler 97.4 (5.) 147.0 (6.) 166.2 (4.)
 Trefferlage 0.68 mm rechts, 0.46 mm tief
 Streuwert 1.67, horizontal: 1.88, vertikal: 1.43

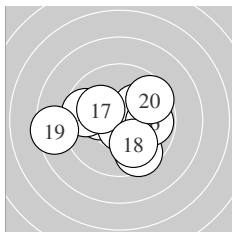

Serie 2:
 9.6 ↘ 10.2 * 10.7 * 9.7 ← 10.2 *
 9.8 → 10.1 ↖ 9.9 ↘ 8.5 ← 9.6 ↗
 beste Teiler 69.3 (13.) 182.4 (12.) 192.0 (15.)
 Trefferlage 0.23 mm links, 0.18 mm tief
 Streuwert 2.32, horizontal: 2.90, vertikal: 1.54

Unterschrift des Schützen

Ergebnis: **185.9** (175)
 Serien: 101.0 84.9
 Zähler: 7 8 2 1 0 2 0 0 0 0
 Innenzehner: 7
 weiteste: 1431 (16), 1251 (19), 765 (17)
 beste Teiler 88.6 (9.) 103.0 (10.) 152.2 (7.)
 Trefferlage 0.37 mm links, 1.53 mm hoch
 Streuwert 3.76, horizontal: 5.12, vertikal: 1.44

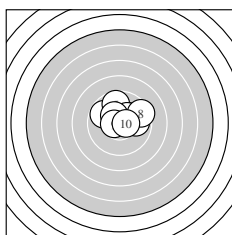
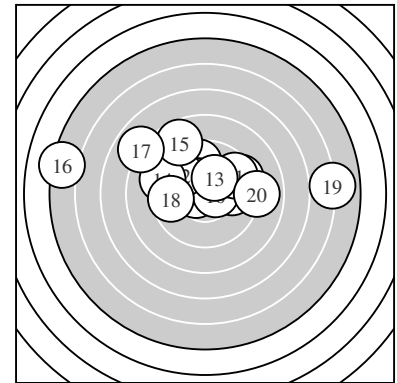

Serie 1:
 10.3 * 10.2 * 9.8 ↖ 9.9 → 9.7 ↑
 10.3 * 10.3 * 9.4 ↗ 10.6 * 10.5 *
 beste Teiler 88.6 (9.) 103.0 (10.) 152.2 (7.)
 Trefferlage 0.39 mm rechts, 1.14 mm hoch
 Streuwert 1.48, horizontal: 1.86, vertikal: 0.97

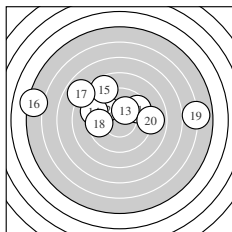

Serie 2:
 9.6 ↗ 9.7 ↖ 10.2 * 9.2 ↖ 8.7 ↖
 5.2 ↖ 7.9 ↖ 9.6 ← 5.9 → 8.9 →
 beste Teiler 182.4 (13.) 301.6 (12.) 338.4 (18.)
 Trefferlage 1.13 mm links, 1.92 mm hoch
 Streuwert 5.18, horizontal: 7.11, vertikal: 1.75

Unterschrift des Schützen

Ergebnis: **173.7** (164)
 Serien: 88.7 85.0
 Zähler: 2 7 6 3 2 0 0 0 0 0
 Innenzehner: 1
 weiteste: 1222 (15), 1042 (20), 995 (1)
 beste Teiler 109.7 (17.) 250.8 (10.) 271.0 (12.)
 Trefferlage 0.82 mm links, 0.45 mm hoch
 Streuwert 4.56, horizontal: 6.00, vertikal: 2.36

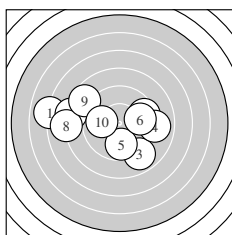
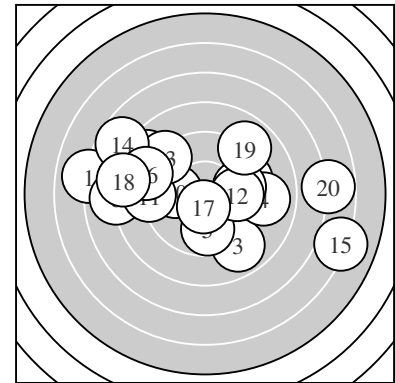

Serie 1:
 7.0 ← 9.5 → 8.9 ↘ 9.0 → 9.8 ↓
 9.8 → 8.2 ← 7.9 ← 8.6 ↖ 10.0 ←
 beste Teiler 250.8 (10.) 295.7 (6.) 296.8 (5.)
 Trefferlage 1.73 mm links, 0.01 mm tief
 Streuwert 4.06, horizontal: 5.30, vertikal: 2.20

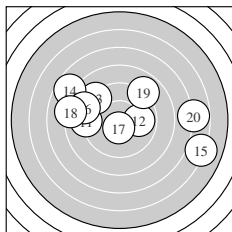

Serie 2:
 9.1 ← 9.9 → 9.1 ↖ 7.7 ↖ 6.1 →
 8.8 ↖ 10.5 * 8.1 ← 8.9 ↗ 6.8 →
 beste Teiler 109.7 (17.) 271.0 (12.) 456.5 (13.)
 Trefferlage 0.08 mm rechts, 0.92 mm hoch
 Streuwert 5.12, horizontal: 6.78, vertikal: 2.54

Unterschrift des Schützen

Ergebnis: **190.9** (181)
 Serien: 97.2 93.7
 Zähler: 7 8 4 1 0 0 0 0 0 0
 Innenzehner: 6
 weiteste: 832 (15), 743 (14), 660 (7)
 beste Teiler 61.8 (1.) 80.9 (6.) 116.9 (19.)
 Trefferlage 1.33 mm rechts, 0.13 mm hoch
 Streuwert 2.82, horizontal: 3.56, vertikal: 1.78

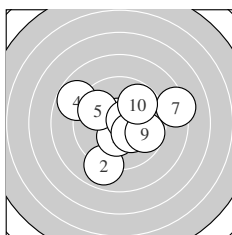
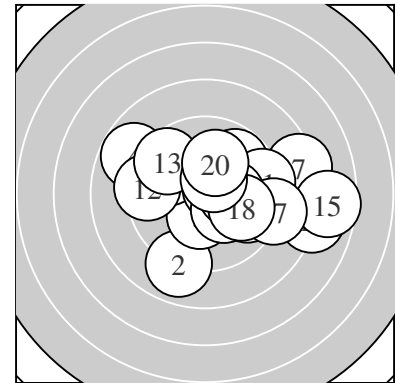

Serie 1:
 10.7 * 8.9 ↙ 10.3 * 8.8 ↖ 9.8 ↗
 10.6 * 8.3 → 10.3 * 9.7 → 9.8 ↗
 beste Teiler 61.8 (1.) 80.9 (6.) 152.0 (3.)
 Trefferlage 0.35 mm rechts, 0.06 mm hoch
 Streuwert 2.69, horizontal: 3.09, vertikal: 2.21

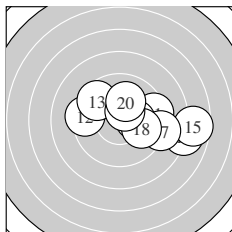

Serie 2:
 9.4 → 9.4 ← 9.6 ↖ 8.0 → 7.6 →
 10.2 * 9.0 → 9.9 → 10.5 * 10.1 ↑
 beste Teiler 116.9 (19.) 177.0 (16.) 221.0 (20.)
 Trefferlage 2.30 mm rechts, 0.20 mm hoch
 Streuwert 2.91, horizontal: 3.89, vertikal: 1.35

Unterschrift des Schützen

Ergebnis: **188.9** (180)
 Serien: 96.6 92.3
 Zähler: 6 10 3 0 1 0 0 0 0 0
 Innenzehner: 3
 weiteste: 1010 (20), 670 (18), 594 (3)
 beste Teiler 103.0 (14.) 105.7 (10.) 173.3 (1.)
 Trefferlage 0.84 mm rechts, 0.36 mm hoch
 Streuwert 3.04, horizontal: 3.69, vertikal: 2.21

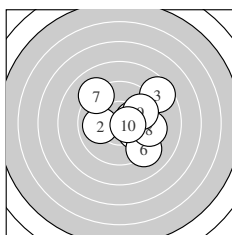
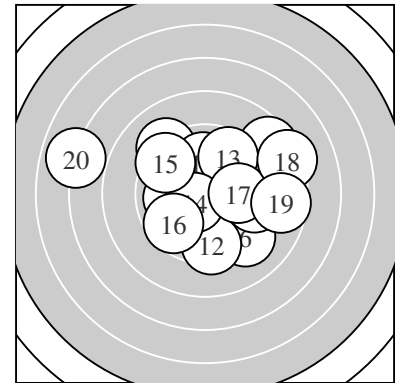

Serie 1:
 10.3 * 10.0 ← 8.6 ↗ 9.6 ↘ 10.1 ↘
 9.2 ↘ 9.1 ↖ 9.4 → 9.8 ↗ 10.5 *
 beste Teiler 105.7 (10.) 173.3 (1.) 223.1 (5.)
 Trefferlage 1.62 mm rechts, 0.17 mm hoch
 Streuwert 2.33, horizontal: 2.49, vertikal: 2.16

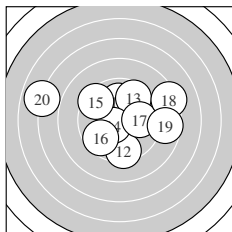

Serie 2:
 10.0 ↑ 9.4 ↓ 9.6 ↗ 10.5 * 9.4 ↘
 9.7 ↙ 9.9 → 8.3 ↗ 8.6 → 6.9 ←
 beste Teiler 103.0 (14.) 240.5 (11.) 251.0 (17.)
 Trefferlage 0.05 mm rechts, 0.55 mm hoch
 Streuwert 3.66, horizontal: 4.60, vertikal: 2.37

Unterschrift des Schützen

Ergebnis: **175.8** (165)
 Serien: 84.0 91.8
 Zähler: 1 10 5 2 1 1 0 0 0 0
 Innenzehner: 1
 weiteste: 1300 (9), 1098 (10), 913 (5)
 beste Teiler 192.3 (2.) 254.6 (11.) 262.0 (20.)
 Trefferlage 1.37 mm links, 1.95 mm tief
 Streuwert 4.11, horizontal: 5.46, vertikal: 1.98

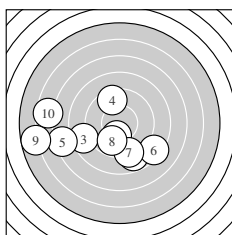
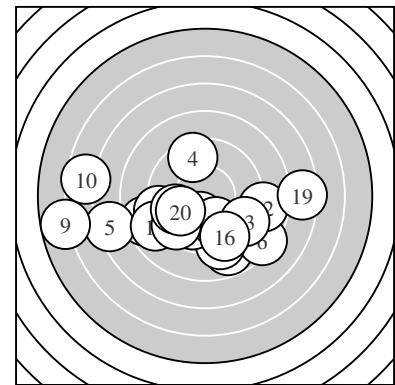

Serie 1:
 8.8 ↘ 10.2 * 8.6 ← 9.5 ↑ 7.3 ←
 8.3 ↘ 9.1 ↓ 9.8 ↓ 5.8 ← 6.6 ←
 beste Teiler 192.3 (2.) 287.0 (8.) 368.4 (4.)
 Trefferlage 3.18 mm links, 2.06 mm tief
 Streuwert 4.63, horizontal: 5.98, vertikal: 2.65

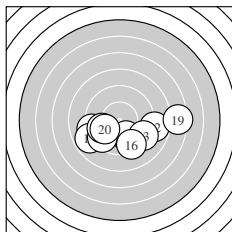

Serie 2:
 9.9 ↘ 8.8 → 9.2 ↘ 9.2 ← 8.8 ←
 9.3 ↘ 9.5 ↙ 9.8 ← 7.4 → 9.9 ←
 beste Teiler 254.6 (11.) 262.0 (20.) 295.4 (18.)
 Trefferlage 0.42 mm rechts, 1.85 mm tief
 Streuwert 3.25, horizontal: 4.47, vertikal: 1.09

Unterschrift des Schützen

Ergebnis: **187.4** (175)
 Serien: 94.1 93.3
 Zähler: 6 8 3 2 0 1 0 0 0 0
 Innenzehner: 5
 weiteste: 1303 (12), 858 (15), 756 (5)
 beste Teiler 28.8 (9.) 79.8 (14.) 86.6 (20.)
 Trefferlage 0.04 mm links, 0.48 mm tief
 Streuwert 3.59, horizontal: 4.79, vertikal: 1.69

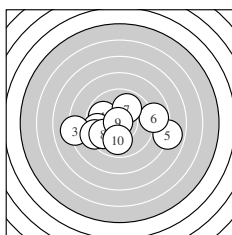
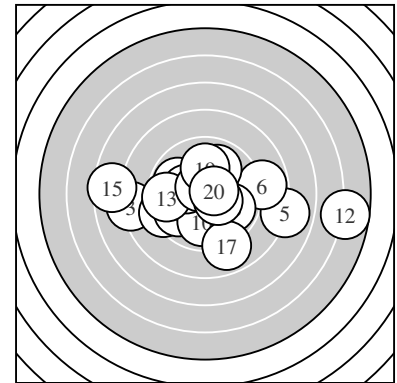

Serie 1:
 9.9 ↖ 9.6 ← 8.2 ← 9.3 ← 7.9 →
 8.8 → 9.9 ↗ 9.8 ↙ 10.8 * 9.9 ↓
 beste Teiler 28.8 (9.) 253.5 (7.) 256.7 (10.)
 Trefferlage 0.58 mm links, 0.52 mm tief
 Streuwert 3.22, horizontal: 4.28, vertikal: 1.55

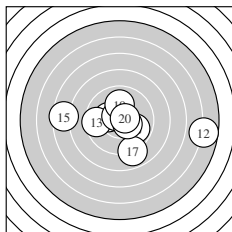

Serie 2:
 10.2 * 5.7 → 9.5 ← 10.6 * 7.5 ←
 9.9 ↘ 8.9 ↓ 10.4 * 10.0 ↑ 10.6 *
 beste Teiler 79.8 (14.) 86.6 (20.) 135.5 (18.)
 Trefferlage 0.49 mm rechts, 0.44 mm tief
 Streuwert 4.07, horizontal: 5.43, vertikal: 1.92

Unterschrift des Schützen

Ergebnis: **198.6** (189)
 Serien: 100.5 98.1
 Zähler: 10 9 1 0 0 0 0 0 0 0
 Innenzehner: 10
 weiteste: 572 (12), 454 (15), 441 (19)
 beste Teiler 54.0 (16.) 75.6 (2.) 109.1 (4.)
 Trefferlage 0.40 mm links, 0.14 mm hoch
 Streuwert 2.12, horizontal: 2.68, vertikal: 1.34

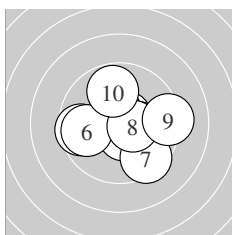
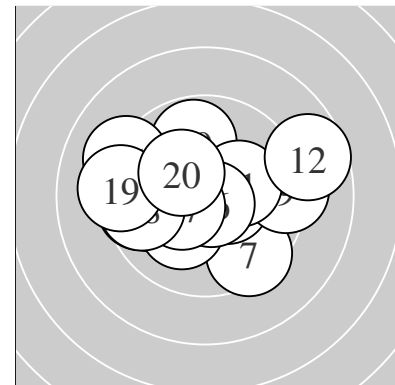

Serie 1:
 9.6 ← 10.7 * 10.5 * 10.5 * 10.3 *
 9.8 ← 9.5 ↘ 10.5 * 9.3 → 9.8 ↑
 beste Teiler 75.6 (2.) 109.1 (4.) 115.7 (3.)
 Trefferlage 0.28 mm rechts, 0.11 mm tief
 Streuwert 1.92, horizontal: 2.27, vertikal: 1.49

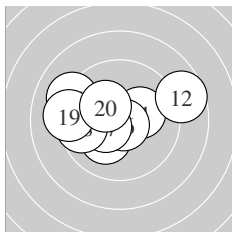

Serie 2:
 10.2 * 8.7 → 10.2 * 9.7 ↖ 9.1 ↖
 10.7 * 10.4 * 9.6 ← 9.2 ← 10.3 *
 beste Teiler 54.0 (16.) 132.4 (17.) 172.5 (20.)
 Trefferlage 1.10 mm links, 0.40 mm hoch
 Streuwert 2.28, horizontal: 2.99, vertikal: 1.18

Unterschrift des Schützen

Ergebnis: **165.9** (156)
 Serien: 83.0 82.9
 Zähler: 2 5 5 5 1 2 0 0 0 0
 Innenzehner: 2
 weiteste: 1393 (17), 1294 (20), 1182 (1)
 beste Teiler 142.6 (9.) 150.2 (13.) 304.6 (10.)
 Trefferlage 0.49 mm rechts, 0.03 mm tief
 Streuwert 5.44, horizontal: 6.66, vertikal: 3.84

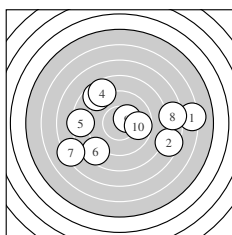
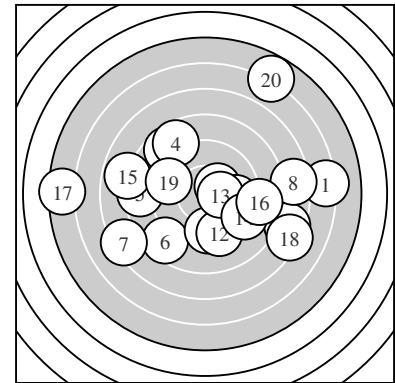

Serie 1:
 6.2 → 7.5 ↘ 8.7 ↖ 8.7 ↖ 8.4 ←
 8.6 ↙ 7.3 ↙ 7.5 → 10.4 * 9.7 →
 beste Teiler 142.6 (9.) 304.6 (10.) 567.1 (3.)
 Trefferlage 0.79 mm rechts, 0.05 mm tief
 Streuwert 5.38, horizontal: 6.85, vertikal: 3.31

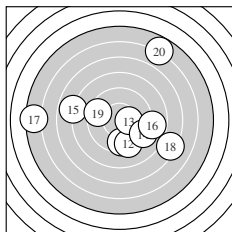

Serie 2:
 9.5 ↓ 9.3 ↓ 10.4 * 9.2 ↘ 7.8 ←
 8.8 → 5.4 ← 7.2 ↘ 9.5 ↖ 5.8 ↗
 beste Teiler 150.2 (13.) 356.9 (11.) 374.7 (19.)
 Trefferlage 0.19 mm rechts, 0.02 mm tief
 Streuwert 5.78, horizontal: 6.83, vertikal: 4.49

Unterschrift des Schützen

Ergebnis: **168.6** (162)
 Serien: 83.5 85.1
 Zähler: 5 4 4 3 3 1 0 0 0 0
 Innenzehner: 3
 weiteste: 1386 (15), 1116 (12), 1055 (20)
 beste Teiler 96.0 (13.) 163.4 (19.) 177.1 (14.)
 Trefferlage 5.16 mm rechts, 0.73 mm tief
 Streuwert 3.76, horizontal: 5.08, vertikal: 1.56

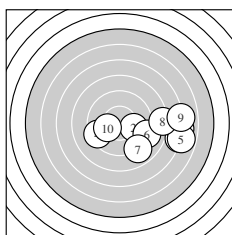
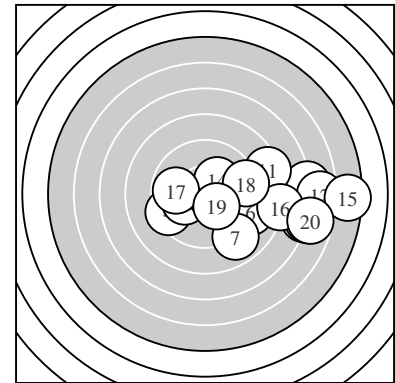

Serie 1:
 7.0 → 10.0 → 7.0 → 9.4 ← 6.8 →
 9.1 → 8.9 ↘ 8.2 → 7.0 → 10.1 ←
 beste Teiler 210.4 (10.) 237.9 (2.) 396.2 (4.)
 Trefferlage 5.04 mm rechts, 1.37 mm tief
 Streuwert 3.73, horizontal: 5.06, vertikal: 1.48

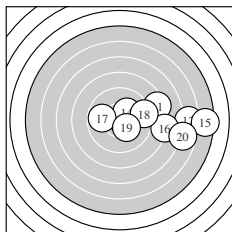

Serie 2:
 8.3 → 6.5 → 10.6 * 10.2 * 5.4 →
 8.0 → 9.8 ← 9.3 → 10.3 * 6.7 →
 beste Teiler 96.0 (13.) 163.4 (19.) 177.1 (14.)
 Trefferlage 5.28 mm rechts, 0.10 mm tief
 Streuwert 3.93, horizontal: 5.37, vertikal: 1.43

Unterschrift des Schützen

Ergebnis: **187.6** (177)
 Serien: 93.0 94.6
 Zähler: 6 6 7 1 0 0 0 0 0 0
 Innenzehner: 5
 weiteste: 813 (3), 711 (7), 684 (10)
 beste Teiler 109.0 (5.) 116.0 (19.) 116.2 (20.)
 Trefferlage 0.87 mm links, 0.16 mm tief
 Streuwert 3.18, horizontal: 3.84, vertikal: 2.34

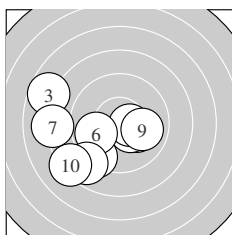
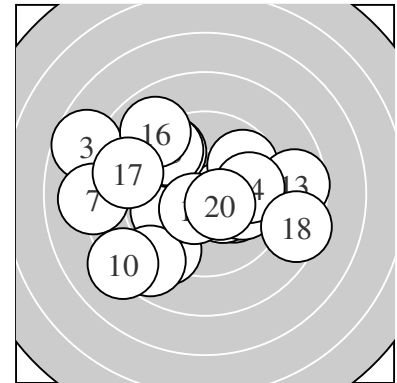

Serie 1:
 10.2 * 9.2 ↙ 7.7 ↖ 10.4 * 10.5 *
 9.9 ← 8.1 ← 8.8 ↙ 10.0 → 8.2 ↙
 beste Teiler 109.0 (5.) 143.4 (4.) 199.9 (1.)
 Trefferlage 2.18 mm links, 1.31 mm tief
 Streuwert 3.06, horizontal: 3.69, vertikal: 2.26

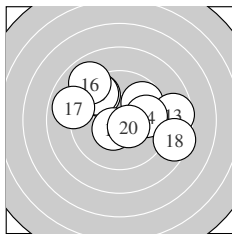

Serie 2:
 9.6 ↘ 9.7 ↗ 8.7 → 9.8 → 9.5 ↘
 8.9 ↘ 8.9 ← 8.5 → 10.5 * 10.5 *
 beste Teiler 116.0 (19.) 116.2 (20.) 283.8 (14.)
 Trefferlage 0.43 mm rechts, 0.98 mm hoch
 Streuwert 2.94, horizontal: 3.70, vertikal: 1.88

Unterschrift des Schützen

Ergebnis: **187.0** (177)
 Serien: 91.7 95.3
 Zähler: 6 6 7 1 0 0 0 0 0 0
 Innenzehner: 6
 weiteste: 877 (4), 658 (10), 641 (19)
 beste Teiler 35.6 (17.) 75.1 (13.) 116.1 (15.)
 Trefferlage 1.02 mm rechts, 0.52 mm hoch
 Streuwert 3.23, horizontal: 3.85, vertikal: 2.46

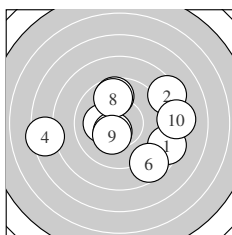
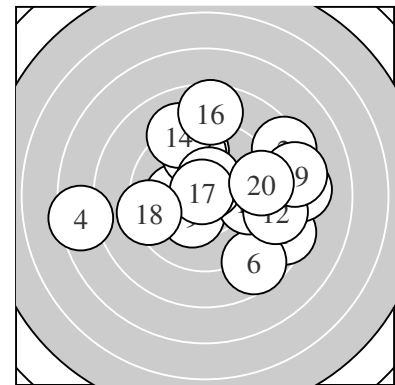

Serie 1:
 8.5 ↘ 8.4 ↗ 10.2 * 7.4 ← 10.4 *
 8.7 ↘ 9.7 ↑ 9.8 ↑ 10.3 * 8.3 →
 beste Teiler 127.1 (5.) 160.8 (9.) 198.0 (3.)
 Trefferlage 0.72 mm rechts, 0.12 mm tief
 Streuwert 3.74, horizontal: 4.60, vertikal: 2.61

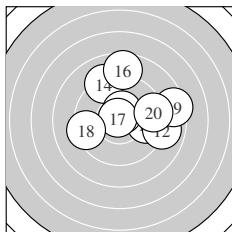

Serie 2:
 9.7 → 8.9 → 10.7 * 9.1 ↖ 10.5 *
 8.6 ↑ 10.8 * 9.3 ← 8.4 → 9.3 →
 beste Teiler 35.6 (17.) 75.1 (13.) 116.1 (15.)
 Trefferlage 1.31 mm rechts, 1.17 mm hoch
 Streuwert 2.73, horizontal: 3.15, vertikal: 2.24

Unterschrift des Schützen