

Ergebnis: **180.9** (170)  
 Serien: 94.7 86.2  
 Zähler: 2 11 4 2 0 1 0 0 0 0  
 Innenzehner: 2  
 weiteste: 1427 (12), 964 (16), 872 (10)  
 beste Teiler 163.8 (5.) 166.7 (1.) 256.0 (7.)  
 Trefferlage 1.14 mm links, 0.65 mm hoch  
 Streuwert 3.97, horizontal: 5.30, vertikal: 1.86

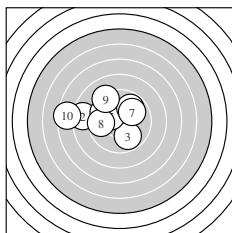

Serie 1:  
 10.3 \*                      8.5 ←                      9.8 ↘                      9.7 ↖                      10.3 \*  
 9.8 ↗                      9.9 ↗                      9.7 ←                      9.2 ↖                      7.5 ←  
 beste Teiler 163.8 (5.) 166.7 (1.) 256.0 (7.)  
 Trefferlage 1.82 mm links, 1.01 mm hoch  
 Streuwert 2.75, horizontal: 3.54, vertikal: 1.59

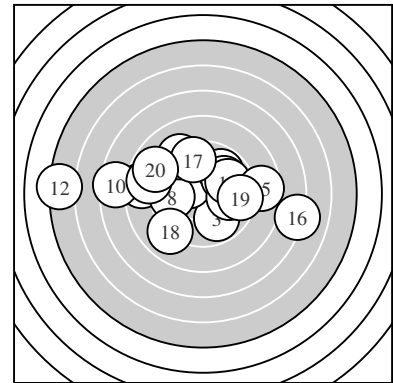
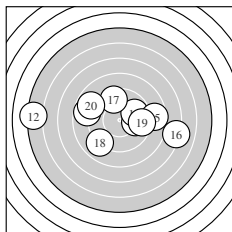

Serie 2:  
 8.7 ←                      5.2 ←                      9.9 →                      9.9 ↗                      8.6 →  
 7.1 →                      9.5 ↑                      9.0 ↙                      9.5 →                      8.8 ↖  
 beste Teiler 260.2 (13.) 274.5 (14.) 353.8 (17.)  
 Trefferlage 0.47 mm links, 0.28 mm hoch  
 Streuwert 5.01, horizontal: 6.76, vertikal: 2.11

Unterschrift des Schützen

Ergebnis: **197.7** (187)  
 Serien: 98.0 99.7  
 Zähler: 8 11 1 0 0 0 0 0 0 0  
 Innenzehner: 7  
 weiteste: 545 (5), 497 (15), 461 (3)  
 beste Teiler 11.6 (10.) 107.3 (12.) 112.0 (13.)  
 Trefferlage 1.43 mm links, 0.07 mm hoch  
 Streuwert 1.92, horizontal: 2.09, vertikal: 1.73

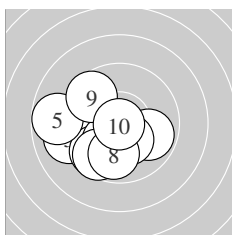
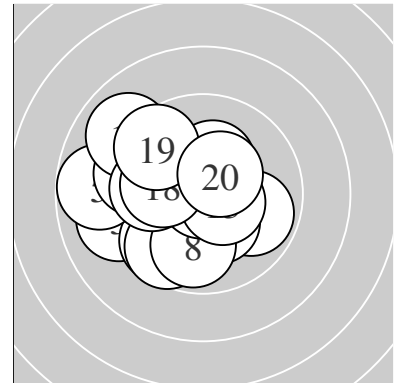

Serie 1:  
 9.9 ↘ 10.3 \* 9.1 ← 9.7 ✓ 8.8 ←  
 10.2 \* 9.6 ✓ 9.9 ↓ 9.6 ↖ 10.9 \*  
 beste Teiler 11.6 (10.) 162.3 (2.) 185.0 (6.)  
 Trefferlage 1.47 mm links, 1.05 mm tief  
 Streuwert 2.00, horizontal: 2.36, vertikal: 1.57

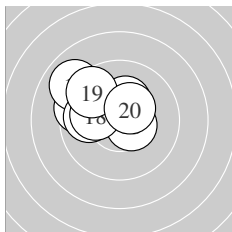

Serie 2:  
 9.9 ↖ 10.5 \* 10.5 \* 9.5 ← 9.0 ↖  
 9.9 ← 10.3 \* 10.1 ← 9.6 ↖ 10.4 \*  
 beste Teiler 107.3 (12.) 112.0 (13.) 137.5 (20.)  
 Trefferlage 1.39 mm links, 1.21 mm hoch  
 Streuwert 1.54, horizontal: 1.92, vertikal: 1.02

Unterschrift des Schützen

Ergebnis: **182.4** (173)  
 Serien: 88.1 94.3  
 Zähler: 4 8 6 1 1 0 0 0 0 0  
 Innenzehner: 3  
 weiteste: 1166 (3), 759 (10), 723 (2)  
 beste Teiler 44.4 (20.) 112.2 (19.) 153.2 (1.)  
 Trefferlage 0.62 mm links, 1.80 mm tief  
 Streuwert 3.60, horizontal: 4.75, vertikal: 1.83

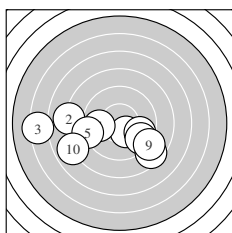
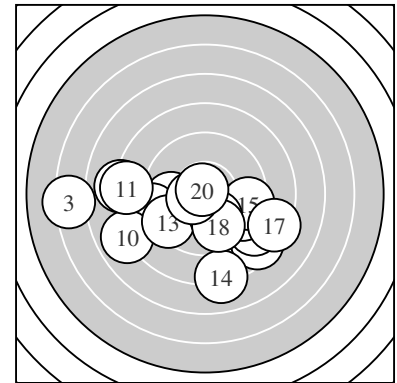

Serie 1:  
 10.3 \*                      8.1 ←                      6.3 ←                      9.8 ←                      9.1 ←  
 9.7 →                      9.5 →                      8.5 →                      8.9 →                      7.9 ←  
 beste Teiler 153.2 (1.) 292.3 (4.) 316.3 (6.)  
 Trefferlage 1.74 mm links, 1.73 mm tief  
 Streuwert 4.13, horizontal: 5.64, vertikal: 1.52

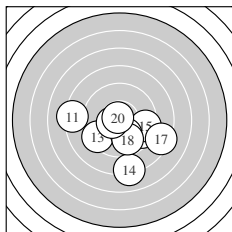

Serie 2:  
 8.3 ←                      9.5 →                      9.4 ↙                      8.1 ↓                      9.4 →  
 10.1 ↓                      8.4 →                      9.8 ↓                      10.5 \*                      10.8 \*  
 beste Teiler 44.4 (20.) 112.2 (19.) 215.6 (16.)  
 Trefferlage 0.50 mm rechts, 1.87 mm tief  
 Streuwert 2.97, horizontal: 3.60, vertikal: 2.18

Unterschrift des Schützen

Ergebnis: **182.2** (174)  
 Serien: 93.4 88.8  
 Zähler: 2 13 2 3 0 0 0 0 0 0  
 Innenzehner: 1  
 weiteste: 900 (14), 888 (19), 839 (3)  
 beste Teiler 104.6 (4.) 210.3 (13.) 257.1 (16.)  
 Trefferlage 0.55 mm links, 1.43 mm hoch  
 Streuwert 3.51, horizontal: 4.45, vertikal: 2.21

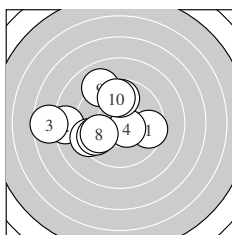
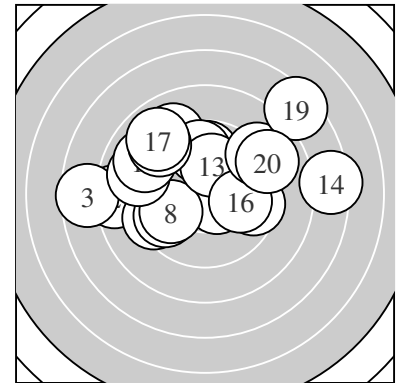

Serie 1:  
 9.5 →                      8.4 ←                      7.6 ←                      10.5 \*                      9.8 ↑  
 9.3 ←                      9.7 ←                      9.9 ←                      9.0 ↖                      9.7 ↑  
 beste Teiler 104.6 (4.) 273.7 (8.) 296.2 (5.)  
 Trefferlage 2.20 mm links, 0.40 mm hoch  
 Streuwert 2.89, horizontal: 3.48, vertikal: 2.15

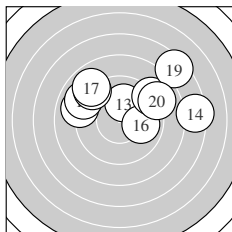

Serie 2:  
 9.0 ↖                      9.0 ↖                      10.1 ↑                      7.4 →                      9.0 ↖  
 9.9 →                      8.9 ↘                      9.1 ↗                      7.4 ↗                      9.0 →  
 beste Teiler 210.3 (13.) 257.1 (16.) 466.4 (18.)  
 Trefferlage 1.09 mm rechts, 2.47 mm hoch  
 Streuwert 3.67, horizontal: 4.86, vertikal: 1.80

Unterschrift des Schützen

Ergebnis: **204.9** (196)  
 Serien: 103.7 101.2  
 Zähler: 16 4 0 0 0 0 0 0 0 0  
 Innenzehner: 14  
 weiteste: 352 (16), 337 (12), 289 (15)  
 beste Teiler 64.8 (11.) 73.8 (7.) 79.6 (4.)  
 Trefferlage 0.00 mm , 0.35 mm hoch  
 Streuwert 1.38, horizontal: 1.80, vertikal: 0.75

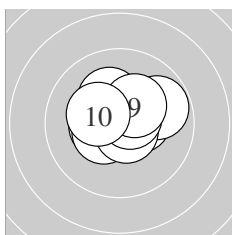
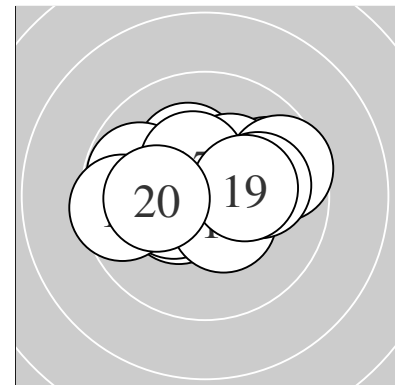

Serie 1:  
 10.4 \*                      10.2 \*                      10.4 \*                      10.6 \*                      10.4 \*  
 9.8 →                      10.7 \*                      10.6 \*                      10.3 \*                      10.3 \*  
 beste Teiler 73.8 (7.) 79.6 (4.) 84.5 (8.)  
 Trefferlage 0.20 mm rechts, 0.44 mm hoch  
 Streuwert 1.10, horizontal: 1.34, vertikal: 0.77

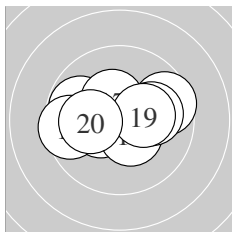

Serie 2:  
 10.7 \*                      9.6 →                      10.4 \*                      10.4 \*                      9.8 ↖  
 9.5 ←                      10.4 \*                      10.0 →                      10.3 \*                      10.1 ←  
 beste Teiler 64.8 (11.) 126.0 (14.) 138.2 (13.)  
 Trefferlage 0.19 mm links, 0.26 mm hoch  
 Streuwert 1.66, horizontal: 2.22, vertikal: 0.76

Unterschrift des Schützen

Ergebnis: **197.4** (191)  
 Serien: 99.1 98.3  
 Zähler: 11 9 0 0 0 0 0 0 0 0  
 Innenzehner: 5  
 weiteste: 486 (2), 478 (5), 458 (11)  
 beste Teiler 56.4 (19.) 72.5 (10.) 97.3 (4.)  
 Trefferlage 0.18 mm links, 0.06 mm hoch  
 Streuwert 2.15, horizontal: 2.52, vertikal: 1.71

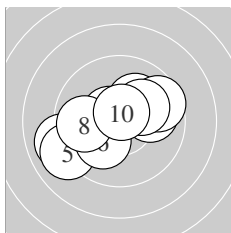
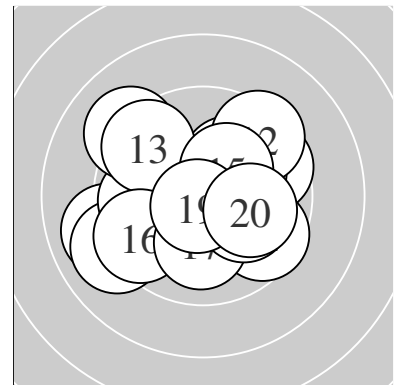

Serie 1:  
 10.0 →                      9.0 ←                      10.2 \*                      10.6 \*                      9.0 ←  
 10.1 ↙                      9.6 →                      9.8 ←                      10.1 ↗                      10.7 \*  
 beste Teiler 72.5 (10.) 97.3 (4.) 200.8 (3.)  
 Trefferlage 0.49 mm links, 0.00 mm  
 Streuwert 2.15, horizontal: 2.70, vertikal: 1.41

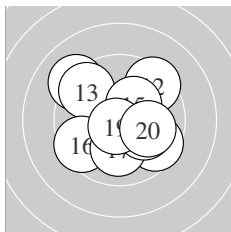

Serie 2:  
 9.1 ↘                      9.4 ↗                      9.5 ↘                      9.6 ↘                      10.3 \*  
 9.5 ↙                      10.1 ↓                      10.1 ↘                      10.7 \*                      10.0 →  
 beste Teiler 56.4 (19.) 167.8 (15.) 217.3 (18.)  
 Trefferlage 0.13 mm rechts, 0.12 mm hoch  
 Streuwert 2.24, horizontal: 2.43, vertikal: 2.04

Unterschrift des Schützen

Ergebnis: **176.0** (166)  
 Serien: 91.8 84.2  
 Zähler: 1 7 10 1 1 0 0 0 0 0  
 Innenzehner: 0  
 weiteste: 1041 (11), 863 (18), 720 (19)  
 beste Teiler 230.7 (13.) 254.1 (7.) 284.6 (4.)  
 Trefferlage 1.14 mm rechts, 4.12 mm tief  
 Streuwert 2.76, horizontal: 3.50, vertikal: 1.74

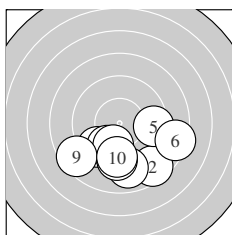
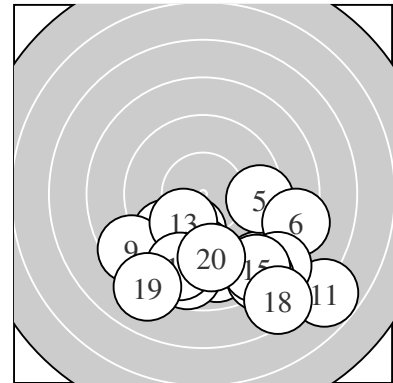

Serie 1:  
 9.5 ↙                      8.6 ↘                      8.9 ↓                      9.8 ✓                      9.4 →  
 8.4 →                      9.9 ↓                      9.3 ↓                      8.5 ✓                      9.5 ↓  
 beste Teiler 254.1 (7.) 284.6 (4.) 360.8 (1.)  
 Trefferlage 0.46 mm rechts, 3.09 mm tief  
 Streuwert 2.51, horizontal: 3.26, vertikal: 1.41

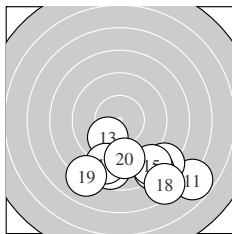

Serie 2:  
 6.8 ↘                      8.2 ↘                      10.0 ✓                      8.3 ↘                      8.5 ↘  
 8.7 ↓                      8.9 ↓                      7.5 ↘                      8.1 ✓                      9.2 ↓  
 beste Teiler 230.7 (13.) 426.5 (20.) 506.0 (17.)  
 Trefferlage 1.83 mm rechts, 5.14 mm tief  
 Streuwert 2.85, horizontal: 3.76, vertikal: 1.44

Unterschrift des Schützen

Ergebnis: **193.8** (182)  
 Serien: 99.3 94.5  
 Zähler: 8 8 2 2 0 0 0 0 0 0  
 Innenzehner: 7  
 weiteste: 829 (11), 768 (1), 686 (19)  
 beste Teiler 65.1 (10.) 71.3 (6.) 80.0 (3.)  
 Trefferlage 1.16 mm rechts, 0.83 mm hoch  
 Streuwert 2.59, horizontal: 3.56, vertikal: 0.88

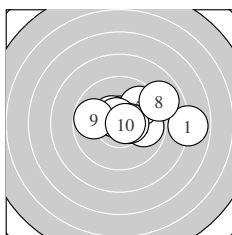
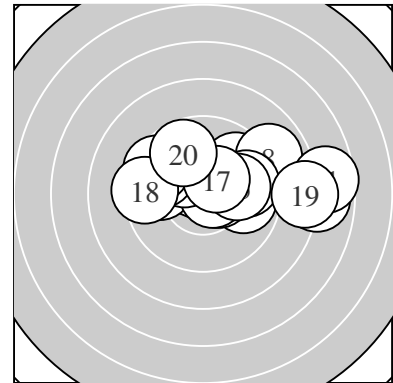

Serie 1:  
 7.9 →                      9.9 →                      10.6 \*                      10.5 \*                      9.8 ↗  
 10.7 \*                      10.5 \*                      8.9 ↖                      9.8 ←                      10.7 \*  
 beste Teiler 65.1 (10.) 71.3 (6.) 80.0 (3.)  
 Trefferlage 1.45 mm rechts, 0.63 mm hoch  
 Streuwert 2.22, horizontal: 2.99, vertikal: 0.94

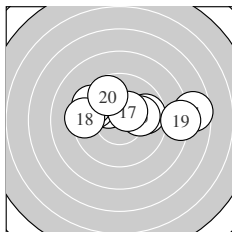

Serie 2:  
 7.6 →                      10.2 \*                      9.8 →                      9.7 ↖                      10.0 →  
 9.5 ↖                      10.4 \*                      9.4 ←                      8.2 →                      9.7 ↖  
 beste Teiler 133.7 (17.) 182.5 (12.) 234.7 (15.)  
 Trefferlage 0.87 mm rechts, 1.04 mm hoch  
 Streuwert 3.02, horizontal: 4.19, vertikal: 0.80

Unterschrift des Schützen



Ergebnis: **0.0** (0)<sub>DNS</sub>  
Serien:  
Zähler: 0 0 0 0 0 0 0 0 0 0  
Innenzehner: 0  
weiteste:  
~~beste Teiler~~ – Schütze ist nicht zum Wettkampf angetreten  
Trefferlage 0.00 mm , 0.00 mm  
Streuwert  
Unterschrift des Schützen

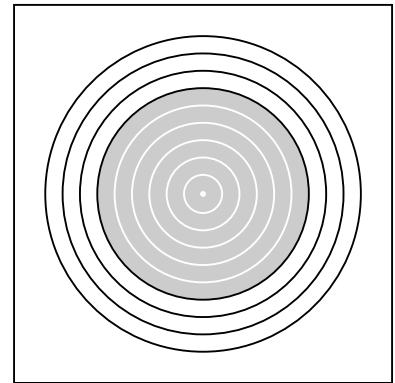

Ergebnis: **189.1** (177)  
 Serien: 92.8 96.3  
 Zähler: 4 10 5 1 0 0 0 0 0 0  
 Innenzehner: 3  
 weiteste: 930 (8), 663 (9), 613 (15)  
 beste Teiler 77.6 (11.) 146.7 (13.) 173.7 (16.)  
 Trefferlage 2.00 mm rechts, 0.78 mm tief  
 Streuwert 2.68, horizontal: 3.18, vertikal: 2.05

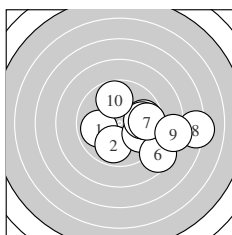
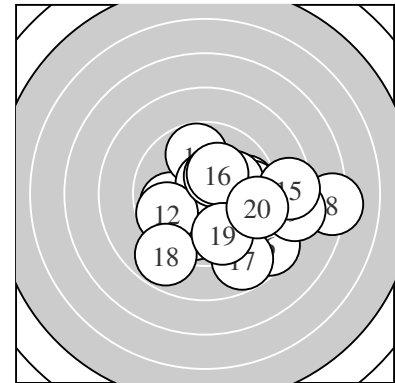

Serie 1:  
 9.9 ←                      9.9 ↓                      9.8 →                      9.8 ↘                      9.9 →  
 8.6 ↘                      9.6 →                      7.2 →                      8.3 →                      9.8 ↑  
 beste Teiler 257.8 (1.) 266.7 (2.) 275.1 (5.)  
 Trefferlage 2.80 mm rechts, 0.61 mm tief  
 Streuwert 2.80, horizontal: 3.53, vertikal: 1.81

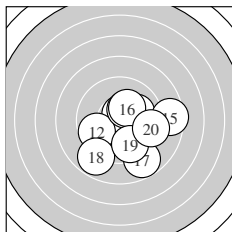

Serie 2:  
 10.6 \*                      9.7 ←                      10.4 \*                      10.1 →                      8.5 →  
 10.3 \*                      8.8 ↘                      8.8 ↙                      9.7 ↓                      9.4 →  
 beste Teiler 77.6 (11.) 146.7 (13.) 173.7 (16.)  
 Trefferlage 1.20 mm rechts, 0.96 mm tief  
 Streuwert 2.55, horizontal: 2.74, vertikal: 2.34

Unterschrift des Schützen

Ergebnis: **0.0** (0)<sub>DNS</sub>

Serien:

Zähler: 0 0 0 0 0 0 0 0 0 0

Innenzehner: 0

weiteste:

beste Teiler – Schütze ist nicht zum Wettkampf angetreten

Trefferlage 0.00 mm , 0.00 mm

Streuwert

Unterschrift des Schützen

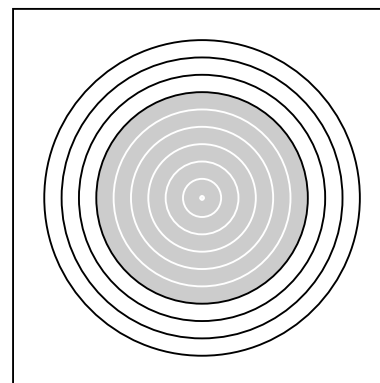

Ergebnis: **172.3** (163)  
 Serien: 86.7 85.6  
 Zähler: 1 7 8 3 0 1 0 0 0 0  
 Innenzehner: 0  
 weiteste: 1284 (6), 972 (14), 861 (3)  
 beste Teiler 216.6 (16.) 287.4 (10.) 316.1 (4.)  
 Trefferlage 2.77 mm links, 2.65 mm hoch  
 Streuwert 3.71, horizontal: 4.95, vertikal: 1.72

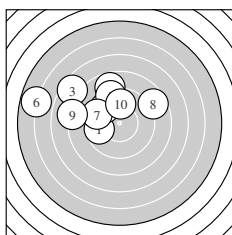
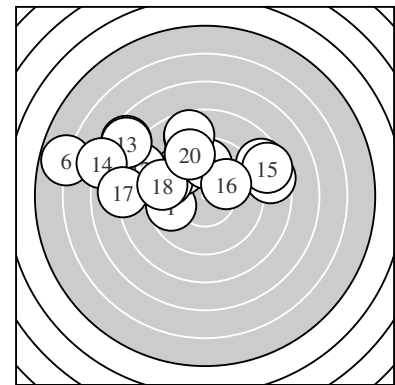

Serie 1:  
 9.7 ←                      8.8 ↑                      7.5 ↘                      9.7 ↘                      9.2 ↑  
 5.8 ←                      9.5 ←                      8.6 ↗                      8.1 ←                      9.8 ↑  
 beste Teiler 287.4 (10.) 316.1 (4.) 316.2 (1.)  
 Trefferlage 3.27 mm links, 2.73 mm hoch  
 Streuwert 3.59, horizontal: 4.73, vertikal: 1.85

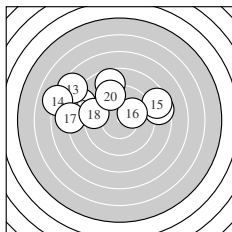

Serie 2:  
 8.5 →                      8.4 ↖                      7.5 ↘                      7.1 ↖                      8.5 →  
 10.1 ↗                      8.0 ←                      9.4 ←                      8.7 ↑                      9.4 ↑  
 beste Teiler 216.6 (16.) 395.8 (18.) 396.4 (20.)  
 Trefferlage 2.27 mm links, 2.58 mm hoch  
 Streuwert 3.98, horizontal: 5.37, vertikal: 1.68

Unterschrift des Schützen

Ergebnis: **200.5** (191)  
 Serien: 99.4 101.1  
 Zähler: 12 7 1 0 0 0 0 0 0 0  
 Innenzehner: 10  
 weiteste: 625 (12), 463 (7), 413 (3)  
 beste Teiler 45.2 (15.) 83.4 (16.) 93.2 (19.)  
 Trefferlage 0.83 mm rechts, 0.04 mm hoch  
 Streuwert 1.88, horizontal: 2.54, vertikal: 0.80

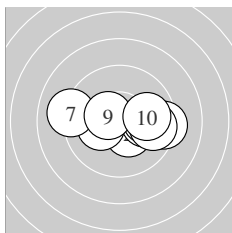
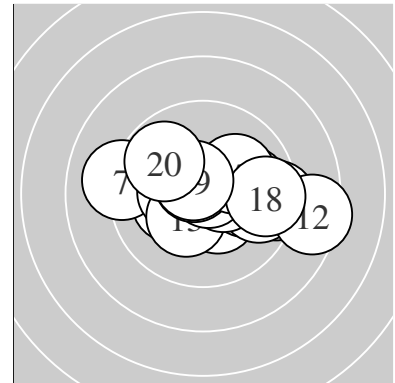

Serie 1:  
 10.4 \*                      10.4 \*                      9.3 →                      10.0 →                      10.2 \*  
 9.9 →                      9.1 ←                      9.7 →                      10.5 \*                      9.9 →  
 beste Teiler 120.3 (9.) 138.6 (2.) 143.6 (1.)  
 Trefferlage 0.94 mm rechts, 0.14 mm tief  
 Streuwert 1.93, horizontal: 2.67, vertikal: 0.59

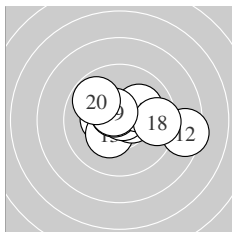

Serie 2:  
 10.4 \*                      8.5 →                      10.3 \*                      10.5 \*                      10.8 \*  
 10.6 \*                      10.1 ↗                      9.5 →                      10.6 \*                      9.8 ↘  
 beste Teiler 45.2 (15.) 83.4 (16.) 93.2 (19.)  
 Trefferlage 0.73 mm rechts, 0.23 mm hoch  
 Streuwert 1.92, horizontal: 2.54, vertikal: 0.96

Unterschrift des Schützen

Ergebnis: **190.6** (183)  
 Serien: 96.6 94.0  
 Zähler: 6 11 3 0 0 0 0 0 0 0  
 Innenzehner: 3  
 weiteste: 716 (18), 704 (17), 591 (2)  
 beste Teiler 53.8 (16.) 69.2 (7.) 198.6 (14.)  
 Trefferlage 0.77 mm links, 1.40 mm tief  
 Streuwert 2.64, horizontal: 3.37, vertikal: 1.60

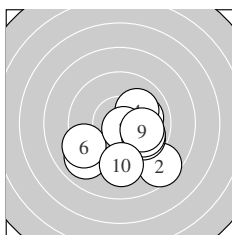
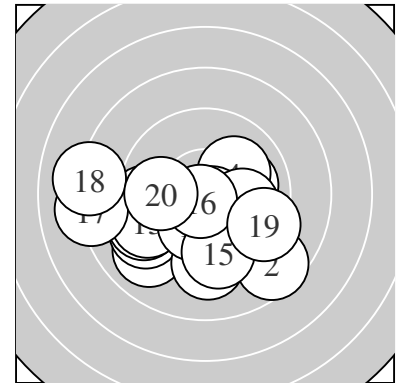

Serie 1:  
 10.0 →                      8.6 ↘                      9.8 ↘                      10.1 ↗                      9.0 ↙  
    9.2 ↖                      10.7 \*                      9.9 ↗                      10.0 →                      9.3 ↓  
 beste Teiler 69.2 (7.) 219.0 (4.) 231.6 (1.)  
 Trefferlage 0.88 mm rechts, 1.64 mm tief  
 Streuwert 2.27, horizontal: 2.57, vertikal: 1.92

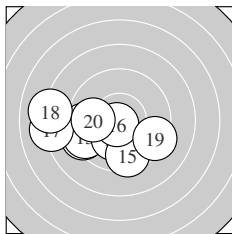

Serie 2:  
    9.5 ←                      9.3 ←                      9.4 ←                      10.2 \*                      9.5 ↓  
 10.7 \*                      8.1 ←                      8.1 ←                      9.3 ↘                      9.9 ←  
 beste Teiler 53.8 (16.) 198.6 (14.) 271.0 (20.)  
 Trefferlage 2.42 mm links, 1.17 mm tief  
 Streuwert 2.54, horizontal: 3.36, vertikal: 1.26

Unterschrift des Schützen

Ergebnis: **202.4** (194)  
 Serien: 100.3 102.1  
 Zähler: 15 4 1 0 0 0 0 0 0 0  
 Innenzehner: 13  
 weiteste: 526 (18), 466 (7), 460 (9)  
 beste Teiler 13.0 (16.) 45.6 (6.) 69.6 (5.)  
 Trefferlage 0.15 mm links, 0.42 mm hoch  
 Streuwert 1.81, horizontal: 2.36, vertikal: 1.01

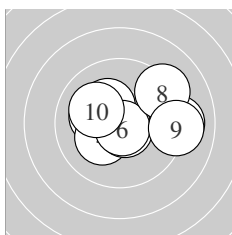
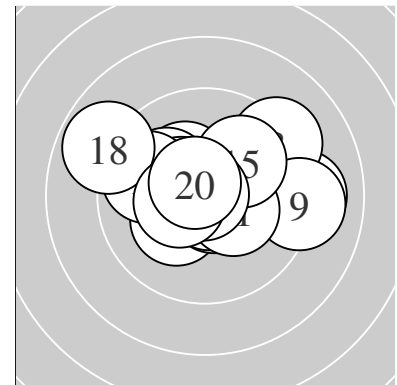

Serie 1:  
 10.2 \*                      10.6 \*                      10.3 \*                      10.2 \*                      10.7 \*  
 10.8 \*                      9.1 →                      9.2 ↗                      9.1 →                      10.1 ↖  
 beste Teiler 45.6 (6.) 69.6 (5.) 95.1 (2.)  
 Trefferlage 0.65 mm rechts, 0.24 mm hoch  
 Streuwert 2.01, horizontal: 2.61, vertikal: 1.14

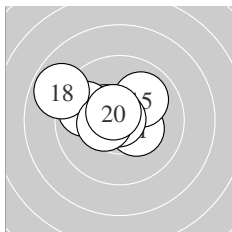

Serie 2:  
 10.3 \*                      10.3 \*                      10.6 \*                      10.4 \*                      10.0 ↗  
 10.9 \*                      9.8 ←                      8.8 ↖                      10.4 \*                      10.6 \*  
 beste Teiler 13.0 (16.) 76.9 (13.) 81.2 (20.)  
 Trefferlage 0.96 mm links, 0.60 mm hoch  
 Streuwert 1.46, horizontal: 1.87, vertikal: 0.89

Unterschrift des Schützen

Ergebnis: **203.4** (195)  
 Serien: 100.5 102.9  
 Zähler: 15 5 0 0 0 0 0 0 0 0  
 Innenzehner: 15  
 weiteste: 446 (12), 432 (5), 374 (10)  
 beste Teiler 87.3 (15.) 91.0 (16.) 113.4 (9.)  
 Trefferlage 0.05 mm rechts, 0.35 mm hoch  
 Streuwert 1.61, horizontal: 1.89, vertikal: 1.28

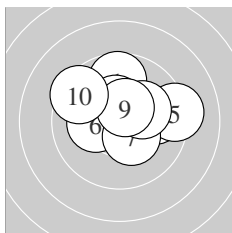
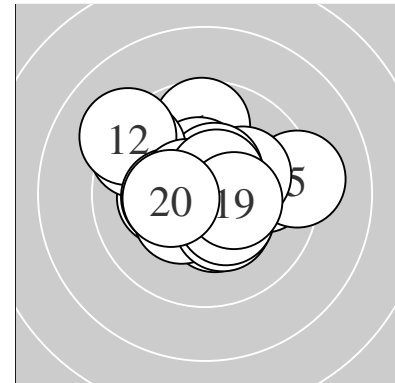

Serie 1:  
 9.7 ↑                      10.5 \*                      10.4 \*                      9.9 →                      9.2 →  
 10.2 \*                      10.4 \*                      10.2 \*                      10.5 \*                      9.5 ↘  
 beste Teiler 113.4 (9.) 120.1 (2.) 134.3 (3.)  
 Trefferlage 0.56 mm rechts, 0.88 mm hoch  
 Streuwert 1.72, horizontal: 2.13, vertikal: 1.17

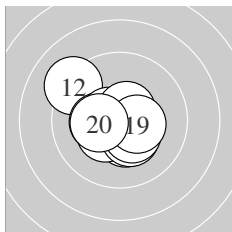

Serie 2:  
 10.4 \*                      9.2 ↘                      10.3 \*                      10.4 \*                      10.6 \*  
 10.6 \*                      10.3 \*                      10.4 \*                      10.4 \*                      10.3 \*  
 beste Teiler 87.3 (15.) 91.0 (16.) 137.5 (19.)  
 Trefferlage 0.46 mm links, 0.17 mm tief  
 Streuwert 1.39, horizontal: 1.55, vertikal: 1.22

Unterschrift des Schützen



Ergebnis: **186.2** (177)  
 Serien: 92.9 93.3  
 Zähler: 7 6 5 1 1 0 0 0 0 0  
 Innenzehner: 4  
 weiteste: 1091 (15), 923 (12), 683 (4)  
 beste Teiler 61.5 (18.) 65.8 (20.) 103.7 (11.)  
 Trefferlage 0.53 mm rechts, 0.51 mm tief  
 Streuwert 3.52, horizontal: 4.51, vertikal: 2.11

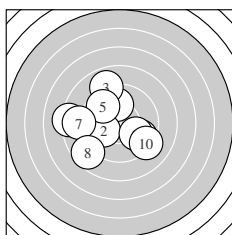
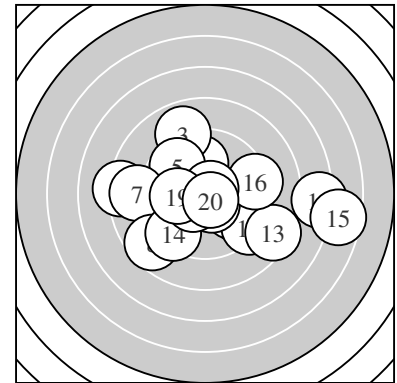

Serie 1:  
 10.0 ↑                      10.0 ←                      8.9 ↗                      8.2 ←                      9.7 ↖  
 9.6 ↘                      8.8 ←                      8.6 ↙                      9.9 ↘                      9.2 ↘  
 beste Teiler 234.5 (2.) 250.7 (1.) 259.6 (9.)  
 Trefferlage 1.45 mm links, 0.06 mm tief  
 Streuwert 3.12, horizontal: 3.52, vertikal: 2.65

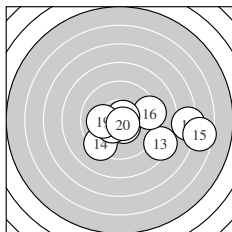

Serie 2:  
 10.5 \*                      7.3 →                      8.4 ↘                      9.3 ↙                      6.6 →  
 9.3 →                      10.4 \*                      10.7 \*                      10.1 ←                      10.7 \*  
 beste Teiler 61.5 (18.) 65.8 (20.) 103.7 (11.)  
 Trefferlage 2.51 mm rechts, 0.96 mm tief  
 Streuwert 3.45, horizontal: 4.68, vertikal: 1.38

Unterschrift des Schützen

Ergebnis: **0.0** (0)<sub>DNS</sub>

Serien:

Zähler: 0 0 0 0 0 0 0 0 0 0

Innenzehner: 0

weiteste:

~~beste Teiler~~ – Schütze ist nicht zum Wettkampf angetreten

Trefferlage 0.00 mm , 0.00 mm

Streuwert

Unterschrift des Schützen

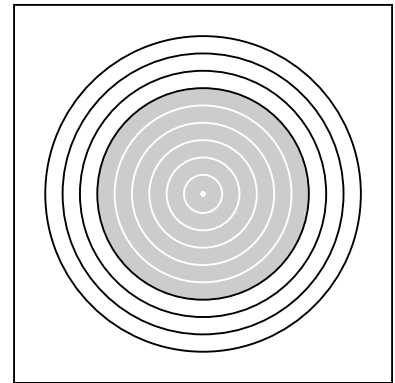

Ergebnis: **174.2** (163)  
 Serien: 81.5 92.7  
 Zähler: 4 6 4 4 1 0 0 1 0 0  
 Innenzehner: 4  
 weiteste: 1823 (10), 1126 (15), 846 (6)  
 beste Teiler 117.4 (12.) 138.5 (4.) 150.9 (11.)  
 Trefferlage 0.00 mm , 0.22 mm tief  
 Streuwert 4.97, horizontal: 6.28, vertikal: 3.14

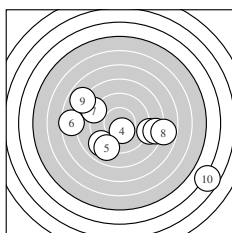
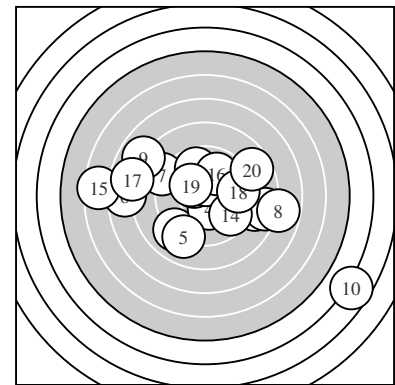

Serie 1:  
 9.0 ↙                      8.8 →                      8.4 →                      10.4 \*                      9.0 ↘  
 7.6 ←                      8.9 ↖                      7.8 →                      7.9 ↗                      3.7 ↘  
 beste Teiler 138.5 (4.) 480.0 (1.) 484.8 (5.)  
 Trefferlage 1.02 mm rechts, 1.68 mm tief  
 Streuwert 5.92, horizontal: 7.49, vertikal: 3.75

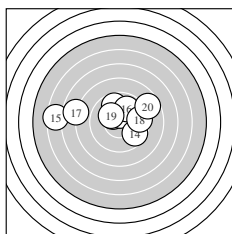

Serie 2:  
 10.4 \*                      10.5 \*                      9.7 ↗                      9.6 ↘                      6.4 ←  
 9.9 ↗                      7.8 ←                      9.5 →                      10.2 \*                      8.7 ↘  
 beste Teiler 117.4 (12.) 150.9 (11.) 189.0 (19.)  
 Trefferlage 1.00 mm links, 1.24 mm hoch  
 Streuwert 3.67, horizontal: 5.00, vertikal: 1.39

Unterschrift des Schützen

Ergebnis: **198.5** (190)  
 Serien: 98.2 100.3  
 Zähler: 11 8 1 0 0 0 0 0 0 0  
 Innenzehner: 6  
 weiteste: 505 (2), 419 (11), 413 (7)  
 beste Teiler 55.3 (5.) 105.3 (8.) 106.7 (20.)  
 Trefferlage 0.21 mm links, 0.37 mm tief  
 Streuwert 2.01, horizontal: 2.69, vertikal: 0.90

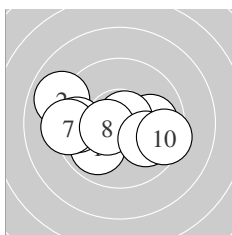
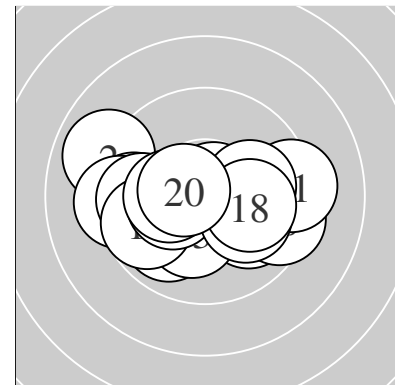

Serie 1:  
 9.9 ↙                      8.9 ↖                      9.9 ↘                      10.0 →                      10.7 \*  
 9.6 ←                      9.3 ←                      10.5 \*                      10.0 ↘                      9.4 →  
 beste Teiler 55.3 (5.) 105.3 (8.) 246.2 (9.)  
 Trefferlage 0.40 mm links, 0.36 mm tief  
 Streuwert 2.27, horizontal: 3.02, vertikal: 1.07

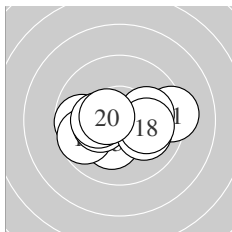

Serie 2:  
 9.3 →                      9.7 ←                      10.2 \*                      9.7 ↙                      10.1 →  
 10.3 \*                      10.1 ↘                      10.1 →                      10.3 \*                      10.5 \*  
 beste Teiler 106.7 (20.) 159.8 (16.) 172.0 (19.)  
 Trefferlage 0.03 mm links, 0.37 mm tief  
 Streuwert 1.82, horizontal: 2.46, vertikal: 0.75

Unterschrift des Schützen

Ergebnis: **136.1** (128)  
 Serien: 72.3 63.8  
 Zähler: 0 5 6 3 0 1 1 1 1 0  
 Innenzehner: 0  
 weiteste: 3584 (16), 3096 (10), 2010 (1)  
 beste Teiler 324.8 (9.) 367.9 (4.) 380.1 (18.)  
 Trefferlage 5.11 mm rechts, 2.73 mm tief  
 Streuwert 9.36, horizontal: 12.98, vertikal: 2.60

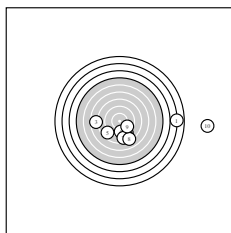
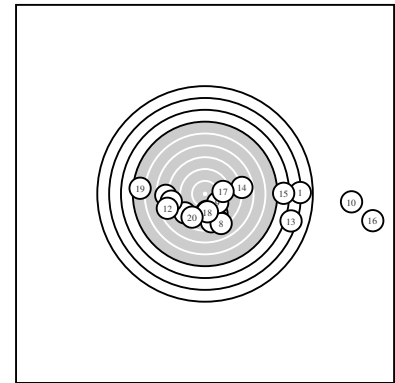

Serie 1:  
 2.9 →                      9.0 ↘                      7.6 ←                      9.5 ↓                      8.6 ↙  
 8.4 ↘                      8.5 ↓                      8.1 ↘                      9.7 ↘                      0.0 →  
 beste Teiler 324.8 (9.) 367.9 (4.) 483.2 (2.)  
 Trefferlage 5.16 mm rechts, 3.32 mm tief  
 Streuwert 8.38, horizontal: 11.62, vertikal: 2.35

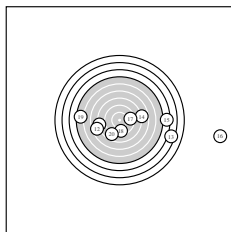

Serie 2:  
 8.0 ←                      7.5 ←                      3.3 →                      7.8 →                      4.3 →  
 0.0 →                      9.4 →                      9.4 ↓                      5.4 ←                      8.7 ↙  
 beste Teiler 380.1 (18.) 383.5 (17.) 561.8 (20.)  
 Trefferlage 5.06 mm rechts, 2.13 mm tief  
 Streuwert 10.69, horizontal: 14.86, vertikal: 2.83

Unterschrift des Schützen

Ergebnis: **202.7** (195)  
 Serien: 100.0 102.7  
 Zähler: 15 5 0 0 0 0 0 0 0 0  
 Innenzehner: 10  
 weiteste: 484 (5), 345 (10), 313 (16)  
 beste Teiler 60.7 (19.) 67.6 (18.) 90.0 (7.)  
 Trefferlage 0.33 mm links, 0.34 mm tief  
 Streuwert 1.61, horizontal: 1.90, vertikal: 1.26

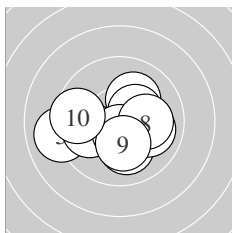
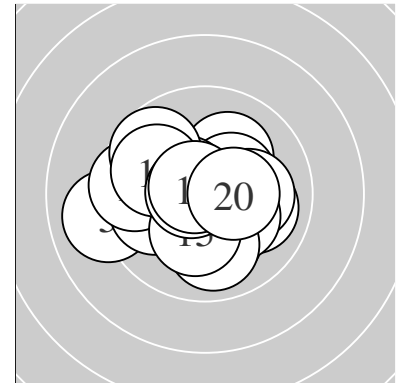

Serie 1:  
 10.1 ↓                      10.1 ↗                      10.4 \*                      10.0 →                      9.0 ←  
 9.9 ←                      10.6 \*                      10.1 →                      10.2 \*                      9.6 ←  
 beste Teiler 90.0 (7.) 146.9 (3.) 182.3 (9.)  
 Trefferlage 0.29 mm links, 0.44 mm tief  
 Streuwert 1.90, horizontal: 2.41, vertikal: 1.18

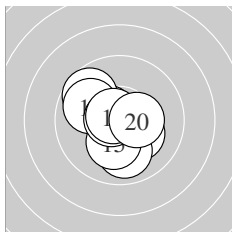

Serie 2:  
 10.4 \*                      10.2 \*                      10.5 \*                      10.0 ↓                      10.2 \*  
 9.7 ↘                      9.9 ↘                      10.7 \*                      10.7 \*                      10.4 \*  
 beste Teiler 60.7 (19.) 67.6 (18.) 113.5 (13.)  
 Trefferlage 0.36 mm links, 0.25 mm tief  
 Streuwert 1.37, horizontal: 1.35, vertikal: 1.39

Unterschrift des Schützen

Ergebnis: **200.5** (190)  
 Serien: 99.3 101.2  
 Zähler: 12 7 0 1 0 0 0 0 0 0  
 Innenzehner: 7  
 weiteste: 758 (3), 425 (2), 315 (16)  
 beste Teiler 45.0 (8.) 62.7 (20.) 76.5 (10.)  
 Trefferlage 0.11 mm rechts, 0.79 mm hoch  
 Streuwert 1.94, horizontal: 2.42, vertikal: 1.28

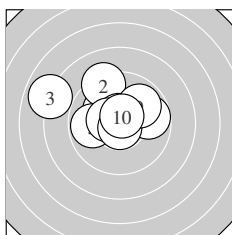
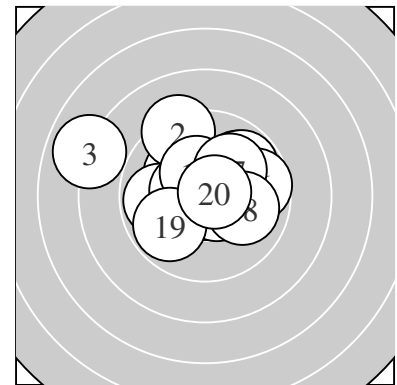

Serie 1:  
 10.1 ↘                      9.3 ↗                      7.9 ↖                      10.6 \*                      9.8 ←  
 10.5 \*                      9.8 →                      10.8 \*                      9.9 ↗                      10.6 \*  
 beste Teiler 45.0 (8.) 76.5 (10.) 79.4 (4.)  
 Trefferlage 0.90 mm links, 1.15 mm hoch  
 Streuwert 2.17, horizontal: 2.76, vertikal: 1.35

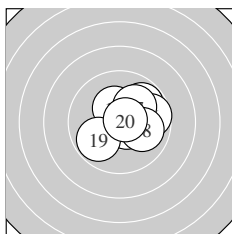

Serie 2:  
 10.1 →                      10.3 \*                      10.1 ↗                      10.6 \*                      9.8 ↗  
 9.7 →                      10.1 ↗                      10.0 →                      9.8 ↖                      10.7 \*  
 beste Teiler 62.7 (20.) 88.8 (14.) 152.5 (12.)  
 Trefferlage 1.14 mm rechts, 0.44 mm hoch  
 Streuwert 1.37, horizontal: 1.55, vertikal: 1.16

Unterschrift des Schützen

Ergebnis: **197.9** (188)  
 Serien: 98.4 99.5  
 Zähler: 11 7 1 1 0 0 0 0 0 0  
 Innenzehner: 11  
 weiteste: 847 (5), 599 (19), 494 (2)  
 beste Teiler 40.2 (7.) 56.0 (11.) 102.4 (12.)  
 Trefferlage 0.41 mm rechts, 0.48 mm hoch  
 Streuwert 2.35, horizontal: 3.14, vertikal: 1.08

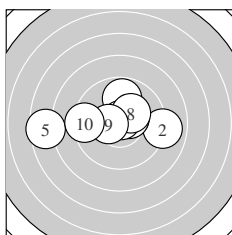
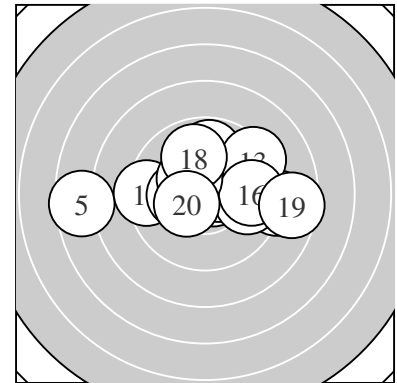

Serie 1:  
 10.3 \*                      9.0 →                      10.4 \*                      10.5 \*                      7.6 ←  
 9.8 ↑                      10.8 \*                      10.3 \*                      10.4 \*                      9.3 ←  
 beste Teiler 40.2 (7.) 120.4 (4.) 126.3 (9.)  
 Trefferlage 0.37 mm links, 0.53 mm hoch  
 Streuwert 2.65, horizontal: 3.61, vertikal: 1.03

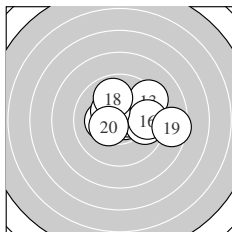

Serie 2:  
 10.7 \*                      10.5 \*                      9.3 ↗                      10.2 \*                      9.8 →  
 9.7 →                      10.4 \*                      9.9 ↑                      8.6 →                      10.4 \*  
 beste Teiler 56.0 (11.) 102.4 (12.) 143.1 (20.)  
 Trefferlage 1.20 mm rechts, 0.42 mm hoch  
 Streuwert 1.98, horizontal: 2.54, vertikal: 1.18

Unterschrift des Schützen



Ergebnis: **188.7** (179)  
 Serien: 94.8 93.9  
 Zähler: 6 8 5 1 0 0 0 0 0 0  
 Innenzehner: 5  
 weiteste: 830 (8), 722 (3), 602 (11)  
 beste Teiler 41.0 (9.) 73.3 (7.) 136.3 (4.)  
 Trefferlage 1.22 mm rechts, 1.12 mm tief  
 Streuwert 2.93, horizontal: 3.78, vertikal: 1.70

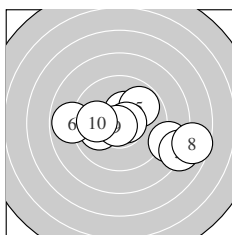
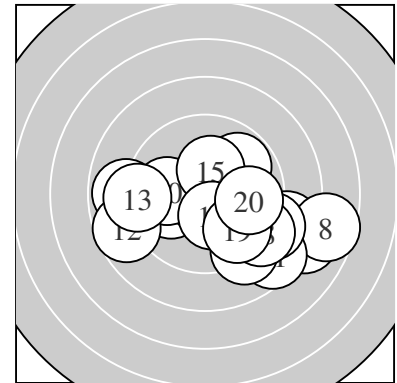

Serie 1:  
 10.0 ←                      8.6 →                      8.1 →                      10.4 \*                      9.8 ↗  
 8.9 ←                      10.7 \*                      7.6 →                      10.8 \*                      9.9 ←  
 beste Teiler 41.0 (9.) 73.3 (7.) 136.3 (4.)  
 Trefferlage 1.31 mm rechts, 0.49 mm tief  
 Streuwert 3.20, horizontal: 4.26, vertikal: 1.54

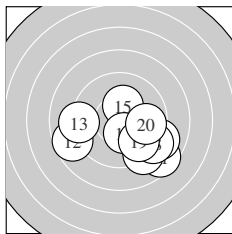

Serie 2:  
 8.5 ↘                      8.7 ←                      9.2 ←                      9.1 ↘                      10.3 \*  
 9.0 →                      10.4 \*                      9.2 ↘                      9.7 ↘                      9.8 →  
 beste Teiler 150.5 (17.) 164.2 (15.) 294.0 (20.)  
 Trefferlage 1.13 mm rechts, 1.75 mm tief  
 Streuwert 2.72, horizontal: 3.45, vertikal: 1.70

Unterschrift des Schützen

Ergebnis: **197.7** (189)  
 Serien: 99.4 98.3  
 Zähler: 11 7 2 0 0 0 0 0 0 0  
 Innenzehner: 9  
 weiteste: 725 (14), 572 (2), 500 (18)  
 beste Teiler 33.2 (11.) 53.9 (12.) 73.7 (3.)  
 Trefferlage 0.25 mm rechts, 0.69 mm hoch  
 Streuwert 2.26, horizontal: 2.74, vertikal: 1.63

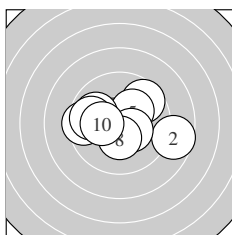
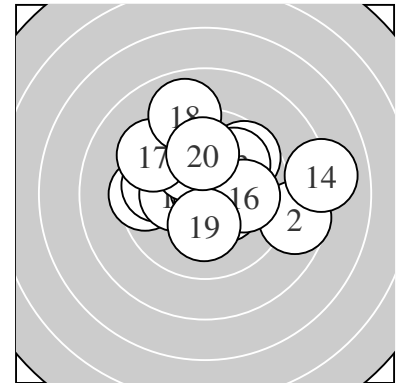

Serie 1:  
 9.6 ↗                      8.7 →                      10.7 \*                      9.5 ←                      10.2 \*  
 9.9 ↖                      10.4 \*                      10.4 \*                      9.8 ←                      10.2 \*  
 beste Teiler 73.7 (3.) 139.6 (7.) 150.0 (8.)  
 Trefferlage 0.10 mm links, 0.15 mm hoch  
 Streuwert 2.16, horizontal: 2.81, vertikal: 1.18

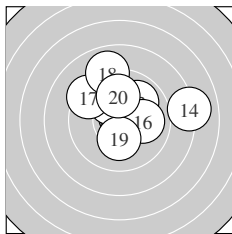

Serie 2:  
 10.8 \*                      10.7 \*                      9.9 ↗                      8.1 →                      10.2 \*  
 10.0 →                      9.4 ↖                      9.0 ↑                      10.2 \*                      10.0 ↑  
 beste Teiler 33.2 (11.) 53.9 (12.) 190.0 (19.)  
 Trefferlage 0.61 mm rechts, 1.23 mm hoch  
 Streuwert 2.37, horizontal: 2.77, vertikal: 1.88

Unterschrift des Schützen

Ergebnis: **195.9** (188)  
 Serien: 99.5 96.4  
 Zähler: 11 6 3 0 0 0 0 0 0 0  
 Innenzehner: 6  
 weiteste: 610 (17), 523 (7), 506 (12)  
 beste Teiler 97.0 (4.) 112.3 (15.) 124.3 (2.)  
 Trefferlage 0.24 mm rechts, 0.42 mm tief  
 Streuwert 2.35, horizontal: 3.13, vertikal: 1.11

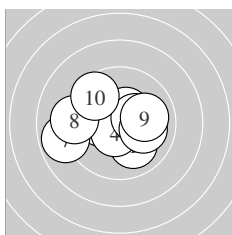
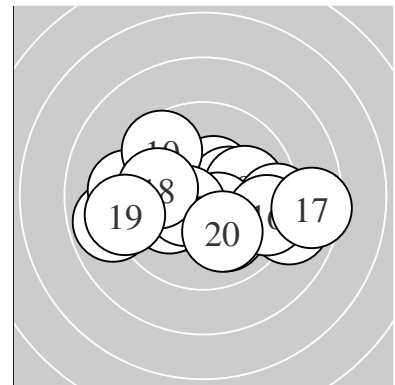

Serie 1:  
 10.0 ↘                      10.5 \*                      10.3 \*                      10.6 \*                      10.3 \*  
 10.0 →                      8.9 ←                      9.3 ←                      10.0 →                      9.6 ↖  
 beste Teiler 97.0 (4.) 124.3 (2.) 152.7 (5.)  
 Trefferlage 0.58 mm links, 0.02 mm hoch  
 Streuwert 2.07, horizontal: 2.63, vertikal: 1.30

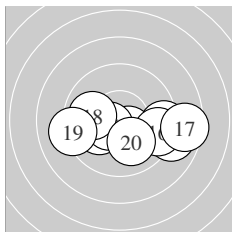

Serie 2:  
 9.3 →                      8.9 →                      10.1 ←                      10.5 \*                      10.5 \*  
 9.5 →                      8.5 →                      9.9 ←                      9.2 ←                      10.0 ↘  
 beste Teiler 112.3 (15.) 125.3 (14.) 211.5 (13.)  
 Trefferlage 1.07 mm rechts, 0.88 mm tief  
 Streuwert 2.52, horizontal: 3.50, vertikal: 0.65

Unterschrift des Schützen

Ergebnis: **202.4** (193)  
 Serien: 100.9 101.5  
 Zähler: 14 5 1 0 0 0 0 0 0 0  
 Innenzehner: 11  
 weiteste: 635 (18), 359 (15), 356 (3)  
 beste Teiler 51.5 (20.) 59.2 (16.) 78.5 (1.)  
 Trefferlage 0.07 mm links, 0.33 mm hoch  
 Streuwert 1.77, horizontal: 2.15, vertikal: 1.29

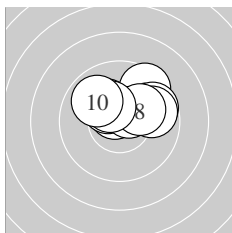
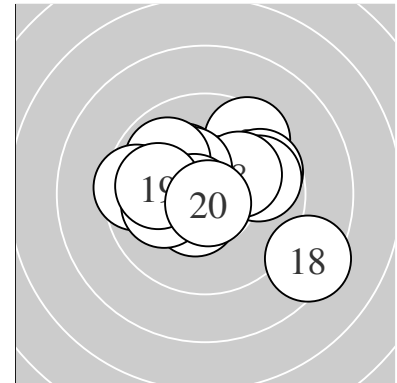

Serie 1:  
 10.6 \*                      10.2 \*                      9.5 ↗                      10.3 \*                      9.7 ↗  
 9.8 ↗                      10.5 \*                      10.1 ↗                      10.3 \*                      9.9 ↘  
 beste Teiler 78.5 (1.) 111.7 (7.) 151.7 (9.)  
 Trefferlage 0.50 mm rechts, 1.28 mm hoch  
 Streuwert 1.35, horizontal: 1.80, vertikal: 0.63

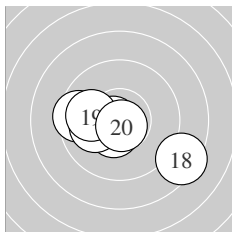

Serie 2:  
 10.5 \*                      10.6 \*                      10.5 \*                      10.5 \*                      9.5 ←  
 10.7 \*                      10.1 ←                      8.4 ↘                      10.0 ←                      10.7 \*  
 beste Teiler 51.5 (20.) 59.2 (16.) 84.0 (12.)  
 Trefferlage 0.66 mm links, 0.61 mm tief  
 Streuwert 1.85, horizontal: 2.39, vertikal: 1.06

Unterschrift des Schützen

Ergebnis: **189.4** (179)  
 Serien: 96.1 93.3  
 Zähler: 6 9 3 2 0 0 0 0 0 0  
 Innenzehner: 5  
 weiteste: 876 (17), 807 (2), 619 (12)  
 beste Teiler 52.1 (7.) 173.1 (10.) 178.0 (13.)  
 Trefferlage 1.66 mm rechts, 0.32 mm tief  
 Streuwert 2.86, horizontal: 3.80, vertikal: 1.37

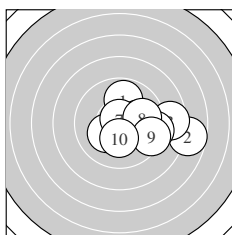
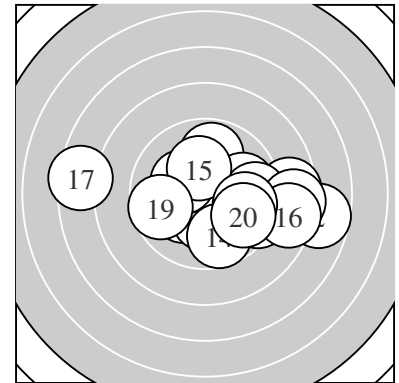

Serie 1:  
 9.9 ↑                      7.7 →                      8.6 →                      9.3 →                      10.2 \*  
 10.1 →                      10.7 \*                      9.9 →                      9.4 →                      10.3 \*  
 beste Teiler 52.1 (7.) 173.1 (10.) 191.0 (5.)  
 Trefferlage 2.51 mm rechts, 0.22 mm tief  
 Streuwert 2.31, horizontal: 2.95, vertikal: 1.40

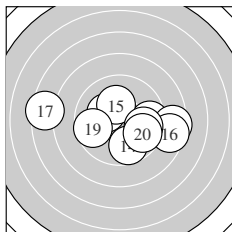

Serie 2:  
 9.6 →                      8.5 →                      10.2 \*                      9.7 ↓                      10.2 \*  
 8.5 →                      7.4 ←                      9.8 →                      9.7 ←                      9.7 →  
 beste Teiler 178.0 (13.) 183.8 (15.) 287.4 (18.)  
 Trefferlage 0.81 mm rechts, 0.43 mm tief  
 Streuwert 3.33, horizontal: 4.49, vertikal: 1.41

Unterschrift des Schützen

Ergebnis: **198.5** (190)  
 Serien: 99.3 99.2  
 Zähler: 11 8 1 0 0 0 0 0 0 0  
 Innenzehner: 8  
 weiteste: 589 (6), 487 (12), 412 (3)  
 beste Teiler 35.5 (4.) 104.5 (14.) 121.6 (8.)  
 Trefferlage 1.36 mm rechts, 0.09 mm tief  
 Streuwert 1.84, horizontal: 2.22, vertikal: 1.35

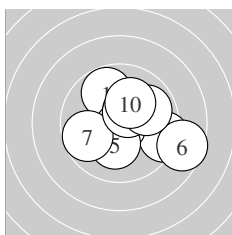
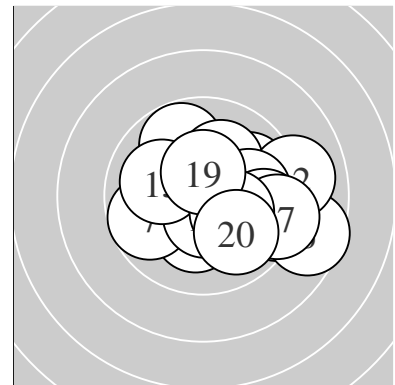

Serie 1:  
 9.8 ↖                      10.4 \*                      9.3 →                      10.8 \*                      10.2 \*  
 8.6 →                      9.7 ←                      10.5 \*                      9.9 ↗                      10.1 ↗  
 beste Teiler 35.5 (4.) 121.6 (8.) 133.1 (2.)  
 Trefferlage 0.99 mm rechts, 0.12 mm hoch  
 Streuwert 2.07, horizontal: 2.44, vertikal: 1.63

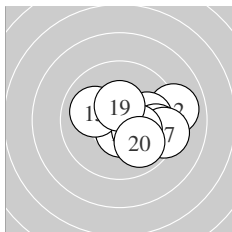

Serie 2:  
 10.2 \*                      9.0 →                      10.0 →                      10.5 \*                      10.0 ↖  
 9.6 →                      9.3 →                      10.3 \*                      10.4 \*                      9.9 ↘  
 beste Teiler 104.5 (14.) 126.0 (19.) 175.0 (18.)  
 Trefferlage 1.72 mm rechts, 0.30 mm tief  
 Streuwert 1.63, horizontal: 2.05, vertikal: 1.05

Unterschrift des Schützen

Ergebnis: **175.0** (167)  
 Serien: 86.9 88.1  
 Zähler: 2 7 7 4 0 0 0 0 0 0  
 Innenzehner: 2  
 weiteste: 986 (8), 925 (2), 828 (12)  
 beste Teiler 110.9 (11.) 138.0 (5.) 312.5 (6.)  
 Trefferlage 2.73 mm links, 0.58 mm hoch  
 Streuwert 3.81, horizontal: 5.13, vertikal: 1.63

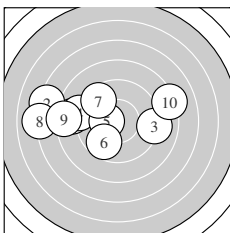
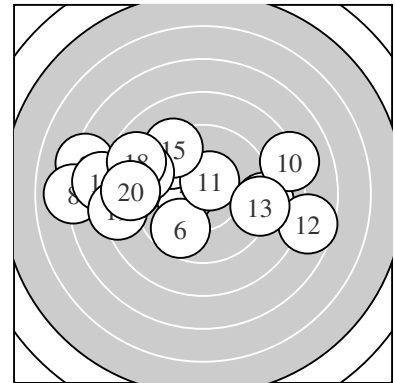

Serie 1:  
 8.6 ←                      7.3 ←                      9.1 →                      9.0 ←                      10.4 \*  
 9.7 ↙                      9.5 ↘                      7.0 ←                      8.2 ←                      8.1 →  
 beste Teiler 138.0 (5.) 312.5 (6.) 356.7 (7.)  
 Trefferlage 3.05 mm links, 0.61 mm hoch  
 Streuwert 3.99, horizontal: 5.41, vertikal: 1.61

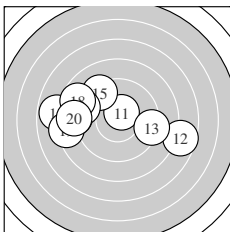

Serie 2:  
 10.5 \*                      7.6 →                      9.2 →                      8.8 ←                      9.3 ↘  
 7.9 ←                      9.1 ←                      8.7 ↘                      8.3 ←                      8.7 ←  
 beste Teiler 110.9 (11.) 415.4 (15.) 441.8 (13.)  
 Trefferlage 2.41 mm links, 0.56 mm hoch  
 Streuwert 3.82, horizontal: 5.12, vertikal: 1.74

Unterschrift des Schützen

Ergebnis: **202.7** (194)  
 Serien: 100.6 102.1  
 Zähler: 15 4 1 0 0 0 0 0 0 0  
 Innenzehner: 10  
 weiteste: 559 (19), 390 (3), 309 (10)  
 beste Teiler 34.1 (2.) 47.5 (12.) 77.8 (16.)  
 Trefferlage 1.23 mm links, 0.24 mm hoch  
 Streuwert 1.46, horizontal: 1.75, vertikal: 1.11

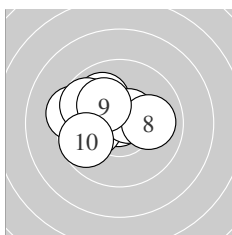
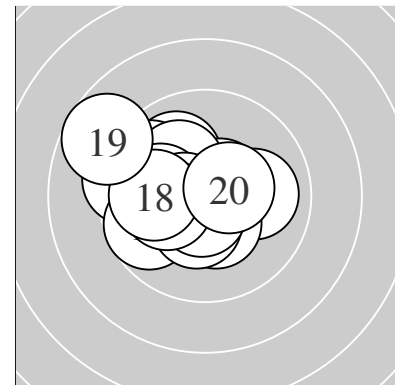

Serie 1:  
 10.0 ↘                      10.8 \*                      9.4 ←                      10.1 ↖                      10.1 ←  
 10.6 \*                      9.7 ↘                      10.0 →                      10.2 \*                      9.7 ←  
 beste Teiler 34.1 (2.) 94.6 (6.) 197.0 (9.)  
 Trefferlage 1.30 mm links, 0.55 mm hoch  
 Streuwert 1.48, horizontal: 1.84, vertikal: 0.99

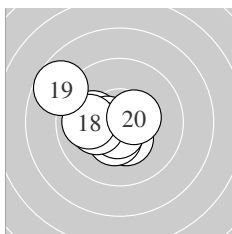

Serie 2:  
 10.1 ←                      10.8 \*                      10.5 \*                      10.4 \*                      10.4 \*  
 10.6 \*                      10.2 \*                      9.9 ←                      8.7 ↘                      10.5 \*  
 beste Teiler 47.5 (12.) 77.8 (16.) 102.5 (13.)  
 Trefferlage 1.17 mm links, 0.06 mm tief  
 Streuwert 1.49, horizontal: 1.75, vertikal: 1.18

Unterschrift des Schützen



Ergebnis: **185.6** (176)  
 Serien: 92.9 92.7 0.0  
 Zähler: 6 6 6 2 0 0 0 0 0 0  
 Innenzehner: 3  
 weiteste: 953 (7), 894 (15), 675 (10)  
 beste Teiler 29.4 (4.) 50.5 (6.) 156.5 (13.)  
 Trefferlage 1.63 mm links, 0.78 mm hoch  
 Streuwert 3.27, horizontal: 4.28, vertikal: 1.75

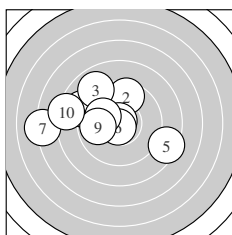
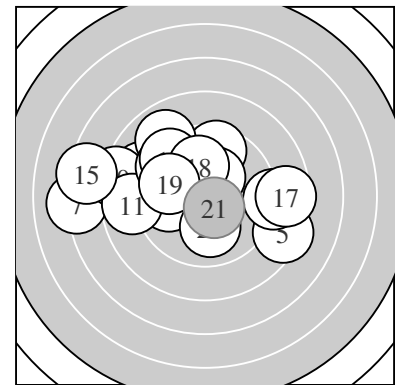

Serie 1:  
 9.0 ↘ 9.6 ↑ 8.9 ↘ 10.8 \* 8.4 ↘  
 10.8 \* 7.1 ← 10.1 ↖ 9.9 ← 8.3 ←  
 beste Teiler 29.4 (4.) 50.5 (6.) 223.2 (8.)  
 Trefferlage 2.21 mm links, 0.76 mm hoch  
 Streuwert 3.31, horizontal: 4.23, vertikal: 2.01

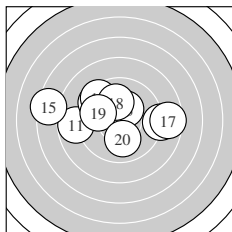

Serie 2:  
 8.8 ← 9.5 ↘ 10.3 \* 8.9 → 7.4 ←  
 9.4 ↘ 8.6 → 10.0 ↑ 9.8 ↖ 10.0 ↓  
 beste Teiler 156.5 (13.) 227.8 (18.) 232.1 (20.)  
 Trefferlage 1.06 mm links, 0.79 mm hoch  
 Streuwert 3.35, horizontal: 4.47, vertikal: 1.57

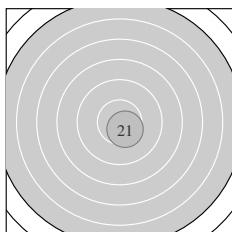

Serie 3:  
 0.0+ ↘  
AST, NSC  
 beste Teiler  
 Trefferlage 0.00 mm , 0.00 mm  
 Streuwert 0.00, horizontal: 0.00, vertikal: 0.00

AST – Treffer wurde nach Ende der Schießzeit abgegeben  
 NSC – Treffer wurde vermessen, geht aber nicht in die Wertung ein

Unterschrift des Schützen

Ergebnis: **185.1** (175)  
 Serien: 91.9 93.2  
 Zähler: 5 8 5 1 1 0 0 0 0 0  
 Innenzehner: 3  
 weiteste: 1034 (3), 970 (15), 602 (13)  
 beste Teiler 94.0 (11.) 138.4 (17.) 160.5 (19.)  
 Trefferlage 1.39 mm links, 1.99 mm hoch  
 Streuwert 3.08, horizontal: 3.97, vertikal: 1.81

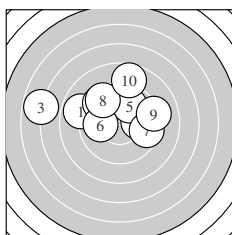
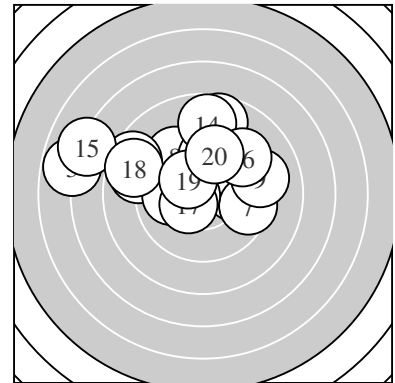

Serie 1:  
 8.9 ↙                      10.0 →                      6.8 ↙                      9.5 ↘                      9.9 ↗  
 10.0 ←                      9.5 →                      9.5 ↘                      9.1 →                      8.7 ↑  
 beste Teiler 242.4 (2.) 246.5 (6.) 261.5 (5.)  
 Trefferlage 0.94 mm links, 1.72 mm hoch  
 Streuwert 3.39, horizontal: 4.43, vertikal: 1.84

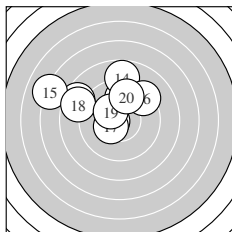

Serie 2:  
 10.6 \*                      9.8 ↑                      8.5 ↘                      8.8 ↑                      7.1 ↘  
 9.3 ↗                      10.4 \*                      8.7 ↘                      10.3 \*                      9.7 ↑  
 beste Teiler 94.0 (11.) 138.4 (17.) 160.5 (19.)  
 Trefferlage 1.84 mm links, 2.27 mm hoch  
 Streuwert 2.88, horizontal: 3.64, vertikal: 1.83

Unterschrift des Schützen

Ergebnis: **198.5** (189)  
 Serien: 97.6 100.9  
 Zähler: 13 3 4 0 0 0 0 0 0 0  
 Innenzehner: 12  
 weiteste: 632 (5), 579 (3), 534 (6)  
 beste Teiler 49.3 (9.) 106.9 (15.) 110.3 (16.)  
 Trefferlage 0.82 mm rechts, 0.59 mm hoch  
 Streuwert 2.10, horizontal: 2.83, vertikal: 0.91

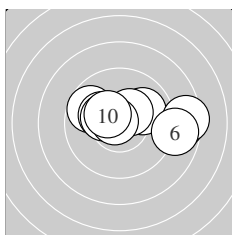
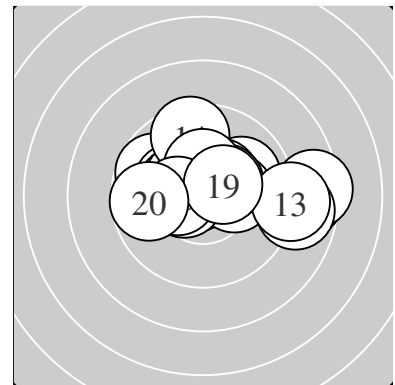

Serie 1:  
 9.7 ↖                      10.2 \*                      8.6 →                      10.0 ↗                      8.4 →  
 8.8 →                      10.3 \*                      10.4 \*                      10.8 \*                      10.4 \*  
 beste Teiler 49.3 (9.) 140.8 (8.) 142.2 (10.)  
 Trefferlage 1.29 mm rechts, 0.52 mm hoch  
 Streuwert 2.45, horizontal: 3.41, vertikal: 0.65

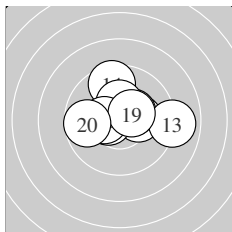

Serie 2:  
 10.2 \*                      10.4 \*                      8.9 →                      9.6 ↑                      10.5 \*  
 10.5 \*                      10.3 \*                      10.4 \*                      10.4 \*                      9.7 ←  
 beste Teiler 106.9 (15.) 110.3 (16.) 131.2 (19.)  
 Trefferlage 0.35 mm rechts, 0.65 mm hoch  
 Streuwert 1.76, horizontal: 2.20, vertikal: 1.14

Unterschrift des Schützen

Ergebnis: **186.7** (176)  
 Serien: 92.2 94.5  
 Zähler: 5 9 3 3 0 0 0 0 0 0  
 Innenzehner: 3  
 weiteste: 812 (15), 804 (9), 751 (16)  
 beste Teiler 51.0 (18.) 57.8 (19.) 59.6 (12.)  
 Trefferlage 1.84 mm links, 1.13 mm hoch  
 Streuwert 3.03, horizontal: 3.90, vertikal: 1.77

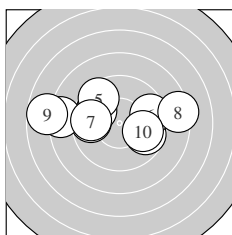
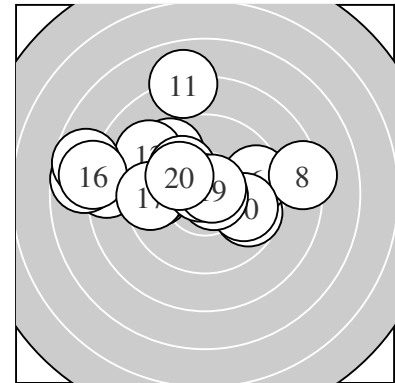

Serie 1:  
 9.7 ↘                      9.7 ←                      9.8 ↖                      8.3 ←                      9.5 ↖  
 9.6 →                      9.7 ←                      8.3 →                      7.7 ←                      9.9 →

beste Teiler 270.3 (10.) 289.8 (3.) 310.9 (1.)  
 Trefferlage 1.03 mm links, 0.63 mm hoch  
 Streuwert 3.38, horizontal: 4.65, vertikal: 1.14

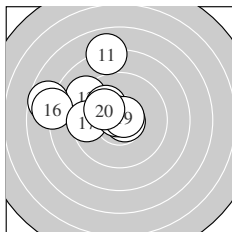

Serie 2:  
 8.0 ↑                      10.7 \*                      9.1 ↖                      10.1 ↖                      7.7 ←  
 7.9 ←                      9.5 ←                      10.7 \*                      10.7 \*                      10.1 ↖

beste Teiler 51.0 (18.) 57.8 (19.) 59.6 (12.)  
 Trefferlage 2.64 mm links, 1.64 mm hoch  
 Streuwert 2.62, horizontal: 3.00, vertikal: 2.17

Unterschrift des Schützen

Ergebnis: **208.2** (198)  
 Serien: 104.0 104.2  
 Zähler: 18 2 0 0 0 0 0 0 0 0  
 Innenzehner: 17  
 weiteste: 256 (1), 252 (3), 238 (12)  
 beste Teiler 34.1 (9.) 44.5 (19.) 52.6 (5.)  
 Trefferlage 0.06 mm rechts, 0.11 mm hoch  
 Streuwert 1.09, horizontal: 1.13, vertikal: 1.06

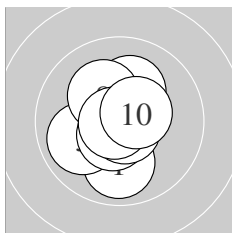
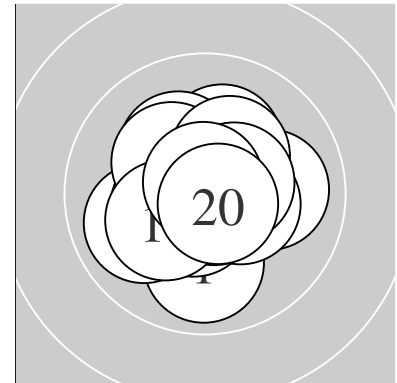

Serie 1:  
 9.9 ↓                      10.5 \*                      9.9 ↙                      10.6 \*                      10.7 \*  
 10.2 \*                      10.7 \*                      10.2 \*                      10.8 \*                      10.5 \*  
 beste Teiler 34.1 (9.) 52.6 (5.) 70.7 (7.)  
 Trefferlage 0.17 mm links, 0.04 mm hoch  
 Streuwert 1.16, horizontal: 0.95, vertikal: 1.34

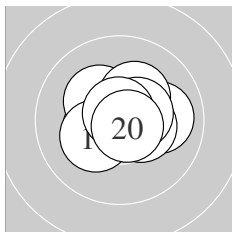

Serie 2:  
 10.4 \*                      10.0 →                      10.4 \*                      10.3 \*                      10.6 \*  
 10.3 \*                      10.5 \*                      10.2 \*                      10.8 \*                      10.7 \*  
 beste Teiler 44.5 (19.) 60.6 (20.) 98.8 (15.)  
 Trefferlage 0.29 mm rechts, 0.18 mm hoch  
 Streuwert 1.05, horizontal: 1.29, vertikal: 0.75

Unterschrift des Schützen

Ergebnis: **193.3** (184)  
 Serien: 95.4 97.9  
 Zähler: 6 12 2 0 0 0 0 0 0 0  
 Innenzehner: 5  
 weiteste: 691 (11), 541 (13), 499 (5)  
 beste Teiler 18.8 (16.) 80.1 (6.) 96.9 (12.)  
 Trefferlage 1.32 mm links, 0.25 mm tief  
 Streuwert 2.44, horizontal: 2.98, vertikal: 1.74

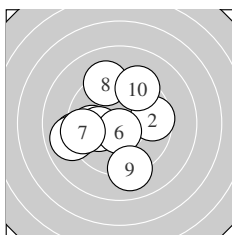
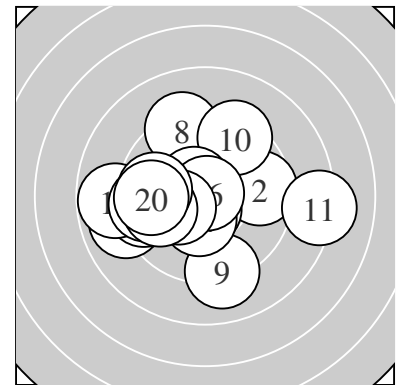

Serie 1:  
 9.8 ←                      9.6 →                      9.1 ←                      10.1 ←                      9.0 ←  
 10.6 \*                      9.4 ←                      9.3 ↗                      9.1 ↓                      9.4 ↗  
 beste Teiler 80.1 (6.) 216.2 (4.) 281.7 (1.)  
 Trefferlage 1.30 mm links, 0.19 mm tief  
 Streuwert 2.60, horizontal: 2.74, vertikal: 2.45

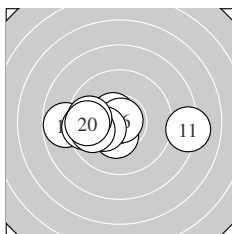

Serie 2:  
 8.2 →                      10.6 \*                      8.8 ←                      10.4 \*                      9.5 ←  
 10.9 \*                      10.3 \*                      9.8 ←                      9.7 ←                      9.7 ←  
 beste Teiler 18.8 (16.) 96.9 (12.) 142.3 (14.)  
 Trefferlage 1.35 mm links, 0.32 mm tief  
 Streuwert 2.41, horizontal: 3.35, vertikal: 0.62

Unterschrift des Schützen

Ergebnis: **182.2** (173)  
 Serien: 91.0 91.2  
 Zähler: 2 11 5 2 0 0 0 0 0 0  
 Innenzehner: 2  
 weiteste: 916 (13), 864 (7), 716 (5)  
 beste Teiler 143.4 (9.) 176.1 (16.) 254.7 (11.)  
 Trefferlage 0.75 mm links, 0.55 mm tief  
 Streuwert 3.57, horizontal: 4.66, vertikal: 1.94

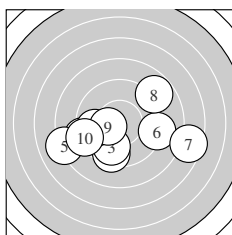
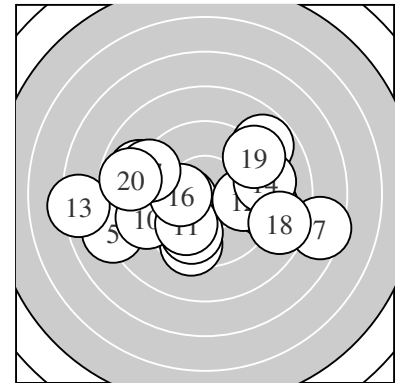

Serie 1:  
 9.1 ←                      9.4 ↓                      9.8 ↓                      9.7 ←                      8.1 ←  
 9.1 →                      7.5 →                      8.8 ↗                      10.4 \*                      9.1 ←  
 beste Teiler 143.4 (9.) 295.3 (3.) 303.7 (4.)  
 Trefferlage 0.46 mm links, 1.33 mm tief  
 Streuwert 3.60, horizontal: 4.69, vertikal: 1.99

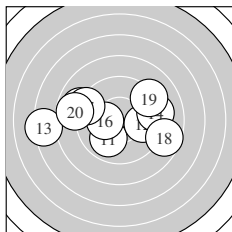

Serie 2:  
 9.9 ↓                      9.8 →                      7.3 ←                      9.2 →                      8.9 ↖  
 10.2 \*                      9.2 ↖                      8.7 →                      9.2 ↗                      8.8 ←  
 beste Teiler 176.1 (16.) 254.7 (11.) 281.1 (12.)  
 Trefferlage 1.03 mm links, 0.23 mm hoch  
 Streuwert 3.62, horizontal: 4.86, vertikal: 1.63

Unterschrift des Schützen

Ergebnis: **186.8** (179)  
 Serien: 93.6 93.2  
 Zähler: 8 5 5 2 0 0 0 0 0 0  
 Innenzehner: 6  
 weiteste: 871 (20), 843 (9), 741 (16)  
 beste Teiler 65.3 (2.) 108.3 (12.) 114.3 (1.)  
 Trefferlage 1.13 mm links, 0.14 mm hoch  
 Streuwert 3.38, horizontal: 4.24, vertikal: 2.21

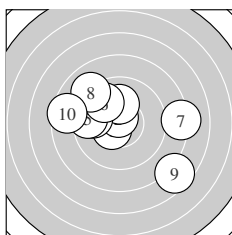
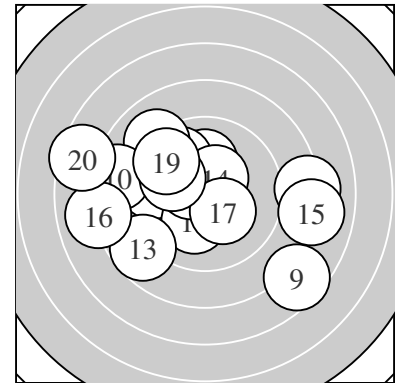

Serie 1:  
 10.5 \*                      10.7 \*                      10.1 ↑                      9.7 ←                      9.5 ←  
 9.8 ↘                      8.2 →                      9.0 ↘                      7.6 ↘                      8.5 ←  
 beste Teiler 65.3 (2.) 114.3 (1.) 215.0 (3.)  
 Trefferlage 0.54 mm links, 0.47 mm hoch  
 Streuwert 3.43, horizontal: 4.17, vertikal: 2.48

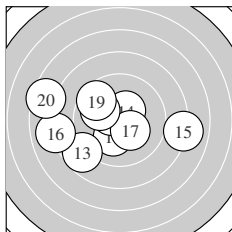

Serie 2:  
 10.2 \*                      10.5 \*                      8.7 ↙                      10.4 \*                      8.0 →  
 8.0 ←                      10.3 \*                      10.0 ↘                      9.6 ↘                      7.5 ←  
 beste Teiler 108.3 (12.) 127.8 (14.) 168.3 (17.)  
 Trefferlage 1.72 mm links, 0.19 mm tief  
 Streuwert 3.44, horizontal: 4.45, vertikal: 1.97

Unterschrift des Schützen



Ergebnis: **201.0** (191)  
 Serien: 100.9 100.1  
 Zähler: 11 9 0 0 0 0 0 0 0 0  
 Innenzehner: 8  
 weiteste: 407 (18), 384 (17), 356 (1)  
 beste Teiler 29.2 (6.) 63.6 (19.) 102.4 (9.)  
 Trefferlage 0.12 mm rechts, 0.15 mm tief  
 Streuwert 1.78, horizontal: 2.10, vertikal: 1.39

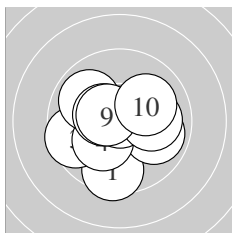
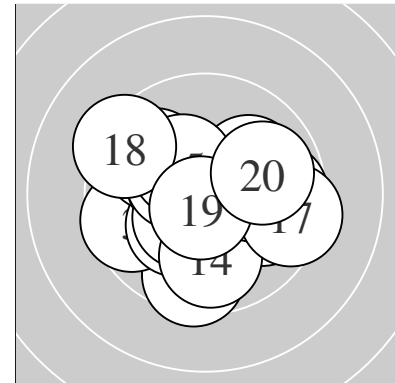

Serie 1:  
 9.5 ↓                      9.9 →                      9.6 ←                      10.2 \*                      9.9 ↖  
 10.8 \*                      10.4 \*                      10.0 →                      10.5 \*                      10.1 ↗  
 beste Teiler 29.2 (6.) 102.4 (9.) 126.0 (7.)  
 Trefferlage 0.24 mm links, 0.29 mm tief  
 Streuwert 1.72, horizontal: 1.93, vertikal: 1.48

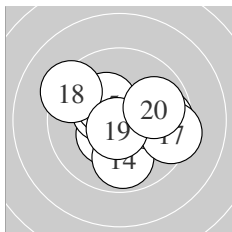

Serie 2:  
 9.7 →                      10.4 \*                      10.4 \*                      9.9 ↓                      10.3 \*  
 10.1 →                      9.4 →                      9.3 ↖                      10.7 \*                      9.9 →  
 beste Teiler 63.6 (19.) 137.3 (12.) 140.0 (13.)  
 Trefferlage 0.49 mm rechts, 0.02 mm tief  
 Streuwert 1.89, horizontal: 2.31, vertikal: 1.36

Unterschrift des Schützen

Ergebnis: **156.9** (147)  
 Serien: 82.7 74.2  
 Zähler: 0 7 2 5 3 3 0 0 0 0  
 Innenzehner: 0  
 weiteste: 1437 (16), 1364 (9), 1291 (18)  
 beste Teiler 281.7 (11.) 282.9 (13.) 308.9 (8.)  
 Trefferlage 3.63 mm rechts, 0.99 mm tief  
 Streuwert 5.62, horizontal: 7.61, vertikal: 2.30

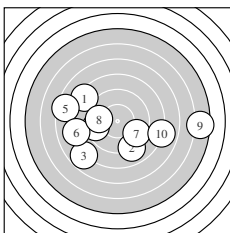
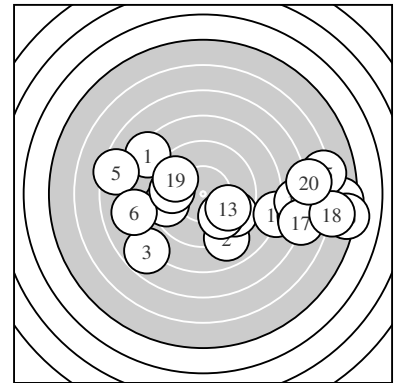

Serie 1:  
 8.3 ↘                      9.0 ↘                      7.8 ↙                      9.5 ←                      7.4 ←  
 8.1 ←                      9.5 ↘                      9.7 ←                      5.5 →                      7.9 →  
 beste Teiler 308.9 (8.) 368.9 (7.) 374.7 (4.)  
 Trefferlage 0.68 mm links, 1.09 mm tief  
 Streuwert 5.39, horizontal: 7.09, vertikal: 2.81

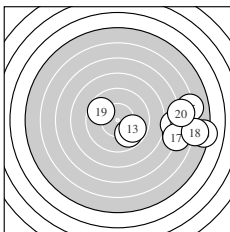

Serie 2:  
 9.8 ↘                      7.0 →                      9.8 ↘                      7.2 →                      6.1 →  
 5.2 →                      6.9 →                      5.8 →                      9.7 ↖                      6.7 →  
 beste Teiler 281.7 (11.) 282.9 (13.) 310.5 (19.)  
 Trefferlage 7.94 mm rechts, 0.90 mm tief  
 Streuwert 4.11, horizontal: 5.52, vertikal: 1.81

Unterschrift des Schützen

Ergebnis: **174.2** (168)  
 Serien: 85.6 88.6  
 Zähler: 4 7 5 3 0 0 1 0 0 0  
 Innenzehner: 0  
 weiteste: 1671 (3), 941 (17), 907 (4)  
 beste Teiler 203.8 (10.) 219.7 (1.) 220.0 (9.)  
 Trefferlage 3.17 mm links, 2.85 mm hoch  
 Streuwert 3.59, horizontal: 4.67, vertikal: 2.00

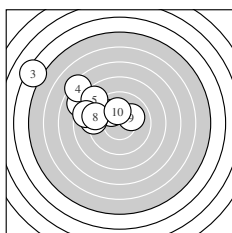
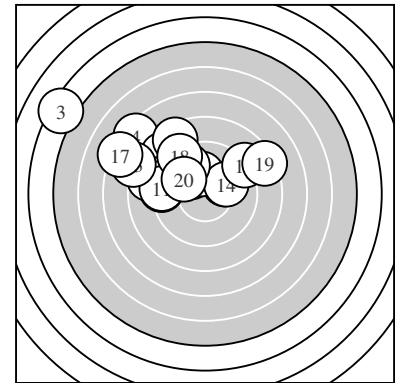

Serie 1:  
 10.1 ↘                      8.0 ↘                      4.3 ↘                      7.3 ↘                      8.6 ↘  
 9.2 ←                      8.6 ←                      9.3 ←                      10.1 →                      10.1 ↑  
 beste Teiler 203.8 (10.) 219.7 (1.) 220.0 (9.)  
 Trefferlage 4.60 mm links, 2.92 mm hoch  
 Streuwert 3.63, horizontal: 4.48, vertikal: 2.50

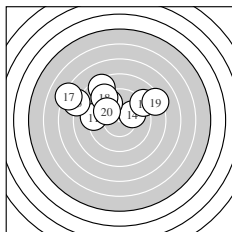

Serie 2:  
 9.2 ←                      8.5 ↘                      7.8 ↘                      10.0 →                      9.0 ↗  
 9.6 ↘                      7.2 ↘                      9.1 ↘                      8.3 →                      9.9 ↘  
 beste Teiler 234.4 (14.) 258.5 (20.) 335.4 (16.)  
 Trefferlage 1.74 mm links, 2.79 mm hoch  
 Streuwert 3.43, horizontal: 4.63, vertikal: 1.47

Unterschrift des Schützen