

Ergebnis: **198.4** (191)
 Serien: 101.7 96.7
 Zaehler: 12 7 1 0 0 0 0 0 0 0
 Innenzehner: 8
 weiteste: 659 (11), 471 (4), 461 (20)
 beste Teiler 27.8 (1.) 64.5 (3.) 93.1 (15.)
 Trefferlage 0.56 mm links, 0.42 mm tief
 Streuwert 2.12, horizontal: 2.48, vertikal: 1.68

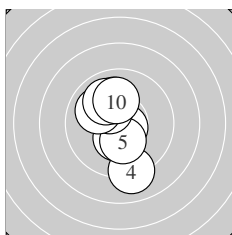

Serie 1:
 10.8 * 10.4 * 10.7 * 9.1 ↓ 10.3 *
 10.3 * 10.0 ↖ 10.0 ↑ 10.0 ↗ 10.1 ↑
 beste Teiler 27.8 (1.) 64.5 (3.) 144.8 (2.)
 Trefferlage 0.38 mm links, 0.10 mm hoch
 Streuwert 1.67, horizontal: 0.92, vertikal: 2.18

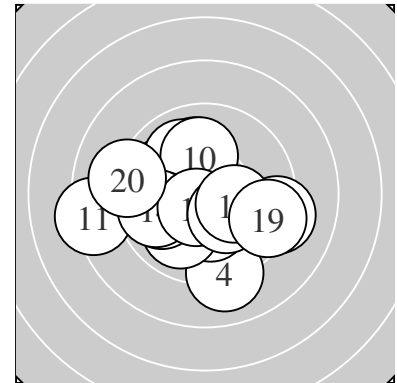
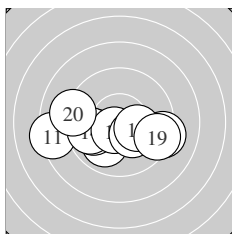

Serie 2:
 8.3 ← 9.9 ↙ 9.9 ← 9.8 ← 10.6 *
 9.2 → 10.3 * 10.2 * 9.4 → 9.1 ←
 beste Teiler 93.1 (15.) 171.1 (17.) 179.6 (18.)
 Trefferlage 0.75 mm links, 0.94 mm tief
 Streuwert 2.51, horizontal: 3.47, vertikal: 0.77

Unterschrift des Schuetzen

Ergebnis: **174.9** (164)
 Serien: 87.7 87.2
 Zaehler: 3 7 4 4 1 1 0 0 0 0
 Innenzehner: 3
 weiteste: 1262 (3), 1035 (7), 976 (14)
 beste Teiler 106.1 (2.) 149.8 (4.) 167.5 (6.)
 Trefferlage 3.14 mm links, 1.46 mm hoch
 Streuwert 3.83, horizontal: 5.03, vertikal: 2.01

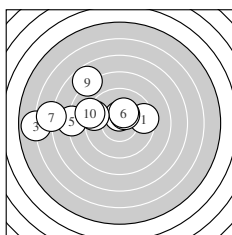
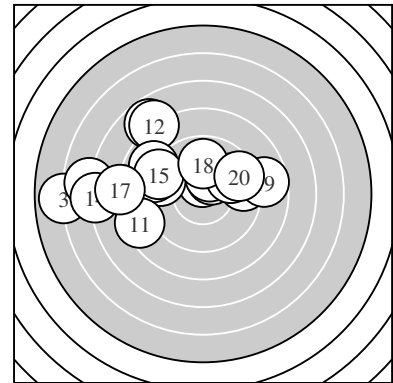

Serie 1:
 9.5 → 10.5 * 5.9 ← 10.4 * 8.1 ←
 10.3 * 6.8 ← 9.3 ← 7.8 ↖ 9.1 ←
 beste Teiler 106.1 (2.) 149.8 (4.) 167.5 (6.)
 Trefferlage 3.83 mm links, 1.45 mm hoch
 Streuwert 3.90, horizontal: 5.20, vertikal: 1.81

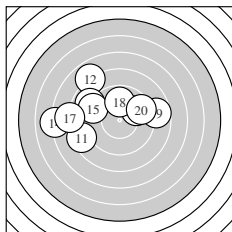

Serie 2:
 8.4 ← 7.9 ↖ 8.9 ↖ 7.0 ← 9.2 ↖
 9.8 ↗ 7.9 ← 9.9 ↑ 8.7 → 9.5 →
 beste Teiler 274.0 (18.) 288.3 (16.) 364.4 (20.)
 Trefferlage 2.46 mm links, 1.48 mm hoch
 Streuwert 3.90, horizontal: 5.03, vertikal: 2.28

Unterschrift des Schuetzen

Ergebnis: **194.3** (183)
 Serien: 97.7 96.6
 Zaehler: 4 15 1 0 0 0 0 0 0 0
 Innenzehner: 4
 weiteste: 509 (20), 441 (13), 417 (11)
 beste Teiler 79.6 (10.) 112.2 (16.) 146.4 (14.)
 Trefferlage 0.23 mm links, 0.39 mm tief
 Streuwert 2.37, horizontal: 3.06, vertikal: 1.39

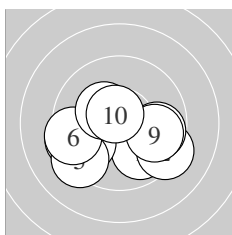
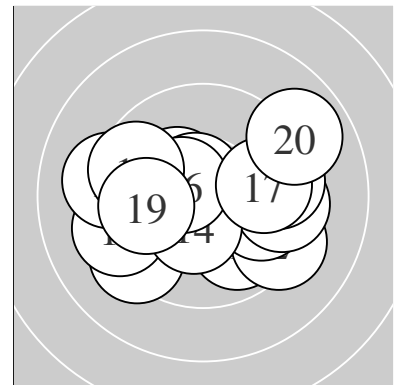

Serie 1:
 9.9 ↘ 9.3 ↘ 9.8 ↙ 9.4 ↙ 9.3 ↙
 9.5 ← 9.8 → 10.3 * 9.8 → 10.6 *
 beste Teiler 79.6 (10.) 155.7 (8.) 268.0 (1.)
 Trefferlage 0.36 mm links, 1.06 mm tief
 Streuwert 2.19, horizontal: 2.85, vertikal: 1.21

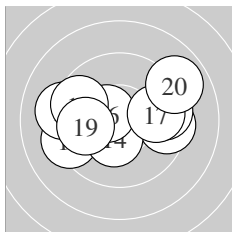

Serie 2:
 9.3 ↙ 9.5 → 9.2 ↙ 10.4 * 9.5 →
 10.5 * 9.8 → 9.6 ↙ 9.9 ← 8.9 ↗
 beste Teiler 112.2 (16.) 146.4 (14.) 270.1 (19.)
 Trefferlage 0.11 mm links, 0.26 mm hoch
 Streuwert 2.57, horizontal: 3.40, vertikal: 1.27

Unterschrift des Schuetzen

Ergebnis: **201.2** (193)
 Serien: 99.9 101.3
 Zaehler: 13 7 0 0 0 0 0 0 0 0
 Innenzehner: 8
 weiteste: 364 (18), 325 (20), 312 (1)
 beste Teiler 65.6 (19.) 96.6 (15.) 149.4 (3.)
 Trefferlage 0.36 mm rechts, 0.76 mm hoch
 Streuwert 1.61, horizontal: 1.76, vertikal: 1.44

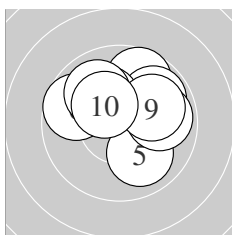
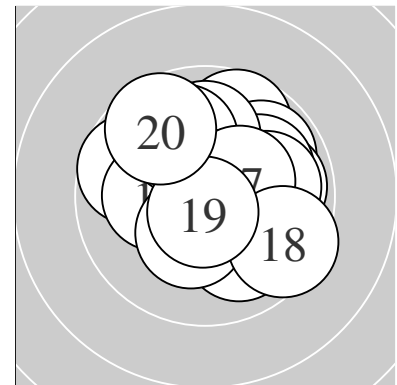

Serie 1:
 9.7 ↗ 9.8 ↗ 10.4 * 10.2 * 10.0 ↘
 9.7 ↖ 9.9 ↖ 9.9 → 10.0 → 10.3 *
 beste Teiler 149.4 (3.) 159.9 (10.) 184.4 (4.)
 Trefferlage 0.48 mm rechts, 1.04 mm hoch
 Streuwert 1.63, horizontal: 1.91, vertikal: 1.29

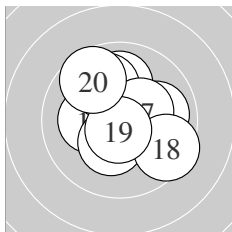

Serie 2:
 10.0 → 10.0 ↑ 10.2 * 10.0 ↖ 10.6 *
 10.3 * 10.3 * 9.5 ↘ 10.7 * 9.7 ↖
 beste Teiler 65.6 (19.) 96.6 (15.) 151.9 (17.)
 Trefferlage 0.25 mm rechts, 0.48 mm hoch
 Streuwert 1.64, horizontal: 1.70, vertikal: 1.59

Unterschrift des Schuetzen

Ergebnis: **0.0** (0)_{DNS}

Serien:

Zaehler: 0 0 0 0 0 0 0 0 0 0

Innenzehner: 0

weiteste:

beste Teiler – Schütze ist nicht zum Wettkampf angetreten

Trefferlage 0.00 mm , 0.00 mm

Streuwert

Unterschrift des Schuetzen

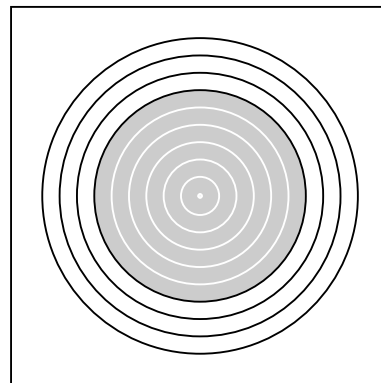

Ergebnis: **195.8** (184)
 Serien: 100.8 95.0
 Zaehler: 9 6 5 0 0 0 0 0 0 0
 Innenzehner: 8
 weiteste: 713 (11), 668 (19), 598 (14)
 beste Teiler 10.0 (16.) 15.8 (10.) 56.8 (6.)
 Trefferlage 0.37 mm rechts, 0.94 mm tief
 Streuwert 2.55, horizontal: 3.37, vertikal: 1.31

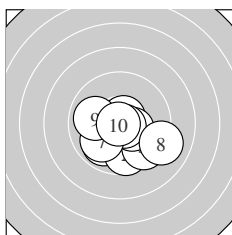
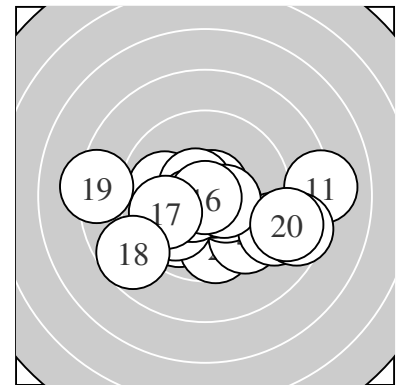

Serie 1:
 9.9 ↙ 9.7 ↓ 10.7 * 9.5 ↘ 10.4 *
 10.7 * 10.0 ↙ 9.1 ↘ 9.9 ← 10.9 *
 beste Teiler 15.8 (10.) 56.8 (6.) 69.6 (3.)
 Trefferlage 0.35 mm rechts, 1.14 mm tief
 Streuwert 1.72, horizontal: 2.04, vertikal: 1.31

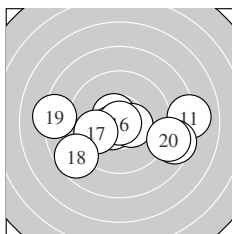

Serie 2:
 8.1 → 10.6 * 10.6 * 8.6 → 10.5 *
 10.9 * 9.9 ← 8.7 ↙ 8.3 ← 8.8 →
 beste Teiler 10.0 (16.) 89.2 (12.) 97.2 (13.)
 Trefferlage 0.40 mm rechts, 0.74 mm tief
 Streuwert 3.29, horizontal: 4.45, vertikal: 1.34

Unterschrift des Schuetzen

Ergebnis: **204.4** (193)
 Serien: 103.4 101.0
 Zaehler: 14 5 1 0 0 0 0 0 0 0
 Innenzehner: 13
 weiteste: 576 (13), 296 (15), 280 (10)
 beste Teiler 27.4 (17.) 71.3 (2.) 80.6 (4.)
 Trefferlage 0.57 mm links, 0.02 mm tief
 Streuwert 1.52, horizontal: 1.99, vertikal: 0.81

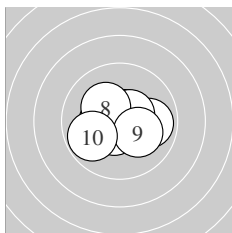
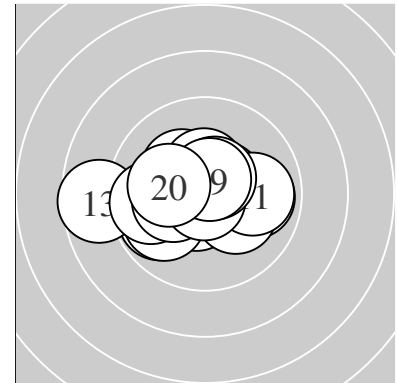

Serie 1:
 9.9 → 10.7 * 10.4 * 10.6 * 10.5 *
 10.6 * 10.5 * 10.2 * 10.2 * 9.8 ←
 beste Teiler 71.3 (2.) 80.6 (4.) 96.2 (6.)
 Trefferlage 0.02 mm links, 0.10 mm tief
 Streuwert 1.25, horizontal: 1.54, vertikal: 0.86

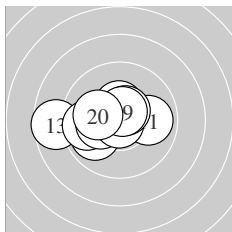

Serie 2:
 9.9 → 10.4 * 8.6 ← 9.9 ← 9.8 ←
 10.3 * 10.8 * 10.6 * 10.6 * 10.1 ←
 beste Teiler 27.4 (17.) 81.9 (19.) 100.4 (18.)
 Trefferlage 1.13 mm links, 0.05 mm hoch
 Streuwert 1.72, horizontal: 2.30, vertikal: 0.80

Unterschrift des Schuetzen

Ergebnis: **181.8** (174)
 Serien: 91.2 90.6
 Zaehler: 7 7 3 0 2 1 0 0 0 0
 Innenzehner: 7
 weiteste: 1309 (7), 1194 (19), 1043 (17)
 beste Teiler 90.2 (15.) 104.3 (20.) 129.4 (18.)
 Trefferlage 0.18 mm links, 0.16 mm hoch
 Streuwert 4.24, horizontal: 5.92, vertikal: 0.92

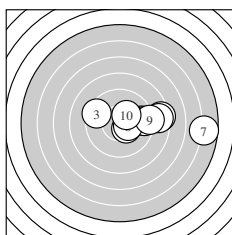
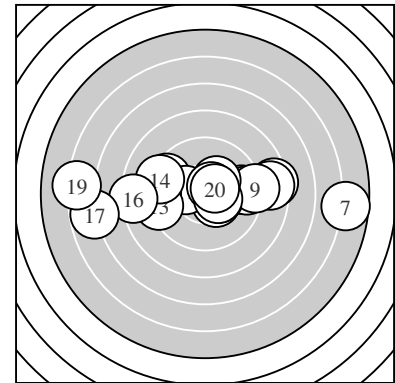

Serie 1:
 9.6 → 10.4 * 9.4 ↖ 8.4 → 9.4 →
 8.5 → 5.7 → 10.4 * 9.1 → 10.3 *
 beste Teiler 130.8 (2.) 137.5 (8.) 164.0 (10.)
 Trefferlage 3.72 mm rechts, 0.34 mm hoch
 Streuwert 3.17, horizontal: 4.39, vertikal: 0.88

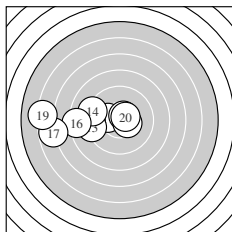

Serie 2:
 10.2 * 9.2 ← 9.2 ← 9.2 ↖ 10.6 *
 8.3 ← 6.8 ← 10.4 * 6.2 ← 10.5 *
 beste Teiler 90.2 (15.) 104.3 (20.) 129.4 (18.)
 Trefferlage 4.09 mm links, 0.01 mm tief
 Streuwert 3.29, horizontal: 4.55, vertikal: 0.98

Unterschrift des Schuetzen

Ergebnis: **199.3** (192)
 Serien: 100.7 98.6
 Zaehler: 14 4 2 0 0 0 0 0 0 0
 Innenzehner: 9
 weiteste: 715 (16), 642 (11), 387 (4)
 beste Teiler 56.2 (10.) 74.3 (20.) 76.1 (17.)
 Trefferlage 0.49 mm links, 0.40 mm tief
 Streuwert 2.15, horizontal: 2.84, vertikal: 1.07

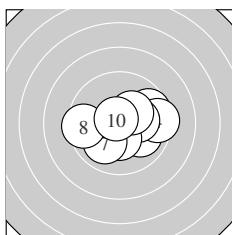
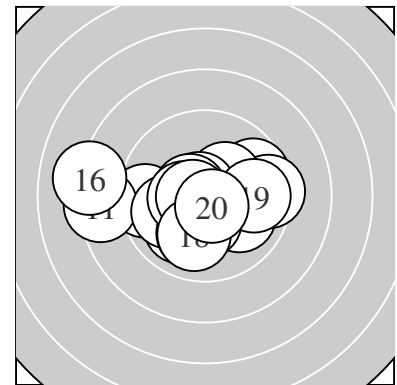

Serie 1:
 10.6 * 9.7 → 10.0 ↘ 9.4 → 10.2 *
 10.3 * 10.0 ↙ 9.5 ← 10.3 * 10.7 *
 beste Teiler 56.2 (10.) 95.7 (1.) 155.0 (6.)
 Trefferlage 0.68 mm rechts, 0.25 mm tief
 Streuwert 1.75, horizontal: 2.22, vertikal: 1.09

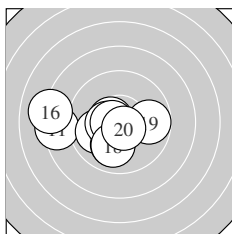

Serie 2:
 8.4 ← 10.0 ← 10.6 * 10.0 ↓ 10.4 *
 8.1 ← 10.6 * 10.0 ↓ 9.8 → 10.7 *
 beste Teiler 74.3 (20.) 76.1 (17.) 97.4 (13.)
 Trefferlage 1.67 mm links, 0.55 mm tief
 Streuwert 2.26, horizontal: 3.01, vertikal: 1.09

Unterschrift des Schuetzen

Ergebnis: **181.6** (172)
 Serien: 92.3 89.3
 Zaehler: 4 8 6 1 0 1 0 0 0 0
 Innenzehner: 2
 weiteste: 1303 (10), 888 (13), 738 (11)
 beste Teiler 152.4 (1.) 197.2 (18.) 235.5 (7.)
 Trefferlage 1.06 mm rechts, 1.44 mm hoch
 Streuwert 3.65, horizontal: 4.69, vertikal: 2.18

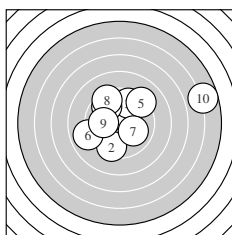
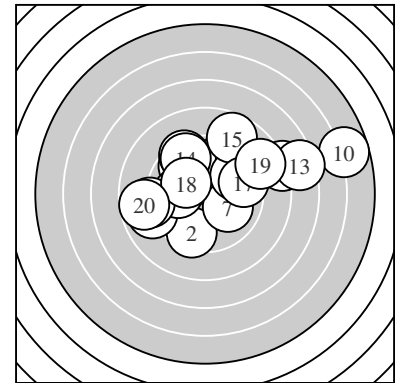

Serie 1:
 10.3 * 9.5 ↙ 9.6 ↗ 9.7 ↘ 9.2 ↗
 8.9 ← 10.0 ↘ 9.4 ↘ 10.0 ← 5.7 →
 beste Teiler 152.4 (1.) 235.5 (7.) 241.1 (9.)
 Trefferlage 0.61 mm rechts, 1.08 mm hoch
 Streuwert 3.82, horizontal: 4.78, vertikal: 2.53

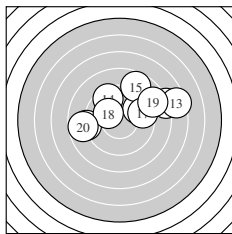

Serie 2:
 8.0 → 9.7 ↗ 7.4 → 9.5 ↘ 8.7 ↗
 8.9 ← 9.5 → 10.2 * 8.7 → 8.7 ←
 beste Teiler 197.2 (18.) 319.1 (12.) 363.1 (17.)
 Trefferlage 1.51 mm rechts, 1.80 mm hoch
 Streuwert 3.64, horizontal: 4.81, vertikal: 1.83

Unterschrift des Schuetzen

Ergebnis: **183.2** (173)
 Serien: 90.7 92.5
 Zaehler: 0 15 3 2 0 0 0 0 0 0
 Innenzehner: 0
 weiteste: 915 (9), 883 (4), 611 (17)
 beste Teiler 251.7 (13.) 258.6 (2.) 291.0 (12.)
 Trefferlage 1.75 mm rechts, 1.66 mm tief
 Streuwert 3.05, horizontal: 3.88, vertikal: 1.88

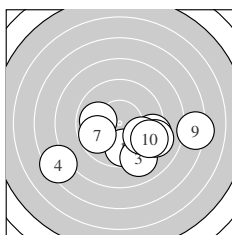
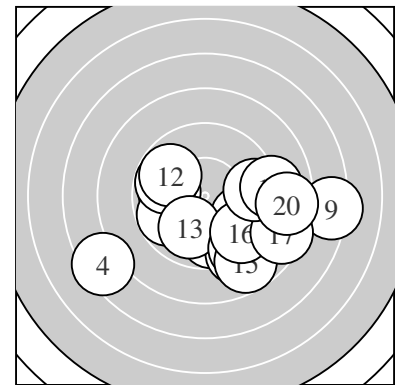

Serie 1:
 9.8 ↓ 9.9 ← 9.1 ↘ 7.4 ↙ 9.3 →
 9.1 → 9.8 ↙ 9.7 ↘ 7.3 → 9.3 →
 beste Teiler 258.6 (2.) 299.1 (7.) 299.5 (1.)
 Trefferlage 1.36 mm rechts, 2.03 mm tief
 Streuwert 3.44, horizontal: 4.61, vertikal: 1.56

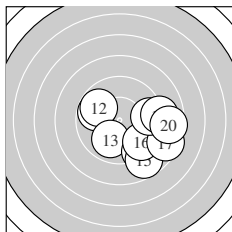

Serie 2:
 9.8 ↖ 9.8 ↖ 9.9 ↙ 9.2 ↘ 8.7 ↘
 9.5 ↘ 8.5 ↘ 9.5 → 9.0 → 8.6 →
 beste Teiler 251.7 (13.) 291.0 (12.) 295.0 (11.)
 Trefferlage 2.13 mm rechts, 1.30 mm tief
 Streuwert 2.73, horizontal: 3.19, vertikal: 2.17

Unterschrift des Schuetzen

Ergebnis: **193.4** (185)
 Serien: 96.2 97.2
 Zaehler: 9 7 4 0 0 0 0 0 0 0
 Innenzehner: 5
 weiteste: 617 (11), 596 (10), 594 (7)
 beste Teiler 86.4 (2.) 87.0 (6.) 156.1 (15.)
 Trefferlage 0.34 mm rechts, 1.88 mm tief
 Streuwert 2.25, horizontal: 2.74, vertikal: 1.62

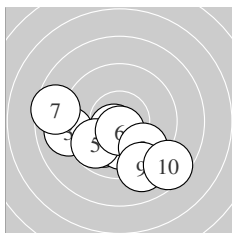
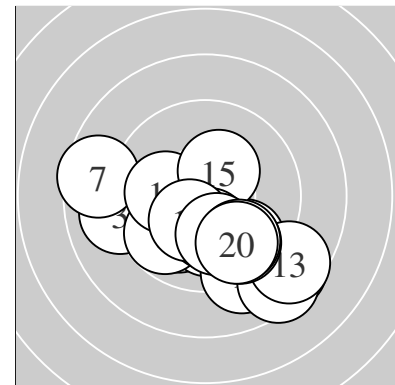

Serie 1:
 10.0 ↙ 10.6 * 9.1 ← 10.1 ↓ 9.8 ↗
 10.6 * 8.6 ← 9.7 ↘ 9.1 ↓ 8.6 ↘
 beste Teiler 86.4 (2.) 87.0 (6.) 216.5 (4.)
 Trefferlage 0.58 mm links, 1.81 mm tief
 Streuwert 2.47, horizontal: 3.12, vertikal: 1.57

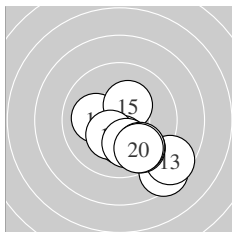

Serie 2:
 8.5 ↘ 10.1 ← 8.6 ↘ 9.7 ↘ 10.3 *
 10.2 * 10.3 * 10.1 ↓ 9.7 ↘ 9.7 ↘
 beste Teiler 156.1 (15.) 158.1 (17.) 182.1 (16.)
 Trefferlage 1.27 mm rechts, 1.95 mm tief
 Streuwert 1.90, horizontal: 2.04, vertikal: 1.75

Unterschrift des Schuetzen

Ergebnis: **200.5** (189)
 Serien: 99.1 101.4
 Zaehler: 10 9 1 0 0 0 0 0 0 0
 Innenzehner: 10
 weiteste: 513 (6), 404 (14), 338 (2)
 beste Teiler 50.2 (1.) 65.1 (13.) 104.4 (16.)
 Trefferlage 0.29 mm links, 0.38 mm hoch
 Streuwert 1.85, horizontal: 2.23, vertikal: 1.38

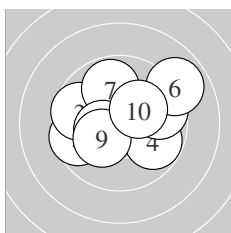
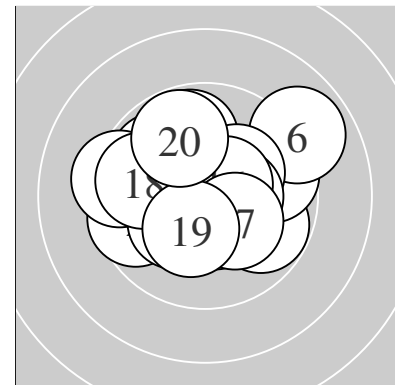

Serie 1:
 10.8 * 9.6 ← 9.7 ↖ 9.8 ↘ 9.7 →
 8.9 ↗ 9.8 ↑ 10.4 * 10.2 * 10.2 *
 beste Teiler 50.2 (1.) 139.5 (8.) 178.7 (9.)
 Trefferlage 0.13 mm rechts, 0.48 mm hoch
 Streuwert 2.12, horizontal: 2.59, vertikal: 1.51

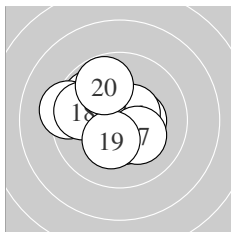

Serie 2:
 9.9 ↘ 10.5 * 10.7 * 9.3 ← 10.4 *
 10.5 * 10.2 * 9.8 ← 10.3 * 9.8 ↑
 beste Teiler 65.1 (13.) 104.4 (16.) 124.6 (12.)
 Trefferlage 0.72 mm links, 0.28 mm hoch
 Streuwert 1.60, horizontal: 1.84, vertikal: 1.32

Unterschrift des Schuetzen

Ergebnis: **196.0** (188)
 Serien: 97.9 98.1
 Zaehler: 11 6 3 0 0 0 0 0 0 0
 Innenzehner: 6
 weiteste: 634 (9), 552 (8), 528 (11)
 beste Teiler 66.2 (5.) 106.7 (15.) 115.6 (16.)
 Trefferlage 1.41 mm links, 1.09 mm hoch
 Streuwert 1.99, horizontal: 2.52, vertikal: 1.26

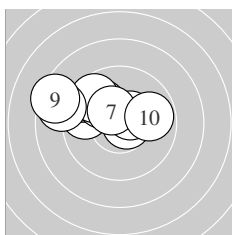
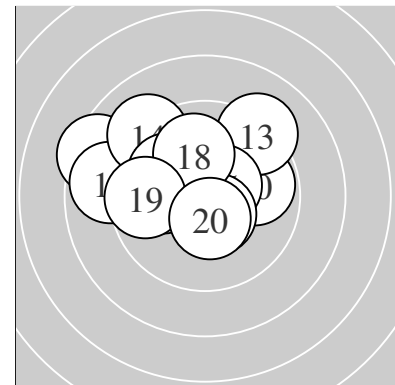

Serie 1:
 10.1 ↘ 9.6 ← 10.0 ↘ 9.7 ↘ 10.7 *
 10.5 * 10.4 * 8.7 ← 8.4 ← 9.8 →
 beste Teiler 66.2 (5.) 121.0 (6.) 137.9 (7.)
 Trefferlage 1.62 mm links, 1.24 mm hoch
 Streuwert 2.00, horizontal: 2.72, vertikal: 0.77

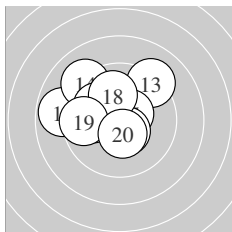

Serie 2:
 8.8 ← 10.0 ← 9.2 ↗ 9.1 ↘ 10.5 *
 10.5 * 10.0 ↘ 10.0 ↑ 9.6 ← 10.4 *
 beste Teiler 106.7 (15.) 115.6 (16.) 127.8 (20.)
 Trefferlage 1.20 mm links, 0.94 mm hoch
 Streuwert 2.07, horizontal: 2.43, vertikal: 1.64

Unterschrift des Schuetzen

Ergebnis: **189.1** (180)
 Serien: 91.5 97.6
 Zaehler: 8 7 2 3 0 0 0 0 0 0
 Innenzehner: 7
 weiteste: 787 (2), 782 (9), 779 (1)
 beste Teiler 108.9 (6.) 127.5 (18.) 132.9 (11.)
 Trefferlage 1.74 mm rechts, 0.41 mm hoch
 Streuwert 2.89, horizontal: 3.86, vertikal: 1.37

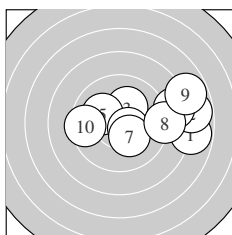
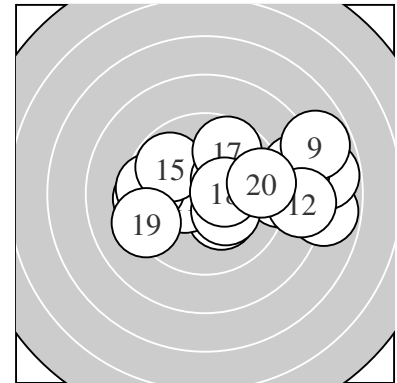

Serie 1:
 7.8 → 7.8 → 10.2 * 8.5 → 10.1 ↖
 10.5 * 10.3 * 9.0 → 7.8 → 9.5 ←
 beste Teiler 108.9 (6.) 174.0 (7.) 190.1 (3.)
 Trefferlage 3.06 mm rechts, 0.53 mm hoch
 Streuwert 3.11, horizontal: 4.16, vertikal: 1.44

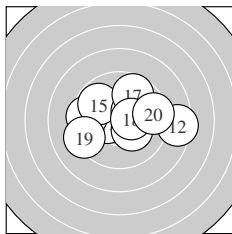

Serie 2:
 10.4 * 8.4 → 10.3 * 9.5 ← 9.8 ↖
 10.3 * 9.7 ↗ 10.4 * 9.3 ← 9.5 →
 beste Teiler 127.5 (18.) 132.9 (11.) 163.2 (16.)
 Trefferlage 0.43 mm rechts, 0.28 mm hoch
 Streuwert 2.46, horizontal: 3.20, vertikal: 1.36

Unterschrift des Schuetzen

Ergebnis: **204.6** (195)
 Serien: 101.5 103.1
 Zaehler: 16 3 1 0 0 0 0 0 0 0
 Innenzehner: 13
 weiteste: 642 (2), 299 (14), 257 (3)
 beste Teiler 39.0 (13.) 63.5 (15.) 76.9 (10.)
 Trefferlage 0.26 mm rechts, 0.20 mm tief
 Streuwert 1.59, horizontal: 1.99, vertikal: 1.07

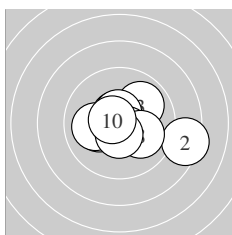
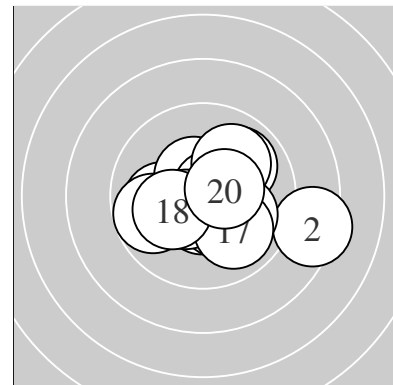

Serie 1:
 10.6 * 8.4 → 9.9 ↗ 10.6 * 10.6 *
 10.2 * 10.0 ← 10.1 ↘ 10.5 * 10.6 *
 beste Teiler 76.9 (10.) 84.0 (1.) 91.2 (4.)
 Trefferlage 0.53 mm rechts, 0.16 mm tief
 Streuwert 1.87, horizontal: 2.43, vertikal: 1.06

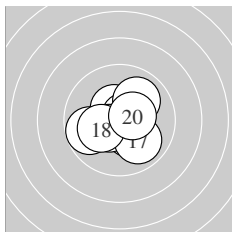

Serie 2:
 10.5 * 10.3 * 10.8 * 9.8 ← 10.7 *
 10.5 * 9.9 ↘ 10.2 * 10.0 ↗ 10.4 *
 beste Teiler 39.0 (13.) 63.5 (15.) 121.6 (11.)
 Trefferlage 0.00 mm , 0.23 mm tief
 Streuwert 1.33, horizontal: 1.50, vertikal: 1.13

Unterschrift des Schuetzen

Ergebnis: **201.1** (193)
 Serien: 100.5 100.6
 Zaehler: 15 3 2 0 0 0 0 0 0 0
 Innenzehner: 11
 weiteste: 608 (12), 563 (11), 478 (3)
 beste Teiler 52.9 (15.) 66.0 (18.) 75.8 (4.)
 Trefferlage 1.10 mm links, 0.33 mm tief
 Streuwert 1.83, horizontal: 2.48, vertikal: 0.71

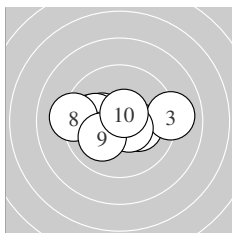
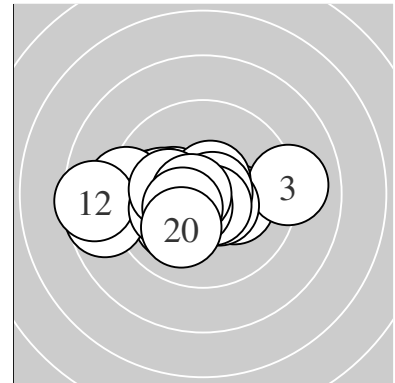

Serie 1:
 10.2 * 10.3 * 9.0 → 10.7 * 9.9 ←
 10.5 * 10.0 ← 9.2 ← 10.1 ✓ 10.6 *
 beste Teiler 75.8 (4.) 83.7 (10.) 108.8 (6.)
 Trefferlage 0.40 mm links, 0.05 mm tief
 Streuwert 1.91, horizontal: 2.62, vertikal: 0.69

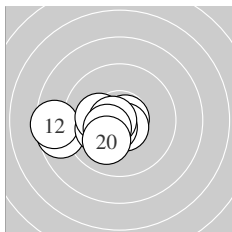

Serie 2:
 8.7 ← 8.5 ← 10.1 ← 10.2 * 10.7 *
 10.6 * 10.6 * 10.7 * 10.4 * 10.1 ✓
 beste Teiler 52.9 (15.) 66.0 (18.) 78.8 (16.)
 Trefferlage 1.80 mm links, 0.61 mm tief
 Streuwert 1.66, horizontal: 2.26, vertikal: 0.65

Unterschrift des Schuetzen

Ergebnis: **164.9** (153)
 Serien: 81.7 83.2
 Zaehler: 2 4 5 5 2 2 0 0 0 0
 Innenzehner: 2
 weiteste: 1343 (3), 1280 (18), 1111 (8)
 beste Teiler 63.1 (2.) 200.3 (6.) 253.0 (20.)
 Trefferlage 0.63 mm rechts, 3.92 mm tief
 Streuwert 4.73, horizontal: 5.57, vertikal: 3.71

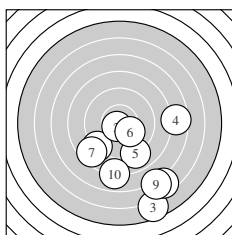
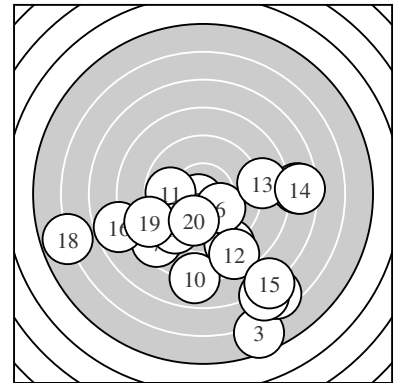

Serie 1:
 9.0 ↙ 10.7 * 5.6 ↘ 7.6 → 8.9 ↘
 10.2 * 8.6 ↙ 6.5 ↘ 6.7 ↘ 7.9 ↓
 beste Teiler 63.1 (2.) 200.3 (6.) 481.6 (1.)
 Trefferlage 2.07 mm rechts, 5.15 mm tief
 Streuwert 4.26, horizontal: 4.27, vertikal: 4.25

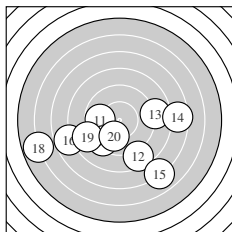

Serie 2:
 9.8 ← 8.5 ↘ 8.8 → 7.5 → 7.0 ↘
 7.7 ← 9.4 ↙ 5.8 ← 8.8 ← 9.9 ↓
 beste Teiler 253.0 (20.) 292.2 (11.) 398.2 (17.)
 Trefferlage 0.80 mm links, 2.68 mm tief
 Streuwert 5.02, horizontal: 6.53, vertikal: 2.77

Unterschrift des Schuetzen

Ergebnis: **206.9** (198)
 Serien: 103.3 103.6
 Zaehler: 18 2 0 0 0 0 0 0 0 0
 Innenzehner: 16
 weiteste: 349 (4), 254 (14), 241 (6)
 beste Teiler 38.4 (1.) 79.4 (5.) 97.0 (11.)
 Trefferlage 0.22 mm rechts, 0.39 mm hoch
 Streuwert 1.16, horizontal: 1.42, vertikal: 0.84

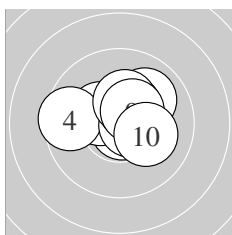
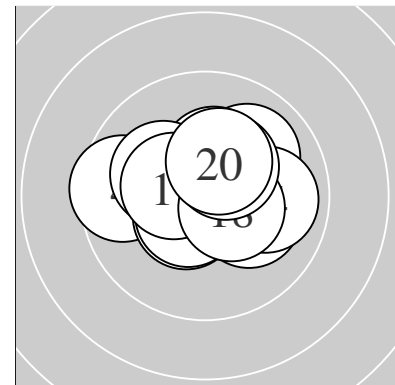

Serie 1:
 10.8 * 10.4 * 10.6 * 9.6 ← 10.6 *
 10.0 ↗ 10.4 * 10.3 * 10.5 * 10.1 ↘
 beste Teiler 38.4 (1.) 79.4 (5.) 100.2 (3.)
 Trefferlage 0.26 mm rechts, 0.53 mm hoch
 Streuwert 1.26, horizontal: 1.59, vertikal: 0.80

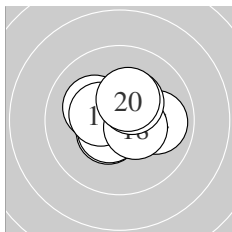

Serie 2:
 10.6 * 10.2 * 10.4 * 9.9 → 10.5 *
 10.5 * 10.4 * 10.5 * 10.3 * 10.3 *
 beste Teiler 97.0 (11.) 103.2 (16.) 116.7 (15.)
 Trefferlage 0.19 mm rechts, 0.25 mm hoch
 Streuwert 1.12, horizontal: 1.31, vertikal: 0.90

Unterschrift des Schuetzen

Ergebnis: **194.8** (186)
 Serien: 98.3 96.5
 Zaehler: 8 10 2 0 0 0 0 0 0 0
 Innenzehner: 6
 weiteste: 591 (14), 530 (10), 480 (20)
 beste Teiler 71.8 (4.) 135.5 (1.) 137.8 (8.)
 Trefferlage 1.25 mm links, 0.55 mm tief
 Streuwert 2.23, horizontal: 2.65, vertikal: 1.72

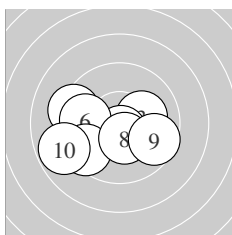
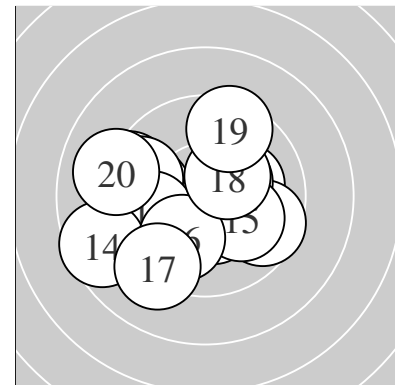

Serie 1:
 10.4 * 9.3 ← 10.2 * 10.7 * 9.6 ↙
 9.8 ← 9.5 ↙ 10.4 * 9.6 → 8.8 ←
 beste Teiler 71.8 (4.) 135.5 (1.) 137.8 (8.)
 Trefferlage 1.08 mm links, 0.79 mm tief
 Streuwert 2.12, horizontal: 2.75, vertikal: 1.19

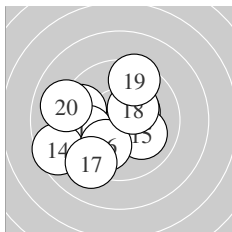

Serie 2:
 9.6 ← 10.4 * 9.8 ← 8.6 ↙ 10.1 →
 10.0 ↙ 9.2 ↙ 10.3 * 9.5 ↑ 9.0 ←
 beste Teiler 146.3 (12.) 155.8 (18.) 222.6 (15.)
 Trefferlage 1.42 mm links, 0.31 mm tief
 Streuwert 2.44, horizontal: 2.69, vertikal: 2.16

Unterschrift des Schuetzen

Ergebnis: **190.3** (181)
 Serien: 91.5 98.8
 Zaehler: 7 9 3 0 1 0 0 0 0 0
 Innenzehner: 4
 weiteste: 1204 (9), 741 (11), 565 (6)
 beste Teiler 92.3 (17.) 108.8 (12.) 109.9 (19.)
 Trefferlage 0.83 mm links, 0.12 mm tief
 Streuwert 3.11, horizontal: 4.07, vertikal: 1.67

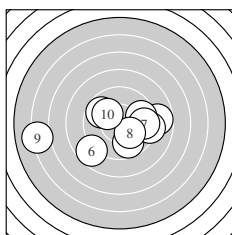
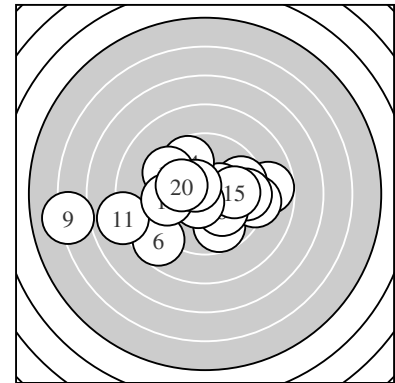

Serie 1:
 8.8 → 9.7 ↘ 9.2 → 9.6 → 9.7 ↖
 8.7 ↙ 9.5 → 10.1 ↘ 6.1 ← 10.1 ↖
 beste Teiler 203.0 (8.) 219.8 (10.) 303.9 (2.)
 Trefferlage 0.11 mm links, 0.64 mm tief
 Streuwert 3.89, horizontal: 5.18, vertikal: 1.87

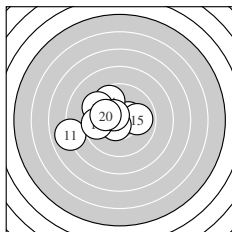

Serie 2:
 8.0 ← 10.5 * 10.4 * 9.7 ↖ 9.9 →
 9.5 ↖ 10.6 * 9.6 ← 10.5 * 10.1 ↖
 beste Teiler 92.3 (17.) 108.8 (12.) 109.9 (19.)
 Trefferlage 1.55 mm links, 0.39 mm hoch
 Streuwert 2.10, horizontal: 2.65, vertikal: 1.35

Unterschrift des Schuetzen

Ergebnis: **201.6** (191)
 Serien: 101.0 100.6
 Zaehler: 13 5 2 0 0 0 0 0 0 0
 Innenzehner: 13
 weiteste: 590 (14), 505 (12), 433 (7)
 beste Teiler 34.9 (4.) 68.4 (9.) 83.4 (11.)
 Trefferlage 0.80 mm rechts, 0.23 mm hoch
 Streuwert 1.82, horizontal: 2.43, vertikal: 0.84

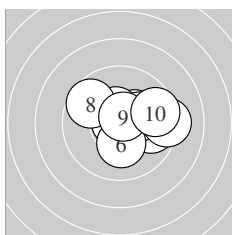
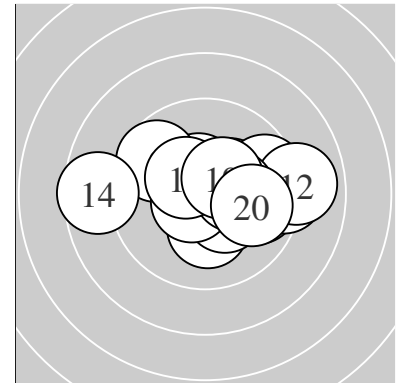

Serie 1:
 10.3 * 10.5 * 9.8 → 10.8 * 10.2 *
 10.2 * 9.2 → 9.7 ↖ 10.7 * 9.6 →
 beste Teiler 34.9 (4.) 68.4 (9.) 114.7 (2.)
 Trefferlage 1.08 mm rechts, 0.37 mm hoch
 Streuwert 1.63, horizontal: 2.08, vertikal: 1.01

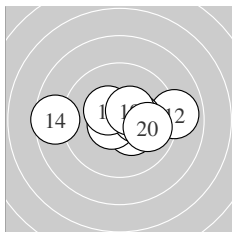

Serie 2:
 10.6 * 8.9 → 10.5 * 8.6 ← 10.4 *
 10.6 * 10.3 * 10.4 * 10.4 * 9.9 →
 beste Teiler 83.4 (11.) 84.2 (16.) 119.5 (13.)
 Trefferlage 0.51 mm rechts, 0.09 mm hoch
 Streuwert 2.05, horizontal: 2.82, vertikal: 0.65

Unterschrift des Schuetzen

Ergebnis: **190.7** (181)
 Serien: 95.4 95.3
 Zaehler: 8 7 4 0 1 0 0 0 0 0
 Innenzehner: 4
 weiteste: 1015 (17), 623 (6), 621 (2)
 beste Teiler 98.4 (15.) 113.2 (11.) 183.4 (20.)
 Trefferlage 2.02 mm rechts, 0.70 mm tief
 Streuwert 2.59, horizontal: 2.98, vertikal: 2.13

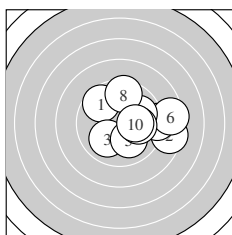
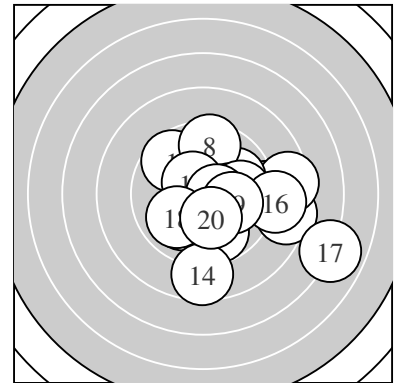

Serie 1:
 9.6 ↘ 8.5 → 10.0 ↙ 9.1 → 10.1 ↘
 8.5 → 9.9 → 9.5 ↑ 10.0 → 10.2 *
 beste Teiler 190.0 (10.) 225.3 (5.) 228.8 (9.)
 Trefferlage 2.11 mm rechts, 0.24 mm hoch
 Streuwert 2.39, horizontal: 2.86, vertikal: 1.79

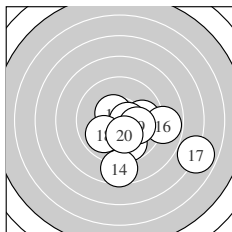

Serie 2:
 10.5 * 9.9 → 9.8 ↘ 8.6 ↓ 10.6 *
 8.8 → 6.9 → 9.9 ↙ 10.1 → 10.2 *
 beste Teiler 98.4 (15.) 113.2 (11.) 183.4 (20.)
 Trefferlage 1.93 mm rechts, 1.64 mm tief
 Streuwert 2.73, horizontal: 3.25, vertikal: 2.09

Unterschrift des Schuetzen

Ergebnis: **198.5** (188)
 Serien: 98.5 100.0
 Zaehler: 9 10 1 0 0 0 0 0 0 0
 Innenzehner: 5
 weiteste: 518 (20), 423 (9), 376 (5)
 beste Teiler 55.2 (18.) 84.5 (19.) 118.8 (2.)
 Trefferlage 0.72 mm links, 0.84 mm hoch
 Streuwert 1.85, horizontal: 2.05, vertikal: 1.63

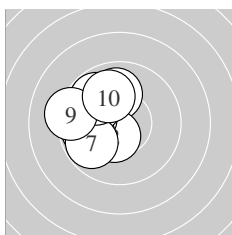
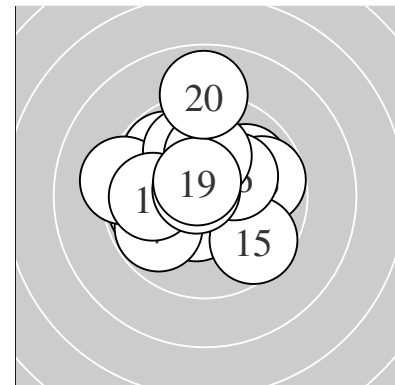

Serie 1:
 10.0 ↑ 10.5 * 10.0 ← 9.8 ← 9.4 ←
 9.9 ↘ 9.8 ↙ 9.8 ↘ 9.3 ← 10.0 ↗
 beste Teiler 118.8 (2.) 247.1 (10.) 248.8 (1.)
 Trefferlage 2.12 mm links, 0.69 mm hoch
 Streuwert 1.36, horizontal: 1.28, vertikal: 1.44

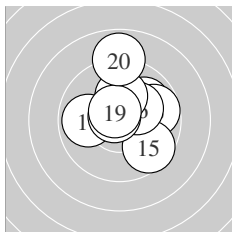

Serie 2:
 9.9 ← 9.9 ↗ 9.7 → 10.4 * 9.6 ↘
 10.2 * 10.1 ↑ 10.7 * 10.6 * 8.9 ↑
 beste Teiler 55.2 (18.) 84.5 (19.) 144.6 (14.)
 Trefferlage 0.67 mm rechts, 0.99 mm hoch
 Streuwert 1.78, horizontal: 1.69, vertikal: 1.86

Unterschrift des Schuetzen

Ergebnis: **199.7** (188)
 Serien: 98.4 101.3
 Zaehler: 10 9 0 1 0 0 0 0 0 0
 Innenzehner: 10
 weiteste: 867 (8), 348 (7), 307 (15)
 beste Teiler 88.0 (12.) 107.4 (9.) 123.6 (14.)
 Trefferlage 0.22 mm rechts, 0.52 mm tief
 Streuwert 2.08, horizontal: 2.70, vertikal: 1.17

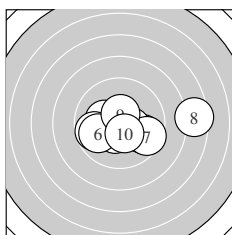
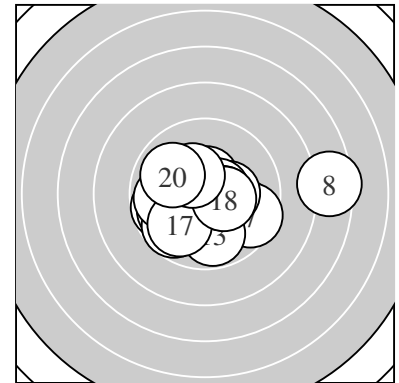

Serie 1:
 10.4 * 10.2 * 9.7 ← 9.8 ↘ 10.4 *
 9.9 ← 9.6 ↘ 7.5 → 10.5 * 10.4 *
 beste Teiler 107.4 (9.) 130.6 (10.) 135.3 (1.)
 Trefferlage 0.87 mm rechts, 0.54 mm tief
 Streuwert 2.50, horizontal: 3.40, vertikal: 0.94

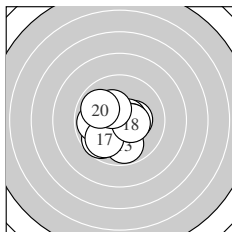

Serie 2:
 10.3 * 10.6 * 9.8 ↓ 10.5 * 9.7 ↙
 9.9 ← 9.9 ↙ 10.4 * 10.3 * 9.9 ↘
 beste Teiler 88.0 (12.) 123.6 (14.) 135.3 (18.)
 Trefferlage 0.42 mm links, 0.51 mm tief
 Streuwert 1.56, horizontal: 1.69, vertikal: 1.41

Unterschrift des Schuetzen

Ergebnis: **194.6** (188)
 Serien: 100.8 93.8
 Zaehler: 12 5 2 1 0 0 0 0 0 0
 Innenzehner: 7
 weiteste: 951 (20), 689 (19), 543 (15)
 beste Teiler 134.6 (17.) 142.8 (3.) 147.9 (9.)
 Trefferlage 0.39 mm links, 0.42 mm hoch
 Streuwert 2.65, horizontal: 3.49, vertikal: 1.35

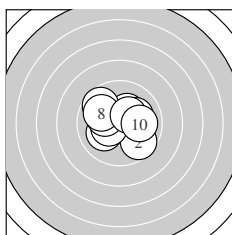
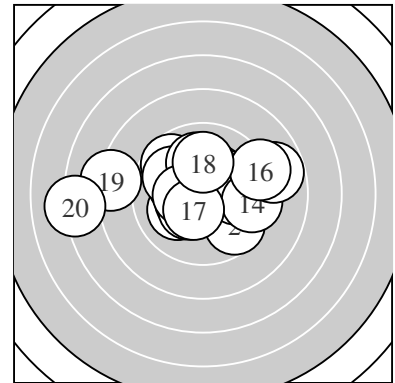

Serie 1:
 10.1 ↙ 9.7 ↘ 10.4 * 10.3 * 9.7 ↖
 10.2 * 10.1 → 9.9 ↖ 10.4 * 10.0 →
 beste Teiler 142.8 (3.) 147.9 (9.) 168.1 (4.)
 Trefferlage 0.09 mm links, 0.34 mm hoch
 Streuwert 1.70, horizontal: 2.00, vertikal: 1.34

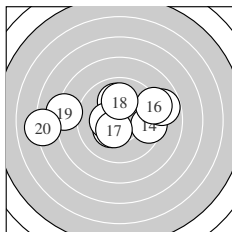

Serie 2:
 10.3 * 10.0 ↑ 10.4 * 9.5 → 8.8 →
 9.1 → 10.4 * 10.0 ↑ 8.2 ← 7.1 ←
 beste Teiler 134.6 (17.) 148.2 (13.) 155.6 (11.)
 Trefferlage 0.70 mm links, 0.51 mm hoch
 Streuwert 3.43, horizontal: 4.63, vertikal: 1.44

Unterschrift des Schuetzen

Ergebnis: **202.3** (194)
 Serien: 101.6 100.7
 Zaehler: 14 6 0 0 0 0 0 0 0 0
 Innenzehner: 12
 weiteste: 495 (20), 378 (8), 302 (7)
 beste Teiler 80.6 (3.) 91.0 (19.) 109.5 (5.)
 Trefferlage 0.45 mm links, 0.01 mm hoch
 Streuwert 1.65, horizontal: 2.07, vertikal: 1.09

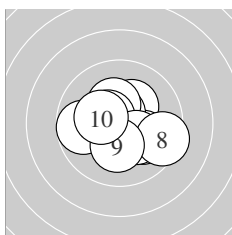
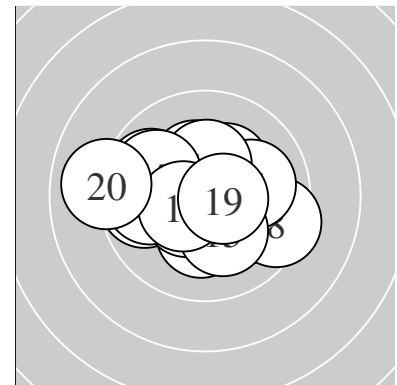

Serie 1:
 10.3 * 10.1 ↘ 10.6 * 10.3 * 10.5 *
 10.2 * 9.7 ← 9.4 → 10.2 * 10.3 *
 beste Teiler 80.6 (3.) 109.5 (5.) 159.7 (4.)
 Trefferlage 0.15 mm rechts, 0.11 mm tief
 Streuwert 1.58, horizontal: 1.87, vertikal: 1.21

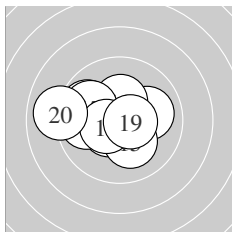

Serie 2:
 10.0 → 9.8 ↖ 10.3 * 10.5 * 10.2 *
 9.9 ← 9.9 ↖ 10.5 * 10.6 * 9.0 ←
 beste Teiler 91.0 (19.) 119.6 (14.) 120.7 (18.)
 Trefferlage 1.06 mm links, 0.14 mm hoch
 Streuwert 1.69, horizontal: 2.17, vertikal: 1.01

Unterschrift des Schuetzen

Ergebnis: **187.1** (177)
 Serien: 90.5 96.6
 Zaehler: 7 6 4 3 0 0 0 0 0 0
 Innenzehner: 4
 weiteste: 931 (7), 806 (4), 751 (6)
 beste Teiler 107.6 (15.) 133.5 (9.) 152.5 (16.)
 Trefferlage 2.08 mm links, 0.09 mm hoch
 Streuwert 2.97, horizontal: 3.93, vertikal: 1.47

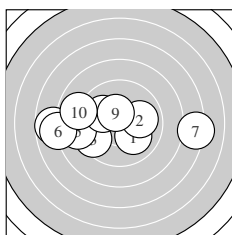
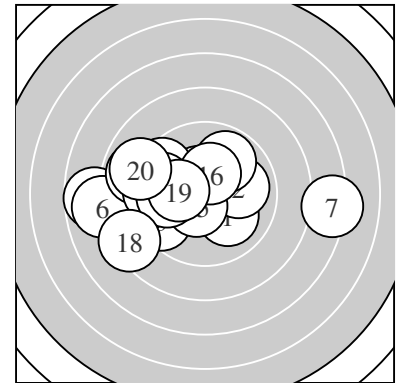

Serie 1:
 10.0 ↘ 10.0 → 9.5 ↙ 7.7 ← 8.9 ←
 7.9 ← 7.2 → 10.0 ↘ 10.4 * 8.9 ←
 beste Teiler 133.5 (9.) 227.1 (1.) 232.3 (8.)
 Trefferlage 1.79 mm links, 0.21 mm tief
 Streuwert 3.81, horizontal: 5.25, vertikal: 1.22

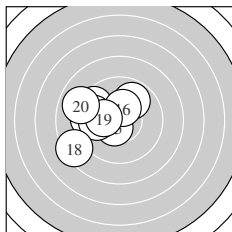

Serie 2:
 9.5 ↘ 9.6 ← 9.9 ↗ 9.5 ← 10.5 *
 10.3 * 9.8 ← 8.4 ↙ 10.2 * 8.9 ←
 beste Teiler 107.6 (15.) 152.5 (16.) 194.4 (19.)
 Trefferlage 2.37 mm links, 0.41 mm hoch
 Streuwert 1.97, horizontal: 2.21, vertikal: 1.69

Unterschrift des Schuetzen

Ergebnis: **198.0** (190)
 Serien: 98.4 99.6
 Zaehler: 10 10 0 0 0 0 0 0 0 0
 Innenzehner: 7
 weiteste: 491 (12), 480 (16), 421 (8)
 beste Teiler 42.5 (17.) 73.7 (11.) 82.1 (9.)
 Trefferlage 1.29 mm rechts, 0.12 mm tief
 Streuwert 1.92, horizontal: 2.39, vertikal: 1.29

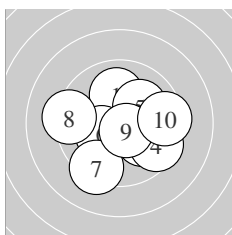
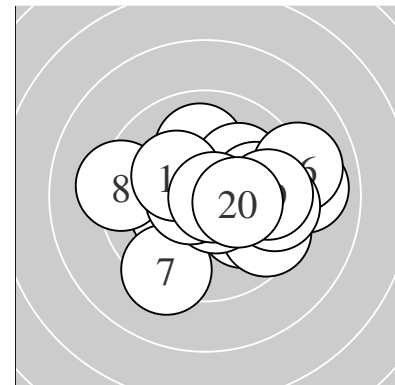

Serie 1:
 10.0 ↑ 10.0 ↘ 9.8 ↘ 9.5 ↘ 10.1 ↗
 10.3 * 9.3 ↙ 9.3 ← 10.6 * 9.5 →
 beste Teiler 82.1 (9.) 168.6 (6.) 216.6 (5.)
 Trefferlage 0.58 mm rechts, 0.44 mm tief
 Streuwert 2.15, horizontal: 2.53, vertikal: 1.70

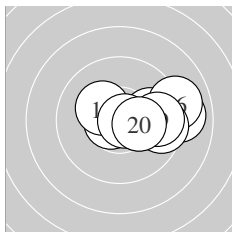

Serie 2:
 10.7 * 9.0 → 10.3 * 9.9 → 10.3 *
 9.0 → 10.8 * 9.6 → 9.7 → 10.3 *
 beste Teiler 42.5 (17.) 73.7 (11.) 161.6 (13.)
 Trefferlage 2.01 mm rechts, 0.19 mm hoch
 Streuwert 1.57, horizontal: 2.13, vertikal: 0.61

Unterschrift des Schuetzen

Ergebnis: **194.7** (187)
 Serien: 97.2 97.5
 Zaehler: 10 8 1 1 0 0 0 0 0 0
 Innenzehner: 5
 weiteste: 783 (13), 522 (9), 432 (3)
 beste Teiler 130.3 (2.) 155.6 (15.) 172.4 (17.)
 Trefferlage 0.66 mm rechts, 0.40 mm hoch
 Streuwert 2.40, horizontal: 3.01, vertikal: 1.57

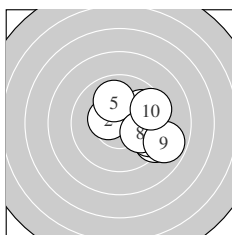
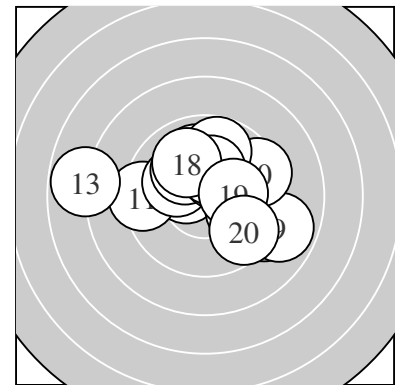

Serie 1:
 10.2 * 10.4 * 9.2 ↘ 9.9 ↗ 10.0 ↑
 9.6 ↗ 9.5 ↗ 10.0 ↗ 8.9 ↗ 9.5 ↗
 beste Teiler 130.3 (2.) 193.7 (1.) 247.3 (8.)
 Trefferlage 2.31 mm rechts, 0.14 mm tief
 Streuwert 1.75, horizontal: 1.90, vertikal: 1.58

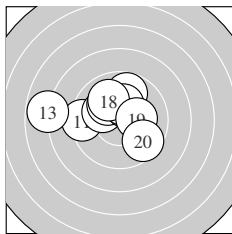

Serie 2:
 9.3 ← 10.1 ↖ 7.8 ← 10.1 ↖ 10.3 *
 9.8 ↑ 10.3 * 10.0 ↖ 10.2 * 9.6 ↘
 beste Teiler 155.6 (15.) 172.4 (17.) 184.7 (19.)
 Trefferlage 0.99 mm links, 0.95 mm hoch
 Streuwert 2.39, horizontal: 3.07, vertikal: 1.42

Unterschrift des Schuetzen

Ergebnis: **197.0** (192)
 Serien: 97.4 99.6
 Zaehler: 13 6 1 0 0 0 0 0 0 0
 Innenzehner: 7
 weiteste: 703 (9), 438 (15), 433 (1)
 beste Teiler 137.0 (2.) 148.4 (7.) 169.0 (13.)
 Trefferlage 0.20 mm links, 0.18 mm tief
 Streuwert 2.21, horizontal: 2.72, vertikal: 1.53

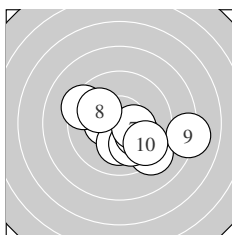
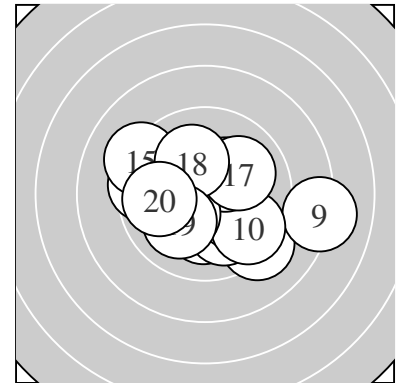

Serie 1:
 9.2 ↘ 10.4 * 10.2 * 10.0 ↘ 10.1 ↘
 9.4 ↖ 10.4 * 10.0 ↖ 8.1 → 9.6 ↘
 beste Teiler 137.0 (2.) 148.4 (7.) 200.2 (3.)
 Trefferlage 0.98 mm rechts, 0.89 mm tief
 Streuwert 2.37, horizontal: 2.99, vertikal: 1.50

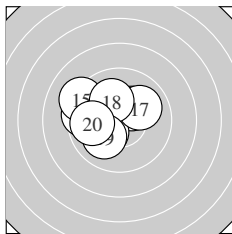

Serie 2:
 10.2 * 10.3 * 10.3 * 9.5 ← 9.2 ↖
 10.2 * 10.0 ↗ 10.1 ↘ 10.0 ↙ 9.8 ←
 beste Teiler 169.0 (13.) 171.7 (12.) 179.0 (16.)
 Trefferlage 1.38 mm links, 0.52 mm hoch
 Streuwert 1.60, horizontal: 1.88, vertikal: 1.25

Unterschrift des Schuetzen

Ergebnis: **197.0** (190)
 Serien: 97.9 99.1
 Zaehler: 11 8 1 0 0 0 0 0 0 0
 Innenzehner: 5
 weiteste: 665 (7), 484 (15), 471 (10)
 beste Teiler 34.4 (4.) 83.2 (20.) 172.3 (17.)
 Trefferlage 1.09 mm rechts, 1.34 mm hoch
 Streuwert 1.86, horizontal: 2.43, vertikal: 1.01

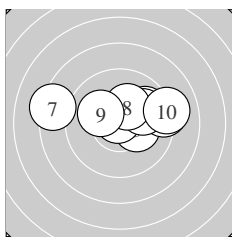
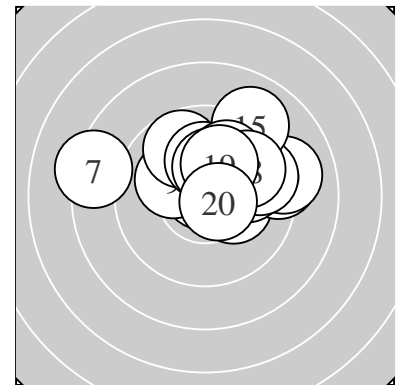

Serie 1:
 9.8 → 10.0 → 10.3 * 10.8 * 9.2 →
 10.0 → 8.3 ← 10.3 * 10.1 ↖ 9.1 →
 beste Teiler 34.4 (4.) 173.0 (3.) 174.8 (8.)
 Trefferlage 0.96 mm rechts, 0.93 mm hoch
 Streuwert 2.33, horizontal: 3.23, vertikal: 0.63

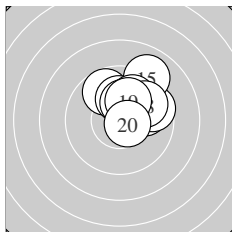

Serie 2:
 9.9 → 9.6 → 9.7 ↖ 10.1 ↑ 9.0 ↗
 10.0 ↗ 10.3 * 9.8 ↗ 10.1 ↗ 10.6 *
 beste Teiler 83.2 (20.) 172.3 (17.) 203.6 (19.)
 Trefferlage 1.23 mm rechts, 1.75 mm hoch
 Streuwert 1.30, horizontal: 1.42, vertikal: 1.18

Unterschrift des Schuetzen

Ergebnis: **180.1** (172)
 Serien: 87.2 92.9
 Zaehler: 4 8 5 2 1 0 0 0 0 0
 Innenzehner: 3
 weiteste: 1025 (2), 873 (5), 770 (9)
 beste Teiler 159.1 (19.) 164.0 (18.) 197.4 (3.)
 Trefferlage 2.48 mm links, 0.77 mm hoch
 Streuwert 3.45, horizontal: 4.32, vertikal: 2.26

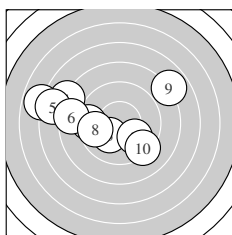
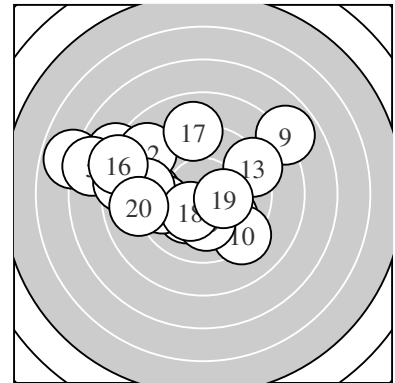

Serie 1:
 8.0 ↖ 6.9 ← 10.2 * 9.4 ← 7.5 ←
 8.5 ← 9.9 ↘ 9.7 ← 7.9 ↗ 9.2 ↘
 beste Teiler 197.4 (3.) 257.7 (7.) 319.4 (8.)
 Trefferlage 2.83 mm links, 0.62 mm hoch
 Streuwert 4.11, horizontal: 5.27, vertikal: 2.45

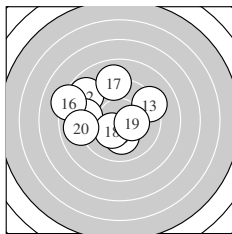

Serie 2:
 8.8 ← 8.8 ↖ 9.2 ↗ 9.2 ← 10.1 ↓
 8.2 ← 9.0 ↑ 10.3 * 10.3 * 9.0 ←
 beste Teiler 159.1 (19.) 164.0 (18.) 210.4 (15.)
 Trefferlage 2.12 mm links, 0.92 mm hoch
 Streuwert 2.84, horizontal: 3.38, vertikal: 2.17

Unterschrift des Schuetzen

Ergebnis: **203.4** (194)
 Serien: 99.7 103.7
 Zaehler: 14 6 0 0 0 0 0 0 0 0
 Innenzehner: 11
 weiteste: 432 (10), 371 (2), 338 (8)
 beste Teiler 59.2 (20.) 64.8 (17.) 78.7 (19.)
 Trefferlage 0.12 mm rechts, 0.57 mm hoch
 Streuwert 1.55, horizontal: 1.69, vertikal: 1.39

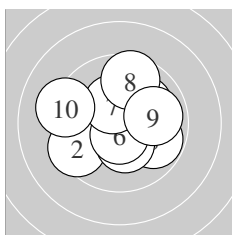
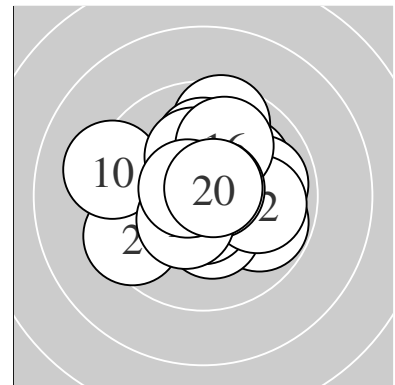

Serie 1:
 10.1 ↗ 9.5 ↖ 9.8 ↘ 10.3 * 10.4 *
 10.6 * 10.3 * 9.6 ↑ 9.9 → 9.2 ←
 beste Teiler 88.0 (6.) 147.7 (5.) 153.7 (7.)
 Trefferlage 0.01 mm links, 0.37 mm hoch
 Streuwert 1.98, horizontal: 2.25, vertikal: 1.67

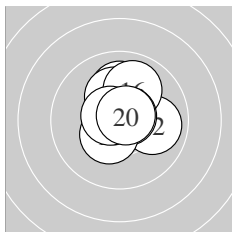

Serie 2:
 10.5 * 9.9 → 10.6 * 10.1 ↑ 10.2 *
 10.0 ↗ 10.7 * 10.4 * 10.6 * 10.7 *
 beste Teiler 59.2 (20.) 64.8 (17.) 78.7 (19.)
 Trefferlage 0.25 mm rechts, 0.77 mm hoch
 Streuwert 1.04, horizontal: 0.98, vertikal: 1.10

Unterschrift des Schuetzen

Ergebnis: **187.9** (179)
 Serien: 95.0 92.9
 Zaehler: 4 11 5 0 0 0 0 0 0 0
 Innenzehner: 3
 weiteste: 676 (13), 582 (9), 575 (4)
 beste Teiler 105.2 (6.) 182.4 (14.) 197.4 (18.)
 Trefferlage 0.42 mm links, 1.74 mm tief
 Streuwert 2.75, horizontal: 3.54, vertikal: 1.63

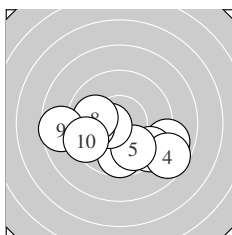
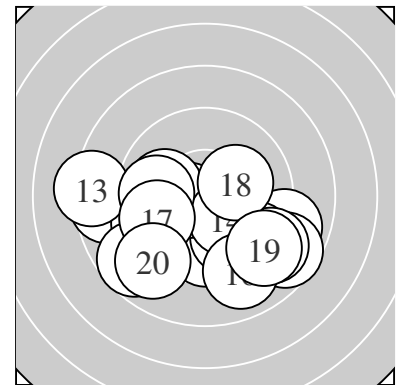

Serie 1:
 8.9 ↘ 9.4 ↘ 9.7 ↓ 8.7 ↘ 9.8 ↓
 10.5 * 9.9 ← 10.0 ← 8.6 ← 9.5 ←
 beste Teiler 105.2 (6.) 246.0 (8.) 275.3 (7.)
 Trefferlage 0.13 mm links, 1.55 mm tief
 Streuwert 2.69, horizontal: 3.57, vertikal: 1.32

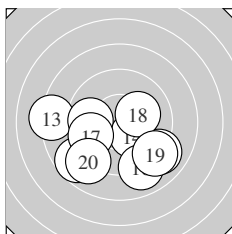

Serie 2:
 8.7 ↙ 9.0 ↘ 8.2 ← 10.2 * 9.8 ←
 9.0 ↓ 9.7 ← 10.2 * 9.1 ↘ 9.0 ↙
 beste Teiler 182.4 (14.) 197.4 (18.) 289.4 (15.)
 Trefferlage 0.71 mm links, 1.94 mm tief
 Streuwert 2.94, horizontal: 3.67, vertikal: 1.95

Unterschrift des Schuetzen

Ergebnis: **180.4** (170)
 Serien: 83.2 97.2
 Zaehler: 4 10 3 1 1 0 0 1 0 0
 Innenzehner: 3
 weiteste: 1862 (3), 1091 (9), 913 (7)
 beste Teiler 53.3 (13.) 148.9 (6.) 188.0 (18.)
 Trefferlage 0.93 mm rechts, 0.64 mm hoch
 Streuwert 4.49, horizontal: 5.96, vertikal: 2.21

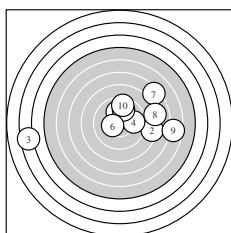
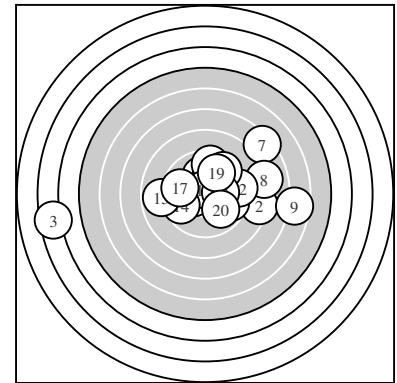

Serie 1:
 10.0 ↑ 8.3 → 3.5 ← 9.8 → 9.8 ↑
 10.4 * 7.3 ↗ 8.0 → 6.6 → 9.5 ↑
 beste Teiler 148.9 (6.) 229.0 (1.) 277.2 (5.)
 Trefferlage 1.54 mm rechts, 0.99 mm hoch
 Streuwert 6.02, horizontal: 8.05, vertikal: 2.76

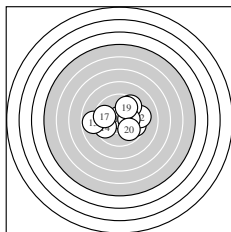

Serie 2:
 9.6 → 9.3 → 10.7 * 9.7 ← 8.8 ←
 9.5 ↗ 9.7 ← 10.2 * 9.8 ↑ 9.9 ↘
 beste Teiler 53.3 (13.) 188.0 (18.) 264.4 (20.)
 Trefferlage 0.32 mm rechts, 0.28 mm hoch
 Streuwert 2.43, horizontal: 3.07, vertikal: 1.54

Unterschrift des Schuetzen

Ergebnis: **187.3** (179)
 Serien: 92.3 95.0
 Zaehler: 8 5 6 0 1 0 0 0 0 0
 Innenzehner: 5
 weiteste: 1115 (5), 706 (7), 603 (4)
 beste Teiler 71.5 (8.) 149.6 (3.) 160.9 (20.)
 Trefferlage 1.07 mm rechts, 0.41 mm tief
 Streuwert 3.28, horizontal: 4.04, vertikal: 2.28

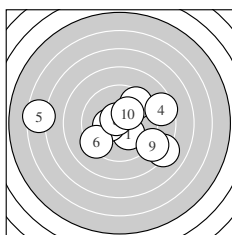
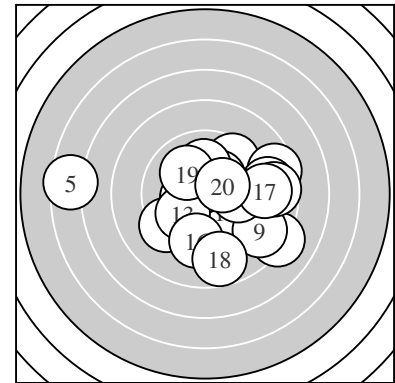

Serie 1:
 10.2 * 9.5 ↗ 10.4 * 8.5 → 6.5 ←
 9.3 ↙ 8.1 ↘ 10.7 * 8.8 ↘ 10.3 *
 beste Teiler 71.5 (8.) 149.6 (3.) 175.6 (10.)
 Trefferlage 0.45 mm rechts, 0.34 mm tief
 Streuwert 3.91, horizontal: 5.06, vertikal: 2.23

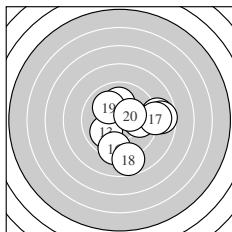

Serie 2:
 8.9 → 8.7 → 10.0 ↙ 9.9 → 10.0 ↑
 9.4 ↓ 9.0 → 8.8 ↓ 10.0 ↘ 10.3 *
 beste Teiler 160.9 (20.) 229.2 (15.) 229.8 (19.)
 Trefferlage 1.70 mm rechts, 0.47 mm tief
 Streuwert 2.64, horizontal: 2.82, vertikal: 2.44

Unterschrift des Schuetzen

Ergebnis: **191.2** (180)
 Serien: 97.7 93.5
 Zaehler: 5 11 3 1 0 0 0 0 0 0
 Innenzehner: 4
 weiteste: 785 (11), 635 (16), 557 (20)
 beste Teiler 45.3 (13.) 102.6 (4.) 133.3 (10.)
 Trefferlage 0.21 mm rechts, 1.85 mm hoch
 Streuwert 2.50, horizontal: 3.40, vertikal: 0.97

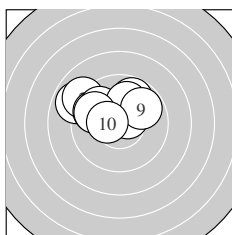
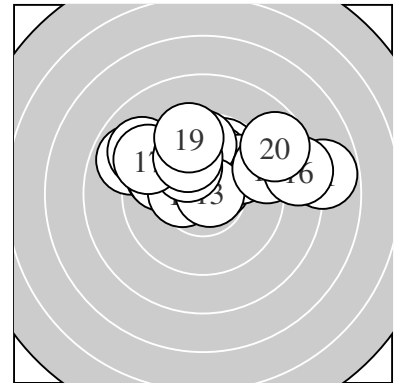

Serie 1:
 8.9 ↘ 9.0 ↘ 9.7 ↘ 10.5 * 9.8 ↗
 9.8 ↘ 10.0 ↑ 9.8 ↘ 9.8 ↗ 10.4 *
 beste Teiler 102.6 (4.) 133.3 (10.) 237.8 (7.)
 Trefferlage 1.23 mm links, 1.62 mm hoch
 Streuwert 1.81, horizontal: 2.41, vertikal: 0.87

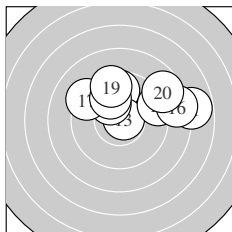

Serie 2:
 7.8 → 9.7 ↑ 10.8 * 10.2 * 9.2 →
 8.4 → 9.3 ↘ 9.9 ↘ 9.5 ↑ 8.7 →
 beste Teiler 45.3 (13.) 200.3 (14.) 256.8 (18.)
 Trefferlage 1.66 mm rechts, 2.07 mm hoch
 Streuwert 2.74, horizontal: 3.73, vertikal: 1.05

Unterschrift des Schuetzen

LG 20 ZR – Wertung – Jugend_I_weibl.

StandNr: 105

Unterpertinger,, Lea #70401047

StartNr: 99

11. Maerz 2017 11:06

SG_Angerberg

Ergebnis: **0.0** (0)_{DNS}

Serien:

Zaehler: 0 0 0 0 0 0 0 0 0 0

Innenzehner: 0

weiteste:

~~beste Teiler~~ – Schütze ist nicht zum Wettkampf angetreten

Trefferlage 0.00 mm , 0.00 mm

Streuwert

Unterschrift des Schuetzen

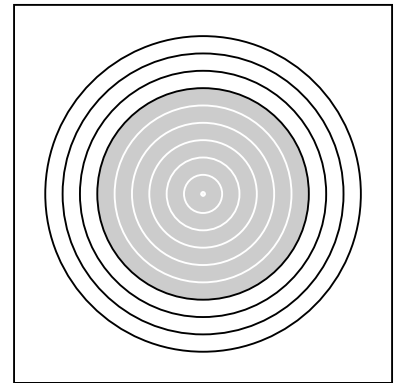

Ergebnis: **174.7** (166)
 Serien: 88.2 86.5
 Zaehler: 5 5 4 5 0 0 1 0 0 0
 Innenzehner: 3
 weiteste: 1550 (11), 955 (19), 855 (10)
 beste Teiler 157.1 (7.) 186.5 (14.) 193.0 (2.)
 Trefferlage 0.45 mm rechts, 1.60 mm hoch
 Streuwert 4.57, horizontal: 5.98, vertikal: 2.45

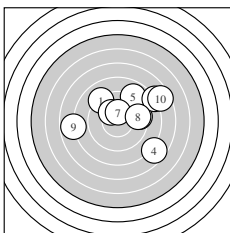
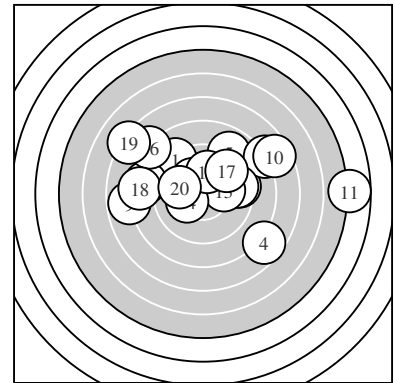

Serie 1:
 9.1 ↘ 10.2 * 9.4 → 7.6 ↘ 8.9 ↗
 7.9 ↗ 10.3 * 9.5 → 7.8 ← 7.5 ↗
 beste Teiler 157.1 (7.) 193.0 (2.) 368.3 (8.)
 Trefferlage 1.89 mm rechts, 1.45 mm hoch
 Streuwert 4.00, horizontal: 4.85, vertikal: 2.91

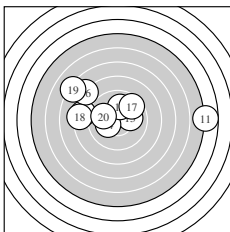

Serie 2:
 4.8 → 8.5 ← 10.1 → 10.2 * 10.0 ↑
 8.0 ↘ 9.6 ↗ 8.3 ← 7.1 ↘ 9.9 ←
 beste Teiler 186.5 (14.) 224.4 (13.) 237.1 (15.)
 Trefferlage 0.98 mm links, 1.75 mm hoch
 Streuwert 5.08, horizontal: 6.89, vertikal: 2.04

Unterschrift des Schuetzen

Ergebnis: **195.0** (187)
 Serien: 97.6 97.4
 Zaehler: 8 11 1 0 0 0 0 0 0 0
 Innenzehner: 5
 weiteste: 634 (8), 499 (15), 485 (14)
 beste Teiler 66.3 (12.) 129.2 (9.) 191.1 (13.)
 Trefferlage 0.49 mm rechts, 0.43 mm hoch
 Streuwert 2.34, horizontal: 2.84, vertikal: 1.69

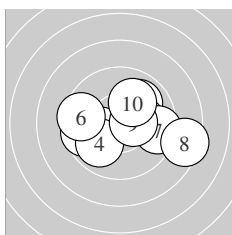
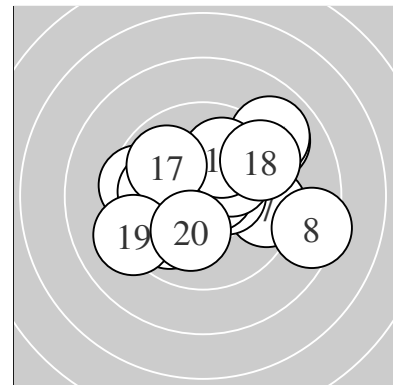

Serie 1:
 10.2 * 9.6 ← 9.9 ↗ 9.9 ↘ 10.2 *
 9.5 ← 9.5 → 8.4 → 10.4 * 10.0 ↗
 beste Teiler 129.2 (9.) 193.3 (5.) 199.4 (1.)
 Trefferlage 0.52 mm rechts, 0.10 mm tief
 Streuwert 2.39, horizontal: 3.12, vertikal: 1.32

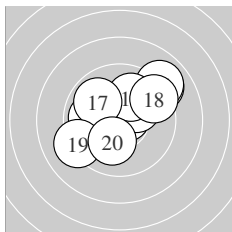

Serie 2:
 9.9 ← 10.7 * 10.2 * 9.0 ↗ 9.0 ↗
 10.0 ↗ 9.9 ↘ 9.4 ↗ 9.2 ← 10.1 ↓
 beste Teiler 66.3 (12.) 191.1 (13.) 206.8 (20.)
 Trefferlage 0.47 mm rechts, 0.97 mm hoch
 Streuwert 2.34, horizontal: 2.71, vertikal: 1.90

Unterschrift des Schuetzen

Ergebnis: **184.7** (176)
 Serien: 90.1 94.6
 Zaehler: 7 6 5 1 0 1 0 0 0 0
 Innenzehner: 6
 weiteste: 1266 (10), 896 (8), 748 (15)
 beste Teiler 40.4 (12.) 106.8 (20.) 110.4 (2.)
 Trefferlage 2.03 mm links, 1.53 mm hoch
 Streuwert 3.34, horizontal: 4.29, vertikal: 1.99

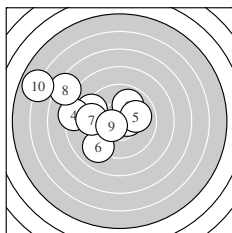
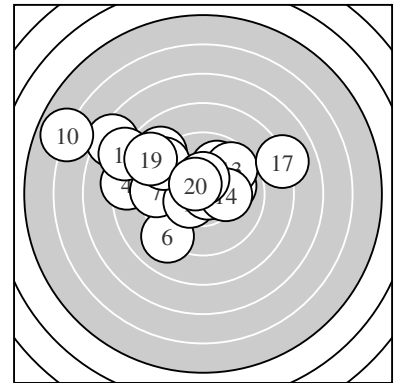

Serie 1:
 9.2 ↘ 10.5 * 9.9 ↗ 8.3 ← 10.0 →
 9.1 ↙ 9.4 ← 7.4 ↖ 10.4 * 5.9 ↖
 beste Teiler 110.4 (2.) 130.7 (9.) 239.8 (5.)
 Trefferlage 3.34 mm links, 1.11 mm hoch
 Streuwert 3.59, horizontal: 4.42, vertikal: 2.50

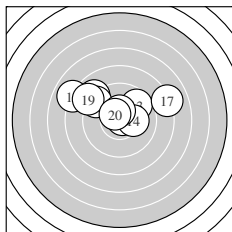

Serie 2:
 8.9 ↘ 10.8 * 9.7 ↗ 10.2 * 8.0 ↖
 9.3 ↘ 8.0 → 10.4 * 8.8 ↖ 10.5 *
 beste Teiler 40.4 (12.) 106.8 (20.) 133.0 (18.)
 Trefferlage 0.72 mm links, 1.95 mm hoch
 Streuwert 2.94, horizontal: 3.93, vertikal: 1.33

Unterschrift des Schuetzen

Ergebnis: **196.9** (189)
 Serien: 100.0 96.9
 Zaehler: 10 9 1 0 0 0 0 0 0 0
 Innenzehner: 6
 weiteste: 616 (16), 465 (15), 432 (5)
 beste Teiler 33.7 (10.) 87.0 (19.) 105.1 (12.)
 Trefferlage 1.07 mm links, 0.48 mm tief
 Streuwert 2.11, horizontal: 2.60, vertikal: 1.48

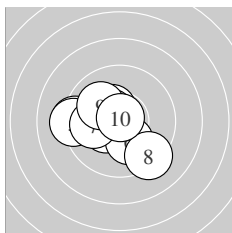
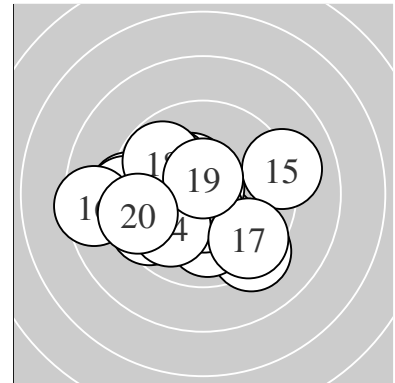

Serie 1:
 10.4 * 10.4 * 10.5 * 9.3 ← 9.2 ←
 10.1 ↓ 10.0 ← 9.3 ↘ 10.0 ↖ 10.8 *
 beste Teiler 33.7 (10.) 113.2 (3.) 138.5 (2.)
 Trefferlage 1.18 mm links, 0.23 mm tief
 Streuwert 1.83, horizontal: 2.16, vertikal: 1.42

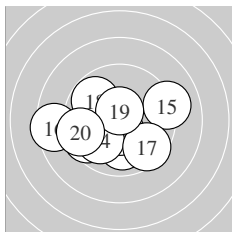

Serie 2:
 10.0 ↓ 10.5 * 9.6 ↙ 9.9 ↗ 9.1 →
 8.5 ← 9.5 ↘ 9.8 ↖ 10.6 * 9.4 ←
 beste Teiler 87.0 (19.) 105.1 (12.) 243.3 (11.)
 Trefferlage 0.96 mm links, 0.72 mm tief
 Streuwert 2.45, horizontal: 3.09, vertikal: 1.57

Unterschrift des Schuetzen

Ergebnis: **201.3** (193)
 Serien: 100.7 100.6
 Zaehler: 14 5 1 0 0 0 0 0 0 0
 Innenzehner: 10
 weiteste: 552 (9), 471 (17), 449 (18)
 beste Teiler 49.6 (3.) 78.4 (6.) 83.0 (16.)
 Trefferlage 0.11 mm links, 0.26 mm hoch
 Streuwert 1.85, horizontal: 2.25, vertikal: 1.34

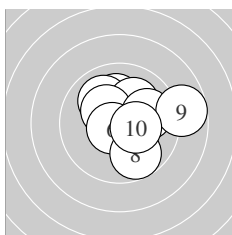
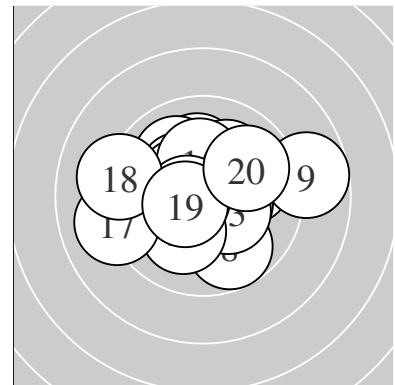

Serie 1:
 10.1 ↑ 10.0 ↘ 10.8 * 10.1 ↗ 10.3 *
 10.6 * 9.9 → 9.8 ↘ 8.7 → 10.4 *
 beste Teiler 49.6 (3.) 78.4 (6.) 146.7 (10.)
 Trefferlage 0.84 mm rechts, 0.57 mm hoch
 Streuwert 1.76, horizontal: 2.04, vertikal: 1.43

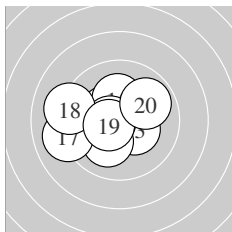

Serie 2:
 10.3 * 10.4 * 10.3 * 10.1 ✓ 10.2 *
 10.6 * 9.1 ← 9.2 ← 10.5 * 9.9 ↗
 beste Teiler 83.0 (16.) 103.7 (19.) 140.9 (12.)
 Trefferlage 1.07 mm links, 0.04 mm tief
 Streuwert 1.74, horizontal: 2.12, vertikal: 1.24

Unterschrift des Schuetzen

Ergebnis: **193.0** (184)
 Serien: 96.5 96.5
 Zaehler: 9 6 5 0 0 0 0 0 0 0
 Innenzehner: 5
 weiteste: 730 (8), 640 (13), 635 (18)
 beste Teiler 70.1 (17.) 117.6 (20.) 123.1 (19.)
 Trefferlage 0.61 mm links, 0.37 mm hoch
 Streuwert 2.67, horizontal: 3.53, vertikal: 1.33

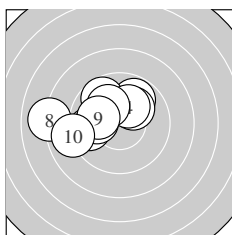
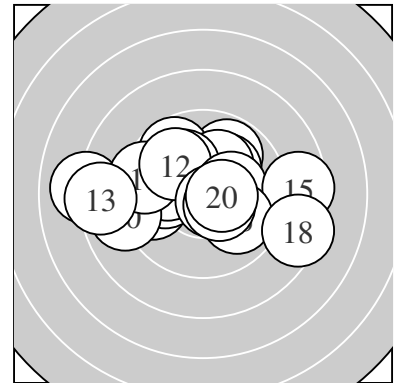

Serie 1:
 9.8 ↗ 9.7 ↘ 10.1 ↗ 10.2 * 10.1 ↘
 9.7 ← 10.0 ← 8.0 ← 10.0 ← 8.9 ←
 beste Teiler 197.7 (4.) 207.3 (3.) 213.8 (5.)
 Trefferlage 1.90 mm links, 0.91 mm hoch
 Streuwert 2.18, horizontal: 2.80, vertikal: 1.29

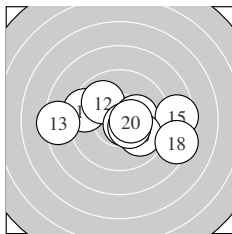

Serie 2:
 9.4 ← 9.9 ↘ 8.4 ← 10.2 * 8.6 →
 9.9 ↘ 10.7 * 8.4 → 10.5 * 10.5 *
 beste Teiler 70.1 (17.) 117.6 (20.) 123.1 (19.)
 Trefferlage 0.67 mm rechts, 0.16 mm tief
 Streuwert 2.85, horizontal: 3.85, vertikal: 1.19

Unterschrift des Schuetzen

Ergebnis: **186.3** (175)
 Serien: 95.0 91.3
 Zaehler: 6 7 3 4 0 0 0 0 0 0
 Innenzehner: 5
 weiteste: 844 (15), 830 (14), 802 (10)
 beste Teiler 18.0 (7.) 50.5 (11.) 90.8 (16.)
 Trefferlage 2.30 mm rechts, 0.84 mm hoch
 Streuwert 3.05, horizontal: 4.00, vertikal: 1.60

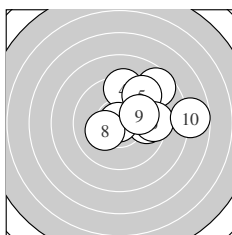
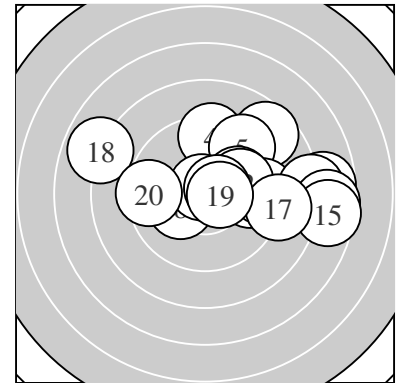

Serie 1:
 9.7 ↗ 8.7 ↗ 9.7 → 9.4 ↑ 9.3 ↗
 9.4 → 10.9 * 10.2 * 10.0 ↗ 7.7 →
 beste Teiler 18.0 (7.) 185.1 (8.) 242.6 (9.)
 Trefferlage 2.41 mm rechts, 1.46 mm hoch
 Streuwert 2.27, horizontal: 2.67, vertikal: 1.79

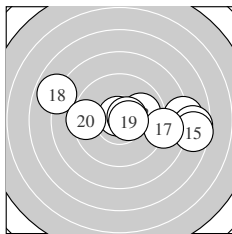

Serie 2:
 10.8 * 9.9 → 8.1 → 7.6 → 7.6 →
 10.6 * 8.9 → 7.9 ↖ 10.5 * 9.4 ←
 beste Teiler 50.5 (11.) 90.8 (16.) 101.1 (19.)
 Trefferlage 2.18 mm rechts, 0.22 mm hoch
 Streuwert 3.74, horizontal: 5.16, vertikal: 1.17

Unterschrift des Schuetzen

Ergebnis: **202.0** (193)
 Serien: 99.6 102.4
 Zaehler: 13 7 0 0 0 0 0 0 0 0
 Innenzehner: 9
 weiteste: 364 (16), 362 (4), 318 (1)
 beste Teiler 73.0 (18.) 96.4 (14.) 107.2 (20.)
 Trefferlage 0.66 mm links, 1.39 mm hoch
 Streuwert 1.24, horizontal: 1.49, vertikal: 0.93

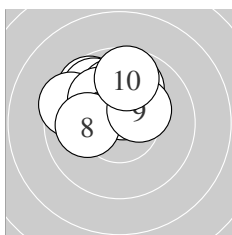
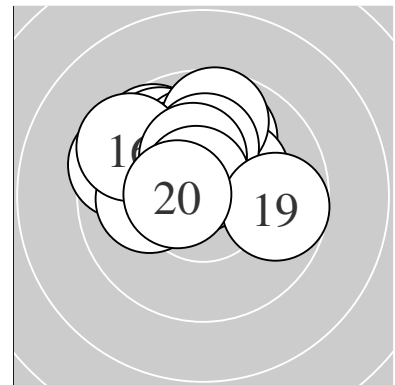

Serie 1:
 9.7 ↘ 9.8 ↘ 10.0 ↑ 9.5 ↖ 10.5 *
 9.9 ↑ 10.1 ↘ 10.1 ← 10.3 * 9.7 ↑
 beste Teiler 111.4 (5.) 164.7 (9.) 214.4 (7.)
 Trefferlage 0.84 mm links, 1.72 mm hoch
 Streuwert 1.29, horizontal: 1.56, vertikal: 0.95

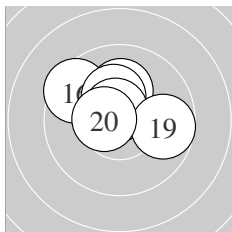

Serie 2:
 10.4 * 10.1 ↑ 10.3 * 10.6 * 10.3 *
 9.5 ↘ 10.3 * 10.7 * 9.7 → 10.5 *
 beste Teiler 73.0 (18.) 96.4 (14.) 107.2 (20.)
 Trefferlage 0.48 mm links, 1.06 mm hoch
 Streuwert 1.20, horizontal: 1.49, vertikal: 0.82

Unterschrift des Schuetzen

Ergebnis: **205.4** (198)
 Serien: 104.9 100.5
 Zaehler: 18 2 0 0 0 0 0 0 0 0
 Innenzehner: 15
 weiteste: 490 (11), 486 (20), 243 (16)
 beste Teiler 21.9 (1.) 79.8 (5.) 88.8 (8.)
 Trefferlage 0.21 mm links, 0.23 mm hoch
 Streuwert 1.50, horizontal: 1.96, vertikal: 0.82

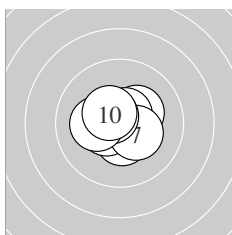
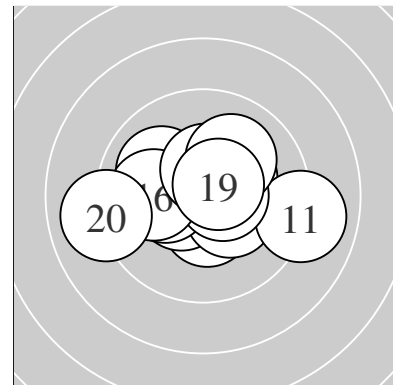

Serie 1:
 10.9 * 10.3 * 10.5 * 10.5 * 10.6 *
 10.5 * 10.3 * 10.6 * 10.2 * 10.5 *
 beste Teiler 21.9 (1.) 79.8 (5.) 88.8 (8.)
 Trefferlage 0.18 mm links, 0.06 mm hoch
 Streuwert 0.92, horizontal: 1.08, vertikal: 0.72

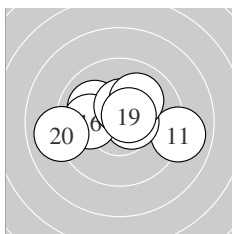

Serie 2:
 9.0 → 10.2 * 10.0 ↖ 10.6 * 10.6 *
 10.0 ← 10.4 * 10.1 ↗ 10.6 * 9.0 ←
 beste Teiler 92.8 (14.) 94.2 (19.) 98.0 (15.)
 Trefferlage 0.23 mm links, 0.41 mm hoch
 Streuwert 1.98, horizontal: 2.64, vertikal: 0.92

Unterschrift des Schuetzen

Ergebnis: **177.1** (167)
 Serien: 87.5 89.6
 Zaehler: 2 9 5 3 0 1 0 0 0 0
 Innenzehner: 2
 weiteste: 1339 (17), 952 (8), 831 (4)
 beste Teiler 111.8 (13.) 121.4 (5.) 284.7 (10.)
 Trefferlage 2.19 mm links, 1.97 mm hoch
 Streuwert 3.78, horizontal: 4.98, vertikal: 1.96

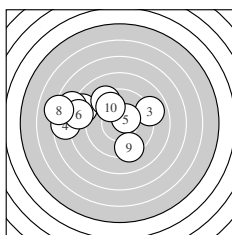
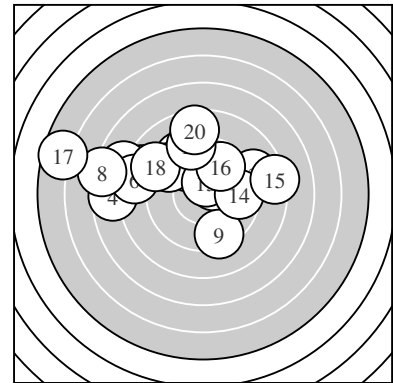

Serie 1:
 8.5 ↙ 7.9 ↙ 9.0 → 7.6 ← 10.5 *
 8.4 ← 9.3 ↘ 7.1 ← 9.4 ↓ 9.8 ↘
 beste Teiler 121.4 (5.) 284.7 (10.) 398.1 (9.)
 Trefferlage 3.34 mm links, 1.28 mm hoch
 Streuwert 3.63, horizontal: 4.72, vertikal: 2.03

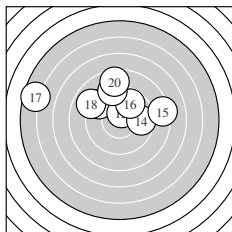

Serie 2:
 9.8 ↑ 9.4 ↘ 10.5 * 9.6 → 8.3 →
 9.8 ↗ 5.6 ← 8.9 ↘ 9.1 ↑ 8.6 ↑
 beste Teiler 111.8 (13.) 285.0 (11.) 300.4 (16.)
 Trefferlage 1.05 mm links, 2.66 mm hoch
 Streuwert 3.88, horizontal: 5.21, vertikal: 1.71

Unterschrift des Schuetzen

Ergebnis: **194.7** (189)
 Serien: 98.0 96.7
 Zaehler: 10 9 1 0 0 0 0 0 0 0
 Innenzehner: 3
 weiteste: 669 (12), 456 (20), 453 (3)
 beste Teiler 132.3 (14.) 132.6 (6.) 168.7 (7.)
 Trefferlage 0.55 mm links, 0.71 mm hoch
 Streuwert 2.29, horizontal: 2.92, vertikal: 1.40

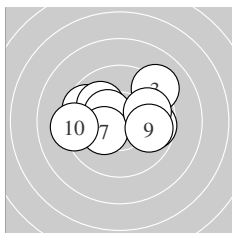
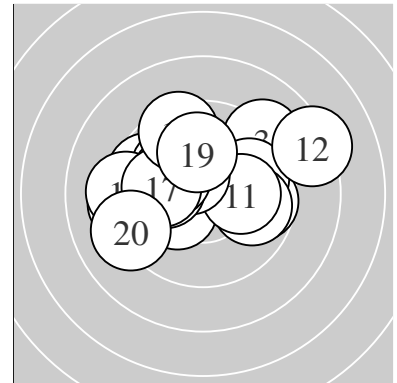

Serie 1:
 9.6 ↖ 9.7 → 9.1 ↗ 10.0 ← 10.0 ↘
 10.4 * 10.3 * 9.9 → 9.8 → 9.2 ←
 beste Teiler 132.6 (6.) 168.7 (7.) 233.0 (5.)
 Trefferlage 0.22 mm links, 0.49 mm hoch
 Streuwert 2.21, horizontal: 2.88, vertikal: 1.22

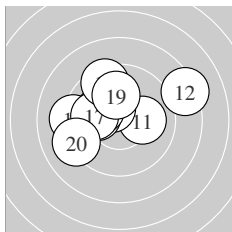

Serie 2:
 10.1 → 8.3 ↗ 9.2 ← 10.4 * 10.1 ←
 10.1 ↖ 10.0 ← 9.4 ↘ 10.0 ↑ 9.1 ←
 beste Teiler 132.3 (14.) 203.1 (16.) 213.0 (11.)
 Trefferlage 0.88 mm links, 0.93 mm hoch
 Streuwert 2.45, horizontal: 3.08, vertikal: 1.59

Unterschrift des Schuetzen

Ergebnis: **165.0** (158)
 Serien: 86.5 78.5
 Zaehler: 4 5 4 1 5 0 1 0 0 0
 Innenzehner: 2
 weiteste: 1732 (14), 1229 (8), 1140 (13)
 beste Teiler 117.1 (6.) 124.5 (18.) 204.0 (11.)
 Trefferlage 0.69 mm links, 1.06 mm hoch
 Streuwert 5.74, horizontal: 7.56, vertikal: 2.97

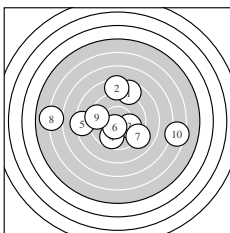
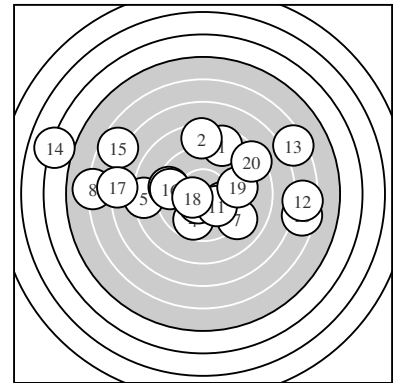

Serie 1:
 8.6 ↗ 8.5 ↑ 10.0 ↘ 9.7 ↓ 8.3 ←
 10.5 * 9.1 ↘ 6.0 ← 9.4 ← 6.4 →
 beste Teiler 117.1 (6.) 237.1 (3.) 304.4 (4.)
 Trefferlage 0.53 mm links, 0.24 mm hoch
 Streuwert 4.96, horizontal: 6.26, vertikal: 3.18

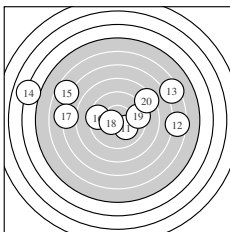

Serie 2:
 10.1 ↘ 6.5 → 6.4 ↗ 4.0 ← 6.6 ↖
 9.5 ← 7.1 ← 10.5 * 9.4 → 8.4 ↗
 beste Teiler 124.5 (18.) 204.0 (11.) 370.9 (16.)
 Trefferlage 0.85 mm links, 1.87 mm hoch
 Streuwert 6.65, horizontal: 9.02, vertikal: 2.66

Unterschrift des Schuetzen