

Ergebnis: **183.5** (174)
 Serien: 90.2 93.3
 Zähler: 5 6 7 2 0 0 0 0 0 0
 Innenzehner: 4
 weiteste: 980 (8), 804 (16), 686 (4)
 beste Teiler 72.1 (17.) 103.5 (15.) 107.5 (11.)
 Trefferlage 0.81 mm links, 1.80 mm hoch
 Streuwert 3.40, horizontal: 4.49, vertikal: 1.71

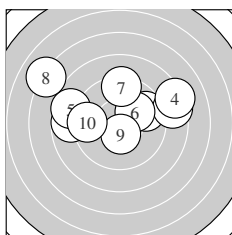

Serie 1:
 9.7 ↗ 8.8 ← 8.5 ↗ 8.2 ↗ 8.6 ↖
 10.1 ↗ 9.3 ↑ 7.0 ↘ 10.5 * 9.5 ←
 beste Teiler 124.5 (9.) 215.2 (6.) 324.9 (1.)
 Trefferlage 0.57 mm links, 1.70 mm hoch
 Streuwert 3.80, horizontal: 5.02, vertikal: 1.93

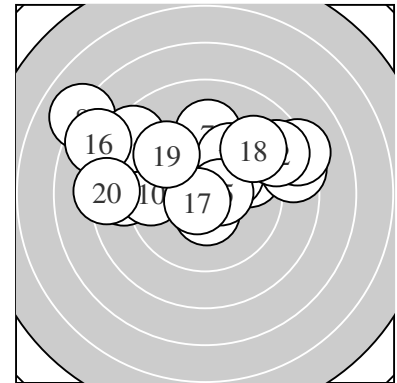
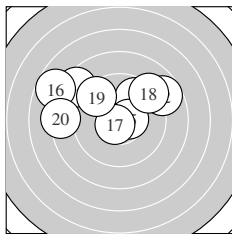

Serie 2:
 10.5 * 8.7 ↗ 9.7 ↗ 8.5 ↘ 10.5 *
 7.7 ↘ 10.7 * 9.2 ↗ 9.5 ↘ 8.3 ←
 beste Teiler 72.1 (17.) 103.5 (15.) 107.5 (11.)
 Trefferlage 1.06 mm links, 1.90 mm hoch
 Streuwert 3.13, horizontal: 4.15, vertikal: 1.55

Unterschrift des Schützen

Ergebnis: **199.2** (191)
 Serien: 100.8 98.4
 Zähler: 14 4 1 1 0 0 0 0 0 0
 Innenzehner: 9
 weiteste: 819 (15), 501 (16), 429 (14)
 beste Teiler 56.4 (11.) 72.3 (12.) 113.2 (4.)
 Trefferlage 0.12 mm rechts, 0.16 mm hoch
 Streuwert 2.18, horizontal: 2.88, vertikal: 1.10

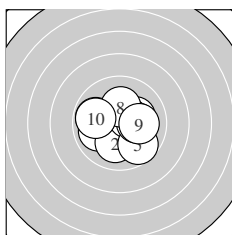
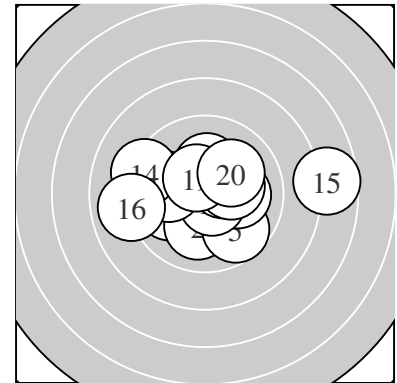

Serie 1:
 10.0 ← 10.1 ↓ 10.2 * 10.5 * 9.7 ↘
 9.9 ← 10.2 * 10.2 * 10.1 → 9.9 ←
 beste Teiler 113.2 (4.) 182.3 (8.) 188.8 (3.)
 Trefferlage 0.07 mm rechts, 0.11 mm tief
 Streuwert 1.70, horizontal: 2.01, vertikal: 1.32

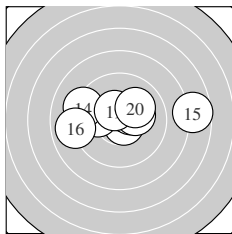

Serie 2:
 10.7 * 10.7 * 10.0 ← 9.2 ↖ 7.7 →
 8.9 ← 10.4 * 10.2 * 10.5 * 10.1 ↗
 beste Teiler 56.4 (11.) 72.3 (12.) 121.2 (19.)
 Trefferlage 0.17 mm rechts, 0.44 mm hoch
 Streuwert 2.65, horizontal: 3.67, vertikal: 0.81

Unterschrift des Schützen

Ergebnis: **191.6** (183)
 Serien: 95.2 96.4
 Zähler: 10 5 3 2 0 0 0 0 0 0
 Innenzehner: 7
 weiteste: 905 (6), 813 (19), 688 (13)
 beste Teiler 51.8 (4.) 81.3 (10.) 92.5 (12.)
 Trefferlage 0.19 mm rechts, 0.24 mm hoch
 Streuwert 3.03, horizontal: 4.09, vertikal: 1.27

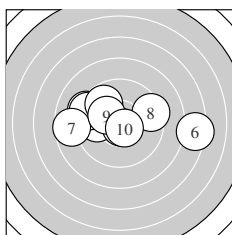
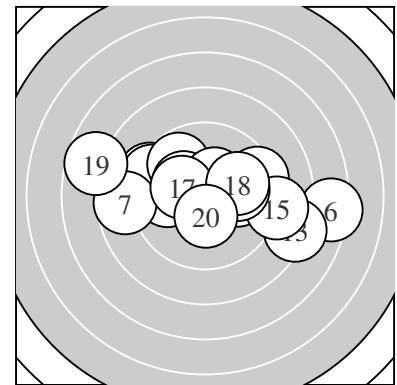

Serie 1:
 9.9 ← 9.3 ↖ 9.3 ↖ 10.7 * 9.8 ↖
 7.3 → 8.7 ← 9.4 → 10.2 * 10.6 *
 beste Teiler 51.8 (4.) 81.3 (10.) 180.0 (9.)
 Trefferlage 0.60 mm links, 0.49 mm hoch
 Streuwert 3.15, horizontal: 4.31, vertikal: 1.13

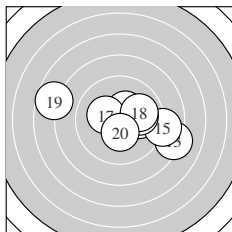

Serie 2:
 10.0 → 10.6 * 8.2 ↘ 10.4 * 8.9 →
 10.0 → 10.2 * 10.0 → 7.7 ← 10.4 *
 beste Teiler 92.5 (12.) 139.6 (14.) 145.1 (20.)
 Trefferlage 0.99 mm rechts, 0.01 mm tief
 Streuwert 2.94, horizontal: 3.92, vertikal: 1.41

Unterschrift des Schützen

Ergebnis: **180.2** (174)
 Serien: 88.9 91.3
 Zähler: 4 8 6 2 0 0 0 0 0 0
 Innenzehner: 3
 weiteste: 874 (2), 832 (9), 746 (15)
 beste Teiler 146.4 (7.) 152.0 (19.) 184.8 (5.)
 Trefferlage 1.34 mm links, 1.18 mm tief
 Streuwert 3.68, horizontal: 4.81, vertikal: 2.00

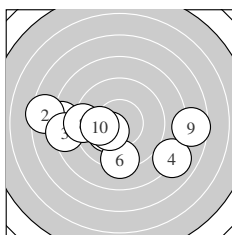
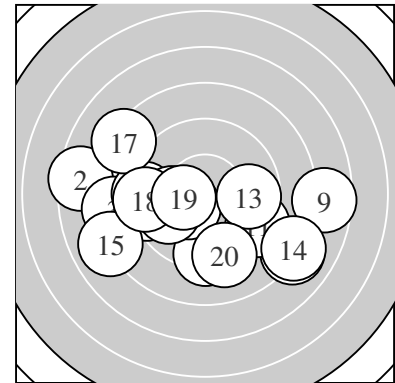

Serie 1:
 8.3 ← 7.5 ← 8.4 ← 8.0 ↘ 10.2 *
 9.3 ↓ 10.4 * 9.2 ← 7.6 → 10.0 ←
 beste Teiler 146.4 (7.) 184.8 (5.) 234.0 (10.)
 Trefferlage 1.65 mm links, 1.06 mm tief
 Streuwert 4.04, horizontal: 5.45, vertikal: 1.74

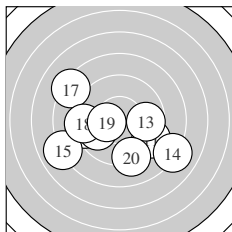

Serie 2:
 9.3 ↘ 9.3 ← 9.7 → 8.1 ↘ 8.0 ←
 9.8 ← 8.3 ↘ 9.3 ← 10.3 * 9.2 ↓
 beste Teiler 152.0 (19.) 283.1 (16.) 305.5 (13.)
 Trefferlage 1.03 mm links, 1.31 mm tief
 Streuwert 3.49, horizontal: 4.35, vertikal: 2.32

Unterschrift des Schützen

Ergebnis: **192.4** (182)
 Serien: 92.2 100.2
 Zähler: 7 10 1 2 0 0 0 0 0 0
 Innenzehner: 5
 weiteste: 942 (10), 842 (5), 594 (1)
 beste Teiler 64.8 (15.) 82.4 (16.) 148.5 (3.)
 Trefferlage 0.93 mm rechts, 0.68 mm tief
 Streuwert 2.77, horizontal: 3.62, vertikal: 1.50

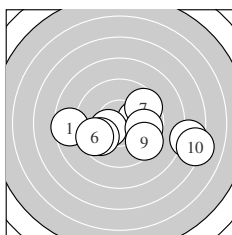
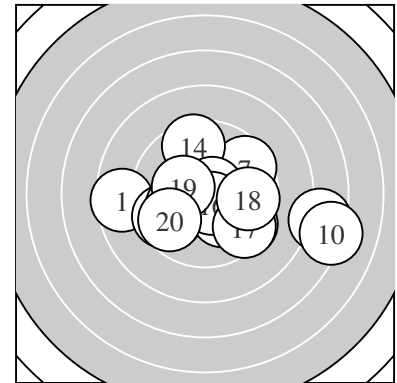

Serie 1:
 8.6 ← 10.1 → 10.4 * 9.8 ↙ 7.6 →
 9.6 ↙ 9.6 ↗ 9.8 → 9.5 ↘ 7.2 →
 beste Teiler 148.5 (3.) 204.9 (2.) 280.1 (4.)
 Trefferlage 1.53 mm rechts, 0.93 mm tief
 Streuwert 3.51, horizontal: 4.77, vertikal: 1.38

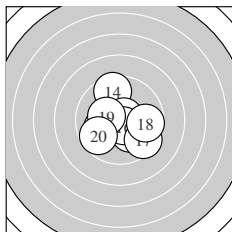

Serie 2:
 10.2 * 9.9 ↘ 10.1 ↙ 9.5 ↑ 10.7 *
 10.6 * 9.5 ↘ 9.7 → 10.3 * 9.7 ↙
 beste Teiler 64.8 (15.) 82.4 (16.) 163.2 (19.)
 Trefferlage 0.34 mm rechts, 0.44 mm tief
 Streuwert 1.84, horizontal: 2.02, vertikal: 1.64

Unterschrift des Schützen

Ergebnis: **200.5** (192)
 Serien: 101.5 99.0
 Zähler: 13 6 1 0 0 0 0 0 0 0
 Innenzehner: 11
 weiteste: 705 (18), 379 (11), 374 (13)
 beste Teiler 53.2 (17.) 87.8 (12.) 124.3 (16.)
 Trefferlage 0.70 mm rechts, 0.58 mm tief
 Streuwert 1.85, horizontal: 2.49, vertikal: 0.80

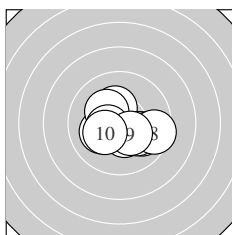
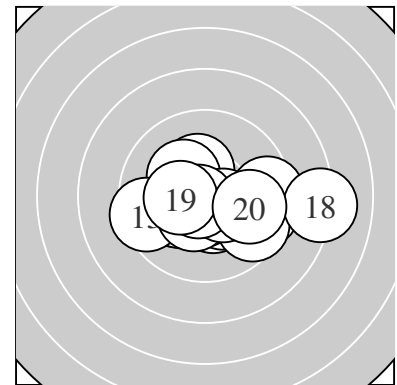

Serie 1:
 10.3 * 10.1 ← 10.2 * 10.4 * 9.9 ↘
 10.4 * 10.1 ↘ 9.5 → 10.4 * 10.2 *
 beste Teiler 126.1 (6.) 133.7 (4.) 149.9 (9.)
 Trefferlage 0.28 mm rechts, 0.47 mm tief
 Streuwert 1.48, horizontal: 1.84, vertikal: 1.00

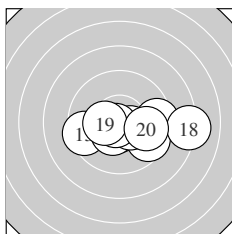

Serie 2:
 9.4 → 10.6 * 9.5 ← 10.4 * 9.6 ↘
 10.5 * 10.7 * 8.1 → 10.4 * 9.8 →
 beste Teiler 53.2 (17.) 87.8 (12.) 124.3 (16.)
 Trefferlage 1.12 mm rechts, 0.69 mm tief
 Streuwert 2.19, horizontal: 3.05, vertikal: 0.55

Unterschrift des Schützen

Ergebnis: **204.6** (195)
 Serien: 101.2 103.4
 Zähler: 16 3 1 0 0 0 0 0 0 0
 Innenzehner: 12
 weiteste: 541 (8), 288 (19), 259 (5)
 beste Teiler 27.7 (6.) 59.6 (13.) 63.2 (14.)
 Trefferlage 0.33 mm rechts, 0.08 mm hoch
 Streuwert 1.51, horizontal: 2.01, vertikal: 0.72

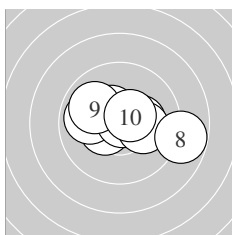
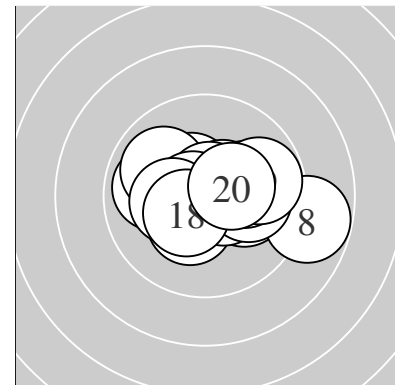

Serie 1:
 10.5 * 10.3 * 10.0 ← 10.4 * 9.9 ←
 10.8 * 10.1 → 8.8 → 9.9 ↖ 10.5 *
 beste Teiler 27.7 (6.) 111.8 (10.) 124.8 (1.)
 Trefferlage 0.11 mm rechts, 0.22 mm hoch
 Streuwert 1.82, horizontal: 2.46, vertikal: 0.76

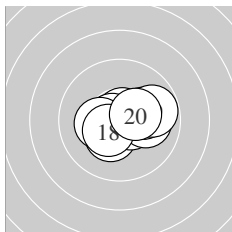

Serie 2:
 10.3 * 10.6 * 10.7 * 10.7 * 10.1 →
 10.1 → 10.3 * 10.4 * 9.8 → 10.4 *
 beste Teiler 59.6 (13.) 63.2 (14.) 100.2 (12.)
 Trefferlage 0.55 mm rechts, 0.04 mm tief
 Streuwert 1.19, horizontal: 1.54, vertikal: 0.69

Unterschrift des Schützen

Ergebnis: **202.1** (192)
 Serien: 101.7 100.4
 Zähler: 12 8 0 0 0 0 0 0 0 0
 Innenzehner: 11
 weiteste: 411 (15), 367 (6), 349 (18)
 beste Teiler 94.8 (8.) 99.3 (9.) 113.9 (12.)
 Trefferlage 0.07 mm links, 0.12 mm tief
 Streuwert 1.72, horizontal: 2.32, vertikal: 0.72

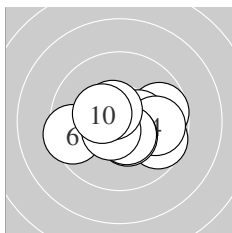
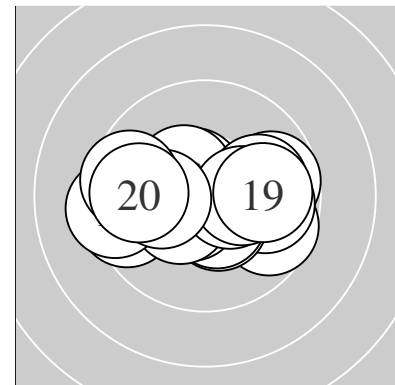

Serie 1:
 9.7 → 10.4 * 9.7 ↘ 9.9 → 10.4 *
 9.5 ← 10.5 * 10.6 * 10.6 * 10.4 *
 beste Teiler 94.8 (8.) 99.3 (9.) 117.1 (7.)
 Trefferlage 0.51 mm rechts, 0.33 mm tief
 Streuwert 1.60, horizontal: 2.10, vertikal: 0.83

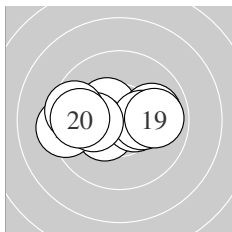

Serie 2:
 10.4 * 10.5 * 10.4 * 10.0 → 9.3 ←
 10.3 * 10.2 * 9.6 ← 9.9 → 9.8 ←
 beste Teiler 113.9 (12.) 135.7 (13.) 140.0 (11.)
 Trefferlage 0.67 mm links, 0.08 mm hoch
 Streuwert 1.80, horizontal: 2.49, vertikal: 0.56

Unterschrift des Schützen

Ergebnis: **200.6** (191)
 Serien: 98.8 101.8
 Zähler: 13 6 0 1 0 0 0 0 0 0
 Innenzehner: 11
 weiteste: 822 (1), 412 (13), 360 (3)
 beste Teiler 6.3 (4.) 63.1 (9.) 74.3 (2.)
 Trefferlage 1.07 mm links, 0.75 mm hoch
 Streuwert 1.89, horizontal: 2.50, vertikal: 0.94

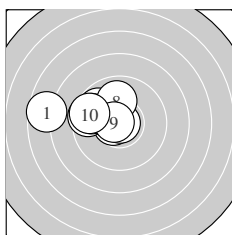
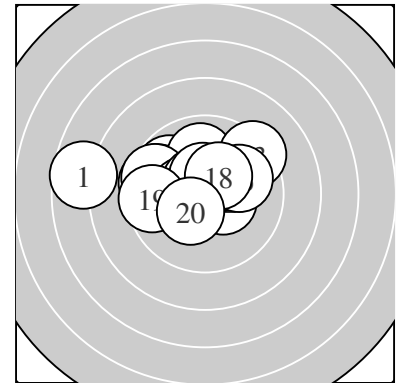

Serie 1:
 7.7 ← 10.7 * 9.5 ← 10.9 * 9.8 ↖
 9.6 ← 10.4 * 10.0 ↑ 10.7 * 9.5 ←
 beste Teiler 6.3 (4.) 63.1 (9.) 74.3 (2.)
 Trefferlage 2.33 mm links, 0.89 mm hoch
 Streuwert 1.81, horizontal: 2.43, vertikal: 0.82

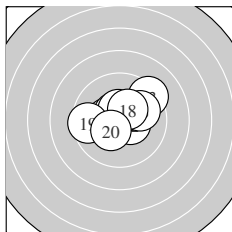

Serie 2:
 10.4 * 10.4 * 9.3 ↗ 10.5 * 10.4 *
 10.0 → 10.5 * 10.4 * 9.5 ← 10.4 *
 beste Teiler 102.4 (14.) 118.0 (17.) 129.8 (12.)
 Trefferlage 0.18 mm rechts, 0.62 mm hoch
 Streuwert 1.57, horizontal: 1.94, vertikal: 1.08

Unterschrift des Schützen

Ergebnis: **173.0** (164)
 Serien: 93.1 79.9
 Zähler: 2 10 4 1 1 1 1 0 0 0
 Innenzehner: 2
 weiteste: 1512 (12), 1426 (15), 1012 (5)
 beste Teiler 130.1 (4.) 133.5 (2.) 254.4 (1.)
 Trefferlage 2.11 mm links, 0.41 mm tief
 Streuwert 4.67, horizontal: 5.60, vertikal: 3.51

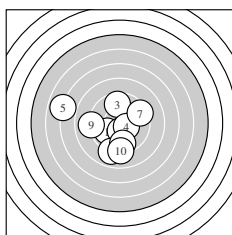
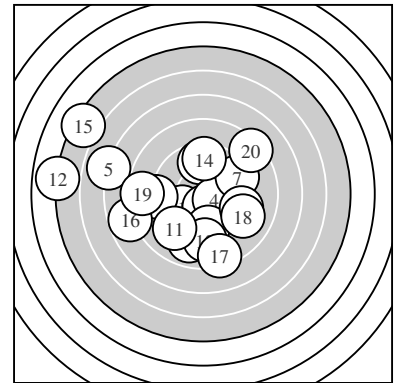

Serie 1:
 9.9 ↙ 10.4 * 9.6 ↑ 10.4 * 6.9 ←
 8.9 ↓ 9.4 → 9.6 ↓ 9.0 ← 9.0 ↓
 beste Teiler 130.1 (4.) 133.5 (2.) 254.4 (1.)
 Trefferlage 1.30 mm links, 0.89 mm tief
 Streuwert 3.32, horizontal: 3.70, vertikal: 2.89

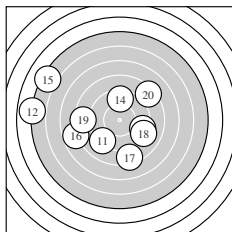

Serie 2:
 9.1 ↙ 4.9 ← 9.3 → 9.5 ↑ 5.2 ↘
 7.8 ← 8.3 ↓ 9.1 → 8.4 ← 8.3 ↗
 beste Teiler 365.1 (14.) 422.6 (13.) 460.9 (11.)
 Trefferlage 2.93 mm links, 0.05 mm hoch
 Streuwert 5.84, horizontal: 7.14, vertikal: 4.14

Unterschrift des Schützen

Ergebnis: **197.2** (188)
 Serien: 100.3 96.9
 Zähler: 11 7 1 1 0 0 0 0 0 0
 Innenzehner: 9
 weiteste: 913 (13), 602 (12), 344 (6)
 beste Teiler 105.5 (14.) 106.6 (15.) 123.0 (18.)
 Trefferlage 0.96 mm links, 0.26 mm tief
 Streuwert 2.29, horizontal: 2.88, vertikal: 1.49

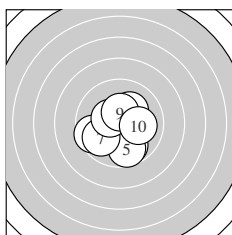
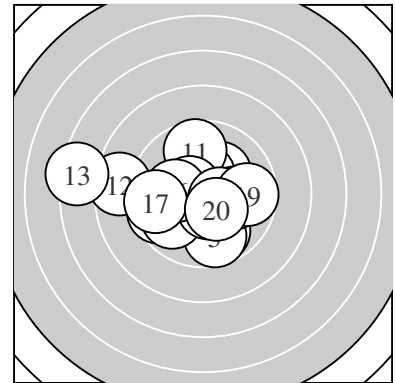

Serie 1:
 10.2 * 9.8 ↘ 10.0 ↙ 10.3 * 9.7 ↓
 9.6 ← 9.8 ↙ 10.4 * 10.4 * 10.1 →
 beste Teiler 130.1 (8.) 131.1 (9.) 163.6 (4.)
 Trefferlage 0.30 mm links, 0.81 mm tief
 Streuwert 1.67, horizontal: 1.78, vertikal: 1.56

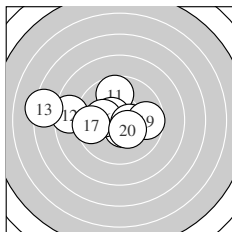

Serie 2:
 9.7 ↑ 8.5 ← 7.3 ← 10.5 * 10.5 *
 10.2 * 9.6 ← 10.5 * 9.7 → 10.4 *
 beste Teiler 105.5 (14.) 106.6 (15.) 123.0 (18.)
 Trefferlage 1.62 mm links, 0.28 mm hoch
 Streuwert 2.73, horizontal: 3.65, vertikal: 1.26

Unterschrift des Schützen

Ergebnis: **197.2** (188)
 Serien: 98.5 98.7
 Zähler: 10 8 2 0 0 0 0 0 0 0
 Innenzehner: 5
 weiteste: 522 (12), 502 (1), 471 (10)
 beste Teiler 24.5 (9.) 62.6 (4.) 114.4 (8.)
 Trefferlage 0.45 mm rechts, 0.38 mm tief
 Streuwert 2.22, horizontal: 2.44, vertikal: 1.97

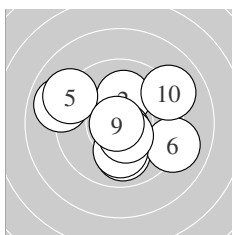
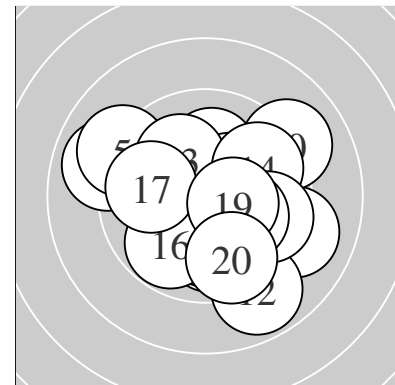

Serie 1:
 8.9 ↖ 10.1 ↑ 10.0 ↓ 10.7 * 9.1 ↗
 9.1 ↗ 10.1 ↓ 10.5 * 10.9 * 9.1 ↗
 beste Teiler 24.5 (9.) 62.6 (4.) 114.4 (8.)
 Trefferlage 0.07 mm rechts, 0.01 mm hoch
 Streuwert 2.45, horizontal: 2.88, vertikal: 1.93

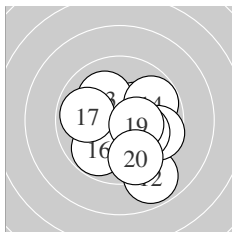

Serie 2:
 10.4 * 8.9 ↘ 10.1 ↖ 9.8 ↗ 9.7 ↗
 9.8 ↗ 9.9 ← 10.1 ↗ 10.4 * 9.6 ↘
 beste Teiler 141.6 (19.) 147.0 (11.) 212.0 (18.)
 Trefferlage 0.83 mm rechts, 0.78 mm tief
 Streuwert 2.01, horizontal: 1.99, vertikal: 2.04

Unterschrift des Schützen

Ergebnis: **0.0** (0)_{DNS}
Serien:
Zähler: 0 0 0 0 0 0 0 0 0 0
Innenzehner: 0
weiteste:
~~beste~~ Teiler – Schütze ist nicht zum Wettkampf angetreten
Trefferlage 0.00 mm , 0.00 mm
Streuwert
Unterschrift des Schützen

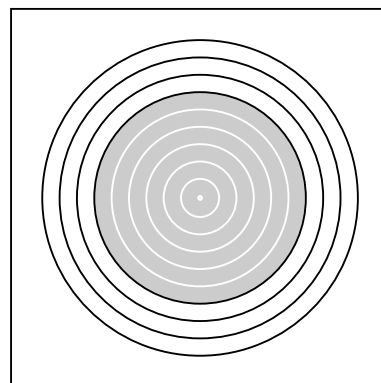

Meyton Elektronik

Ergebnis: **201.2** (195)
 Serien: 100.8 100.4
 Zähler: 15 5 0 0 0 0 0 0 0 0
 Innenzehner: 6
 weiteste: 454 (12), 394 (7), 334 (8)
 beste Teiler 43.4 (13.) 82.2 (6.) 124.4 (9.)
 Trefferlage 0.29 mm rechts, 0.50 mm tief
 Streuwert 1.71, horizontal: 2.20, vertikal: 1.01

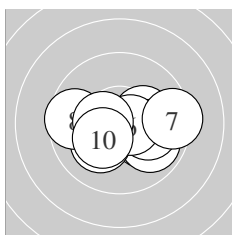
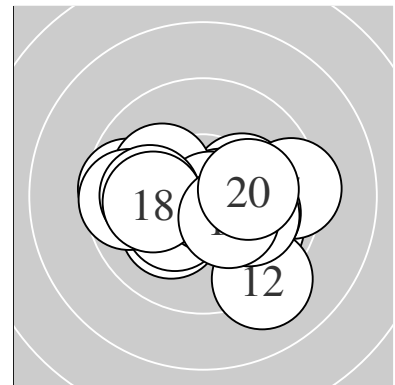

Serie 1:
 10.2 * 10.1 ↘ 9.9 ↘ 10.1 → 10.1 ↙
 10.6 * 9.4 → 9.6 ← 10.5 * 10.3 *
 beste Teiler 82.2 (6.) 124.4 (9.) 167.2 (10.)
 Trefferlage 0.53 mm rechts, 0.43 mm tief
 Streuwert 1.67, horizontal: 2.24, vertikal: 0.77

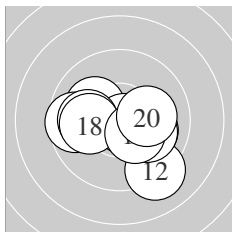

Serie 2:
 10.1 ↖ 9.1 ↘ 10.8 * 9.6 ← 10.1 →
 10.1 → 10.0 ← 10.1 ← 10.4 * 10.1 →
 beste Teiler 43.4 (13.) 150.4 (19.) 204.0 (20.)
 Trefferlage 0.05 mm rechts, 0.57 mm tief
 Streuwert 1.82, horizontal: 2.26, vertikal: 1.24

Unterschrift des Schützen

Ergebnis: **183.5** (174)
 Serien: 93.3 90.2
 Zähler: 3 10 5 2 0 0 0 0 0 0
 Innenzehner: 1
 weiteste: 844 (18), 794 (10), 675 (16)
 beste Teiler 102.8 (19.) 207.7 (8.) 214.2 (2.)
 Trefferlage 2.29 mm links, 2.25 mm tief
 Streuwert 2.63, horizontal: 3.30, vertikal: 1.73

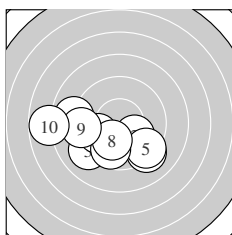
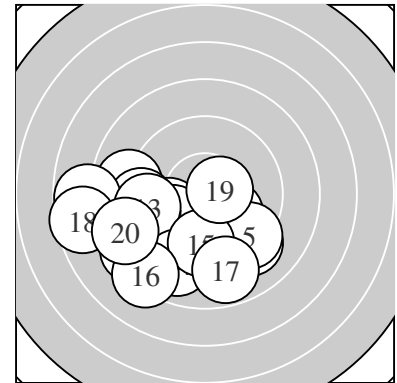

Serie 1:
 9.2 ↘ 10.1 ↘ 9.1 ↙ 9.9 ↙ 9.3 ↘
 9.7 ↓ 8.9 ← 10.1 ↓ 9.2 ← 7.8 ←
 beste Teiler 207.7 (8.) 214.2 (2.) 269.2 (4.)
 Trefferlage 1.75 mm links, 1.64 mm tief
 Streuwert 2.74, horizontal: 3.62, vertikal: 1.37

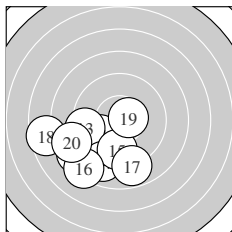

Serie 2:
 9.9 ↙ 8.5 ↙ 9.4 ← 9.0 ↓ 9.6 ↓
 8.3 ↙ 8.8 ↓ 7.6 ← 10.5 * 8.6 ←
 beste Teiler 102.8 (19.) 273.6 (11.) 332.0 (15.)
 Trefferlage 2.83 mm links, 2.87 mm tief
 Streuwert 2.53, horizontal: 3.04, vertikal: 1.90

Unterschrift des Schützen

Ergebnis: **184.3** (176)
 Serien: 91.6 92.7
 Zähler: 5 8 5 2 0 0 0 0 0 0
 Innenzehner: 4
 weiteste: 870 (4), 830 (13), 732 (11)
 beste Teiler 114.6 (15.) 158.7 (17.) 166.2 (19.)
 Trefferlage 0.54 mm rechts, 0.08 mm tief
 Streuwert 3.53, horizontal: 4.64, vertikal: 1.86

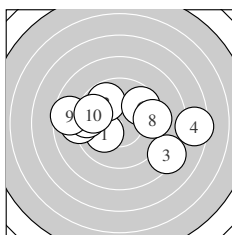
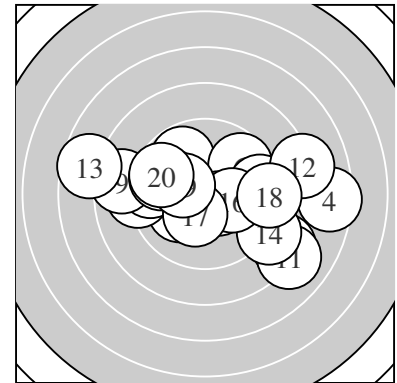

Serie 1:
 10.1 ↙ 9.8 ↖ 8.3 ↘ 7.5 → 9.1 ←
 9.7 ↗ 9.4 ← 9.4 → 8.6 ← 9.7 ↖
 beste Teiler 209.9 (1.) 291.8 (2.) 317.8 (6.)
 Trefferlage 0.02 mm links, 0.22 mm hoch
 Streuwert 3.64, horizontal: 4.85, vertikal: 1.72

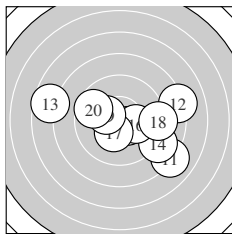

Serie 2:
 8.0 ↘ 8.1 → 7.6 ← 8.9 ↘ 10.5 *
 10.2 * 10.3 * 9.2 → 10.3 * 9.6 ↖
 beste Teiler 114.6 (15.) 158.7 (17.) 166.2 (19.)
 Trefferlage 1.10 mm rechts, 0.39 mm tief
 Streuwert 3.55, horizontal: 4.60, vertikal: 2.04

Unterschrift des Schützen

Ergebnis: **202.2** (192)
 Serien: 101.2 101.0
 Zähler: 12 8 0 0 0 0 0 0 0 0
 Innenzehner: 10
 weiteste: 396 (1), 380 (16), 358 (11)
 beste Teiler 65.7 (8.) 67.1 (18.) 79.0 (20.)
 Trefferlage 0.62 mm links, 0.27 mm hoch
 Streuwert 1.63, horizontal: 1.79, vertikal: 1.46

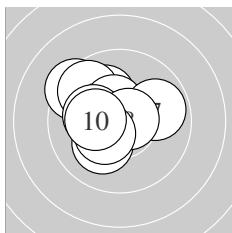
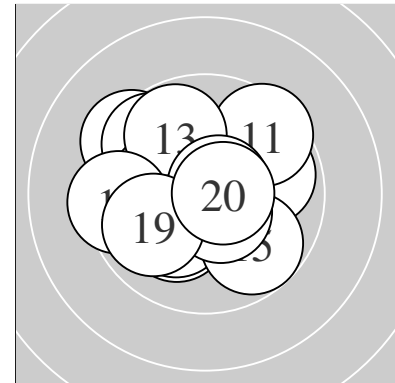

Serie 1:
 9.4 ↘ 10.1 ↘ 10.1 ↙ 9.7 ↘ 10.5 *
 10.2 * 9.9 → 10.7 * 10.4 * 10.2 *
 beste Teiler 65.7 (8.) 121.4 (5.) 141.2 (9.)
 Trefferlage 0.97 mm links, 0.65 mm hoch
 Streuwert 1.47, horizontal: 1.64, vertikal: 1.29

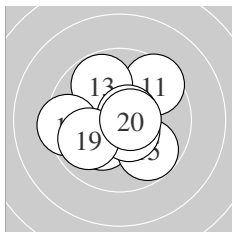

Serie 2:
 9.5 ↗ 10.6 * 9.8 ↘ 10.2 * 9.8 ↘
 9.4 ← 10.5 * 10.7 * 9.9 ↙ 10.6 *
 beste Teiler 67.1 (18.) 79.0 (20.) 89.5 (12.)
 Trefferlage 0.27 mm links, 0.10 mm tief
 Streuwert 1.78, horizontal: 1.96, vertikal: 1.59

Unterschrift des Schützen

Ergebnis: **204.9** (195)
 Serien: 103.3 101.6
 Zähler: 15 5 0 0 0 0 0 0 0 0
 Innenzehner: 11
 weiteste: 350 (12), 320 (9), 305 (14)
 beste Teiler 33.6 (2.) 39.6 (7.) 53.3 (4.)
 Trefferlage 0.49 mm links, 0.16 mm hoch
 Streuwert 1.40, horizontal: 1.58, vertikal: 1.19

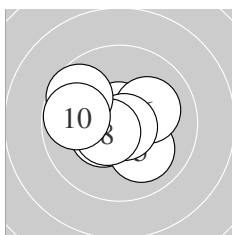
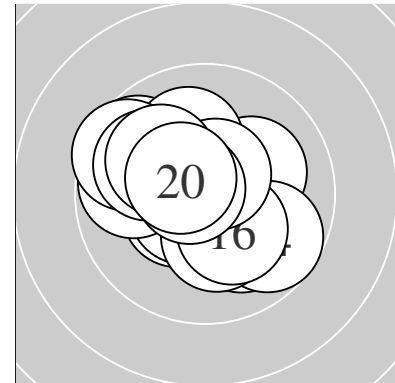

Serie 1:
 10.5 * 10.8 * 10.4 * 10.7 * 10.0 ↘
 10.1 ↗ 10.8 * 10.5 * 9.7 ↖ 9.8 ←
 beste Teiler 33.6 (2.) 39.6 (7.) 53.3 (4.)
 Trefferlage 0.49 mm links, 0.02 mm hoch
 Streuwert 1.30, horizontal: 1.57, vertikal: 0.96

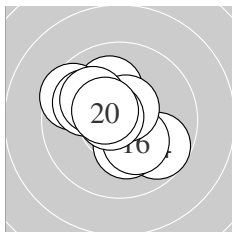

Serie 2:
 10.1 ↗ 9.6 ↖ 9.9 ↖ 9.7 ↘ 10.2 *
 10.2 * 10.6 * 10.1 ↖ 10.7 * 10.5 *
 beste Teiler 66.1 (19.) 89.4 (17.) 117.0 (20.)
 Trefferlage 0.49 mm links, 0.30 mm hoch
 Streuwert 1.55, horizontal: 1.68, vertikal: 1.41

Unterschrift des Schützen

Ergebnis: **184.6** (176)
 Serien: 90.2 94.4
 Zähler: 2 14 2 2 0 0 0 0 0 0
 Innenzehner: 2
 weiteste: 915 (7), 862 (6), 551 (19)
 beste Teiler 41.4 (15.) 163.0 (9.) 254.6 (17.)
 Trefferlage 0.05 mm links, 0.95 mm hoch
 Streuwert 3.36, horizontal: 4.55, vertikal: 1.38

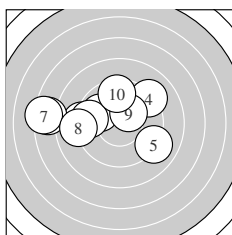
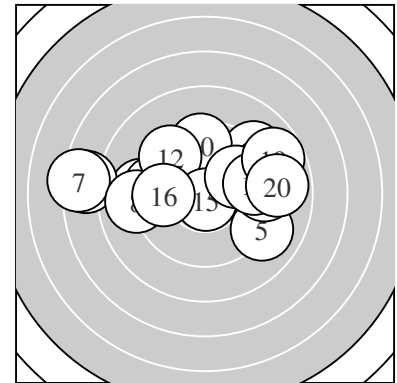

Serie 1:
 9.9 ↘ 9.1 ← 9.5 ← 9.1 ↗ 9.0 ↘
 7.5 ← 7.3 ← 9.0 ← 10.3 * 9.5 ↑
 beste Teiler 163.0 (9.) 264.4 (1.) 355.5 (10.)
 Trefferlage 2.48 mm links, 0.85 mm hoch
 Streuwert 3.45, horizontal: 4.58, vertikal: 1.70

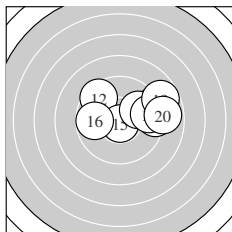

Serie 2:
 9.0 → 9.5 ↘ 9.1 ↗ 9.2 → 10.8 *
 9.8 ← 9.9 ↗ 9.5 → 8.7 ↗ 8.9 →
 beste Teiler 41.4 (15.) 254.6 (17.) 299.1 (16.)
 Trefferlage 2.37 mm rechts, 1.06 mm hoch
 Streuwert 2.32, horizontal: 3.10, vertikal: 1.04

Unterschrift des Schützen

Ergebnis: **197.3** (189)
 Serien: 99.0 98.3
 Zähler: 12 5 3 0 0 0 0 0 0 0
 Innenzehner: 9
 weiteste: 715 (16), 709 (13), 501 (10)
 beste Teiler 49.8 (11.) 63.1 (1.) 67.7 (3.)
 Trefferlage 0.21 mm links, 0.25 mm hoch
 Streuwert 2.41, horizontal: 3.13, vertikal: 1.36

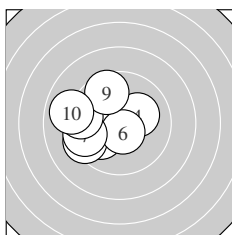
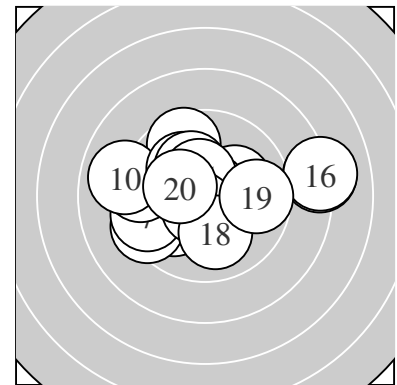

Serie 1:
 10.7 * 10.0 ↙ 10.7 * 10.2 * 9.4 ↙
 10.6 * 9.5 ← 9.4 ← 9.6 ↗ 8.9 ←
 beste Teiler 63.1 (1.) 67.7 (3.) 94.9 (6.)
 Trefferlage 1.78 mm links, 0.00 mm
 Streuwert 1.85, horizontal: 2.14, vertikal: 1.49

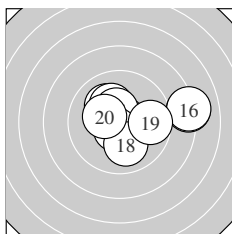

Serie 2:
 10.8 * 10.1 ↖ 8.1 → 10.2 * 10.4 *
 8.1 → 10.6 * 10.0 ↓ 9.7 → 10.3 *
 beste Teiler 49.8 (11.) 85.0 (17.) 127.8 (15.)
 Trefferlage 1.36 mm rechts, 0.50 mm hoch
 Streuwert 2.46, horizontal: 3.25, vertikal: 1.24

Unterschrift des Schützen

Ergebnis: **196.0** (188)
 Serien: 99.3 96.7
 Zähler: 9 10 1 0 0 0 0 0 0 0
 Innenzehner: 7
 weiteste: 725 (14), 487 (20), 457 (4)
 beste Teiler 38.0 (15.) 44.8 (6.) 123.7 (19.)
 Trefferlage 1.17 mm rechts, 0.71 mm hoch
 Streuwert 2.19, horizontal: 2.83, vertikal: 1.27

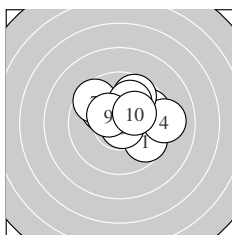
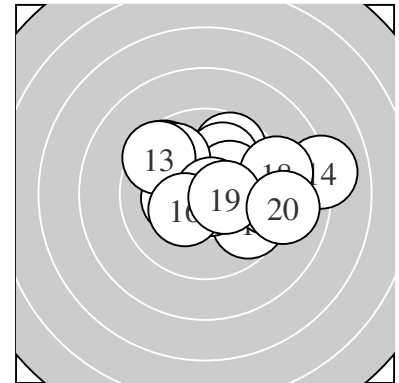

Serie 1:
 9.7 ↘ 9.7 → 10.1 ↘ 9.1 → 9.7 ↗
 10.8 * 9.6 ↘ 10.0 ↗ 10.4 * 10.2 *
 beste Teiler 44.8 (6.) 140.2 (9.) 183.0 (10.)
 Trefferlage 0.92 mm rechts, 0.98 mm hoch
 Streuwert 1.84, horizontal: 2.23, vertikal: 1.34

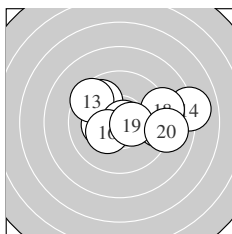

Serie 2:
 9.8 ↘ 10.3 * 9.5 ↘ 8.1 → 10.8 *
 10.3 * 9.3 → 9.1 → 10.5 * 9.0 →
 beste Teiler 38.0 (15.) 123.7 (19.) 157.4 (16.)
 Trefferlage 1.42 mm rechts, 0.44 mm hoch
 Streuwert 2.58, horizontal: 3.44, vertikal: 1.19

Unterschrift des Schützen

Ergebnis: **187.2** (180)
 Serien: 94.5 92.7
 Zähler: 9 6 2 2 1 0 0 0 0 0
 Innenzehner: 4
 weiteste: 1147 (17), 946 (3), 918 (8)
 beste Teiler 138.6 (11.) 153.0 (6.) 161.7 (9.)
 Trefferlage 1.01 mm links, 0.60 mm tief
 Streuwert 3.43, horizontal: 3.85, vertikal: 2.94

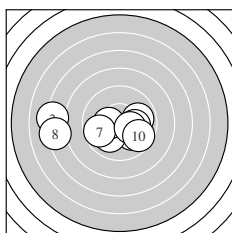
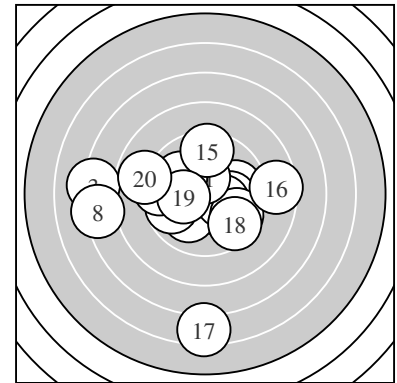

Serie 1:
 10.0 ↘ 10.0 ↙ 7.2 ← 9.9 → 10.1 →
 10.3 * 9.7 ← 7.3 ← 10.3 * 9.7 ↘
 beste Teiler 153.0 (6.) 161.7 (9.) 213.5 (5.)
 Trefferlage 1.36 mm links, 0.73 mm tief
 Streuwert 3.30, horizontal: 4.57, vertikal: 0.96

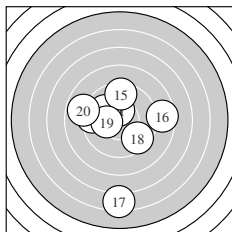

Serie 2:
 10.4 * 10.0 ↖ 9.4 ← 10.0 ↗ 9.5 ↑
 8.5 → 6.4 ↓ 9.5 ↘ 10.2 * 8.8 ←
 beste Teiler 138.6 (11.) 183.7 (19.) 240.3 (12.)
 Trefferlage 0.66 mm links, 0.47 mm tief
 Streuwert 3.71, horizontal: 3.19, vertikal: 4.16

Unterschrift des Schützen

Ergebnis: **192.1** (182)
 Serien: 97.0 95.1
 Zähler: 6 10 4 0 0 0 0 0 0 0
 Innenzehner: 5
 weiteste: 675 (20), 650 (14), 613 (2)
 beste Teiler 67.4 (13.) 109.5 (11.) 128.5 (4.)
 Trefferlage 0.67 mm rechts, 0.37 mm hoch
 Streuwert 2.70, horizontal: 3.54, vertikal: 1.43

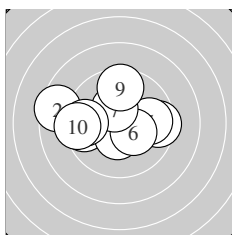
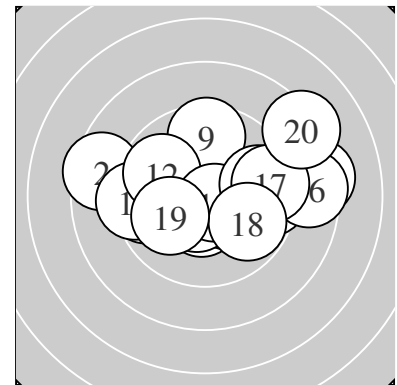

Serie 1:
 9.5 → 8.5 ← 9.6 ← 10.4 * 9.8 →
 10.3 * 10.4 * 9.6 ← 9.6 ↑ 9.3 ←
 beste Teiler 128.5 (4.) 148.0 (7.) 159.2 (6.)
 Trefferlage 0.94 mm links, 0.34 mm hoch
 Streuwert 2.44, horizontal: 3.16, vertikal: 1.38

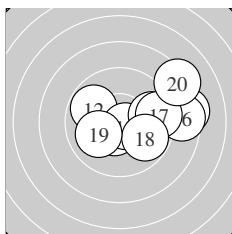

Serie 2:
 10.5 * 9.8 ↖ 10.7 * 8.4 → 9.7 →
 8.5 → 9.4 → 9.8 ↘ 10.0 ← 8.3 ↗
 beste Teiler 67.4 (13.) 109.5 (11.) 232.4 (19.)
 Trefferlage 2.28 mm rechts, 0.40 mm hoch
 Streuwert 2.56, horizontal: 3.27, vertikal: 1.56

Unterschrift des Schützen

Ergebnis: **202.8** (193)
 Serien: 102.1 100.7
 Zähler: 13 7 0 0 0 0 0 0 0 0
 Innenzehner: 10
 weiteste: 353 (1), 351 (11), 328 (19)
 beste Teiler 51.0 (7.) 73.1 (20.) 99.2 (5.)
 Trefferlage 0.75 mm rechts, 0.63 mm tief
 Streuwert 1.47, horizontal: 1.73, vertikal: 1.14

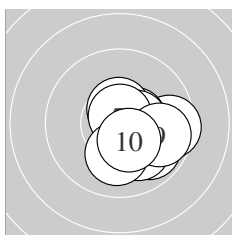
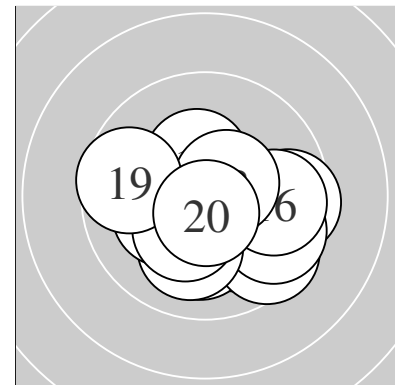

Serie 1:
 9.5 → 9.9 ↘ 10.5 * 10.1 ↘ 10.6 *
 10.5 * 10.7 * 10.1 ↓ 9.8 → 10.4 *
 beste Teiler 51.0 (7.) 99.2 (5.) 108.9 (3.)
 Trefferlage 1.23 mm rechts, 0.61 mm tief
 Streuwert 1.17, horizontal: 1.25, vertikal: 1.09

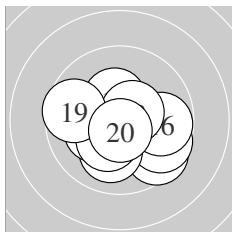

Serie 2:
 9.5 ↘ 9.6 ↘ 10.1 ↓ 10.2 * 10.3 *
 9.8 → 10.4 * 10.5 * 9.6 ← 10.7 *
 beste Teiler 73.1 (20.) 105.4 (18.) 148.1 (17.)
 Trefferlage 0.26 mm rechts, 0.64 mm tief
 Streuwert 1.71, horizontal: 2.07, vertikal: 1.25

Unterschrift des Schützen

Ergebnis: **200.4** (192)
 Serien: 102.4 98.0
 Zähler: 12 8 0 0 0 0 0 0 0 0
 Innenzehner: 8
 weiteste: 428 (14), 409 (20), 398 (18)
 beste Teiler 79.3 (2.) 88.5 (17.) 101.5 (1.)
 Trefferlage 0.03 mm rechts, 0.25 mm tief
 Streuwert 1.87, horizontal: 2.38, vertikal: 1.14

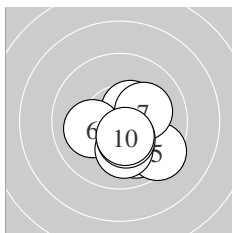
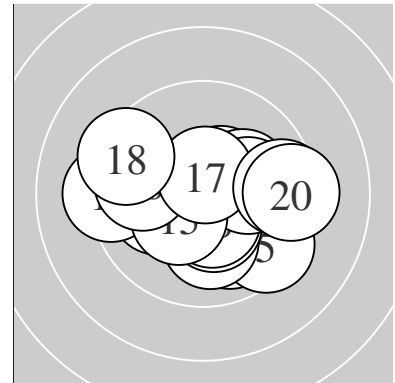

Serie 1:
 10.5 * 10.6 * 10.0 ↘ 10.5 * 9.5 ↘
 10.1 ← 10.2 * 10.1 ↓ 10.4 * 10.5 *
 beste Teiler 79.3 (2.) 101.5 (1.) 122.4 (4.)
 Trefferlage 0.76 mm rechts, 0.89 mm tief
 Streuwert 1.22, horizontal: 1.28, vertikal: 1.17

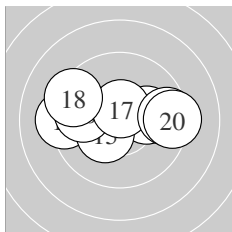

Serie 2:
 9.9 ← 9.9 ← 10.1 → 9.2 ← 10.3 *
 9.8 ← 10.6 * 9.4 ↖ 9.5 → 9.3 →
 beste Teiler 88.5 (17.) 153.5 (15.) 212.6 (13.)
 Trefferlage 0.69 mm links, 0.38 mm hoch
 Streuwert 2.20, horizontal: 3.03, vertikal: 0.70

Unterschrift des Schützen

Ergebnis: **203.2** (192)
 Serien: 103.1 100.1
 Zähler: 12 8 0 0 0 0 0 0 0 0
 Innenzehner: 10
 weiteste: 376 (16), 356 (2), 292 (11)
 beste Teiler 38.6 (4.) 40.6 (6.) 57.3 (20.)
 Trefferlage 0.01 mm links, 0.75 mm tief
 Streuwert 1.52, horizontal: 1.98, vertikal: 0.84

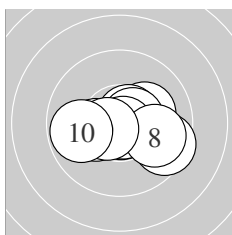
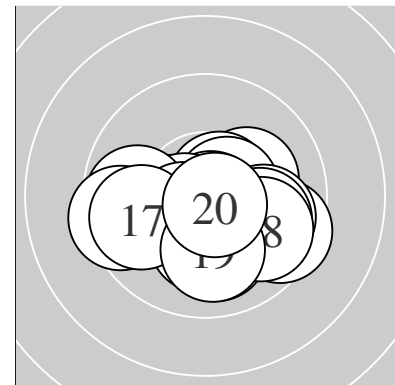

Serie 1:
 10.2 * 9.5 ↘ 10.6 * 10.8 * 10.6 *
 10.8 * 10.3 * 9.9 ↘ 10.6 * 9.8 ←
 beste Teiler 38.6 (4.) 40.6 (6.) 80.9 (3.)
 Trefferlage 0.41 mm rechts, 0.30 mm tief
 Streuwert 1.39, horizontal: 1.85, vertikal: 0.66

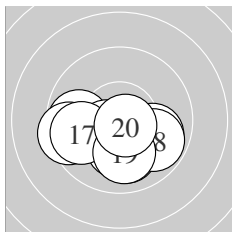

Serie 2:
 9.8 ← 10.2 * 10.5 * 9.9 ↘ 10.0 ↓
 9.4 ← 9.8 ← 9.8 ↘ 10.0 ↓ 10.7 *
 beste Teiler 57.3 (20.) 121.2 (13.) 191.6 (12.)
 Trefferlage 0.43 mm links, 1.20 mm tief
 Streuwert 1.59, horizontal: 2.11, vertikal: 0.76

Unterschrift des Schützen

Ergebnis: **201.1** (192)
 Serien: 100.3 100.8
 Zähler: 12 8 0 0 0 0 0 0 0 0
 Innenzehner: 12
 weiteste: 397 (10), 396 (13), 376 (5)
 beste Teiler 93.0 (6.) 103.4 (19.) 110.4 (4.)
 Trefferlage 0.50 mm links, 0.33 mm tief
 Streuwert 1.73, horizontal: 2.00, vertikal: 1.41

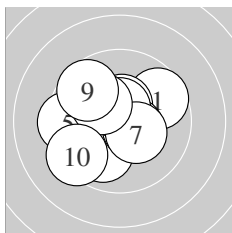
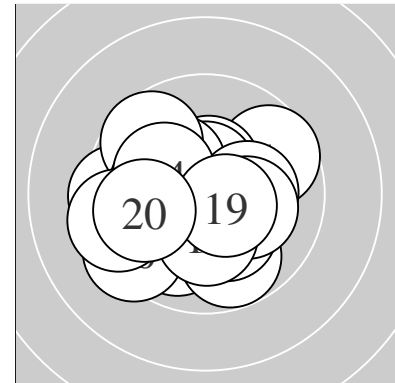

Serie 1:
 9.7 ↗ 10.5 * 9.9 ↘ 10.5 * 9.4 ←
 10.6 * 10.4 * 10.2 * 9.7 ↖ 9.4 ↙
 beste Teiler 93.0 (6.) 110.4 (4.) 119.0 (2.)
 Trefferlage 0.66 mm links, 0.11 mm hoch
 Streuwert 1.85, horizontal: 2.07, vertikal: 1.61

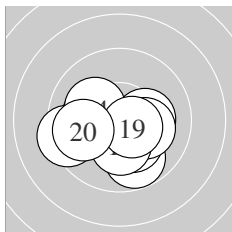

Serie 2:
 10.2 * 10.2 * 9.4 ← 10.2 * 9.8 ↓
 10.2 * 10.2 * 10.2 * 10.5 * 9.9 ←
 beste Teiler 103.4 (19.) 178.1 (18.) 183.3 (16.)
 Trefferlage 0.35 mm links, 0.77 mm tief
 Streuwert 1.62, horizontal: 2.03, vertikal: 1.08

Unterschrift des Schützen

Ergebnis: **182.0** (171)
 Serien: 91.8 90.2
 Zähler: 4 7 6 2 1 0 0 0 0 0
 Innenzehner: 3
 weiteste: 1030 (17), 910 (6), 811 (19)
 beste Teiler 13.6 (8.) 125.0 (18.) 199.8 (12.)
 Trefferlage 0.66 mm rechts, 0.46 mm tief
 Streuwert 3.81, horizontal: 5.15, vertikal: 1.59

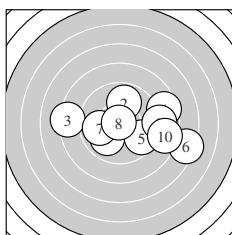
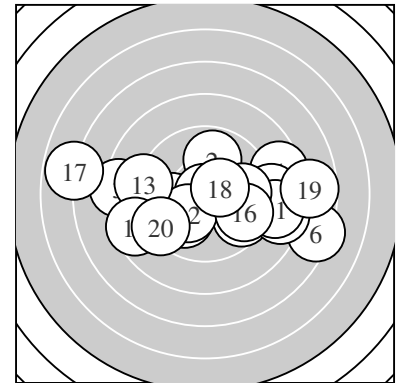

Serie 1:
 10.0 ↙ 9.9 ↑ 8.3 ← 8.5 → 9.6 ↘
 7.3 → 9.9 ← 10.9 * 8.9 → 8.5 →
 beste Teiler 13.6 (8.) 250.0 (1.) 264.3 (7.)
 Trefferlage 1.77 mm rechts, 0.38 mm tief
 Streuwert 3.55, horizontal: 4.70, vertikal: 1.77

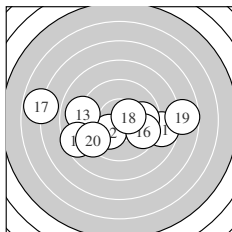

Serie 2:
 8.7 → 10.2 * 9.0 ← 9.8 → 8.6 ←
 9.6 → 6.8 ← 10.5 * 7.7 → 9.3 ←
 beste Teiler 125.0 (18.) 199.8 (12.) 290.2 (14.)
 Trefferlage 0.45 mm links, 0.54 mm tief
 Streuwert 4.09, horizontal: 5.59, vertikal: 1.48

Unterschrift des Schützen

Ergebnis: **189.1** (181)
 Serien: 96.5 92.6
 Zähler: 5 11 4 0 0 0 0 0 0 0
 Innenzehner: 3
 weiteste: 652 (13), 635 (11), 578 (15)
 beste Teiler 104.6 (9.) 166.9 (14.) 172.1 (1.)
 Trefferlage 1.24 mm rechts, 0.85 mm tief
 Streuwert 2.71, horizontal: 3.35, vertikal: 1.87

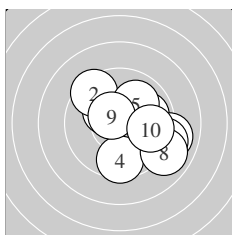
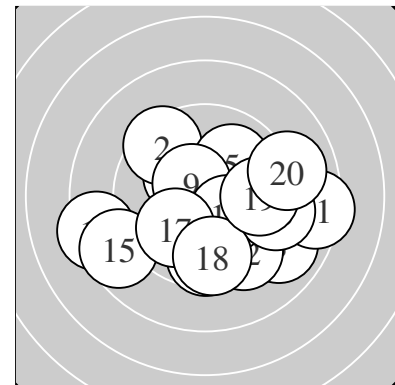

Serie 1:
 10.3 * 9.4 ↘ 9.9 → 9.6 ↓ 10.0 ↗
 9.0 → 9.1 → 8.9 ↘ 10.5 * 9.8 →
 beste Teiler 104.6 (9.) 172.1 (1.) 239.4 (5.)
 Trefferlage 1.57 mm rechts, 0.23 mm tief
 Streuwert 2.32, horizontal: 2.56, vertikal: 2.05

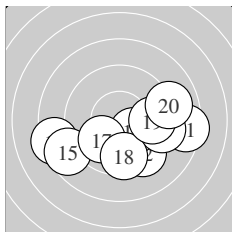

Serie 2:
 8.4 → 9.4 ↘ 8.3 ← 10.3 * 8.6 ↖
 9.3 → 10.0 ↖ 9.6 ↓ 9.7 → 9.0 →
 beste Teiler 166.9 (14.) 249.0 (17.) 312.0 (19.)
 Trefferlage 0.92 mm rechts, 1.46 mm tief
 Streuwert 3.10, horizontal: 4.11, vertikal: 1.53

Unterschrift des Schützen

Ergebnis: **188.0** (180)
 Serien: 93.3 94.7
 Zähler: 8 4 8 0 0 0 0 0 0 0
 Innenzehner: 4
 weiteste: 633 (1), 633 (17), 632 (3)
 beste Teiler 114.1 (20.) 126.6 (18.) 156.4 (5.)
 Trefferlage 0.77 mm rechts, 1.89 mm tief
 Streuwert 2.75, horizontal: 3.40, vertikal: 1.87

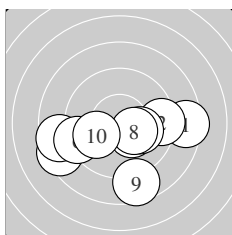
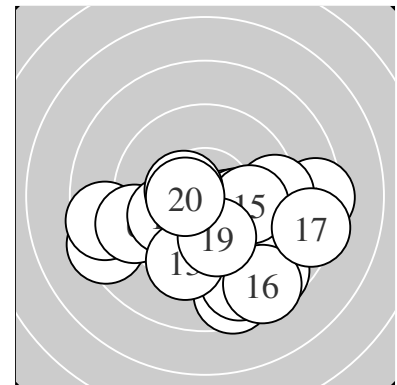

Serie 1:
 8.4 → 9.4 → 8.4 ← 8.6 ← 10.3 *
 9.2 ← 10.1 → 10.3 * 8.6 ↓ 10.0 ←
 beste Teiler 156.4 (5.) 156.5 (8.) 205.5 (7.)
 Trefferlage 0.12 mm links, 1.50 mm tief
 Streuwert 3.13, horizontal: 4.11, vertikal: 1.67

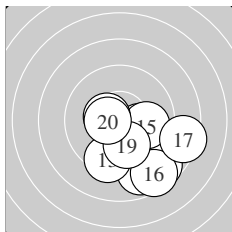

Serie 2:
 8.7 ↘ 8.8 ↓ 9.4 ↓ 10.1 → 9.9 →
 8.5 ↘ 8.4 → 10.4 * 10.0 ↓ 10.5 *
 beste Teiler 114.1 (20.) 126.6 (18.) 201.7 (14.)
 Trefferlage 1.66 mm rechts, 2.29 mm tief
 Streuwert 2.24, horizontal: 2.41, vertikal: 2.07

Unterschrift des Schützen

Ergebnis: **201.0** (194)
 Serien: 101.0 100.0
 Zähler: 15 4 1 0 0 0 0 0 0 0
 Innenzehner: 11
 weiteste: 551 (8), 422 (13), 419 (18)
 beste Teiler 60.0 (17.) 98.4 (2.) 130.6 (4.)
 Trefferlage 0.34 mm links, 0.12 mm hoch
 Streuwert 1.82, horizontal: 2.40, vertikal: 0.92

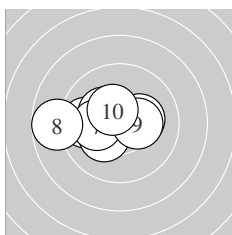
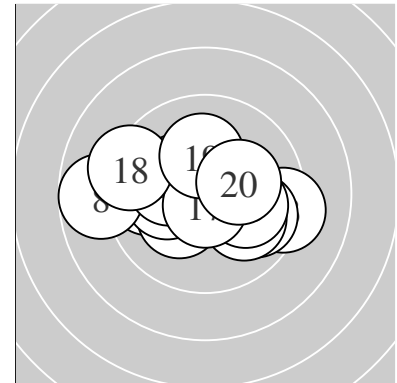

Serie 1:
 9.8 ← 10.6 * 10.2 * 10.4 * 10.3 *
 10.2 * 10.1 ← 8.7 ← 10.3 * 10.4 *
 beste Teiler 98.4 (2.) 130.6 (4.) 133.2 (10.)
 Trefferlage 1.22 mm links, 0.16 mm hoch
 Streuwert 1.57, horizontal: 2.09, vertikal: 0.73

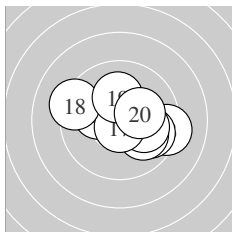

Serie 2:
 10.3 * 10.2 * 9.3 → 9.8 → 10.0 →
 10.1 → 10.7 * 9.3 ← 10.1 ↑ 10.2 *
 beste Teiler 60.0 (17.) 162.0 (11.) 188.4 (20.)
 Trefferlage 0.53 mm rechts, 0.07 mm hoch
 Streuwert 1.92, horizontal: 2.47, vertikal: 1.13

Unterschrift des Schützen

Ergebnis: **194.6** (186)
 Serien: 96.6 98.0
 Zähler: 9 9 1 1 0 0 0 0 0 0
 Innenzehner: 3
 weiteste: 769 (13), 556 (9), 443 (11)
 beste Teiler 85.5 (16.) 121.4 (18.) 127.9 (2.)
 Trefferlage 0.59 mm rechts, 0.07 mm hoch
 Streuwert 2.42, horizontal: 2.70, vertikal: 2.11

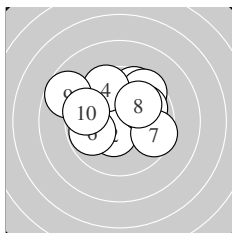
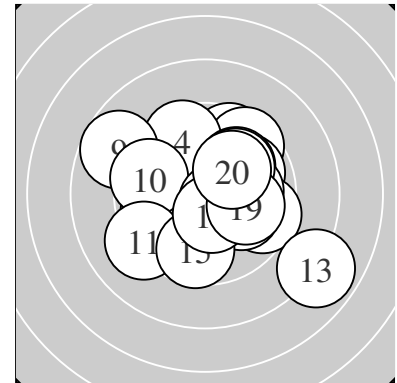

Serie 1:
 9.6 ↗ 10.4 * 9.5 ↗ 9.6 ↖ 9.9 ↗
 9.8 ↖ 9.5 ↘ 10.0 ↗ 8.7 ↘ 9.6 ↖
 beste Teiler 127.9 (2.) 240.8 (8.) 265.6 (5.)
 Trefferlage 0.15 mm links, 1.18 mm hoch
 Streuwert 2.33, horizontal: 2.80, vertikal: 1.75

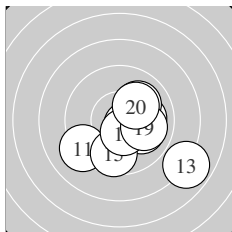

Serie 2:
 9.2 ↖ 10.0 → 7.9 ↘ 10.0 ↘ 9.7 ↓
 10.6 * 10.0 ↗ 10.5 * 10.0 → 10.1 ↗
 beste Teiler 85.5 (16.) 121.4 (18.) 208.1 (20.)
 Trefferlage 1.34 mm rechts, 1.03 mm tief
 Streuwert 2.22, horizontal: 2.51, vertikal: 1.89

Unterschrift des Schützen

Ergebnis: **186.2** (177)
 Serien: 96.7 89.5
 Zähler: 6 8 4 1 1 0 0 0 0 0
 Innenzehner: 4
 weiteste: 1004 (11), 991 (20), 605 (12)
 beste Teiler 87.0 (17.) 179.6 (10.) 190.5 (15.)
 Trefferlage 2.08 mm rechts, 1.31 mm hoch
 Streuwert 2.98, horizontal: 3.74, vertikal: 1.94

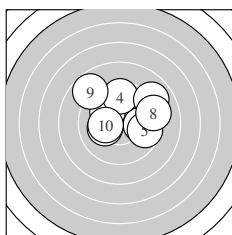
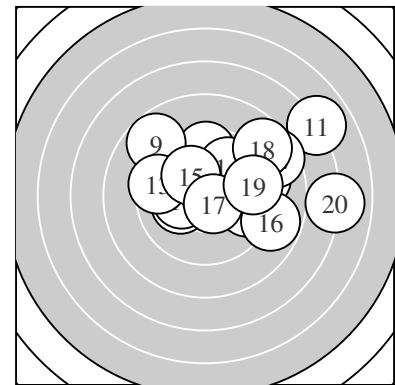

Serie 1:
 10.1 ↗ 10.1 ↘ 9.9 → 9.6 ↑ 9.6 →
 9.0 ↗ 10.2 * 9.2 → 8.8 ↘ 10.2 *
 beste Teiler 179.6 (10.) 197.3 (7.) 209.4 (2.)
 Trefferlage 0.73 mm rechts, 1.20 mm hoch
 Streuwert 2.38, horizontal: 2.86, vertikal: 1.76

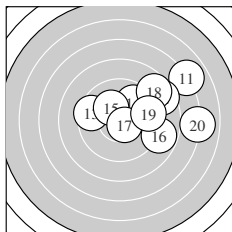

Serie 2:
 6.9 ↗ 8.5 ↗ 9.5 ← 9.8 ↗ 10.2 *
 8.8 ↗ 10.6 * 8.7 ↗ 9.5 → 7.0 →
 beste Teiler 87.0 (17.) 190.5 (15.) 281.4 (14.)
 Trefferlage 3.44 mm rechts, 1.43 mm hoch
 Streuwert 3.32, horizontal: 4.15, vertikal: 2.19

Unterschrift des Schützen

Ergebnis: **192.9** (185)
 Serien: 99.5 93.4
 Zähler: 8 10 1 1 0 0 0 0 0 0
 Innenzehner: 5
 weiteste: 967 (18), 574 (20), 493 (17)
 beste Teiler 91.7 (16.) 107.9 (10.) 126.9 (4.)
 Trefferlage 0.69 mm links, 0.77 mm tief
 Streuwert 2.67, horizontal: 3.58, vertikal: 1.20

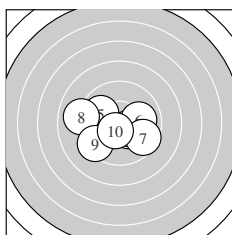
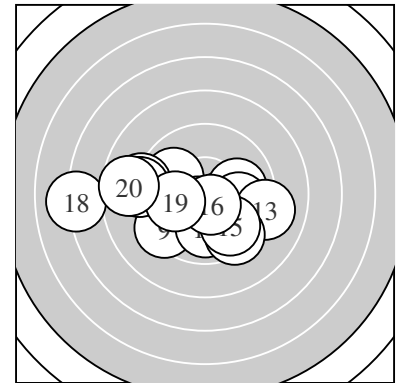

Serie 1:
 10.4 * 10.1 → 10.2 * 10.4 * 9.9 ↖
 10.0 → 9.6 ↘ 9.0 ← 9.4 ↙ 10.5 *
 beste Teiler 107.9 (10.) 126.9 (4.) 145.4 (1.)
 Trefferlage 0.28 mm links, 0.49 mm tief
 Streuwert 2.02, horizontal: 2.62, vertikal: 1.14

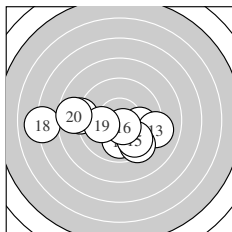

Serie 2:
 9.9 ↓ 9.9 → 9.1 → 9.4 ↘ 9.7 ↘
 10.6 * 9.0 ← 7.1 ← 10.0 ← 8.7 ←
 beste Teiler 91.7 (16.) 230.8 (19.) 251.0 (11.)
 Trefferlage 1.09 mm links, 1.05 mm tief
 Streuwert 3.27, horizontal: 4.45, vertikal: 1.24

Unterschrift des Schützen

Ergebnis: **200.5** (190)
 Serien: 99.5 101.0
 Zähler: 12 6 2 0 0 0 0 0 0 0
 Innenzehner: 10
 weiteste: 572 (4), 533 (10), 351 (3)
 beste Teiler 68.1 (7.) 99.0 (9.) 107.4 (1.)
 Trefferlage 1.26 mm links, 0.06 mm hoch
 Streuwert 1.73, horizontal: 2.30, vertikal: 0.84

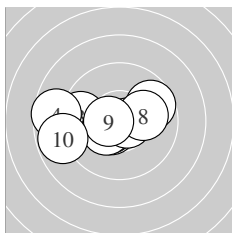
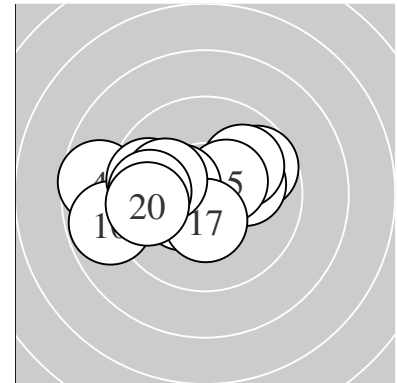

Serie 1:
 10.5 * 10.5 * 9.5 ← 8.7 ← 10.4 *
 9.7 ↗ 10.7 * 10.1 → 10.6 * 8.8 ←
 beste Teiler 68.1 (7.) 99.0 (9.) 107.4 (1.)
 Trefferlage 1.25 mm links, 0.09 mm tief
 Streuwert 2.09, horizontal: 2.82, vertikal: 0.88

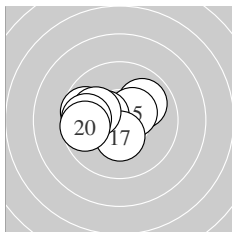

Serie 2:
 9.7 ← 9.9 ↗ 10.3 * 10.3 * 10.4 *
 10.4 * 10.4 * 10.1 ← 9.8 ← 9.7 ←
 beste Teiler 132.7 (15.) 143.0 (17.) 145.7 (16.)
 Trefferlage 1.27 mm links, 0.23 mm hoch
 Streuwert 1.39, horizontal: 1.79, vertikal: 0.81

Unterschrift des Schützen

Ergebnis: **188.5** (180)
 Serien: 93.7 94.8
 Zähler: 9 4 5 2 0 0 0 0 0 0
 Innenzehner: 7
 weiteste: 875 (19), 845 (17), 712 (6)
 beste Teiler 22.2 (12.) 88.6 (13.) 146.0 (2.)
 Trefferlage 0.41 mm links, 0.63 mm hoch
 Streuwert 3.29, horizontal: 4.28, vertikal: 1.82

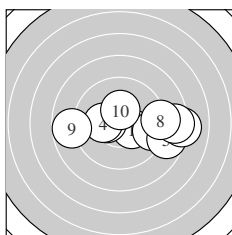
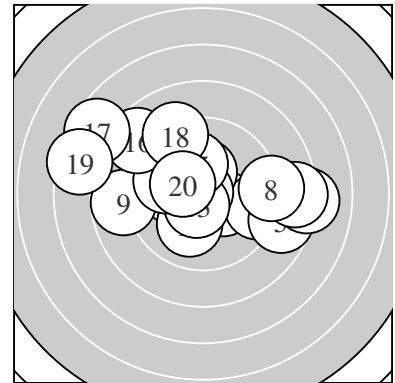

Serie 1:
 10.3 * 10.4 * 9.4 → 10.2 * 8.7 →
 8.1 → 8.4 → 9.1 → 8.8 ← 10.3 *
 beste Teiler 146.0 (2.) 151.2 (10.) 153.8 (1.)
 Trefferlage 1.98 mm rechts, 0.24 mm tief
 Streuwert 2.98, horizontal: 4.12, vertikal: 0.87

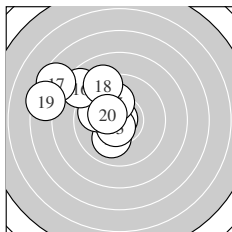

Serie 2:
 10.1 ↓ 10.9 * 10.6 * 9.9 ↖ 10.1 ↑
 8.6 ↘ 7.6 ↘ 9.2 ↘ 7.5 ↖ 10.3 *
 beste Teiler 22.2 (12.) 88.6 (13.) 155.6 (20.)
 Trefferlage 2.81 mm links, 1.51 mm hoch
 Streuwert 2.58, horizontal: 2.96, vertikal: 2.12

Unterschrift des Schützen

Ergebnis: **156.9** (147)
 Serien: 73.7 83.2
 Zähler: 1 5 4 4 3 2 1 0 0 0
 Innenzehner: 1
 weiteste: 1551 (5), 1325 (10), 1318 (12)
 beste Teiler 175.4 (6.) 304.8 (17.) 353.9 (19.)
 Trefferlage 4.72 mm links, 3.62 mm hoch
 Streuwert 4.54, horizontal: 6.21, vertikal: 1.66

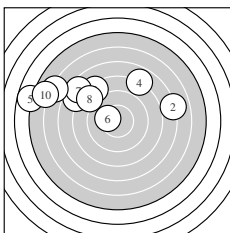
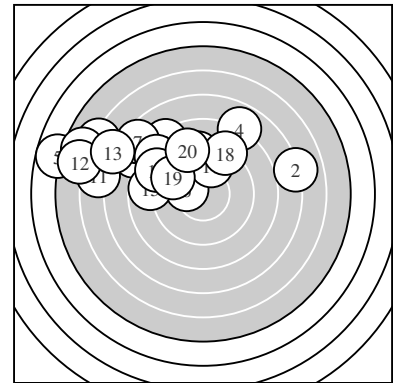

Serie 1:
 7.7 ↘ 7.0 → 8.3 ↖ 7.9 ↗ 4.7 ←
 10.3 * 7.5 ↘ 8.5 ↘ 6.1 ↖ 5.7 ←
 beste Teiler 175.4 (6.) 617.5 (8.) 671.6 (3.)
 Trefferlage 4.91 mm links, 4.24 mm hoch
 Streuwert 5.41, horizontal: 7.44, vertikal: 1.78

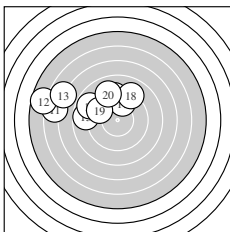

Serie 2:
 6.6 ← 5.7 ← 6.8 ↖ 9.3 ↑ 8.8 ←
 8.8 ↘ 9.7 ↑ 9.0 ↑ 9.5 ↖ 9.0 ↖
 beste Teiler 304.8 (17.) 353.9 (19.) 424.0 (14.)
 Trefferlage 4.52 mm links, 3.01 mm hoch
 Streuwert 3.72, horizontal: 5.09, vertikal: 1.34

Unterschrift des Schützen

Ergebnis: **180.1** (171)
 Serien: 94.3 85.8
 Zähler: 4 7 6 2 1 0 0 0 0 0
 Innenzehner: 1
 weiteste: 1172 (16), 985 (12), 807 (11)
 beste Teiler 97.2 (6.) 217.8 (3.) 233.0 (1.)
 Trefferlage 0.11 mm rechts, 0.34 mm hoch
 Streuwert 3.99, horizontal: 5.42, vertikal: 1.54

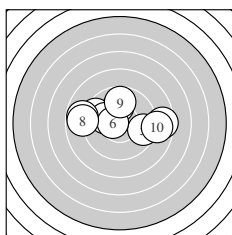
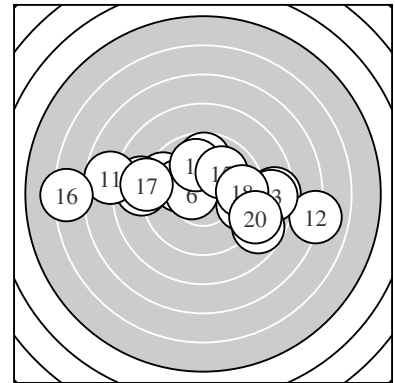

Serie 1:
 10.0 ↑ 9.5 ← 10.1 ← 8.8 ← 9.5 →
 10.6 * 8.5 → 8.8 ← 9.7 ↑ 8.8 →
 beste Teiler 97.2 (6.) 217.8 (3.) 233.0 (1.)
 Trefferlage 0.23 mm links, 0.73 mm hoch
 Streuwert 3.02, horizontal: 4.09, vertikal: 1.23

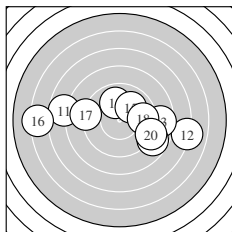

Serie 2:
 7.7 ← 7.0 → 8.6 → 9.9 ↑ 10.0 ↗
 6.3 ← 9.0 ← 9.6 → 8.7 ↘ 9.0 ↘
 beste Teiler 243.8 (15.) 254.4 (14.) 335.7 (18.)
 Trefferlage 0.45 mm rechts, 0.04 mm tief
 Streuwert 4.91, horizontal: 6.72, vertikal: 1.77

Unterschrift des Schützen

Ergebnis: **178.1** (169)
 Serien: 91.2 86.9
 Zähler: 4 5 9 1 0 1 0 0 0 0
 Innenzehner: 3
 weiteste: 1312 (18), 973 (1), 670 (5)
 beste Teiler 68.8 (9.) 129.1 (12.) 190.1 (7.)
 Trefferlage 3.04 mm links, 0.76 mm tief
 Streuwert 3.59, horizontal: 4.90, vertikal: 1.34

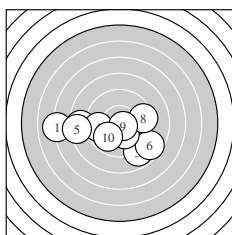
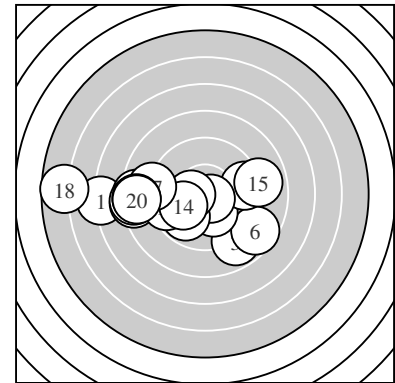

Serie 1:
 7.1 ← 8.5 ← 8.9 ↘ 9.6 ← 8.3 ←
 8.6 ↘ 10.2 * 9.5 → 10.7 * 9.8 ↙
 beste Teiler 68.8 (9.) 190.1 (7.) 276.5 (10.)
 Trefferlage 1.50 mm links, 1.37 mm tief
 Streuwert 3.60, horizontal: 4.85, vertikal: 1.57

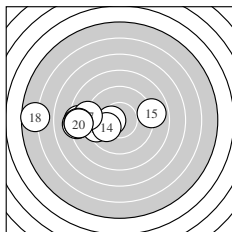

Serie 2:
 8.4 ← 10.4 * 9.4 ← 10.0 ← 8.9 →
 8.3 ← 9.0 ← 5.7 ← 8.4 ← 8.4 ←
 beste Teiler 129.1 (12.) 229.9 (14.) 377.3 (13.)
 Trefferlage 4.58 mm links, 0.15 mm tief
 Streuwert 3.34, horizontal: 4.67, vertikal: 0.73

Unterschrift des Schützen

Ergebnis: **178.6** (170)
 Serien: 87.7 90.9
 Zähler: 4 8 4 3 0 1 0 0 0 0
 Innenzehner: 2
 weiteste: 1435 (20), 851 (3), 752 (1)
 beste Teiler 159.8 (16.) 181.1 (15.) 237.8 (13.)
 Trefferlage 0.10 mm rechts, 0.62 mm tief
 Streuwert 4.20, horizontal: 5.04, vertikal: 3.14

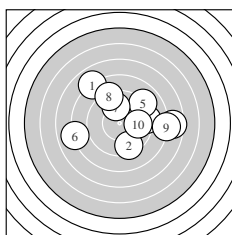
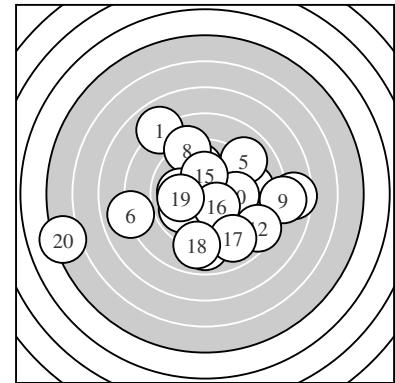

Serie 1:
 7.9 ↖ 9.4 ↘ 7.5 → 9.2 → 9.0 ↗
 8.0 ← 9.9 ↑ 9.1 ↖ 7.9 → 9.8 →
 beste Teiler 270.5 (7.) 295.2 (10.) 385.1 (2.)
 Trefferlage 1.47 mm rechts, 1.04 mm hoch
 Streuwert 4.11, horizontal: 4.99, vertikal: 2.97

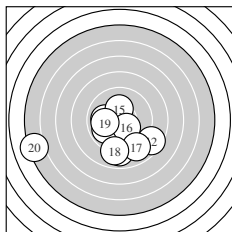

Serie 2:
 8.9 ↓ 8.5 ↘ 10.0 ← 9.9 ↖ 10.2 *
 10.3 * 8.9 ↘ 9.0 ↓ 10.0 ← 5.2 ←
 beste Teiler 159.8 (16.) 181.1 (15.) 237.8 (13.)
 Trefferlage 1.26 mm links, 2.29 mm tief
 Streuwert 3.90, horizontal: 4.96, vertikal: 2.42

Unterschrift des Schützen

Ergebnis: **182.4** (172)
 Serien: 90.6 91.8
 Zähler: 4 10 3 1 1 1 0 0 0 0
 Innenzehner: 3
 weiteste: 1490 (6), 1158 (16), 824 (19)
 beste Teiler 100.7 (17.) 128.3 (11.) 181.3 (9.)
 Trefferlage 0.31 mm rechts, 1.05 mm tief
 Streuwert 4.06, horizontal: 5.60, vertikal: 1.26

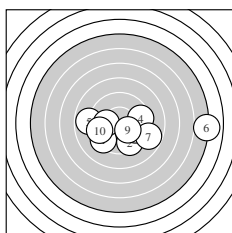
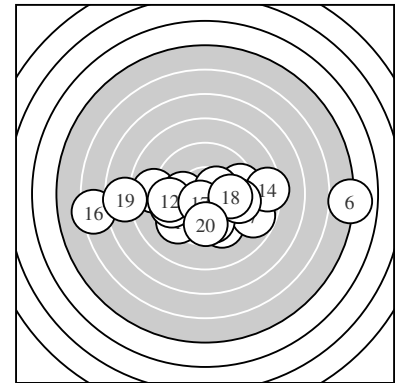

Serie 1:
 9.4 ↙ 9.5 ↓ 9.8 ↘ 9.5 → 8.9 ←
 5.0 → 8.8 ↘ 10.0 ← 10.2 * 9.5 ←
 beste Teiler 181.3 (9.) 227.0 (8.) 291.6 (3.)
 Trefferlage 1.55 mm rechts, 1.14 mm tief
 Streuwert 4.19, horizontal: 5.77, vertikal: 1.34

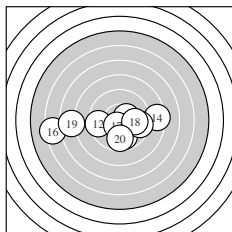

Serie 2:
 10.4 * 9.5 ← 9.8 ↓ 8.4 → 9.5 →
 6.3 ← 10.6 * 9.9 → 7.7 ← 9.7 ↓
 beste Teiler 100.7 (17.) 128.3 (11.) 261.2 (18.)
 Trefferlage 0.93 mm links, 0.97 mm tief
 Streuwert 3.94, horizontal: 5.43, vertikal: 1.24

Unterschrift des Schützen

Ergebnis: **189.5** (180)
 Serien: 98.5 91.0
 Zähler: 9 5 3 3 0 0 0 0 0 0
 Innenzehner: 7
 weiteste: 881 (19), 805 (7), 765 (12)
 beste Teiler 88.0 (8.) 107.0 (5.) 115.6 (4.)
 Trefferlage 1.06 mm rechts, 1.74 mm tief
 Streuwert 2.84, horizontal: 3.71, vertikal: 1.57

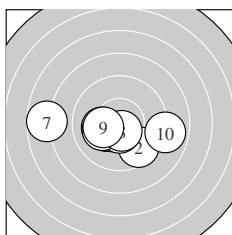
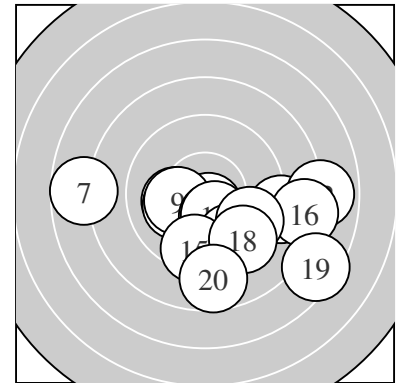

Serie 1:
 10.1 ← 9.6 ↘ 10.3 * 10.5 * 10.5 *
 10.1 ← 7.7 ← 10.6 * 10.2 * 8.9 →
 beste Teiler 88.0 (8.) 107.0 (5.) 115.6 (4.)
 Trefferlage 0.85 mm links, 0.88 mm tief
 Streuwert 2.42, horizontal: 3.35, vertikal: 0.72

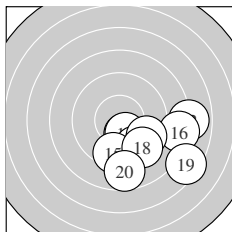

Serie 2:
 10.3 * 7.9 → 10.3 * 9.6 ↘ 9.5 ↓
 8.3 → 9.6 ↘ 9.4 ↘ 7.4 ↘ 8.7 ↓
 beste Teiler 153.9 (13.) 159.3 (11.) 336.6 (14.)
 Trefferlage 2.97 mm rechts, 2.59 mm tief
 Streuwert 2.52, horizontal: 3.11, vertikal: 1.74

Unterschrift des Schützen

Ergebnis: **0.0** (0)_{DNS}

Serien:

Zähler: 0 0 0 0 0 0 0 0 0 0

Innenzehner: 0

weiteste:

beste Teiler – Schütze ist nicht zum Wettkampf angetreten

Trefferlage 0.00 mm , 0.00 mm

Streuwert

Unterschrift des Schützen

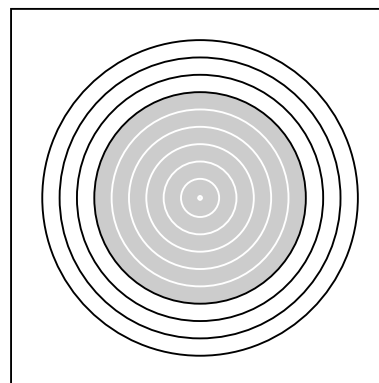

Ergebnis: **194.9** (186)
 Serien: 95.9 99.0
 Zähler: 10 6 4 0 0 0 0 0 0 0
 Innenzehner: 8
 weiteste: 618 (10), 601 (8), 593 (13)
 beste Teiler 80.0 (1.) 115.3 (19.) 124.0 (12.)
 Trefferlage 0.56 mm rechts, 0.14 mm hoch
 Streuwert 2.49, horizontal: 3.30, vertikal: 1.23

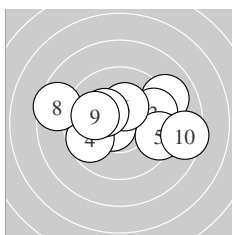
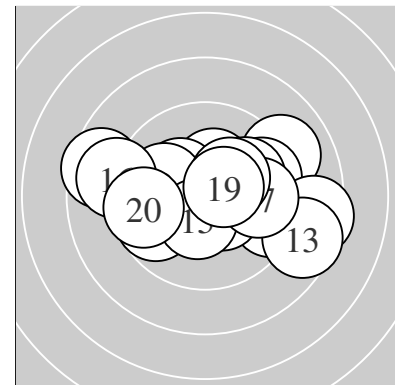

Serie 1:
 10.6 * 9.0 ↗ 9.6 → 9.7 ← 9.4 →
 10.3 * 10.3 * 8.5 ← 10.0 ← 8.5 →
 beste Teiler 80.0 (1.) 160.0 (6.) 170.6 (7.)
 Trefferlage 0.47 mm rechts, 0.40 mm hoch
 Streuwert 2.80, horizontal: 3.74, vertikal: 1.32

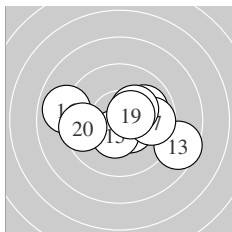

Serie 2:
 10.0 → 10.5 * 8.6 ↘ 10.4 * 10.4 *
 8.9 ← 9.8 → 10.3 * 10.5 * 9.6 ←
 beste Teiler 115.3 (19.) 124.0 (12.) 135.6 (15.)
 Trefferlage 0.65 mm rechts, 0.11 mm tief
 Streuwert 2.28, horizontal: 3.01, vertikal: 1.14

Unterschrift des Schützen

Ergebnis: **188.5** (183)
 Serien: 90.6 97.9
 Zähler: 7 12 0 0 0 1 0 0 0 0
 Innenzehner: 4
 weiteste: 1487 (7), 477 (10), 459 (8)
 beste Teiler 93.7 (13.) 136.1 (11.) 166.9 (20.)
 Trefferlage 0.20 mm links, 1.12 mm hoch
 Streuwert 3.33, horizontal: 4.52, vertikal: 1.34

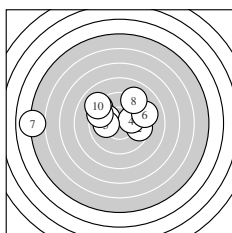
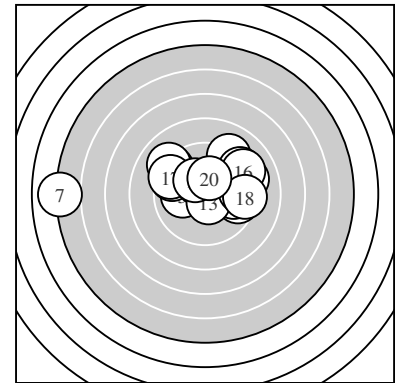

Serie 1:
 9.2 ↘ 9.6 → 10.0 ↖ 10.1 → 10.0 ←
 9.1 → 5.0 ← 9.1 ↗ 9.5 ↖ 9.0 ↖
 beste Teiler 209.8 (4.) 229.7 (5.) 230.4 (3.)
 Trefferlage 1.76 mm links, 1.29 mm hoch
 Streuwert 4.06, horizontal: 5.54, vertikal: 1.51

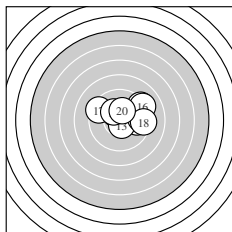

Serie 2:
 10.4 * 9.8 → 10.6 * 9.2 ↗ 9.5 →
 9.1 ↗ 9.4 ↖ 9.3 → 10.3 * 10.3 *
 beste Teiler 93.7 (13.) 136.1 (11.) 166.9 (20.)
 Trefferlage 1.36 mm rechts, 0.95 mm hoch
 Streuwert 2.05, horizontal: 2.64, vertikal: 1.19

Unterschrift des Schützen