

Ergebnis: **192.5** (183)
 Serien: 97.8 94.7
 Zähler: 9 6 4 1 0 0 0 0 0 0
 Innenzehner: 9
 weiteste: 753 (20), 744 (16), 743 (1)
 beste Teiler 52.0 (11.) 63.5 (9.) 72.0 (14.)
 Trefferlage 0.40 mm links, 1.89 mm hoch
 Streuwert 2.58, horizontal: 3.35, vertikal: 1.45

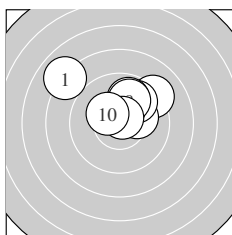

Serie 1:
 8.0 ↘ 9.5 ↗ 9.2 ↗ 10.2 * 9.8 ↗
 9.9 ↗ 10.3 * 9.9 ↗ 10.7 * 10.3 *
 beste Teiler 63.5 (9.) 156.2 (7.) 161.0 (10.)
 Trefferlage 0.53 mm rechts, 2.07 mm hoch
 Streuwert 2.01, horizontal: 2.56, vertikal: 1.24

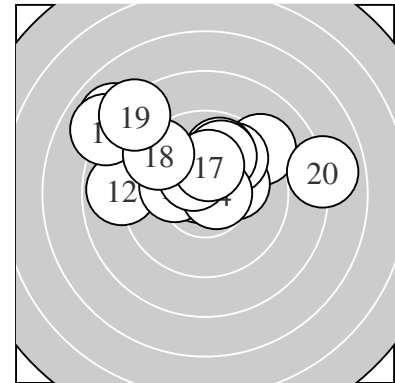
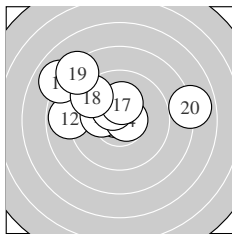

Serie 2:
 10.7 * 8.9 ← 10.2 * 10.7 * 10.4 *
 8.0 ↘ 10.2 * 9.4 ↘ 8.3 ↘ 7.9 →
 beste Teiler 52.0 (11.) 72.0 (14.) 138.7 (15.)
 Trefferlage 1.34 mm links, 1.70 mm hoch
 Streuwert 3.00, horizontal: 3.89, vertikal: 1.67

Unterschrift des Schützen

Ergebnis: **197.4** (189)
 Serien: 99.7 97.7
 Zähler: 11 7 2 0 0 0 0 0 0 0
 Innenzehner: 5
 weiteste: 553 (16), 528 (14), 429 (9)
 beste Teiler 58.5 (18.) 62.0 (2.) 115.8 (12.)
 Trefferlage 0.22 mm links, 0.12 mm tief
 Streuwert 2.16, horizontal: 2.39, vertikal: 1.91

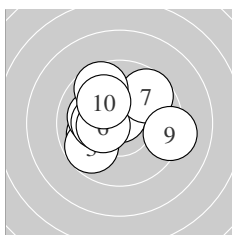
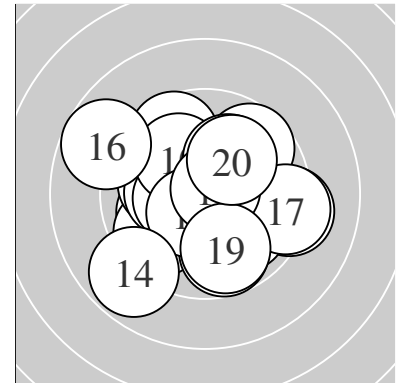

Serie 1:
 10.0 ↙ 10.7 * 9.7 ↙ 10.1 ↖ 10.2 *
 10.4 * 9.7 ↗ 9.6 ↘ 9.2 → 10.1 ↘
 beste Teiler 62.0 (2.) 138.6 (6.) 180.1 (5.)
 Trefferlage 0.62 mm links, 0.42 mm hoch
 Streuwert 1.88, horizontal: 2.18, vertikal: 1.52

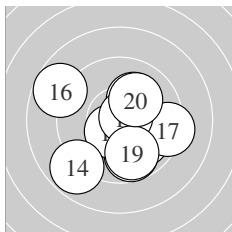

Serie 2:
 9.7 ↓ 10.5 * 10.1 ↗ 8.8 ↙ 10.0 ↘
 8.7 ↖ 9.3 → 10.7 * 9.8 ↓ 10.1 ↗
 beste Teiler 58.5 (18.) 115.8 (12.) 208.0 (13.)
 Trefferlage 0.16 mm rechts, 0.66 mm tief
 Streuwert 2.42, horizontal: 2.63, vertikal: 2.18

Unterschrift des Schützen

Ergebnis: **199.0** (191)
 Serien: 100.9 98.1
 Zähler: 13 5 2 0 0 0 0 0 0 0
 Innenzehner: 11
 weiteste: 663 (16), 652 (1), 398 (19)
 beste Teiler 47.2 (10.) 93.0 (6.) 105.2 (3.)
 Trefferlage 1.01 mm links, 0.46 mm tief
 Streuwert 2.00, horizontal: 2.58, vertikal: 1.17

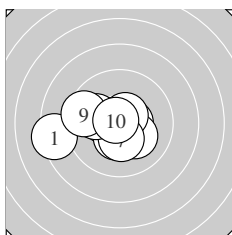
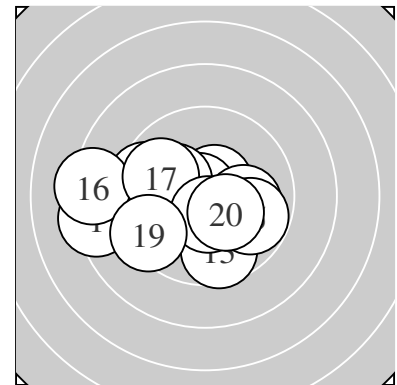

Serie 1:
 8.3 ← 10.3 * 10.5 * 10.4 * 10.2 *
 10.6 * 10.3 * 10.0 ← 9.5 ← 10.8 *
 beste Teiler 47.2 (10.) 93.0 (6.) 105.2 (3.)
 Trefferlage 1.12 mm links, 0.24 mm tief
 Streuwert 1.84, horizontal: 2.41, vertikal: 0.99

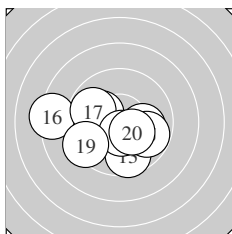

Serie 2:
 10.2 * 10.0 → 9.6 ↓ 10.2 * 9.8 →
 8.3 ← 9.8 ← 10.5 * 9.4 ← 10.3 *
 beste Teiler 110.4 (18.) 155.0 (20.) 181.0 (11.)
 Trefferlage 0.90 mm links, 0.68 mm tief
 Streuwert 2.24, horizontal: 2.87, vertikal: 1.35

Unterschrift des Schützen

Ergebnis: **189.9** (183)
 Serien: 94.3 95.6
 Zähler: 10 3 7 0 0 0 0 0 0 0
 Innenzehner: 5
 weiteste: 725 (20), 637 (11), 634 (8)
 beste Teiler 153.3 (12.) 162.7 (5.) 166.9 (2.)
 Trefferlage 1.42 mm links, 0.84 mm tief
 Streuwert 2.73, horizontal: 3.60, vertikal: 1.41

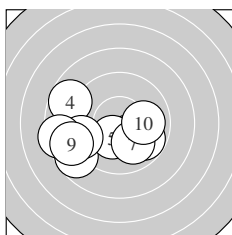
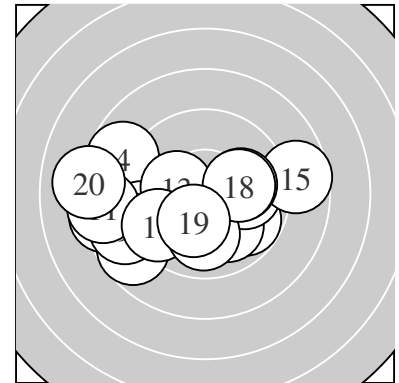

Serie 1:
 8.7 ↙ 10.3 * 9.8 ↘ 8.7 ↖ 10.3 *
 9.3 ← 10.0 ↘ 8.4 ← 8.8 ← 10.0 →
 beste Teiler 162.7 (5.) 166.9 (2.) 241.9 (7.)
 Trefferlage 1.81 mm links, 1.24 mm tief
 Streuwert 2.66, horizontal: 3.45, vertikal: 1.49

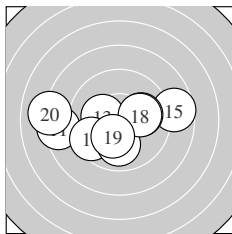

Serie 2:
 8.4 ← 10.3 * 10.2 * 9.6 ↙ 8.7 →
 10.0 → 10.0 ↓ 10.1 → 10.2 * 8.1 ←
 beste Teiler 153.3 (12.) 179.7 (13.) 181.4 (19.)
 Trefferlage 1.03 mm links, 0.44 mm tief
 Streuwert 2.89, horizontal: 3.89, vertikal: 1.27

Unterschrift des Schützen

Ergebnis: **187.1** (178)
 Serien: 95.2 91.9
 Zähler: 7 7 5 0 0 1 0 0 0 0
 Innenzehner: 7
 weiteste: 1335 (16), 662 (13), 653 (9)
 beste Teiler 56.6 (14.) 94.8 (7.) 105.1 (3.)
 Trefferlage 1.50 mm links, 1.12 mm hoch
 Streuwert 3.29, horizontal: 4.45, vertikal: 1.38

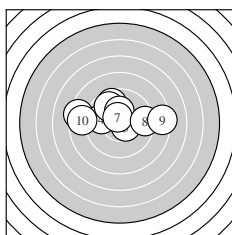
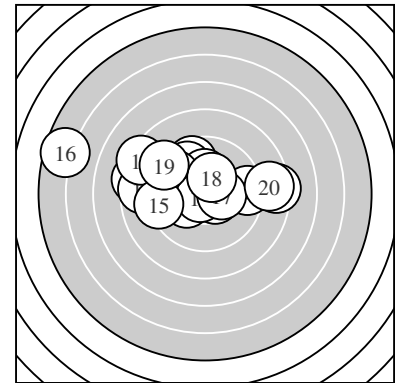

Serie 1:
 9.6 ↖ 8.4 ← 10.5 * 9.8 ← 9.7 ↖
 10.2 * 10.6 * 9.4 → 8.3 → 8.7 ←
 beste Teiler 94.8 (7.) 105.1 (3.) 187.0 (6.)
 Trefferlage 0.66 mm links, 1.11 mm hoch
 Streuwert 2.88, horizontal: 3.92, vertikal: 1.09

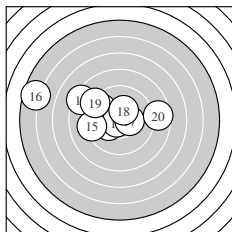

Serie 2:
 10.2 * 9.6 ↖ 8.3 ↖ 10.7 * 9.2 ←
 5.6 ↖ 10.3 * 10.3 * 9.1 ↖ 8.6 →
 beste Teiler 56.6 (14.) 152.2 (17.) 162.8 (18.)
 Trefferlage 2.35 mm links, 1.12 mm hoch
 Streuwert 3.72, horizontal: 4.98, vertikal: 1.69

Unterschrift des Schützen

Ergebnis: **193.7** (184)
 Serien: 98.6 95.1
 Zähler: 8 9 2 1 0 0 0 0 0 0
 Innenzehner: 7
 weiteste: 969 (14), 562 (6), 517 (19)
 beste Teiler 54.3 (5.) 57.0 (8.) 100.3 (9.)
 Trefferlage 0.47 mm links, 0.05 mm hoch
 Streuwert 2.74, horizontal: 3.54, vertikal: 1.57

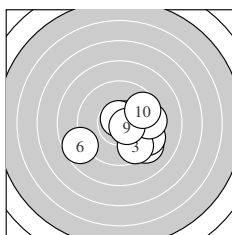
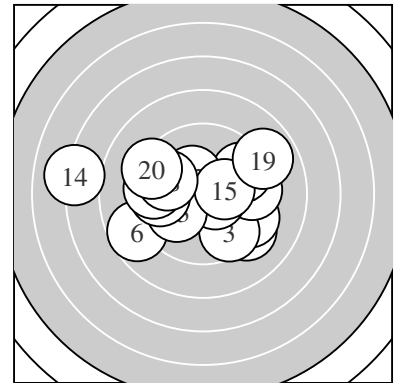

Serie 1:
 9.3 ↘ 9.4 ↘ 9.6 ↘ 9.5 → 10.7 *
 8.7 ↙ 10.5 * 10.7 * 10.6 * 9.6 ↗
 beste Teiler 54.3 (5.) 57.0 (8.) 100.3 (9.)
 Trefferlage 1.22 mm rechts, 0.69 mm tief
 Streuwert 2.16, horizontal: 2.56, vertikal: 1.66

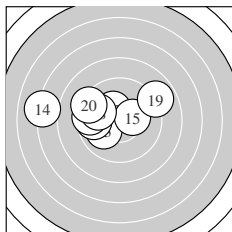

Serie 2:
 10.2 * 10.3 * 10.0 ↙ 7.1 ← 10.3 *
 9.7 ← 9.5 ← 9.8 ← 8.9 ↗ 9.3 ↘
 beste Teiler 157.4 (12.) 163.7 (15.) 199.9 (11.)
 Trefferlage 2.16 mm links, 0.79 mm hoch
 Streuwert 2.71, horizontal: 3.67, vertikal: 1.11

Unterschrift des Schützen

Ergebnis: **191.6** (183)
 Serien: 93.2 98.4
 Zähler: 10 5 3 2 0 0 0 0 0 0
 Innenzehner: 10
 weiteste: 939 (10), 776 (2), 611 (5)
 beste Teiler 57.0 (20.) 70.7 (8.) 75.1 (4.)
 Trefferlage 0.39 mm rechts, 0.11 mm hoch
 Streuwert 3.05, horizontal: 3.30, vertikal: 2.78

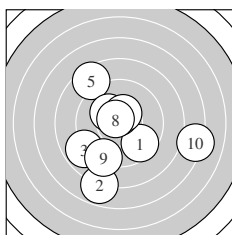
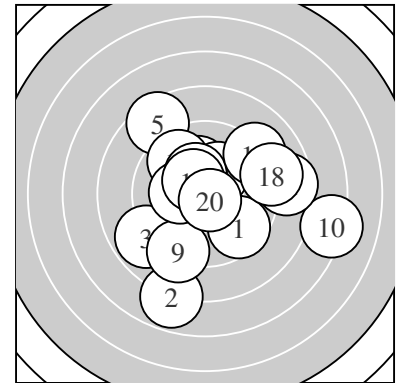

Serie 1:
 9.6 ↘ 7.8 ↓ 8.9 ↙ 10.7 * 8.5 ↖
 10.2 * 10.5 * 10.7 * 9.1 ↓ 7.2 →
 beste Teiler 70.7 (8.) 75.1 (4.) 125.2 (7.)
 Trefferlage 0.19 mm links, 1.05 mm tief
 Streuwert 3.65, horizontal: 3.80, vertikal: 3.51

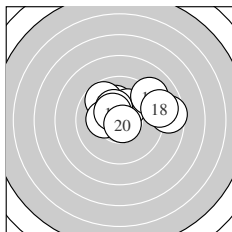

Serie 2:
 8.6 → 10.2 * 9.7 ↖ 10.2 * 10.2 *
 10.3 * 9.1 ↗ 9.0 → 10.4 * 10.7 *
 beste Teiler 57.0 (20.) 129.0 (19.) 157.8 (16.)
 Trefferlage 0.97 mm rechts, 1.28 mm hoch
 Streuwert 2.09, horizontal: 2.79, vertikal: 1.00

Unterschrift des Schützen

Ergebnis: **189.6** (181)
 Serien: 94.7 94.9
 Zähler: 10 5 2 2 1 0 0 0 0 0
 Innenzehner: 7
 weiteste: 1062 (7), 805 (18), 769 (15)
 beste Teiler 62.3 (16.) 86.2 (1.) 87.6 (6.)
 Trefferlage 0.54 mm rechts, 0.60 mm hoch
 Streuwert 3.27, horizontal: 4.49, vertikal: 1.10

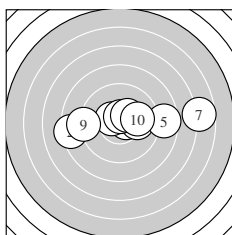
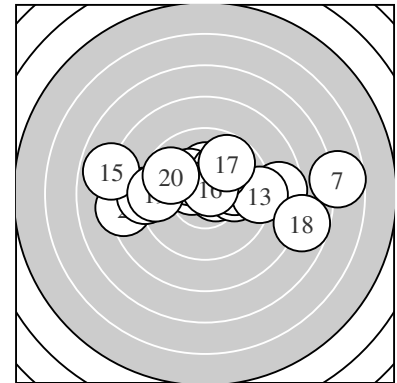

Serie 1:
 10.6 * 8.3 ← 10.5 * 10.0 → 8.6 →
 10.6 * 6.7 → 10.4 * 9.0 ← 10.0 →
 beste Teiler 86.2 (1.) 87.6 (6.) 119.9 (3.)
 Trefferlage 1.08 mm rechts, 0.33 mm hoch
 Streuwert 3.48, horizontal: 4.87, vertikal: 0.67

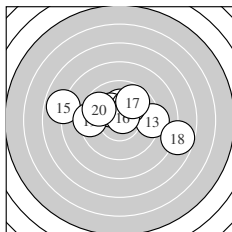

Serie 2:
 10.2 * 10.2 * 9.2 → 10.1 ↗ 7.9 ←
 10.7 * 9.8 ↗ 7.7 → 9.4 ← 9.7 ↖
 beste Teiler 62.3 (16.) 182.6 (12.) 187.0 (11.)
 Trefferlage 0.00 mm , 0.87 mm hoch
 Streuwert 3.17, horizontal: 4.26, vertikal: 1.40

Unterschrift des Schützen

Ergebnis: **202.2** (193)
 Serien: 100.8 101.4
 Zähler: 14 5 1 0 0 0 0 0 0 0
 Innenzehner: 11
 weiteste: 555 (17), 495 (7), 416 (4)
 beste Teiler 56.0 (2.) 84.2 (11.) 99.0 (18.)
 Trefferlage 0.33 mm links, 0.32 mm hoch
 Streuwert 1.78, horizontal: 2.32, vertikal: 0.96

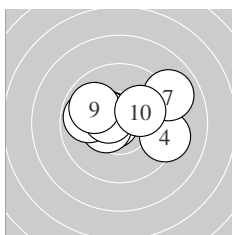
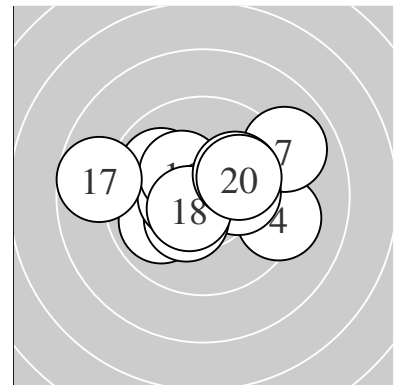

Serie 1:
 10.5 * 10.7 * 10.5 * 9.3 → 10.5 *
 9.8 ← 9.0 ↗ 10.5 * 9.9 ↘ 10.1 ↗
 beste Teiler 56.0 (2.) 108.6 (8.) 119.0 (5.)
 Trefferlage 0.02 mm rechts, 0.53 mm hoch
 Streuwert 1.88, horizontal: 2.48, vertikal: 0.98

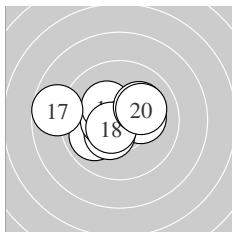

Serie 2:
 10.6 * 9.9 ↙ 10.2 * 10.4 * 10.5 *
 10.3 * 8.7 ← 10.6 * 10.1 ↗ 10.1 ↗
 beste Teiler 84.2 (11.) 99.0 (18.) 121.1 (15.)
 Trefferlage 0.70 mm links, 0.11 mm hoch
 Streuwert 1.71, horizontal: 2.23, vertikal: 0.95

Unterschrift des Schützen

Ergebnis: **193.5** (186)
 Serien: 96.2 97.3
 Zähler: 11 5 3 1 0 0 0 0 0 0
 Innenzehner: 8
 weiteste: 921 (1), 655 (6), 571 (16)
 beste Teiler 120.4 (3.) 136.4 (11.) 137.9 (7.)
 Trefferlage 0.26 mm links, 1.32 mm hoch
 Streuwert 2.61, horizontal: 2.91, vertikal: 2.27

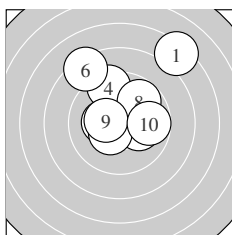
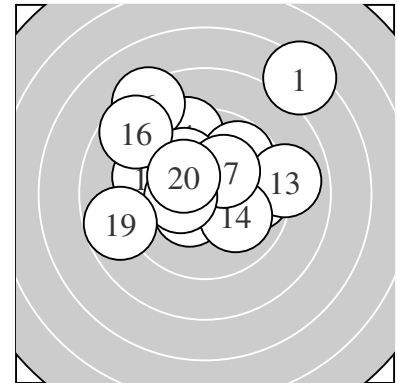

Serie 1:
 7.3 ↗ 10.1 → 10.5 * 9.4 ↑ 10.3 *
 8.3 ↘ 10.4 * 9.8 ↗ 10.4 * 9.7 →
 beste Teiler 120.4 (3.) 137.9 (7.) 142.9 (9.)
 Trefferlage 0.42 mm rechts, 1.86 mm hoch
 Streuwert 2.76, horizontal: 2.75, vertikal: 2.76

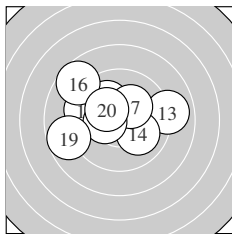

Serie 2:
 10.4 * 9.5 ← 9.0 → 10.0 ↘ 10.1 ↘
 8.7 ↘ 10.2 * 10.4 * 8.7 ← 10.3 *
 beste Teiler 136.4 (11.) 150.9 (18.) 171.1 (20.)
 Trefferlage 0.96 mm links, 0.79 mm hoch
 Streuwert 2.43, horizontal: 3.04, vertikal: 1.60

Unterschrift des Schützen

Ergebnis: **205.3** (197)
 Serien: 101.8 103.5
 Zähler: 17 3 0 0 0 0 0 0 0 0
 Innenzehner: 13
 weiteste: 367 (20), 252 (1), 251 (2)
 beste Teiler 46.3 (12.) 56.3 (18.) 82.8 (4.)
 Trefferlage 0.47 mm rechts, 0.17 mm tief
 Streuwert 1.32, horizontal: 1.67, vertikal: 0.83

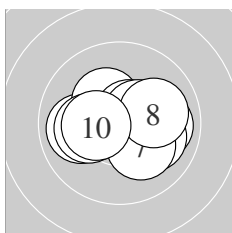
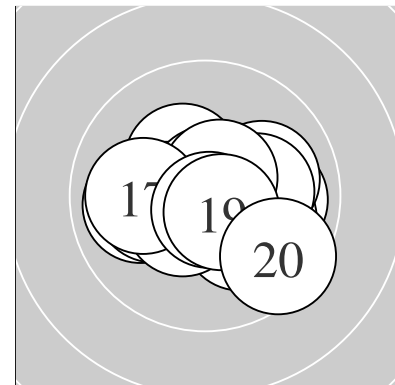

Serie 1:
 9.9 ← 9.9 → 10.3 * 10.6 * 10.1 →
 10.4 * 10.2 * 10.0 → 10.1 ← 10.3 *
 beste Teiler 82.8 (4.) 131.5 (6.) 152.7 (10.)
 Trefferlage 0.30 mm rechts, 0.01 mm tief
 Streuwert 1.44, horizontal: 1.87, vertikal: 0.81

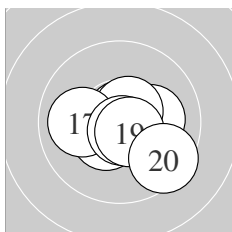

Serie 2:
 10.4 * 10.8 * 10.2 * 10.2 * 10.6 *
 10.5 * 10.0 ← 10.7 * 10.6 * 9.5 ↘
 beste Teiler 46.3 (12.) 56.3 (18.) 89.8 (19.)
 Trefferlage 0.63 mm rechts, 0.33 mm tief
 Streuwert 1.24, horizontal: 1.52, vertikal: 0.87

Unterschrift des Schützen

Ergebnis: **205.5** (195)
 Serien: 102.7 102.8
 Zähler: 15 5 0 0 0 0 0 0 0 0
 Innenzehner: 14
 weiteste: 305 (15), 298 (3), 295 (2)
 beste Teiler 48.0 (17.) 67.7 (5.) 92.9 (18.)
 Trefferlage 0.04 mm rechts, 0.10 mm tief
 Streuwert 1.38, horizontal: 1.57, vertikal: 1.16

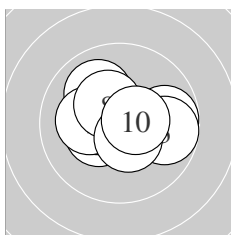
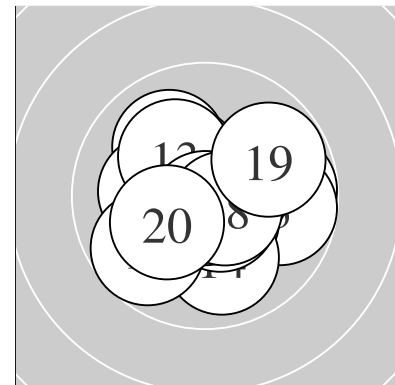

Serie 1:
 10.4 * 9.8 → 9.8 → 10.4 * 10.7 *
 10.0 ↘ 10.2 * 10.4 * 10.5 * 10.5 *
 beste Teiler 67.7 (5.) 106.7 (10.) 112.5 (9.)
 Trefferlage 0.12 mm rechts, 0.21 mm hoch
 Streuwert 1.41, horizontal: 1.80, vertikal: 0.85

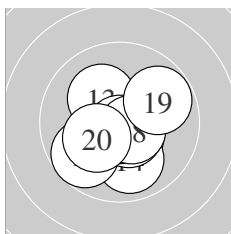

Serie 2:
 10.5 * 10.5 * 10.2 * 9.9 ↓ 9.7 ↙
 10.6 * 10.8 * 10.6 * 9.8 ↗ 10.2 *
 beste Teiler 48.0 (17.) 92.9 (18.) 95.2 (16.)
 Trefferlage 0.03 mm links, 0.42 mm tief
 Streuwert 1.38, horizontal: 1.39, vertikal: 1.37

Unterschrift des Schützen

Ergebnis: **158.7** (148)
 Serien: 81.1 77.6
 Zähler: 1 2 7 5 4 1 0 0 0 0
 Innenzehner: 1
 weiteste: 1284 (8), 1111 (12), 1110 (11)
 beste Teiler 78.1 (10.) 305.3 (14.) 418.2 (6.)
 Trefferlage 3.50 mm links, 3.86 mm hoch
 Streuwert 4.48, horizontal: 5.47, vertikal: 3.21

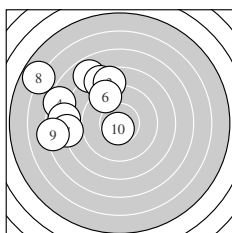
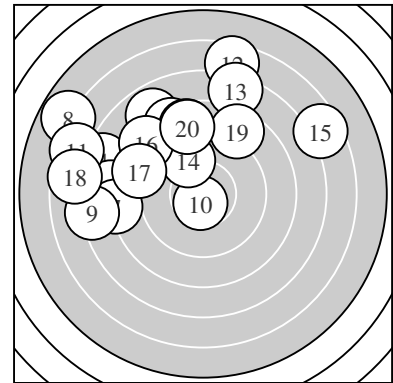

Serie 1:
 7.9 ↘ 8.4 ↘ 8.6 ↑ 7.4 ↖ 7.9 ←
 9.3 ↘ 8.0 ← 5.8 ↖ 7.2 ← 10.6 *
 beste Teiler 78.1 (10.) 418.2 (6.) 579.1 (3.)
 Trefferlage 5.41 mm links, 2.78 mm hoch
 Streuwert 3.53, horizontal: 3.78, vertikal: 3.25

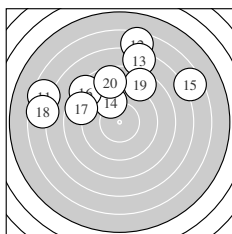

Serie 2:
 6.5 ↖ 6.5 ↑ 7.3 ↑ 9.7 ↘ 6.5 ↗
 8.4 ↘ 8.7 ↖ 6.7 ← 8.6 ↗ 8.7 ↑
 beste Teiler 305.3 (14.) 563.3 (17.) 571.2 (20.)
 Trefferlage 1.60 mm links, 4.94 mm hoch
 Streuwert 4.97, horizontal: 6.39, vertikal: 2.93

Unterschrift des Schützen

Ergebnis: **200.3** (192)
 Serien: 100.7 99.6
 Zähler: 13 6 1 0 0 0 0 0 0 0
 Innenzehner: 8
 weiteste: 504 (2), 473 (15), 412 (8)
 beste Teiler 41.4 (5.) 49.9 (16.) 71.8 (7.)
 Trefferlage 0.25 mm links, 0.47 mm hoch
 Streuwert 1.89, horizontal: 2.59, vertikal: 0.69

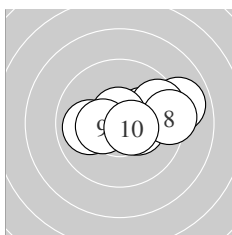
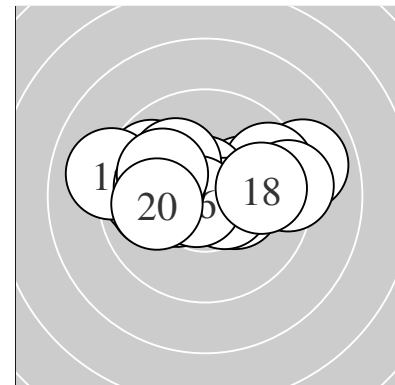

Serie 1:
 10.3 * 8.9 → 10.0 ← 10.2 * 10.8 *
 9.6 → 10.7 * 9.3 → 10.4 * 10.5 *
 beste Teiler 41.4 (5.) 71.8 (7.) 102.8 (10.)
 Trefferlage 1.25 mm rechts, 0.38 mm hoch
 Streuwert 1.72, horizontal: 2.32, vertikal: 0.71

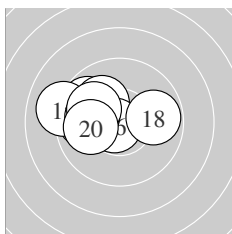

Serie 2:
 9.7 ↖ 9.8 ← 10.3 * 10.1 ↖ 9.1 ←
 10.8 * 10.0 ← 9.8 → 10.0 ↖ 10.0 ←
 beste Teiler 49.9 (16.) 174.3 (13.) 214.4 (14.)
 Trefferlage 1.76 mm links, 0.56 mm hoch
 Streuwert 1.45, horizontal: 1.92, vertikal: 0.71

Unterschrift des Schützen

Ergebnis: **195.3** (185)
 Serien: 99.2 96.1
 Zähler: 9 7 4 0 0 0 0 0 0 0
 Innenzehner: 8
 weiteste: 734 (14), 553 (20), 544 (1)
 beste Teiler 12.5 (3.) 91.1 (9.) 94.9 (6.)
 Trefferlage 0.96 mm links, 0.36 mm hoch
 Streuwert 2.42, horizontal: 3.04, vertikal: 1.56

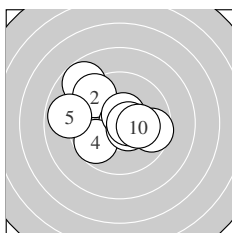
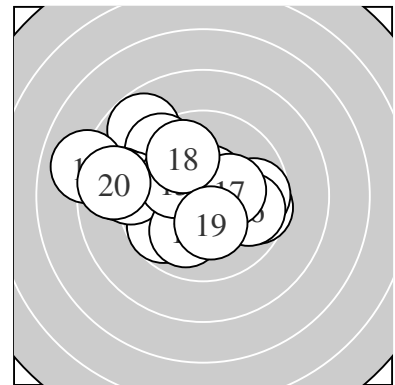

Serie 1:
 8.8 ↘ 9.4 ↘ 10.9 * 9.7 ↙ 8.9 ←
 10.6 * 9.6 → 10.5 * 10.6 * 10.2 *
 beste Teiler 12.5 (3.) 91.1 (9.) 94.9 (6.)
 Trefferlage 0.62 mm links, 0.50 mm hoch
 Streuwert 2.26, horizontal: 2.67, vertikal: 1.75

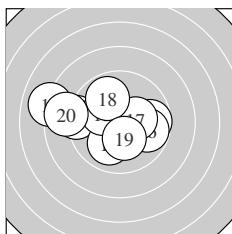

Serie 2:
 9.7 → 9.2 ← 10.0 ↙ 8.0 ← 10.2 *
 9.8 → 10.3 * 9.9 ↘ 10.3 * 8.7 ←
 beste Teiler 166.5 (17.) 172.8 (19.) 193.6 (15.)
 Trefferlage 1.30 mm links, 0.22 mm hoch
 Streuwert 2.67, horizontal: 3.49, vertikal: 1.43

Unterschrift des Schützen

Ergebnis: **196.0** (188)
 Serien: 96.4 99.6
 Zähler: 12 4 4 0 0 0 0 0 0 0
 Innenzehner: 10
 weiteste: 711 (9), 566 (17), 540 (10)
 beste Teiler 95.0 (14.) 120.2 (4.) 123.6 (12.)
 Trefferlage 1.29 mm rechts, 0.23 mm hoch
 Streuwert 2.29, horizontal: 3.09, vertikal: 0.96

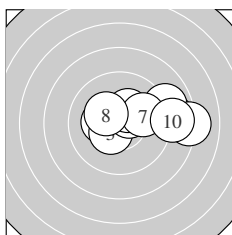
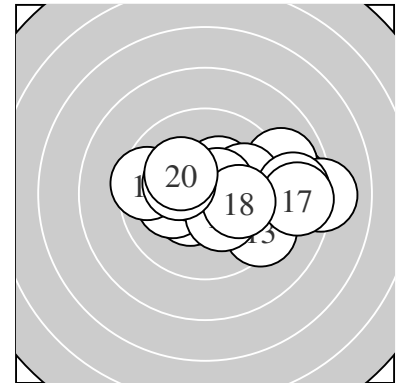

Serie 1:
 8.8 → 10.3 * 10.4 * 10.5 * 10.3 *
 9.0 → 9.9 → 10.3 * 8.1 → 8.8 →
 beste Teiler 120.2 (4.) 130.1 (3.) 153.9 (5.)
 Trefferlage 2.27 mm rechts, 0.57 mm hoch
 Streuwert 2.31, horizontal: 3.18, vertikal: 0.77

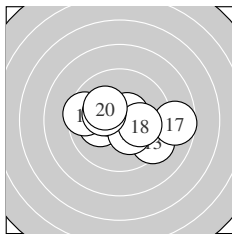

Serie 2:
 10.1 ← 10.5 * 9.3 ↘ 10.6 * 10.3 *
 9.5 ← 8.7 → 10.1 → 10.3 * 10.2 *
 beste Teiler 95.0 (14.) 123.6 (12.) 163.5 (15.)
 Trefferlage 0.32 mm rechts, 0.10 mm tief
 Streuwert 2.12, horizontal: 2.81, vertikal: 1.05

Unterschrift des Schützen

Ergebnis: **205.2** (195)
 Serien: 102.1 103.1
 Zähler: 15 5 0 0 0 0 0 0 0 0
 Innenzehner: 13
 weiteste: 335 (4), 289 (10), 266 (19)
 beste Teiler 60.0 (9.) 80.6 (17.) 95.0 (2.)
 Trefferlage 0.55 mm links, 0.31 mm hoch
 Streuwert 1.29, horizontal: 1.16, vertikal: 1.40

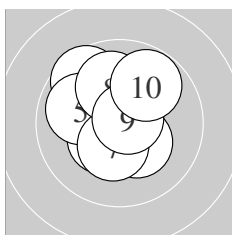
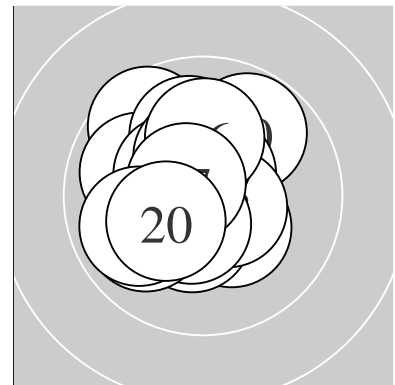

Serie 1:
 10.4 * 10.6 * 10.4 * 9.6 ↘ 9.9 ↖
 10.3 * 10.4 * 10.0 ↑ 10.7 * 9.8 ↗
 beste Teiler 60.0 (9.) 95.0 (2.) 140.4 (1.)
 Trefferlage 0.39 mm links, 0.54 mm hoch
 Streuwert 1.43, horizontal: 1.27, vertikal: 1.58

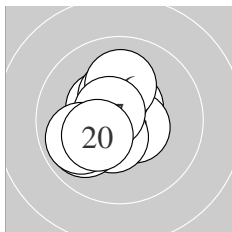

Serie 2:
 10.6 * 10.4 * 10.5 * 10.3 * 10.5 *
 10.1 ↑ 10.6 * 9.9 ↙ 9.9 ↙ 10.3 *
 beste Teiler 80.6 (17.) 96.8 (11.) 101.9 (13.)
 Trefferlage 0.70 mm links, 0.08 mm hoch
 Streuwert 1.16, horizontal: 1.08, vertikal: 1.24

Unterschrift des Schützen

Ergebnis: **208.2** (200)
 Serien: 104.8 103.4
 Zähler: 20 0 0 0 0 0 0 0 0 0
 Innenzehner: 16
 weiteste: 250 (2), 247 (12), 229 (5)
 beste Teiler 47.0 (8.) 68.1 (4.) 70.0 (10.)
 Trefferlage 0.34 mm links, 0.48 mm hoch
 Streuwert 0.97, horizontal: 1.10, vertikal: 0.82

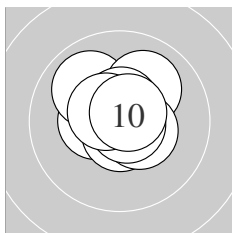
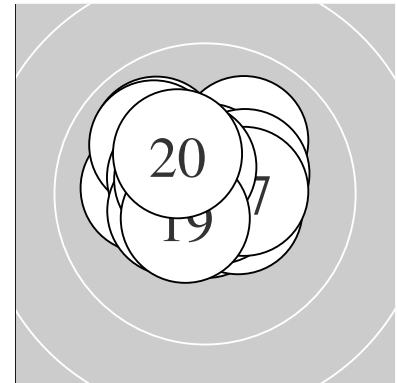

Serie 1:
 10.4 * 10.0 ↘ 10.6 * 10.7 * 10.0 ↗
 10.4 * 10.6 * 10.8 * 10.6 * 10.7 *
 beste Teiler 47.0 (8.) 68.1 (4.) 70.0 (10.)
 Trefferlage 0.04 mm links, 0.50 mm hoch
 Streuwert 0.94, horizontal: 1.00, vertikal: 0.89

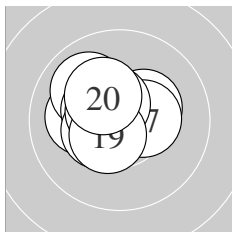

Serie 2:
 10.1 ← 10.0 ↘ 10.3 * 10.4 * 10.4 *
 10.5 * 10.4 * 10.5 * 10.5 * 10.3 *
 beste Teiler 104.6 (18.) 104.7 (16.) 109.4 (19.)
 Trefferlage 0.65 mm links, 0.46 mm hoch
 Streuwert 1.00, horizontal: 1.17, vertikal: 0.80

Unterschrift des Schützen

Ergebnis: **193.8** (185)
 Serien: 96.7 97.1
 Zähler: 8 9 3 0 0 0 0 0 0 0
 Innenzehner: 6
 weiteste: 636 (11), 626 (18), 599 (13)
 beste Teiler 41.2 (5.) 57.6 (16.) 77.6 (12.)
 Trefferlage 2.00 mm rechts, 1.07 mm tief
 Streuwert 2.09, horizontal: 2.40, vertikal: 1.72

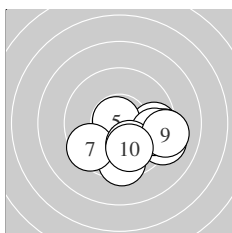
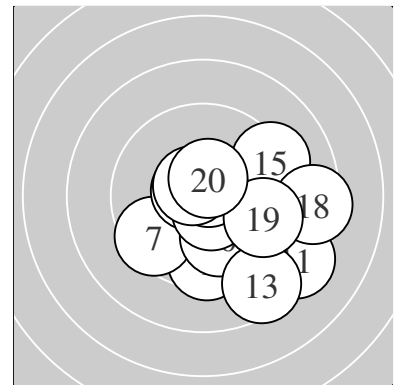

Serie 1:
 9.5 ↓ 9.2 ↘ 9.6 → 9.2 → 10.8 *
 9.6 → 9.5 ↙ 10.1 ↓ 9.2 → 10.0 ↓
 beste Teiler 41.2 (5.) 220.0 (8.) 250.8 (10.)
 Trefferlage 1.81 mm rechts, 1.46 mm tief
 Streuwert 1.88, horizontal: 2.38, vertikal: 1.16

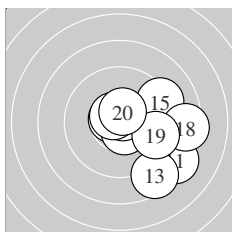

Serie 2:
 8.4 ↘ 10.6 * 8.6 ↘ 10.6 * 9.2 ↗
 10.7 * 10.6 * 8.4 → 9.5 → 10.5 *
 beste Teiler 57.6 (16.) 77.6 (12.) 83.4 (17.)
 Trefferlage 2.18 mm rechts, 0.68 mm tief
 Streuwert 2.34, horizontal: 2.53, vertikal: 2.14

Unterschrift des Schützen

Ergebnis: **183.7** (172)
 Serien: 87.5 96.2
 Zähler: 2 12 4 1 0 1 0 0 0 0
 Innenzehner: 2
 weiteste: 1291 (4), 816 (3), 655 (1)
 beste Teiler 99.5 (11.) 107.0 (13.) 281.1 (14.)
 Trefferlage 2.25 mm links, 0.45 mm hoch
 Streuwert 3.31, horizontal: 4.24, vertikal: 1.98

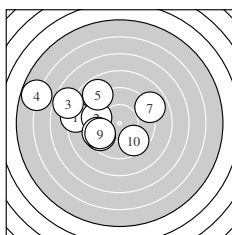
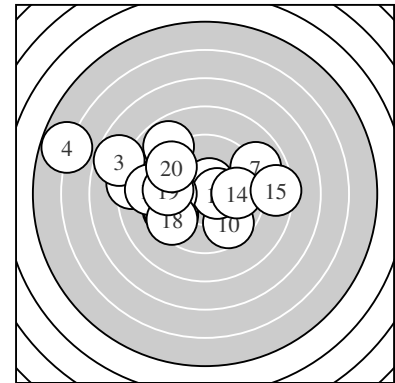

Serie 1:
 8.3 ← 9.6 ← 7.7 ↖ 5.8 ↖ 8.8 ↖
 9.6 ↙ 8.9 ↗ 9.5 ↙ 9.7 ↙ 9.6 ↘
 beste Teiler 325.1 (9.) 329.2 (10.) 337.9 (6.)
 Trefferlage 3.54 mm links, 0.81 mm hoch
 Streuwert 3.77, horizontal: 4.69, vertikal: 2.53

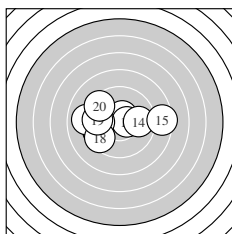

Serie 2:
 10.6 * 9.6 ↙ 10.5 * 9.8 → 8.4 →
 9.8 ← 9.0 ← 9.5 ↙ 9.6 ← 9.4 ↖
 beste Teiler 99.5 (11.) 107.0 (13.) 281.1 (14.)
 Trefferlage 0.96 mm links, 0.09 mm hoch
 Streuwert 2.62, horizontal: 3.50, vertikal: 1.24

Unterschrift des Schützen

Ergebnis: **197.7** (190)
 Serien: 100.4 97.3
 Zähler: 12 6 2 0 0 0 0 0 0 0
 Innenzehner: 8
 weiteste: 623 (17), 547 (14), 465 (4)
 beste Teiler 117.0 (1.) 124.7 (6.) 134.6 (5.)
 Trefferlage 1.00 mm links, 0.06 mm tief
 Streuwert 2.05, horizontal: 2.49, vertikal: 1.50

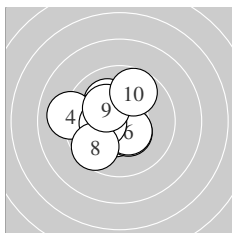
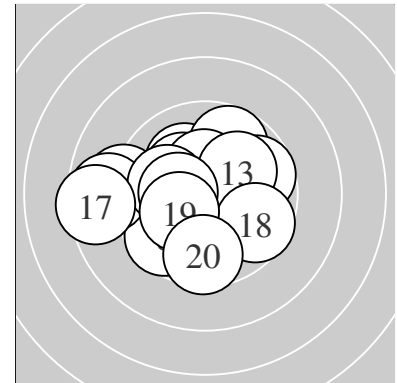

Serie 1:
 10.5 * 10.1 ↖ 10.0 ← 9.1 ← 10.4 *
 10.5 * 10.3 * 9.6 ↗ 10.2 * 9.7 ↗
 beste Teiler 117.0 (1.) 124.7 (6.) 134.6 (5.)
 Trefferlage 1.06 mm links, 0.09 mm hoch
 Streuwert 1.68, horizontal: 1.80, vertikal: 1.54

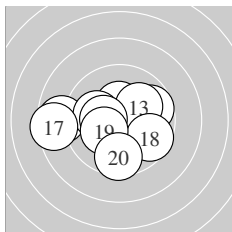

Serie 2:
 9.7 → 10.4 * 10.1 ↗ 8.8 ← 10.1 ←
 10.3 * 8.5 ← 9.6 ↘ 10.2 * 9.6 ↓
 beste Teiler 142.1 (12.) 153.2 (16.) 177.5 (19.)
 Trefferlage 0.94 mm links, 0.22 mm tief
 Streuwert 2.46, horizontal: 3.13, vertikal: 1.51

Unterschrift des Schützen

Ergebnis: **172.5** (163)
 Serien: 85.6 86.9
 Zähler: 1 11 3 1 3 1 0 0 0 0
 Innenzehner: 1
 weiteste: 1323 (5), 1169 (13), 1077 (7)
 beste Teiler 151.5 (15.) 255.1 (18.) 279.2 (19.)
 Trefferlage 2.65 mm links, 0.08 mm hoch
 Streuwert 4.40, horizontal: 5.85, vertikal: 2.10

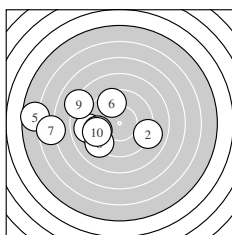
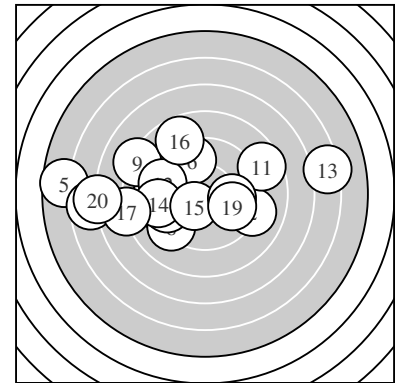

Serie 1:
 9.3 ← 9.1 → 9.0 ← 9.5 ← 5.7 ←
 9.6 ↖ 6.6 ← 9.2 ↗ 8.2 ↖ 9.4 ←
 beste Teiler 339.3 (6.) 359.8 (4.) 380.1 (10.)
 Trefferlage 4.58 mm links, 0.35 mm tief
 Streuwert 3.73, horizontal: 4.86, vertikal: 2.06

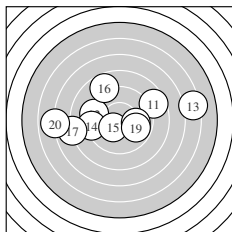

Serie 2:
 8.6 → 9.3 ← 6.3 → 9.2 ← 10.3 *
 8.7 ↖ 7.9 ← 9.9 → 9.8 → 6.9 ←
 beste Teiler 151.5 (15.) 255.1 (18.) 279.2 (19.)
 Trefferlage 0.73 mm links, 0.51 mm hoch
 Streuwert 4.75, horizontal: 6.36, vertikal: 2.15

Unterschrift des Schützen

Ergebnis: **195.5** (189)
 Serien: 100.0 95.5
 Zähler: 9 11 0 0 0 0 0 0 0 0
 Innenzehner: 6
 weiteste: 495 (17), 486 (7), 446 (11)
 beste Teiler 57.2 (2.) 108.5 (8.) 157.3 (4.)
 Trefferlage 0.82 mm links, 0.76 mm hoch
 Streuwert 2.18, horizontal: 2.47, vertikal: 1.84

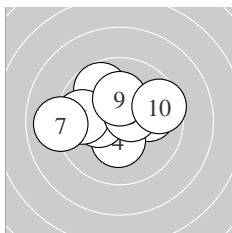
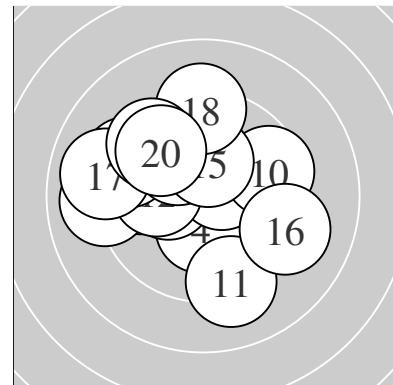

Serie 1:
 10.0 → 10.7 * 9.7 ↖ 10.3 * 10.3 *
 9.7 ← 9.0 ← 10.5 * 10.2 * 9.6 →
 beste Teiler 57.2 (2.) 108.5 (8.) 157.3 (4.)
 Trefferlage 0.53 mm links, 0.55 mm hoch
 Streuwert 1.90, horizontal: 2.43, vertikal: 1.15

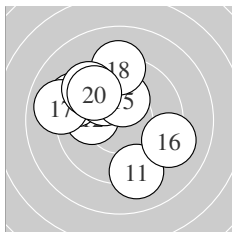

Serie 2:
 9.2 ↓ 10.0 ← 9.3 ↖ 10.1 ↖ 10.3 *
 9.2 → 9.0 ← 9.2 ↑ 9.5 ↖ 9.7 ↖
 beste Teiler 171.9 (15.) 217.7 (14.) 229.2 (12.)
 Trefferlage 1.11 mm links, 0.97 mm hoch
 Streuwert 2.50, horizontal: 2.60, vertikal: 2.39

Unterschrift des Schützen

Ergebnis: **201.0** (190)
 Serien: 101.1 99.9
 Zähler: 12 6 2 0 0 0 0 0 0 0
 Innenzehner: 11
 weiteste: 600 (16), 548 (4), 364 (9)
 beste Teiler 23.0 (10.) 60.8 (20.) 82.2 (13.)
 Trefferlage 0.17 mm links, 0.01 mm hoch
 Streuwert 1.97, horizontal: 2.41, vertikal: 1.38

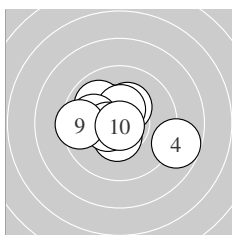
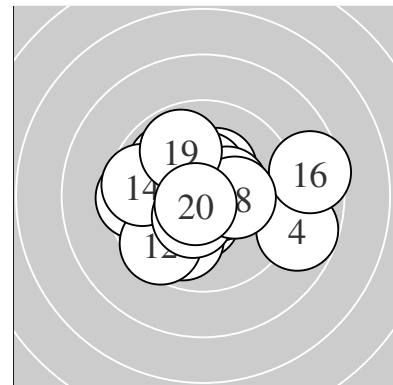

Serie 1:
 10.3 * 9.9 ↘ 10.3 * 8.8 ↗ 10.4 *
 10.0 ← 10.5 * 10.5 * 9.5 ← 10.9 *
 beste Teiler 23.0 (10.) 112.9 (8.) 125.7 (7.)
 Trefferlage 0.42 mm links, 0.23 mm hoch
 Streuwert 1.87, horizontal: 2.36, vertikal: 1.20

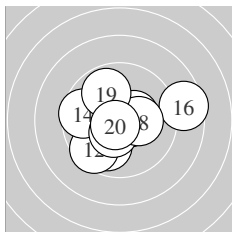

Serie 2:
 9.9 ↓ 9.6 ↙ 10.6 * 9.6 ← 10.4 *
 8.6 → 10.4 * 10.3 * 9.8 ↗ 10.7 *
 beste Teiler 60.8 (20.) 82.2 (13.) 127.9 (17.)
 Trefferlage 0.07 mm rechts, 0.20 mm tief
 Streuwert 2.13, horizontal: 2.57, vertikal: 1.57

Unterschrift des Schützen

Ergebnis: **202.3** (193)
 Serien: 101.1 101.2
 Zähler: 13 7 0 0 0 0 0 0 0 0
 Innenzehner: 11
 weiteste: 462 (5), 362 (16), 343 (11)
 beste Teiler 35.9 (9.) 67.0 (4.) 95.9 (8.)
 Trefferlage 0.70 mm links, 0.36 mm hoch
 Streuwert 1.62, horizontal: 1.84, vertikal: 1.35

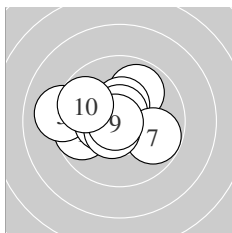
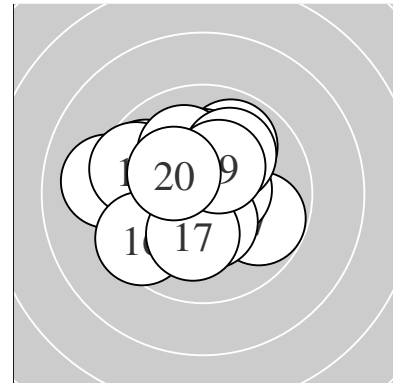

Serie 1:
 9.7 ← 9.9 ↗ 10.4 * 10.7 * 9.1 ←
 10.4 * 9.8 ↘ 10.6 * 10.8 * 9.7 ↖
 beste Teiler 35.9 (9.) 67.0 (4.) 95.9 (8.)
 Trefferlage 0.85 mm links, 0.32 mm hoch
 Streuwert 1.71, horizontal: 2.15, vertikal: 1.11

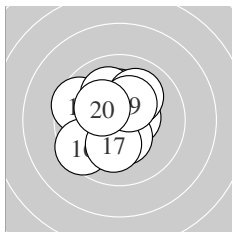

Serie 2:
 9.6 ↖ 10.5 * 10.2 * 10.1 ↗ 10.4 *
 9.5 ↙ 10.2 * 10.0 ↗ 10.4 * 10.3 *
 beste Teiler 108.0 (12.) 139.2 (15.) 150.9 (19.)
 Trefferlage 0.55 mm links, 0.40 mm hoch
 Streuwert 1.60, horizontal: 1.58, vertikal: 1.62

Unterschrift des Schützen

Ergebnis: **188.1** (179)
 Serien: 94.4 93.7
 Zähler: 7 6 6 1 0 0 0 0 0 0
 Innenzehner: 5
 weiteste: 831 (10), 717 (17), 626 (18)
 beste Teiler 64.3 (2.) 78.4 (9.) 98.7 (1.)
 Trefferlage 1.75 mm rechts, 0.81 mm tief
 Streuwert 2.89, horizontal: 4.03, vertikal: 0.65

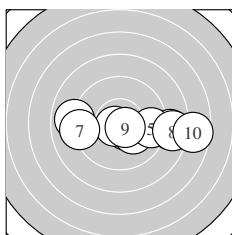
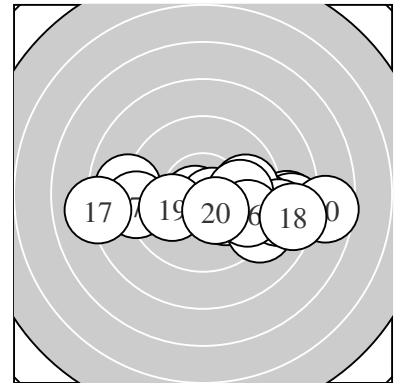

Serie 1:
 10.6 * 10.7 * 8.7 → 10.2 * 9.5 →
 8.9 ← 9.1 ← 8.5 → 10.6 * 7.6 →
 beste Teiler 64.3 (2.) 78.4 (9.) 98.7 (1.)
 Trefferlage 1.60 mm rechts, 0.62 mm tief
 Streuwert 3.10, horizontal: 4.37, vertikal: 0.45

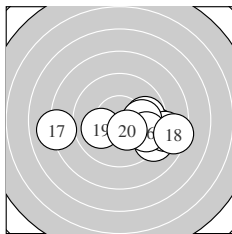

Serie 2:
 9.2 ↘ 9.3 → 9.8 → 8.9 → 10.0 →
 9.6 → 8.1 ← 8.4 → 10.0 ← 10.4 *
 beste Teiler 140.0 (20.) 227.4 (19.) 250.0 (15.)
 Trefferlage 1.91 mm rechts, 1.00 mm tief
 Streuwert 2.81, horizontal: 3.89, vertikal: 0.78

Unterschrift des Schützen

Ergebnis: **201.0** (192)
 Serien: 103.1 97.9
 Zähler: 15 3 1 1 0 0 0 0 0 0
 Innenzehner: 14
 weiteste: 894 (13), 594 (15), 437 (3)
 beste Teiler 5.0 (2.) 5.6 (1.) 72.8 (7.)
 Trefferlage 1.33 mm links, 0.42 mm hoch
 Streuwert 1.97, horizontal: 2.63, vertikal: 0.91

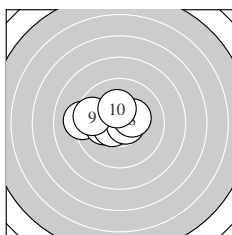
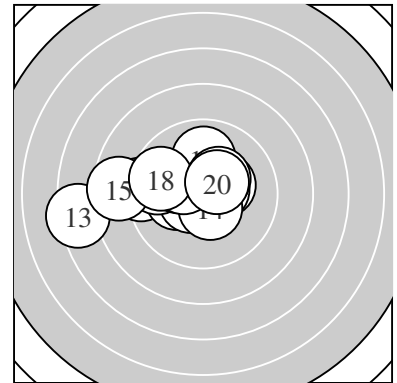

Serie 1:
 10.9 * 10.9 * 9.2 ← 10.4 * 10.2 *
 10.6 * 10.7 * 10.3 * 9.6 ← 10.3 *
 beste Teiler 5.0 (2.) 5.6 (1.) 72.8 (7.)
 Trefferlage 0.95 mm links, 0.31 mm hoch
 Streuwert 1.34, horizontal: 1.78, vertikal: 0.66

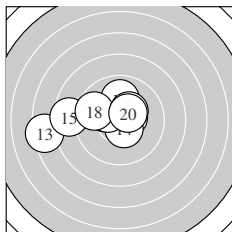

Serie 2:
 10.5 * 10.2 * 7.4 ← 10.5 * 8.6 ←
 10.3 * 10.0 ↑ 9.7 ← 10.3 * 10.4 *
 beste Teiler 106.3 (11.) 111.3 (14.) 128.4 (20.)
 Trefferlage 1.71 mm links, 0.53 mm hoch
 Streuwert 2.49, horizontal: 3.34, vertikal: 1.13

Unterschrift des Schützen

Ergebnis: **199.4** (189)
 Serien: 101.2 98.2
 Zähler: 11 8 0 1 0 0 0 0 0 0
 Innenzehner: 10
 weiteste: 849 (20), 423 (3), 416 (8)
 beste Teiler 12.3 (19.) 37.8 (16.) 70.0 (9.)
 Trefferlage 1.07 mm links, 0.12 mm tief
 Streuwert 2.12, horizontal: 2.39, vertikal: 1.81

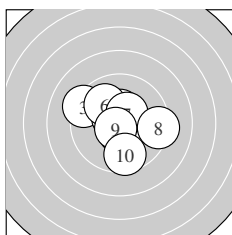
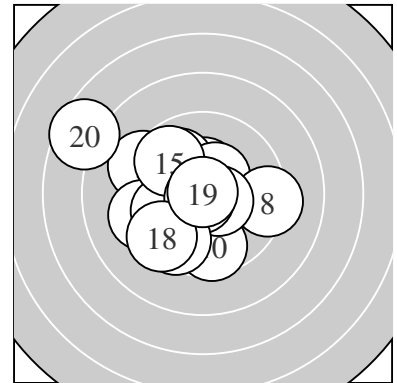

Serie 1:
 10.5 * 10.4 * 9.3 ↖ 10.6 * 10.4 *
 10.0 ↘ 10.4 * 9.3 → 10.7 * 9.6 ↓
 beste Teiler 70.0 (9.) 93.4 (4.) 103.0 (1.)
 Trefferlage 0.06 mm links, 0.01 mm hoch
 Streuwert 1.83, horizontal: 2.00, vertikal: 1.65

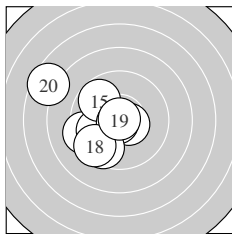

Serie 2:
 10.5 * 9.3 ← 10.4 * 9.9 ← 9.8 ↖
 10.8 * 9.6 ↙ 9.4 ↗ 10.9 * 7.6 ↖
 beste Teiler 12.3 (19.) 37.8 (16.) 106.5 (11.)
 Trefferlage 2.09 mm links, 0.26 mm tief
 Streuwert 2.22, horizontal: 2.39, vertikal: 2.04

Unterschrift des Schützen

Ergebnis: **202.8** (194)
 Serien: 99.0 103.8
 Zähler: 14 6 0 0 0 0 0 0 0 0
 Innenzehner: 11
 weiteste: 413 (3), 412 (5), 400 (8)
 beste Teiler 43.2 (11.) 55.0 (15.) 80.2 (16.)
 Trefferlage 0.00 mm , 0.00 mm
 Streuwert 1.69, horizontal: 1.89, vertikal: 1.47

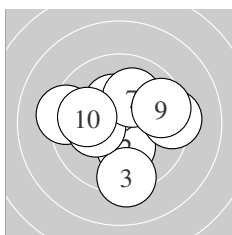
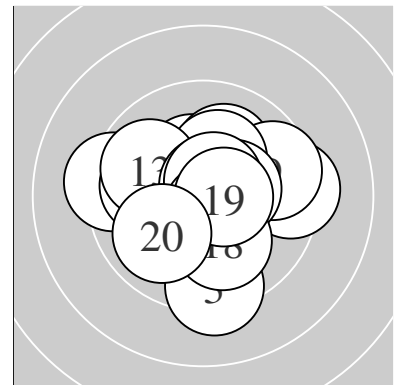

Serie 1:
 10.6 * 10.2 * 9.3 ↓ 10.3 * 9.3 ←
 10.2 * 10.1 ↗ 9.4 → 9.6 → 10.0 ←
 beste Teiler 80.6 (1.) 155.2 (4.) 181.8 (6.)
 Trefferlage 0.05 mm links, 0.01 mm tief
 Streuwert 2.14, horizontal: 2.45, vertikal: 1.77

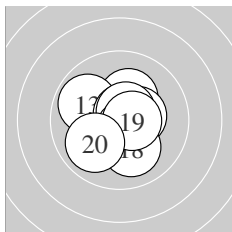

Serie 2:
 10.8 * 10.2 * 9.9 ↖ 10.4 * 10.7 *
 10.6 * 10.6 * 10.1 ↓ 10.6 * 9.9 ↙
 beste Teiler 43.2 (11.) 55.0 (15.) 80.2 (16.)
 Trefferlage 0.07 mm rechts, 0.02 mm hoch
 Streuwert 1.21, horizontal: 1.23, vertikal: 1.20

Unterschrift des Schützen

Ergebnis: **185.2** (176)
 Serien: 94.5 90.7
 Zähler: 5 10 1 4 0 0 0 0 0 0
 Innenzehner: 4
 weiteste: 993 (19), 911 (5), 816 (12)
 beste Teiler 62.9 (18.) 132.1 (9.) 135.0 (20.)
 Trefferlage 2.37 mm links, 1.79 mm tief
 Streuwert 2.94, horizontal: 3.66, vertikal: 1.98

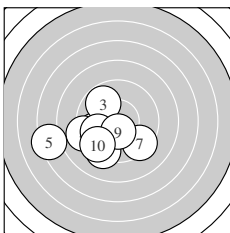
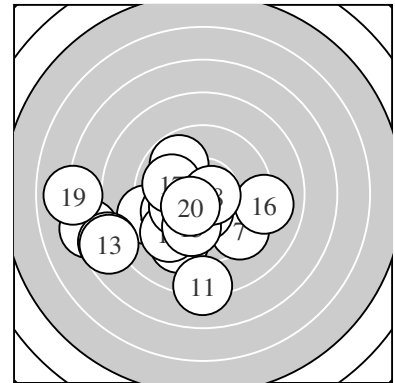

Serie 1:
 10.3 * 9.7 ← 9.8 ↘ 9.1 ← 7.3 ←
 9.3 ↘ 9.4 ↘ 9.8 ← 10.4 * 9.4 ↘
 beste Teiler 132.1 (9.) 153.1 (1.) 284.5 (8.)
 Trefferlage 2.23 mm links, 1.67 mm tief
 Streuwert 2.41, horizontal: 3.00, vertikal: 1.63

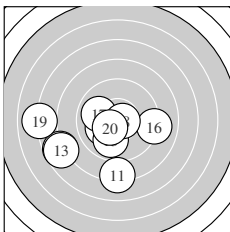

Serie 2:
 8.2 ↓ 7.7 ← 7.7 ← 10.1 ← 9.9 ↘
 9.1 → 9.9 ← 10.7 * 7.0 ← 10.4 *
 beste Teiler 62.9 (18.) 135.0 (20.) 212.0 (14.)
 Trefferlage 2.52 mm links, 1.91 mm tief
 Streuwert 3.51, horizontal: 4.38, vertikal: 2.35

Unterschrift des Schützen