

Ergebnis: **386** (405.4)  
 Serien: 96 97 98 95  
 Zähler: 27 12 1 0 0 0 0 0 0 0  
 Innenzehner: 24  
 weiteste: 518 (32), 448 (35), 419 (10)  
 beste Teiler 8.0 (4.) 10.7 (20.) 60.4 (33.)  
 Trefferlage 0.26 mm rechts, 0.30 mm hoch  
 Streuwert 1.65, horizontal: 2.04, vertikal: 1.12

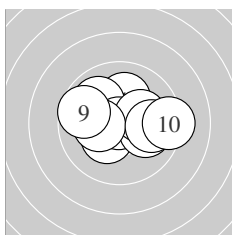

Serie 1:  
 10.1 ↑                      9.9 ↘                      10.3 \*                      10.9 \*                      10.0 →  
 10.2 \*                      10.3 \*                      9.9 →                      9.7 ←                      9.3 →  
 beste Teiler 8.0 (4.) 160.7 (3.) 174.9 (7.)  
 Trefferlage 0.35 mm rechts, 0.30 mm hoch  
 Streuwert 1.80, horizontal: 2.32, vertikal: 1.04

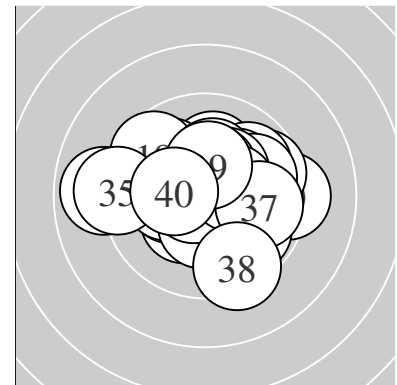
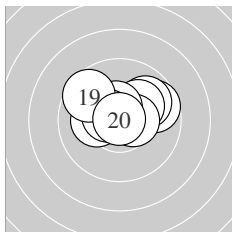

Serie 2:  
 10.3 \*                      9.7 →                      10.2 \*                      9.9 ↗                      10.2 \*  
 10.5 \*                      10.5 \*                      10.5 \*                      9.6 ↘                      10.9 \*  
 beste Teiler 10.7 (20.) 105.6 (18.) 114.2 (17.)  
 Trefferlage 0.02 mm rechts, 0.79 mm hoch  
 Streuwert 1.43, horizontal: 1.88, vertikal: 0.73

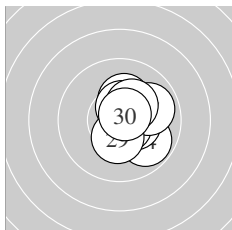

Serie 3:  
 10.2 \*                      10.5 \*                      10.2 \*                      9.8 ↘                      10.4 \*  
 10.7 \*                      9.9 →                      10.3 \*                      10.4 \*                      10.7 \*  
 beste Teiler 66.5 (30.) 71.4 (26.) 113.6 (22.)  
 Trefferlage 1.00 mm rechts, 0.22 mm hoch  
 Streuwert 1.03, horizontal: 0.88, vertikal: 1.16

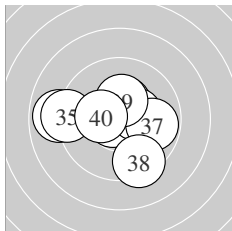

Serie 4:  
 10.0 →                      8.9 ←                      10.7 \*                      10.4 \*                      9.2 ←  
 10.4 \*                      9.8 →                      9.4 ↓                      10.3 \*                      10.3 \*  
 beste Teiler 60.4 (33.) 142.6 (34.) 144.2 (36.)  
 Trefferlage 0.32 mm links, 0.08 mm tief  
 Streuwert 2.16, horizontal: 2.71, vertikal: 1.43

Unterschrift des Schützen

Meyton Elektronik

Ergebnis: **367** (383.9)  
 Serien: 89 93 95 90  
 Zähler: 16 16 7 1 0 0 0 0 0 0  
 Innenzehner: 11  
 weiteste: 928 (12), 722 (40), 695 (8)  
 beste Teiler 9.4 (22.) 57.8 (2.) 73.8 (36.)  
 Trefferlage 1.38 mm links, 0.29 mm hoch  
 Streuwert 2.63, horizontal: 3.22, vertikal: 1.85

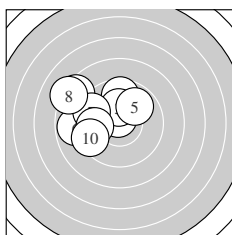
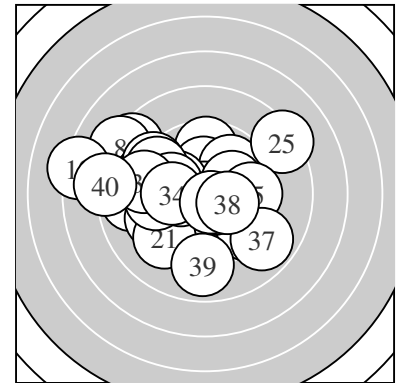

Serie 1:  
 9.6 ↑                      10.7 \*                      10.2 \*                      8.4 ↘                      9.9 ↗  
 8.8 ←                      9.5 ↘                      8.2 ↘                      9.8 ←                      9.4 ←  
 beste Teiler 57.8 (2.) 188.3 (3.) 269.7 (5.)  
 Trefferlage 2.48 mm links, 1.34 mm hoch  
 Streuwert 2.31, horizontal: 2.71, vertikal: 1.82

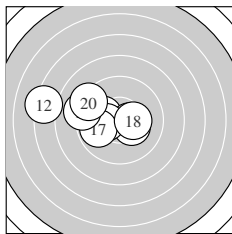

Serie 2:  
 10.1 ↘                      7.2 ↘                      10.5 \*                      9.2 ↘                      10.3 \*  
 10.3 \*                      9.9 ←                      10.3 \*                      9.1 ←                      9.2 ↘  
 beste Teiler 118.2 (13.) 161.1 (16.) 162.1 (18.)  
 Trefferlage 2.31 mm links, 0.50 mm hoch  
 Streuwert 2.46, horizontal: 3.30, vertikal: 1.13

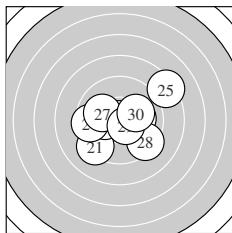

Serie 3:  
 9.2 ↗                      10.9 \*                      10.3 \*                      9.5 ←                      8.3 ↗  
 10.1 →                      10.1 ↘                      9.3 ↘                      10.5 \*                      10.1 →  
 beste Teiler 9.4 (22.) 101.2 (29.) 174.1 (23.)  
 Trefferlage 0.31 mm rechts, 0.11 mm tief  
 Streuwert 2.46, horizontal: 2.92, vertikal: 1.90

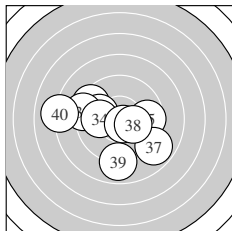

Serie 4:  
 9.4 ↘                      9.9 ↘                      9.2 ←                      10.0 ←                      9.6 →  
 10.7 \*                      8.9 ↘                      10.3 \*                      8.9 ↓                      8.1 ←  
 beste Teiler 73.8 (36.) 174.1 (38.) 237.0 (34.)  
 Trefferlage 1.05 mm links, 0.54 mm tief  
 Streuwert 2.92, horizontal: 3.55, vertikal: 2.10

Unterschrift des Schützen

Meyton Elektronik

Ergebnis: **387** (406.1)  
 Serien: 97 96 97 97  
 Zähler: 28 11 1 0 0 0 0 0 0 0  
 Innenzehner: 22  
 weiteste: 513 (6), 421 (24), 394 (34)  
 beste Teiler 37.6 (33.) 44.6 (32.) 50.0 (1.)  
 Trefferlage 0.20 mm links, 0.39 mm tief  
 Streuwert 1.63, horizontal: 1.78, vertikal: 1.46

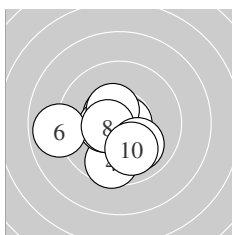
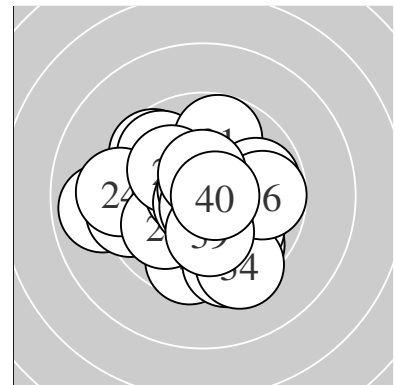

Serie 1:  
 10.8 \*                      10.6 \*                      10.5 \*                      9.6 ↓                      10.4 \*  
 8.9 ←                      10.5 \*                      10.5 \*                      10.0 ↘                      10.0 ↘  
 beste Teiler 50.0 (1.) 85.7 (2.) 103.3 (8.)  
 Trefferlage 0.70 mm links, 0.71 mm tief  
 Streuwert 1.58, horizontal: 1.80, vertikal: 1.33

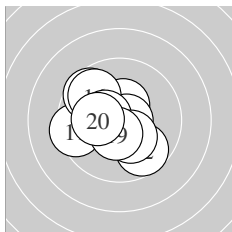

Serie 2:  
 9.4 ←                      9.7 ↘                      9.6 ↖                      10.4 \*                      10.7 \*  
 9.8 ↖                      10.4 \*                      10.3 \*                      10.5 \*                      10.2 \*  
 beste Teiler 59.1 (15.) 117.6 (19.) 126.3 (17.)  
 Trefferlage 0.80 mm links, 0.00 mm  
 Streuwert 1.65, horizontal: 1.77, vertikal: 1.52

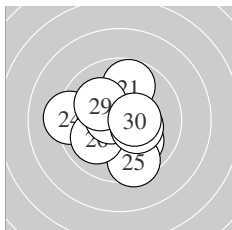

Serie 3:  
 9.8 ↑                      10.0 ↘                      10.6 \*                      9.3 ←                      9.5 ↓  
 10.0 ↖                      10.7 \*                      10.3 \*                      10.1 ↖                      10.4 \*  
 beste Teiler 75.5 (27.) 83.0 (23.) 127.0 (30.)  
 Trefferlage 0.29 mm links, 0.29 mm tief  
 Streuwert 1.81, horizontal: 1.89, vertikal: 1.72

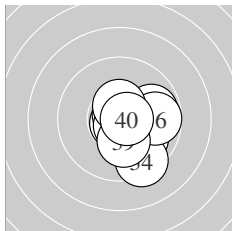

Serie 4:  
 10.0 ↘                      10.8 \*                      10.8 \*                      9.4 ↘                      9.8 →  
 9.7 →                      10.7 \*                      10.5 \*                      10.2 \*                      10.7 \*  
 beste Teiler 37.6 (33.) 44.6 (32.) 55.0 (37.)  
 Trefferlage 1.00 mm rechts, 0.56 mm tief  
 Streuwert 1.31, horizontal: 1.24, vertikal: 1.39

Unterschrift des Schützen

Meyton Elektronik

Ergebnis:	<b>354</b>	(370.1)
Serien:	84 88 89 93	
Zähler:	11 16 9 4 0 0 0 0 0 0	
Innenzehner:	5	
weiteste:	933 (9), 819 (3), 774 (1)	
beste Teiler	69.8 (35.) 74.3 (27.) 108.1 (19.)	
Trefferlage	0.58 mm rechts, 0.70 mm tief	
Streuwert	3.38, horizontal: 3.73, vertikal: 3.00	

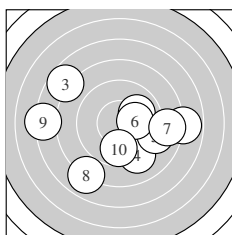
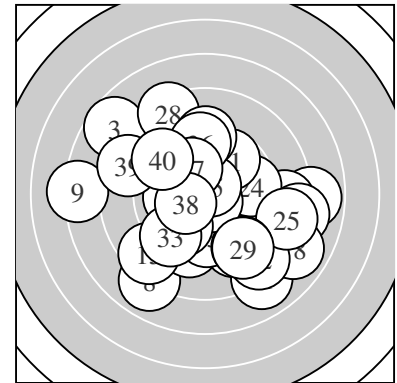

Serie 1:	7.9 →	10.0 ↗	7.7 ↘	9.2 ↘	9.1 →
	10.2 *	8.6 →	8.0 ↙	7.2 ←	9.7 ↓
beste Teiler	190.0 (6.)	242.0 (2.)	304.2 (10.)		
Trefferlage	0.38 mm rechts, 0.89 mm tief				
Streuwert	4.44, horizontal: 5.49, vertikal: 3.05				

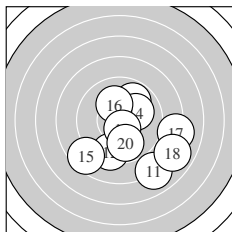

Serie 2:	8.0 ↘	9.3 ↓	9.8 ↗	10.1 ↗	8.6 ↙
	10.1 ↗	8.2 →	7.9 ↘	10.5 *	9.8 ↓
beste Teiler	108.1 (19.)	204.2 (16.)	220.0 (14.)		
Trefferlage	1.61 mm rechts, 1.84 mm tief				
Streuwert	3.16, horizontal: 3.42, vertikal: 2.89				

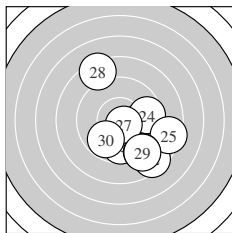

Serie 3:	10.0 →	8.5 ↘	9.7 ↓	9.6 →	8.5 →
	9.1 ↘	10.7 *	8.4 ↗	9.0 ↘	9.8 ↙
beste Teiler	74.3 (27.)	235.7 (21.)	288.0 (30.)		
Trefferlage	1.73 mm rechts, 1.42 mm tief				
Streuwert	2.89, horizontal: 2.65, vertikal: 3.11				

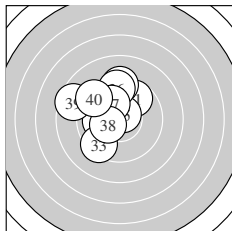

Serie 4:	9.7 ↗	10.0 ←	9.4 ↙	9.3 ↑	10.7 *
	9.5 ↑	10.1 ↘	10.3 *	8.6 ↘	9.3 ↘
beste Teiler	69.8 (35.)	157.4 (38.)	211.1 (37.)		
Trefferlage	1.41 mm links, 1.34 mm hoch				
Streuwert	2.15, horizontal: 2.10, vertikal: 2.21				

Unterschrift des Schützen

Ergebnis: **390** (407.2)  
 Serien: 98 98 96 98  
 Zähler: 30 10 0 0 0 0 0 0 0 0  
 Innenzehner: 21  
 weiteste: 410 (23), 358 (29), 329 (26)  
 beste Teiler 40.3 (32.) 41.0 (35.) 50.9 (39.)  
 Trefferlage 0.14 mm links, 0.16 mm hoch  
 Streuwert 1.52, horizontal: 1.58, vertikal: 1.45

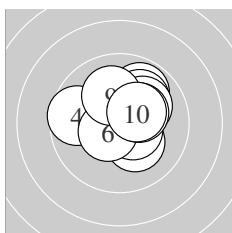
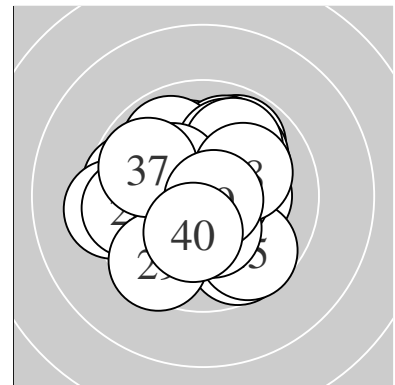

Serie 1:  
 10.2 \*                      10.5 \*                      9.8 ↗                      9.6 ←                      10.0 ↗  
 10.5 \*                      10.1 ↗                      10.3 \*                      10.1 ↑                      10.3 \*  
 beste Teiler 108.2 (6.) 113.6 (2.) 153.1 (10.)  
 Trefferlage 0.49 mm rechts, 0.71 mm hoch  
 Streuwert 1.43, horizontal: 1.59, vertikal: 1.24

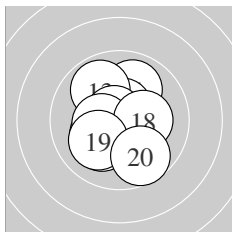

Serie 2:  
 10.0 ↗                      10.6 \*                      9.9 ↘                      10.1 ✓                      10.7 \*  
 10.2 \*                      10.4 \*                      10.2 \*                      10.1 ✓                      9.7 ↘  
 beste Teiler 54.5 (15.) 94.9 (12.) 137.2 (17.)  
 Trefferlage 0.31 mm links, 0.12 mm tief  
 Streuwert 1.51, horizontal: 1.35, vertikal: 1.65

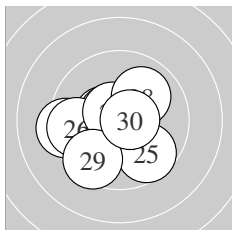

Serie 3:  
 10.5 \*                      10.6 \*                      9.3 ←                      10.4 \*                      9.7 ↘  
 9.6 ←                      10.6 \*                      10.0 ↗                      9.5 ✓                      10.6 \*  
 beste Teiler 78.0 (30.) 82.2 (27.) 92.5 (22.)  
 Trefferlage 0.80 mm links, 0.45 mm tief  
 Streuwert 1.72, horizontal: 1.97, vertikal: 1.43

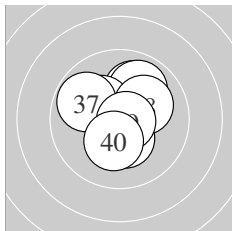

Serie 4:  
 10.0 ↗                      10.8 \*                      9.9 ↗                      10.3 \*                      10.8 \*  
 10.3 \*                      9.8 ↘                      10.1 ↗                      10.8 \*                      10.3 \*  
 beste Teiler 40.3 (32.) 41.0 (35.) 50.9 (39.)  
 Trefferlage 0.04 mm rechts, 0.51 mm hoch  
 Streuwert 1.31, horizontal: 1.29, vertikal: 1.33

Unterschrift des Schützen

Meyton Elektronik

Ergebnis: **351** (370.1)  
 Serien: 82 90 88 91  
 Zähler: 14 10 10 5 1 0 0 0 0 0  
 Innenzehner: 10  
 weiteste: 1072 (2), 962 (15), 838 (3)  
 beste Teiler 74.7 (34.) 76.5 (29.) 112.2 (38.)  
 Trefferlage 1.15 mm links, 0.13 mm tief  
 Streuwert 3.43, horizontal: 4.13, vertikal: 2.53

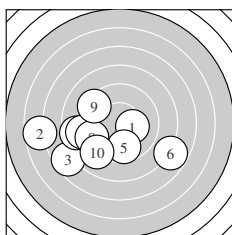
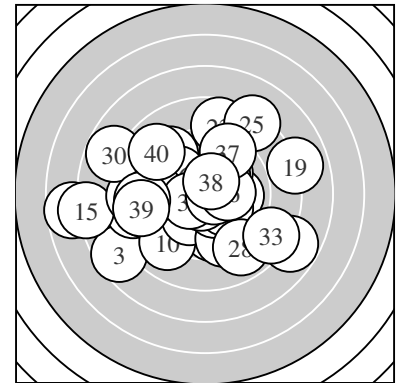

Serie 1:  
 10.2 \*                      6.7 ←                      7.6 ↙                      8.6 ←                      9.7 ↓  
 7.8 ↘                      8.9 ←                      9.3 ↙                      9.3 ↘                      9.0 ↙  
 beste Teiler 176.5 (1.) 320.2 (5.) 408.5 (9.)  
 Trefferlage 2.92 mm links, 1.96 mm tief  
 Streuwert 3.77, horizontal: 4.91, vertikal: 2.08

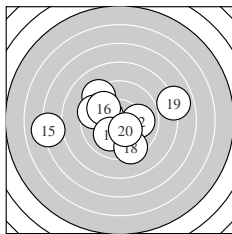

Serie 2:  
 10.2 \*                      10.0 →                      9.3 ↘                      9.5 ↖                      7.1 ←  
 9.9 ↘                      10.1 ↙                      9.4 ↓                      7.9 →                      10.4 \*  
 beste Teiler 148.0 (20.) 186.6 (11.) 224.1 (17.)  
 Trefferlage 0.89 mm links, 0.05 mm hoch  
 Streuwert 3.42, horizontal: 4.37, vertikal: 2.08

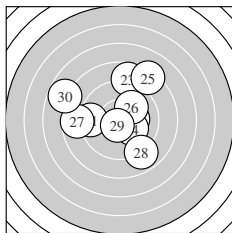

Serie 3:  
 9.4 ←                      10.2 \*                      8.7 ↑                      10.2 \*                      8.2 ↗  
 10.0 ↗                      8.7 ←                      8.9 ↘                      10.6 \*                      7.8 ↖  
 beste Teiler 76.5 (29.) 177.4 (22.) 195.3 (24.)  
 Trefferlage 0.44 mm links, 0.99 mm hoch  
 Streuwert 3.46, horizontal: 3.81, vertikal: 3.08

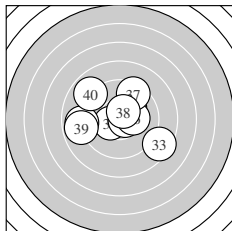

Serie 4:  
 10.1 ↗                      10.4 \*                      8.5 ↘                      10.7 \*                      8.9 ←  
 10.2 \*                      9.4 ↗                      10.5 \*                      8.9 ←                      8.9 ↘  
 beste Teiler 74.7 (34.) 112.2 (38.) 135.6 (32.)  
 Trefferlage 0.37 mm links, 0.37 mm hoch  
 Streuwert 2.81, horizontal: 3.40, vertikal: 2.05

Unterschrift des Schützen

Meyton Elektronik

Ergebnis: **375** (391.5)  
 Serien: 93 90 95 97  
 Zähler: 21 13 6 0 0 0 0 0 0 0  
 Innenzehner: 14  
 weiteste: 726 (39), 657 (12), 631 (19)  
 beste Teiler 44.0 (22.) 52.3 (35.) 74.7 (38.)  
 Trefferlage 0.50 mm links, 0.43 mm tief  
 Streuwert 2.37, horizontal: 2.05, vertikal: 2.66

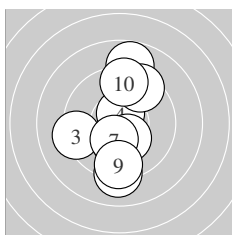
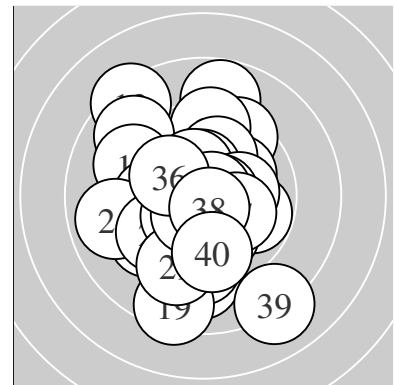

Serie 1:  
 10.3 \* 9.1 ↓ 9.3 ← 10.6 \* 8.8 ↑  
 10.3 \* 10.3 \* 9.4 ↗ 9.4 ↓ 9.4 ↑  
 beste Teiler 91.3 (4.) 157.8 (6.) 159.3 (7.)  
 Trefferlage 0.11 mm links, 0.08 mm tief  
 Streuwert 2.61, horizontal: 1.57, vertikal: 3.34

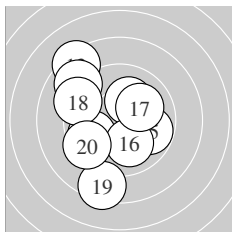

Serie 2:  
 10.2 \* 8.3 ↘ 9.8 ← 8.9 ↘ 9.8 →  
 10.0 ↓ 10.1 ↗ 9.2 ↘ 8.4 ↓ 9.4 ←  
 beste Teiler 199.0 (11.) 222.4 (17.) 230.1 (16.)  
 Trefferlage 1.27 mm links, 0.04 mm hoch  
 Streuwert 2.96, horizontal: 2.62, vertikal: 3.26

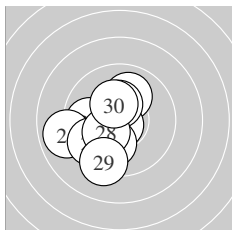

Serie 3:  
 10.0 ↗ 10.8 \* 9.8 ← 8.9 ← 9.6 ←  
 10.4 \* 10.1 ↓ 10.3 \* 9.3 ↓ 10.3 \*  
 beste Teiler 44.0 (22.) 148.2 (26.) 160.0 (30.)  
 Trefferlage 1.36 mm links, 0.58 mm tief  
 Streuwert 1.81, horizontal: 1.69, vertikal: 1.91

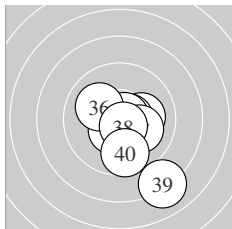

Serie 4:  
 10.5 \* 10.5 \* 10.1 → 10.6 \* 10.7 \*  
 10.1 ↘ 10.1 ↘ 10.7 \* 8.0 ↓ 9.7 ↓  
 beste Teiler 52.3 (35.) 74.7 (38.) 87.5 (34.)  
 Trefferlage 0.73 mm rechts, 1.13 mm tief  
 Streuwert 1.86, horizontal: 1.62, vertikal: 2.08

Unterschrift des Schützen

Ergebnis: **346** (362.7)  
 Serien: 90 82 86 88  
 Zähler: 8 17 9 5 1 0 0 0 0 0  
 Innenzehner: 6  
 weiteste: 1008 (40), 968 (14), 962 (20)  
 beste Teiler 120.8 (11.) 142.6 (4.) 145.6 (39.)  
 Trefferlage 0.28 mm rechts, 0.27 mm hoch  
 Streuwert 3.82, horizontal: 4.68, vertikal: 2.70

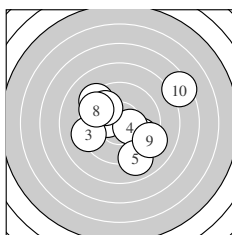
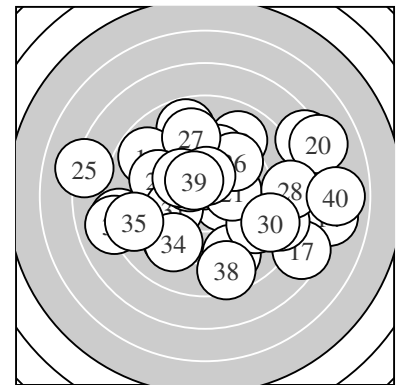

Serie 1:  
 10.3 \* 9.7 ↘ 9.3 ← 10.4 \* 9.0 ↓  
 9.3 ↙ 9.9 ↘ 9.6 ↖ 9.2 ↘ 7.4 ↗  
 beste Teiler 142.6 (4.) 161.5 (1.) 267.3 (7.)  
 Trefferlage 0.42 mm rechts, 0.12 mm hoch  
 Streuwert 3.23, horizontal: 3.73, vertikal: 2.65

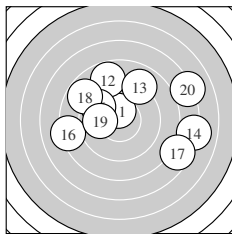

Serie 2:  
 10.5 \* 8.8 ↑ 9.0 ↗ 7.1 → 9.7 ↘  
 8.2 ← 7.5 ↘ 8.8 ↖ 9.9 ← 7.1 →  
 beste Teiler 120.8 (11.) 251.2 (19.) 324.3 (15.)  
 Trefferlage 1.03 mm rechts, 1.18 mm hoch  
 Streuwert 4.61, horizontal: 5.76, vertikal: 3.05

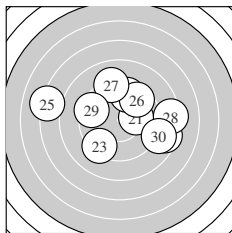

Serie 3:  
 10.1 → 8.5 ↘ 9.3 ↙ 9.6 ↑ 7.1 ←  
 9.6 ↗ 9.1 ↑ 8.3 → 9.4 ↖ 8.8 ↘  
 beste Teiler 213.7 (21.) 338.7 (24.) 344.1 (26.)  
 Trefferlage 0.61 mm rechts, 0.73 mm hoch  
 Streuwert 3.91, horizontal: 4.91, vertikal: 2.54

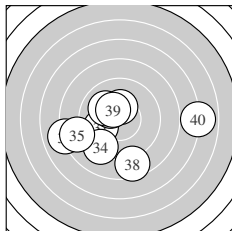

Serie 4:  
 9.9 ← 10.3 \* 8.0 ← 9.2 ↙ 8.6 ←  
 10.0 ↘ 10.3 \* 8.6 ↓ 10.4 \* 6.9 →  
 beste Teiler 145.6 (39.) 154.2 (37.) 157.8 (32.)  
 Trefferlage 0.93 mm links, 0.93 mm tief  
 Streuwert 3.69, horizontal: 4.61, vertikal: 2.44

Unterschrift des Schützen

Meyton Elektronik