

Ergebnis: **167.2** (158)
 Serien: 83.4 83.8
 Zähler: 2 6 5 3 3 1 0 0 0 0
 Innenzehner: 2
 weiteste: 1403 (20), 1201 (2), 1184 (13)
 beste Teiler 51.3 (16.) 176.7 (17.) 258.6 (10.)
 Trefferlage 1.61 mm rechts, 1.17 mm tief
 Streuwert 5.14, horizontal: 6.24, vertikal: 3.72

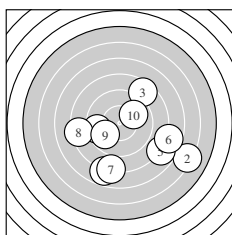

Serie 1:
 7.8 ↙ 6.1 → 8.5 ↗ 9.5 ← 7.8 ↘
 7.7 → 8.0 ↓ 8.3 ← 9.8 ↖ 9.9 ↗
 beste Teiler 258.6 (10.) 289.2 (9.) 365.5 (4.)
 Trefferlage 1.47 mm rechts, 2.49 mm tief
 Streuwert 4.80, horizontal: 5.58, vertikal: 3.86

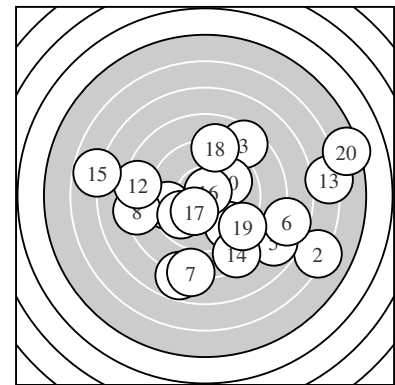
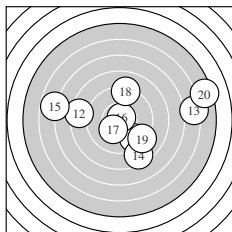

Serie 2:
 9.5 ↘ 8.4 ← 6.2 → 8.5 ↘ 6.8 ←
 10.7 * 10.2 * 9.1 ↑ 9.1 ↘ 5.3 →
 beste Teiler 51.3 (16.) 176.7 (17.) 355.4 (11.)
 Trefferlage 1.74 mm rechts, 0.13 mm hoch
 Streuwert 5.55, horizontal: 7.15, vertikal: 3.25

Unterschrift des Schützen

Ergebnis: **188.2** (179)
 Serien: 92.0 96.2
 Zähler: 5 9 6 0 0 0 0 0 0 0
 Innenzehner: 5
 weiteste: 736 (5), 687 (6), 638 (10)
 beste Teiler 86.2 (16.) 89.3 (7.) 149.4 (17.)
 Trefferlage 1.18 mm links, 0.64 mm hoch
 Streuwert 2.98, horizontal: 3.27, vertikal: 2.66

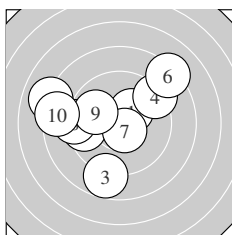
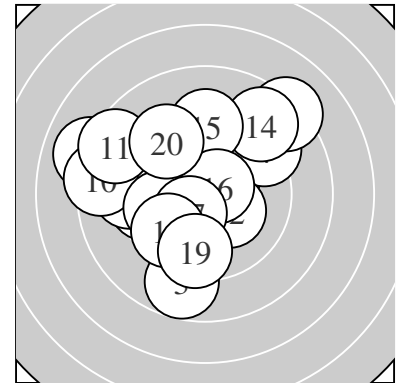

Serie 1:
 10.3 * 9.5 ← 8.8 ↓ 9.2 ↗ 8.0 ↖
 8.2 ↗ 10.6 * 9.1 ← 9.9 ↖ 8.4 ←
 beste Teiler 89.3 (7.) 171.8 (1.) 266.2 (9.)
 Trefferlage 1.51 mm links, 0.67 mm hoch
 Streuwert 3.42, horizontal: 4.02, vertikal: 2.68

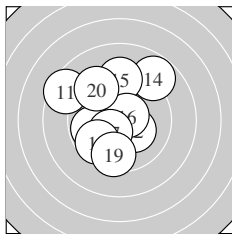

Serie 2:
 8.5 ↖ 10.2 * 9.8 ← 8.8 ↗ 9.3 ↑
 10.6 * 10.4 * 9.7 ↗ 9.5 ↓ 9.4 ↖
 beste Teiler 86.2 (16.) 149.4 (17.) 177.2 (12.)
 Trefferlage 0.86 mm links, 0.61 mm hoch
 Streuwert 2.63, horizontal: 2.48, vertikal: 2.78

Unterschrift des Schützen

Ergebnis: **200.1** (190)
 Serien: 102.1 98.0
 Zähler: 12 6 2 0 0 0 0 0 0 0
 Innenzehner: 8
 weiteste: 572 (15), 520 (16), 362 (9)
 beste Teiler 26.1 (8.) 57.0 (7.) 69.8 (6.)
 Trefferlage 0.42 mm links, 0.12 mm hoch
 Streuwert 1.97, horizontal: 2.35, vertikal: 1.49

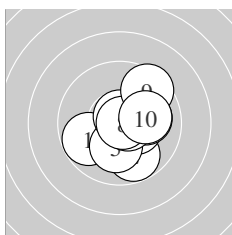
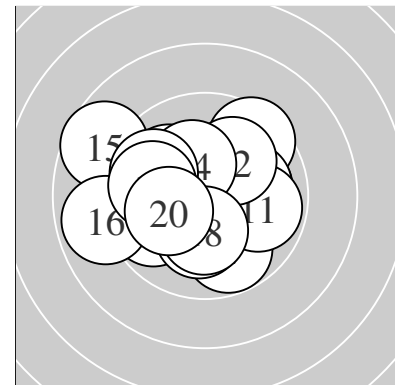

Serie 1:
 9.8 ↙ 9.8 ↘ 10.4 * 10.1 → 10.2 *
 10.7 * 10.7 * 10.8 * 9.5 ↗ 10.1 →
 beste Teiler 26.1 (8.) 57.0 (7.) 69.8 (6.)
 Trefferlage 0.73 mm rechts, 0.22 mm tief
 Streuwert 1.52, horizontal: 1.51, vertikal: 1.52

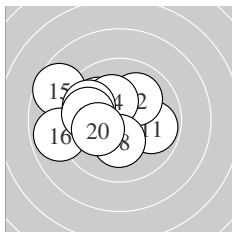

Serie 2:
 9.9 → 10.1 ↗ 10.0 ↖ 10.3 * 8.7 ↖
 8.9 ← 9.8 ↖ 10.2 * 9.9 ← 10.2 *
 beste Teiler 174.0 (14.) 176.1 (18.) 199.4 (20.)
 Trefferlage 1.57 mm links, 0.46 mm hoch
 Streuwert 2.06, horizontal: 2.52, vertikal: 1.46

Unterschrift des Schützen

Ergebnis: **195.2** (185)
 Serien: 96.5 98.7
 Zähler: 8 9 3 0 0 0 0 0 0 0
 Innenzehner: 6
 weiteste: 569 (4), 559 (11), 508 (7)
 beste Teiler 61.5 (18.) 157.5 (5.) 158.6 (19.)
 Trefferlage 1.78 mm rechts, 0.85 mm hoch
 Streuwert 1.90, horizontal: 2.12, vertikal: 1.65

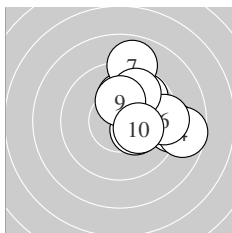
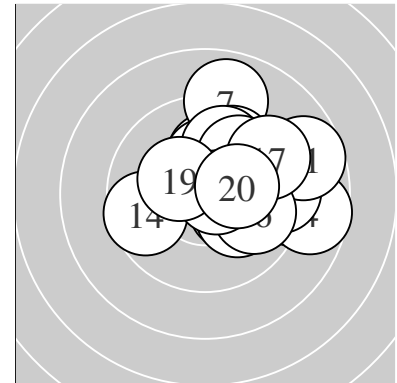

Serie 1:
 9.8 ↗ 10.1 ↑ 9.1 → 8.7 → 10.3 *
 9.4 → 8.9 ↑ 9.8 ↗ 10.2 * 10.2 *
 beste Teiler 157.5 (5.) 179.0 (10.) 180.1 (9.)
 Trefferlage 2.22 mm rechts, 1.06 mm hoch
 Streuwert 1.91, horizontal: 1.88, vertikal: 1.93

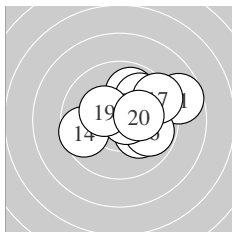

Serie 2:
 8.7 → 9.9 ↑ 9.9 ↗ 9.6 ← 10.1 ↘
 9.8 → 9.4 → 10.7 * 10.3 * 10.3 *
 beste Teiler 61.5 (18.) 158.6 (19.) 175.8 (20.)
 Trefferlage 1.35 mm rechts, 0.64 mm hoch
 Streuwert 1.93, horizontal: 2.36, vertikal: 1.39

Unterschrift des Schützen

Ergebnis: **193.2** (184)
 Serien: 99.9 93.3
 Zähler: 8 9 2 1 0 0 0 0 0 0
 Innenzehner: 5
 weiteste: 797 (16), 685 (5), 527 (20)
 beste Teiler 17.4 (9.) 65.1 (8.) 98.8 (4.)
 Trefferlage 0.09 mm rechts, 0.65 mm hoch
 Streuwert 2.71, horizontal: 3.58, vertikal: 1.36

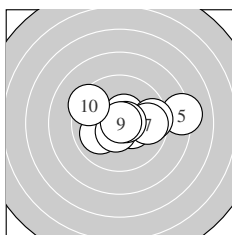
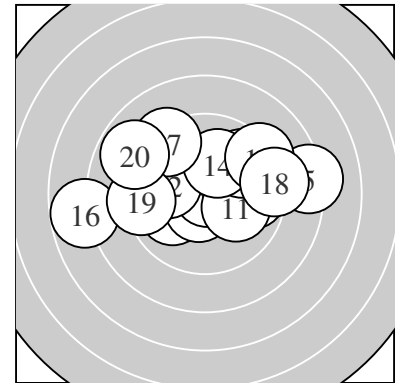

Serie 1:
 10.0 ↙ 10.4 * 10.5 * 10.6 * 8.2 →
 9.5 → 9.7 → 10.7 * 10.9 * 9.4 ↘
 beste Teiler 17.4 (9.) 65.1 (8.) 98.8 (4.)
 Trefferlage 1.00 mm rechts, 0.19 mm hoch
 Streuwert 2.16, horizontal: 2.91, vertikal: 0.94

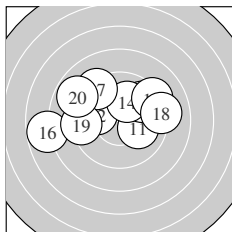

Serie 2:
 10.1 ↘ 9.9 ↖ 9.7 ↗ 10.1 ↗ 9.2 ↗
 7.8 ← 9.3 ↘ 9.1 → 9.3 ← 8.8 ↘
 beste Teiler 215.7 (14.) 219.9 (11.) 256.1 (12.)
 Trefferlage 0.82 mm links, 1.11 mm hoch
 Streuwert 3.10, horizontal: 4.08, vertikal: 1.60

Unterschrift des Schützen

Ergebnis: **170.0** (161)
 Serien: 81.1 88.9
 Zähler: 4 4 5 3 4 0 0 0 0 0
 Innenzehner: 2
 weiteste: 1191 (1), 1187 (11), 1168 (8)
 beste Teiler 60.8 (14.) 185.0 (16.) 210.2 (13.)
 Trefferlage 2.00 mm links, 0.31 mm hoch
 Streuwert 4.90, horizontal: 6.02, vertikal: 3.42

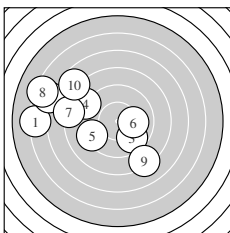
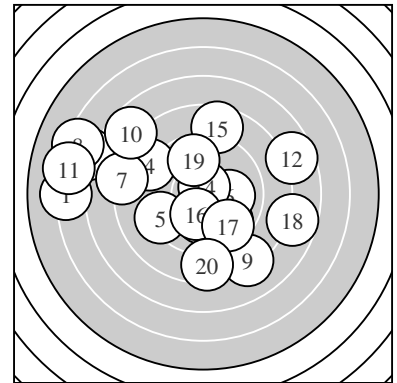

Serie 1:
 6.2 ← 6.8 ↖ 9.7 ↘ 8.8 ↖ 9.3 ↖
 10.0 → 8.1 ← 6.3 ← 8.2 ↘ 7.7 ↖
 beste Teiler 227.4 (6.) 314.4 (3.) 423.4 (5.)
 Trefferlage 4.61 mm links, 0.65 mm hoch
 Streuwert 4.71, horizontal: 5.71, vertikal: 3.42

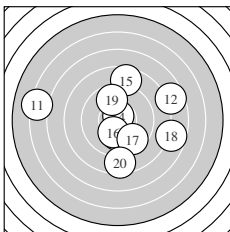

Serie 2:
 6.2 ← 7.6 → 10.1 ↓ 10.7 * 8.6 ↑
 10.2 * 9.6 ↘ 7.7 → 9.7 ↑ 8.5 ↓
 beste Teiler 60.8 (14.) 185.0 (16.) 210.2 (13.)
 Trefferlage 0.60 mm rechts, 0.03 mm tief
 Streuwert 4.56, horizontal: 5.36, vertikal: 3.57

Unterschrift des Schützen

Ergebnis: **180.5** (172)
 Serien: 89.8 90.7
 Zähler: 3 8 7 2 0 0 0 0 0 0
 Innenzehner: 1
 weiteste: 930 (10), 922 (7), 702 (19)
 beste Teiler 151.4 (13.) 236.2 (5.) 243.7 (4.)
 Trefferlage 0.29 mm rechts, 2.25 mm hoch
 Streuwert 3.49, horizontal: 4.04, vertikal: 2.84

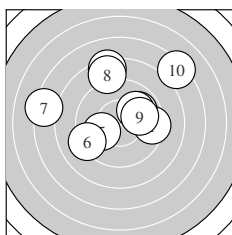
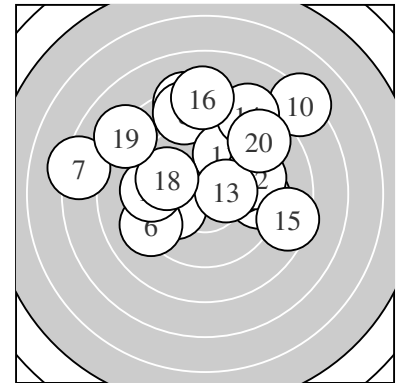

Serie 1:
 9.4 → 9.9 ↗ 8.3 ↑ 10.0 ↗ 10.0 ←
 9.2 ↙ 7.3 ← 8.6 ↑ 9.9 → 7.2 ↗
 beste Teiler 236.2 (5.) 243.7 (4.) 253.6 (9.)
 Trefferlage 0.08 mm links, 2.09 mm hoch
 Streuwert 3.86, horizontal: 4.48, vertikal: 3.11

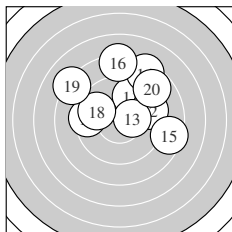

Serie 2:
 9.7 ↗ 9.5 → 10.3 * 8.4 ↗ 8.5 →
 8.2 ↑ 9.4 ← 9.8 ↙ 8.1 ↖ 8.8 ↗
 beste Teiler 151.4 (13.) 293.9 (18.) 317.1 (11.)
 Trefferlage 0.68 mm rechts, 2.41 mm hoch
 Streuwert 3.27, horizontal: 3.75, vertikal: 2.71

Unterschrift des Schützen

Ergebnis: **194.3** (187)
 Serien: 97.6 96.7
 Zähler: 8 11 1 0 0 0 0 0 0 0
 Innenzehner: 4
 weiteste: 561 (20), 499 (7), 491 (13)
 beste Teiler 74.6 (1.) 138.7 (11.) 188.8 (6.)
 Trefferlage 0.90 mm links, 0.29 mm hoch
 Streuwert 2.34, horizontal: 2.82, vertikal: 1.73

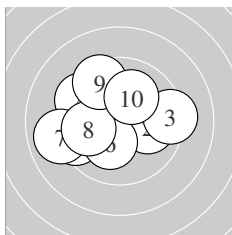
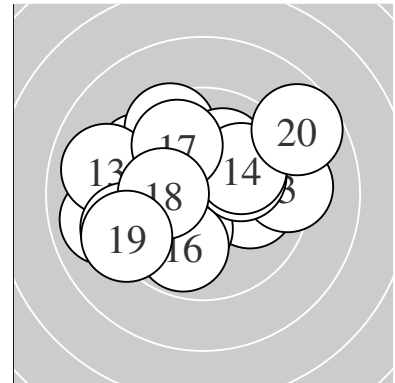

Serie 1:
 10.7 * 10.0 → 9.3 → 9.5 ↖ 9.4 ←
 10.2 * 9.0 ← 9.9 ← 9.5 ↗ 10.1 ↗
 beste Teiler 74.6 (1.) 188.8 (6.) 220.4 (10.)
 Trefferlage 0.87 mm links, 0.25 mm hoch
 Streuwert 2.31, horizontal: 2.83, vertikal: 1.64

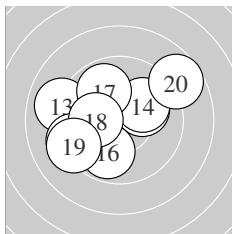

Serie 2:
 10.4 * 10.1 ↗ 9.0 ← 10.0 ↗ 9.3 ←
 9.9 ↘ 9.9 ↘ 10.2 * 9.2 ← 8.7 ↗
 beste Teiler 138.7 (11.) 196.0 (18.) 207.5 (12.)
 Trefferlage 0.93 mm links, 0.32 mm hoch
 Streuwert 2.49, horizontal: 2.96, vertikal: 1.91

Unterschrift des Schützen

Ergebnis: **150.7** (141)
 Serien: 70.4 80.3
 Zähler: 3 3 2 3 4 3 2 0 0 0
 Innenzehner: 2
 weiteste: 1677 (8), 1583 (7), 1488 (2)
 beste Teiler 134.3 (4.) 187.4 (11.) 202.5 (17.)
 Trefferlage 7.40 mm rechts, 1.55 mm tief
 Streuwert 4.44, horizontal: 5.10, vertikal: 3.68

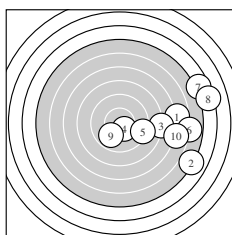
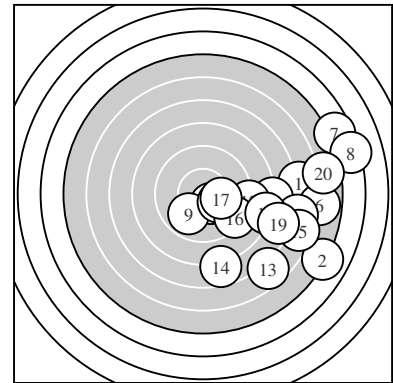

Serie 1:
 6.7 → 5.0 ↘ 7.9 → 10.4 * 9.2 ↘
 5.8 → 4.6 ↗ 4.2 → 9.9 ✓ 6.7 →
 beste Teiler 134.3 (4.) 267.8 (9.) 448.8 (5.)
 Trefferlage 8.81 mm rechts, 0.33 mm tief
 Streuwert 4.99, horizontal: 5.93, vertikal: 3.82

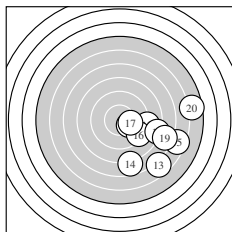

Serie 2:
 10.2 * 8.9 → 6.6 ↘ 7.7 ↓ 6.5 →
 9.2 ↘ 10.1 → 8.1 → 7.4 → 5.6 →
 beste Teiler 187.4 (11.) 202.5 (17.) 430.6 (16.)
 Trefferlage 5.98 mm rechts, 2.77 mm tief
 Streuwert 3.60, horizontal: 3.90, vertikal: 3.27

Unterschrift des Schützen

Ergebnis: **177.8** (169)
 Serien: 91.3 86.5
 Zähler: 5 6 4 4 0 1 0 0 0 0
 Innenzehner: 2
 weiteste: 1262 (11), 905 (16), 865 (7)
 beste Teiler 103.7 (9.) 134.8 (3.) 202.4 (19.)
 Trefferlage 0.28 mm links, 0.11 mm tief
 Streuwert 4.32, horizontal: 4.48, vertikal: 4.15

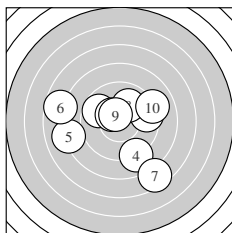
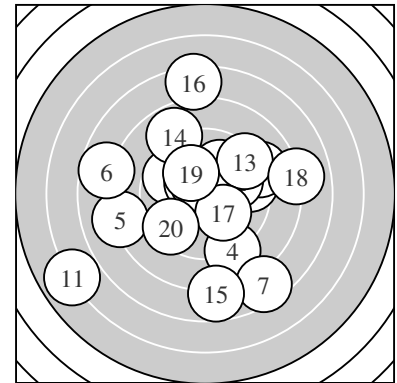

Serie 1:
 9.7 ↘ 9.5 → 10.4 * 8.9 ↘ 8.1 ←
 7.7 ← 7.5 ↘ 10.0 ↗ 10.5 * 9.0 →
 beste Teiler 103.7 (9.) 134.8 (3.) 240.3 (8.)
 Trefferlage 0.29 mm links, 0.39 mm tief
 Streuwert 3.88, horizontal: 4.46, vertikal: 3.19

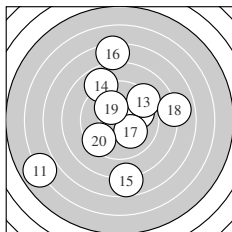

Serie 2:
 5.9 ↙ 9.9 → 9.3 ↗ 8.8 ↖ 7.7 ↓
 7.3 ↑ 10.1 ↘ 8.0 → 10.1 ↖ 9.4 ↙
 beste Teiler 202.4 (19.) 210.0 (17.) 262.0 (12.)
 Trefferlage 0.27 mm links, 0.15 mm hoch
 Streuwert 4.92, horizontal: 4.74, vertikal: 5.10

Unterschrift des Schützen

Ergebnis: **186.2** (179)
 Serien: 92.4 93.8
 Zähler: 5 9 6 0 0 0 0 0 0 0
 Innenzehner: 2
 weiteste: 749 (11), 710 (4), 707 (12)
 beste Teiler 136.0 (20.) 165.8 (9.) 245.2 (16.)
 Trefferlage 0.19 mm links, 0.12 mm hoch
 Streuwert 3.26, horizontal: 3.80, vertikal: 2.59

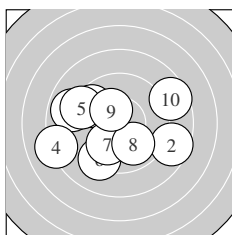
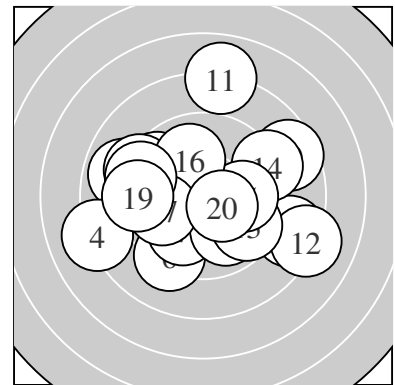

Serie 1:
 9.6 ↘ 8.6 → 8.9 ← 8.1 ← 9.2 ↖
 9.2 ↙ 10.0 ↙ 9.9 ↘ 10.3 * 8.6 →
 beste Teiler 165.8 (9.) 247.9 (7.) 258.2 (8.)
 Trefferlage 1.05 mm links, 0.39 mm tief
 Streuwert 3.32, horizontal: 4.08, vertikal: 2.33

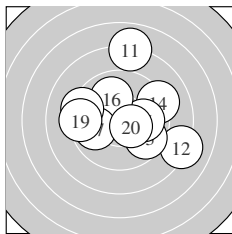

Serie 2:
 8.0 ↑ 8.1 → 9.6 ↘ 9.2 → 10.0 →
 10.0 ↘ 9.9 ← 9.3 ← 9.3 ← 10.4 *
 beste Teiler 136.0 (20.) 245.2 (16.) 248.0 (15.)
 Trefferlage 0.66 mm rechts, 0.65 mm hoch
 Streuwert 3.19, horizontal: 3.50, vertikal: 2.86

Unterschrift des Schützen

Ergebnis: **191.4** (184)
 Serien: 96.6 94.8
 Zähler: 9 6 5 0 0 0 0 0 0 0
 Innenzehner: 2
 weiteste: 748 (14), 706 (18), 578 (7)
 beste Teiler 42.0 (9.) 72.9 (17.) 201.3 (19.)
 Trefferlage 1.28 mm links, 0.21 mm tief
 Streuwert 2.68, horizontal: 3.19, vertikal: 2.05

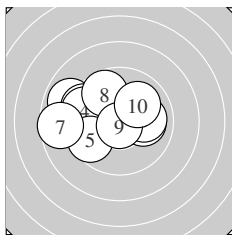
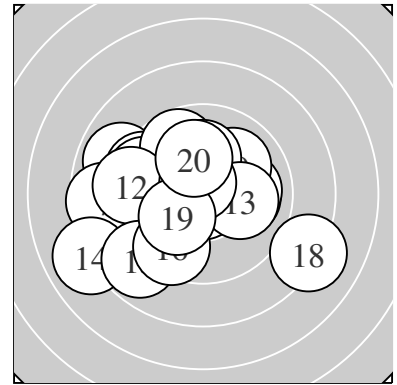

Serie 1:
 8.9 ↖ 9.5 ↖ 10.0 → 9.5 ↖ 9.6 ↖
 10.0 → 8.6 ← 9.7 ↗ 10.8 * 10.0 ↗
 beste Teiler 42.0 (9.) 229.7 (3.) 236.9 (6.)
 Trefferlage 1.53 mm links, 0.61 mm hoch
 Streuwert 2.32, horizontal: 2.99, vertikal: 1.35

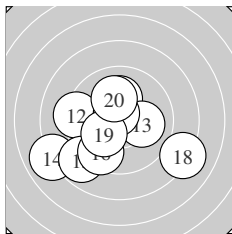

Serie 2:
 10.1 ↑ 9.3 ← 10.1 → 8.0 ↖ 8.8 ↖
 9.5 ↙ 10.7 * 8.1 ↘ 10.1 ↖ 10.1 ↑
 beste Teiler 72.9 (17.) 201.3 (19.) 208.0 (11.)
 Trefferlage 1.03 mm links, 1.03 mm tief
 Streuwert 3.00, horizontal: 3.53, vertikal: 2.35

Unterschrift des Schützen

Ergebnis: **189.3** (181)
 Serien: 89.6 99.7
 Zähler: 7 8 4 1 0 0 0 0 0 0
 Innenzehner: 5
 weiteste: 1000 (7), 687 (5), 621 (4)
 beste Teiler 44.1 (17.) 76.1 (11.) 111.1 (9.)
 Trefferlage 0.45 mm rechts, 0.45 mm hoch
 Streuwert 3.14, horizontal: 3.98, vertikal: 1.96

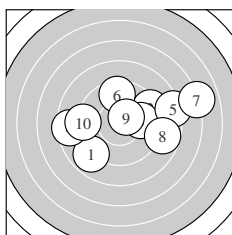
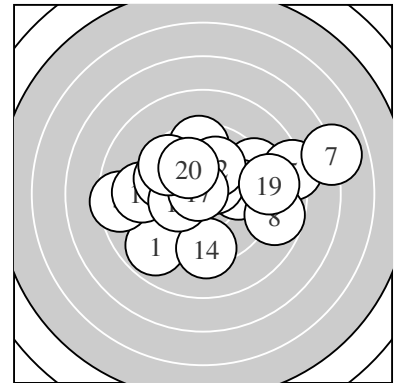

Serie 1:
 8.9 ↙ 9.3 ↗ 9.9 → 8.5 ← 8.2 →
 9.5 ↑ 7.0 → 8.7 → 10.5 * 9.1 ←
 beste Teiler 111.1 (9.) 265.0 (3.) 358.3 (6.)
 Trefferlage 1.42 mm rechts, 0.54 mm hoch
 Streuwert 3.95, horizontal: 5.14, vertikal: 2.19

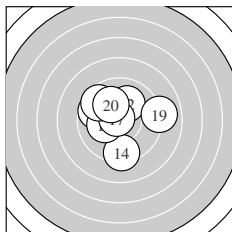

Serie 2:
 10.6 * 10.1 ↗ 10.3 * 9.3 ↓ 9.7 ↖
 10.2 * 10.8 * 9.6 ↘ 9.0 → 10.1 ↘
 beste Teiler 44.1 (17.) 76.1 (11.) 166.0 (13.)
 Trefferlage 0.51 mm links, 0.36 mm hoch
 Streuwert 2.04, horizontal: 2.25, vertikal: 1.81

Unterschrift des Schützen

Ergebnis: **189.6** (179)
 Serien: 93.0 96.6
 Zähler: 6 9 3 2 0 0 0 0 0 0
 Innenzehner: 4
 weiteste: 939 (9), 752 (3), 740 (18)
 beste Teiler 71.0 (11.) 90.6 (12.) 99.4 (13.)
 Trefferlage 0.73 mm rechts, 0.23 mm hoch
 Streuwert 3.10, horizontal: 3.96, vertikal: 1.87

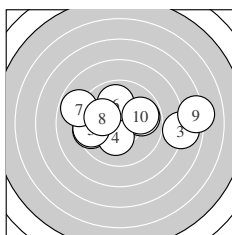
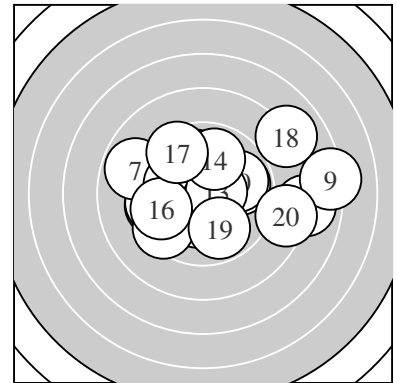

Serie 1:
 9.5 ← 9.8 → 7.9 → 10.3 * 9.5 ←
 10.0 ↑ 8.8 ↖ 10.1 ↖ 7.2 → 9.9 →
 beste Teiler 174.4 (4.) 222.3 (8.) 249.8 (6.)
 Trefferlage 0.70 mm rechts, 0.37 mm hoch
 Streuwert 3.50, horizontal: 4.77, vertikal: 1.32

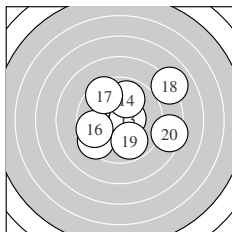

Serie 2:
 10.7 * 10.6 * 10.6 * 9.9 ↑ 9.4 ↙
 9.7 ← 9.5 ↘ 8.0 ↗ 9.8 ↓ 8.4 →
 beste Teiler 71.0 (11.) 90.6 (12.) 99.4 (13.)
 Trefferlage 0.75 mm rechts, 0.10 mm hoch
 Streuwert 2.83, horizontal: 3.22, vertikal: 2.37

Unterschrift des Schützen

Ergebnis: **172.2** (163)
 Serien: 85.2 87.0
 Zähler: 3 7 5 2 1 2 0 0 0 0
 Innenzehner: 2
 weiteste: 1472 (14), 1344 (2), 1034 (5)
 beste Teiler 171.8 (17.) 193.8 (9.) 229.1 (12.)
 Trefferlage 2.08 mm links, 0.65 mm tief
 Streuwert 4.76, horizontal: 6.13, vertikal: 2.79

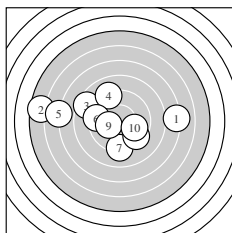
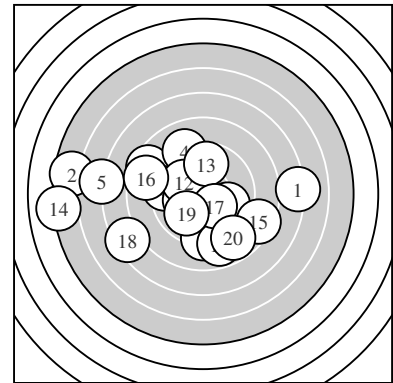

Serie 1:
 7.1 → 5.6 ← 8.5 ↖ 9.1 ↗ 6.8 ←
 9.4 ← 9.2 ↓ 9.4 ↘ 10.2 * 9.9 →
 beste Teiler 193.8 (9.) 273.2 (10.) 377.3 (8.)
 Trefferlage 2.17 mm links, 0.26 mm hoch
 Streuwert 5.02, horizontal: 6.62, vertikal: 2.57

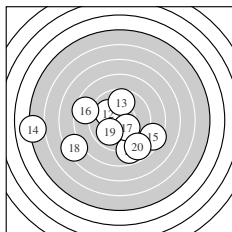

Serie 2:
 8.8 ↓ 10.0 ↖ 9.7 ↑ 5.1 ← 8.4 →
 8.6 ↖ 10.3 * 7.4 ↙ 9.9 ↗ 8.8 ↓
 beste Teiler 171.8 (17.) 229.1 (12.) 258.9 (19.)
 Trefferlage 1.98 mm links, 1.57 mm tief
 Streuwert 4.66, horizontal: 5.95, vertikal: 2.81

Unterschrift des Schützen

Ergebnis: **183.0** (176)
 Serien: 94.0 89.0
 Zähler: 6 6 6 2 0 0 0 0 0 0
 Innenzehner: 1
 weiteste: 804 (18), 757 (7), 726 (1)
 beste Teiler 199.0 (3.) 221.3 (20.) 222.5 (14.)
 Trefferlage 0.76 mm rechts, 0.18 mm tief
 Streuwert 3.54, horizontal: 4.19, vertikal: 2.74

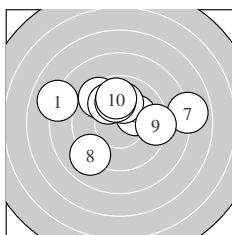
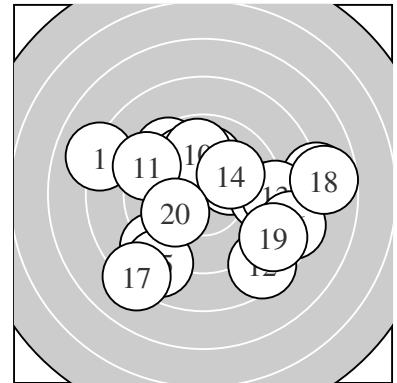

Serie 1:
 8.0 ↖ 9.5 ↘ 10.2 * 10.0 ↗ 10.0 ↑
 10.0 ↑ 7.9 → 9.1 ↙ 9.4 → 9.9 ↑
 beste Teiler 199.0 (3.) 226.2 (5.) 240.6 (6.)
 Trefferlage 0.08 mm links, 1.31 mm hoch
 Streuwert 3.10, horizontal: 3.94, vertikal: 1.93

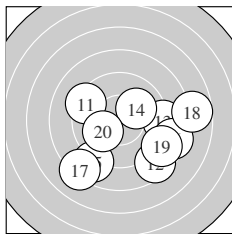

Serie 2:
 9.3 ↖ 8.5 ↘ 9.0 → 10.1 ↗ 8.8 ↙
 8.5 → 8.2 ↙ 7.7 → 8.8 ↘ 10.1 ↖
 beste Teiler 221.3 (20.) 222.5 (14.) 415.0 (11.)
 Trefferlage 1.61 mm rechts, 1.68 mm tief
 Streuwert 3.68, horizontal: 4.47, vertikal: 2.66

Unterschrift des Schützen

Ergebnis: **193.2** (183)
 Serien: 96.0 97.2
 Zähler: 7 10 2 1 0 0 0 0 0 0
 Innenzehner: 4
 weiteste: 769 (17), 717 (3), 527 (16)
 beste Teiler 52.4 (5.) 87.2 (12.) 118.6 (20.)
 Trefferlage 0.57 mm links, 0.49 mm tief
 Streuwert 2.64, horizontal: 3.00, vertikal: 2.24

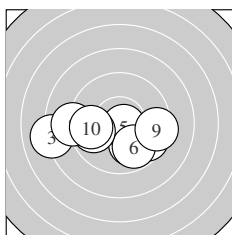
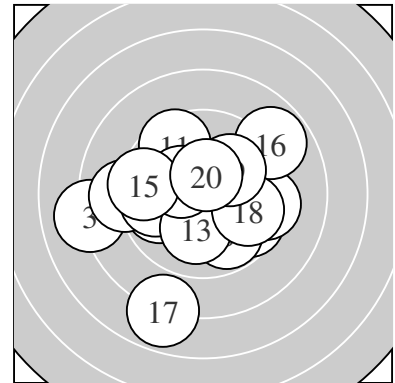

Serie 1:
 10.0 ↘ 9.6 ↘ 8.1 ← 9.8 ← 10.7 *
 9.8 ↘ 9.8 ← 9.0 ← 9.4 → 9.8 ←
 beste Teiler 52.4 (5.) 244.1 (1.) 282.1 (7.)
 Trefferlage 1.06 mm links, 1.05 mm tief
 Streuwert 2.56, horizontal: 3.53, vertikal: 0.82

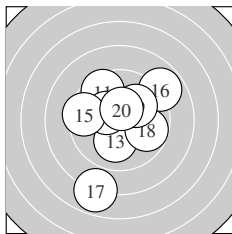

Serie 2:
 9.6 ↖ 10.6 * 10.1 ↓ 10.3 * 9.5 ←
 8.8 ↗ 7.9 ↓ 9.8 → 10.1 ↗ 10.5 *
 beste Teiler 87.2 (12.) 118.6 (20.) 155.3 (14.)
 Trefferlage 0.07 mm links, 0.06 mm hoch
 Streuwert 2.75, horizontal: 2.44, vertikal: 3.03

Unterschrift des Schützen

Ergebnis: **163.8** (153)
 Serien: 76.9 86.9
 Zähler: 2 6 4 4 1 1 2 0 0 0
 Innenzehner: 1
 weiteste: 1537 (4), 1505 (5), 1426 (12)
 beste Teiler 101.0 (20.) 240.3 (8.) 257.5 (11.)
 Trefferlage 0.35 mm links, 0.47 mm hoch
 Streuwert 5.85, horizontal: 5.15, vertikal: 6.48

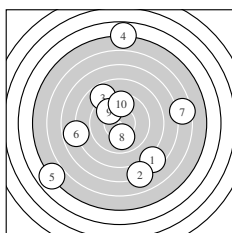
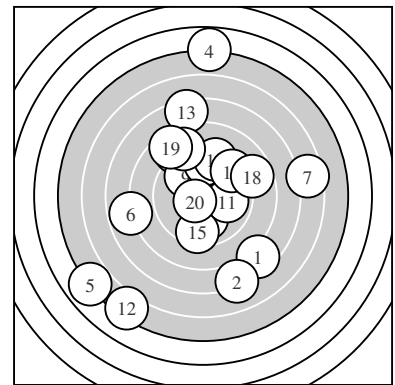

Serie 1:
 7.5 ↘ 7.1 ↓ 8.8 ↖ 4.8 ↑ 4.9 ↙
 7.8 ← 6.5 → 10.0 ↓ 9.9 ↖ 9.6 ↑
 beste Teiler 240.3 (8.) 274.3 (9.) 338.0 (10.)
 Trefferlage 0.25 mm links, 0.13 mm tief
 Streuwert 6.95, horizontal: 6.47, vertikal: 7.40

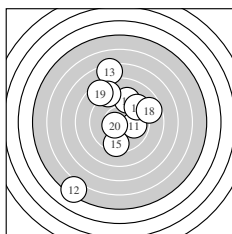

Serie 2:
 9.9 → 5.2 ↙ 7.3 ↑ 9.3 ↑ 9.4 ↓
 9.3 ↗ 8.8 ↖ 8.7 → 8.5 ↖ 10.5 *
 beste Teiler 101.0 (20.) 257.5 (11.) 380.7 (15.)
 Trefferlage 0.46 mm links, 1.08 mm hoch
 Streuwert 4.85, horizontal: 3.75, vertikal: 5.75

Unterschrift des Schützen

Ergebnis: **206.1** (199)
 Serien: 103.1 103.0
 Zähler: 19 1 0 0 0 0 0 0 0 0
 Innenzehner: 14
 weiteste: 255 (16), 250 (5), 232 (7)
 beste Teiler 52.4 (6.) 65.2 (20.) 76.5 (17.)
 Trefferlage 0.52 mm links, 0.32 mm hoch
 Streuwert 1.15, horizontal: 1.27, vertikal: 1.00

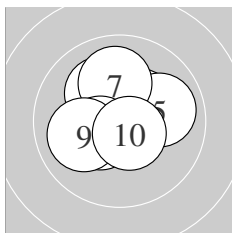
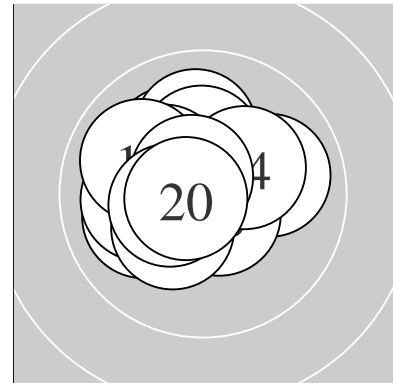

Serie 1:
 10.1 ↖ 10.6 * 10.3 * 10.4 * 10.0 →
 10.7 * 10.0 ↑ 10.4 * 10.0 ← 10.6 *
 beste Teiler 52.4 (6.) 80.9 (2.) 94.6 (10.)
 Trefferlage 0.12 mm links, 0.21 mm hoch
 Streuwert 1.25, horizontal: 1.36, vertikal: 1.13

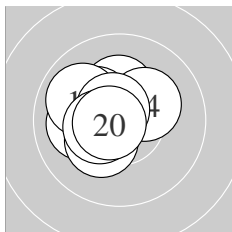

Serie 2:
 10.1 ← 10.3 * 10.3 * 10.2 * 10.2 *
 9.9 ↖ 10.6 * 10.3 * 10.4 * 10.7 *
 beste Teiler 65.2 (20.) 76.5 (17.) 127.7 (19.)
 Trefferlage 0.91 mm links, 0.43 mm hoch
 Streuwert 1.01, horizontal: 1.11, vertikal: 0.90

Unterschrift des Schützen

Ergebnis: **189.1** (181)
 Serien: 90.3 98.8
 Zähler: 7 8 4 1 0 0 0 0 0 0
 Innenzehner: 3
 weiteste: 858 (2), 728 (9), 639 (1)
 beste Teiler 90.2 (16.) 182.1 (12.) 193.2 (3.)
 Trefferlage 0.65 mm rechts, 0.57 mm tief
 Streuwert 3.00, horizontal: 3.76, vertikal: 1.98

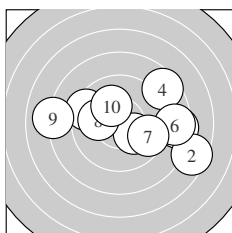
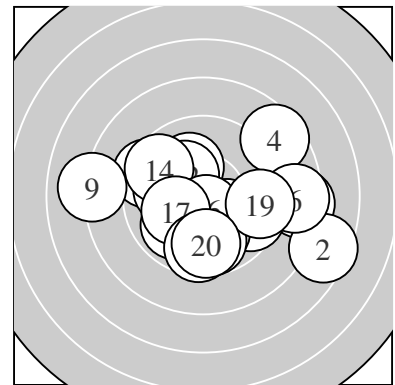

Serie 1:
 8.4 → 7.5 ↘ 10.2 * 8.6 ↗ 9.4 ↖
 8.5 → 9.6 ↘ 10.0 ← 8.0 ← 10.1 ↖
 beste Teiler 193.2 (3.) 208.9 (10.) 233.9 (8.)
 Trefferlage 1.55 mm rechts, 0.14 mm hoch
 Streuwert 3.77, horizontal: 4.96, vertikal: 1.97

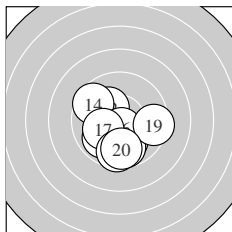

Serie 2:
 10.0 ↓ 10.2 * 9.7 ↓ 9.6 ↖ 9.9 ↗
 10.6 * 10.1 ↖ 9.6 ↓ 9.4 → 9.7 ↓
 beste Teiler 90.2 (16.) 182.1 (12.) 203.5 (17.)
 Trefferlage 0.24 mm links, 1.28 mm tief
 Streuwert 1.83, horizontal: 1.85, vertikal: 1.81

Unterschrift des Schützen

Ergebnis: **181.3** (173)
 Serien: 88.8 92.5
 Zähler: 3 8 8 1 0 0 0 0 0 0
 Innenzehner: 2
 weiteste: 904 (5), 701 (17), 693 (9)
 beste Teiler 78.7 (16.) 87.8 (7.) 232.8 (20.)
 Trefferlage 1.25 mm rechts, 0.15 mm tief
 Streuwert 3.63, horizontal: 4.38, vertikal: 2.68

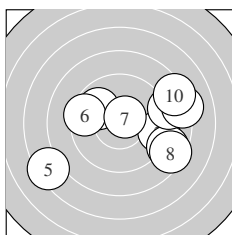
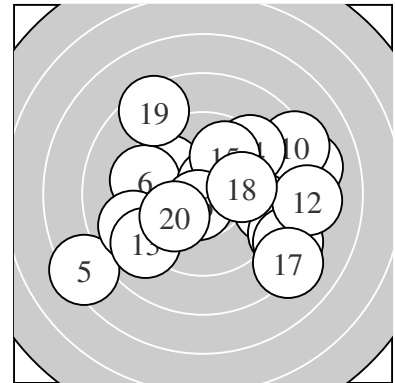

Serie 1:
 9.9 ↘ 9.2 → 8.7 ↘ 8.8 → 7.3 ↙
 9.4 ← 10.6 * 8.4 ↘ 8.2 → 8.3 →
 beste Teiler 87.8 (7.) 274.0 (1.) 383.2 (6.)
 Trefferlage 1.95 mm rechts, 0.19 mm tief
 Streuwert 3.93, horizontal: 4.94, vertikal: 2.55

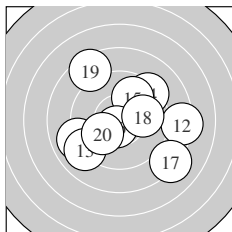

Serie 2:
 9.0 ↙ 8.3 → 9.0 ↙ 9.3 ↗ 9.8 ↗
 10.6 * 8.1 ↘ 9.9 → 8.5 ↘ 10.0 ↙
 beste Teiler 78.7 (16.) 232.8 (20.) 251.8 (18.)
 Trefferlage 0.55 mm rechts, 0.11 mm tief
 Streuwert 3.45, horizontal: 3.88, vertikal: 2.95

Unterschrift des Schützen

Ergebnis: **200.5** (192)
 Serien: 100.0 100.5
 Zähler: 13 6 1 0 0 0 0 0 0 0
 Innenzehner: 9
 weiteste: 589 (10), 373 (6), 345 (2)
 beste Teiler 47.8 (5.) 104.3 (13.) 116.4 (7.)
 Trefferlage 0.00 mm , 0.55 mm hoch
 Streuwert 1.87, horizontal: 2.08, vertikal: 1.63

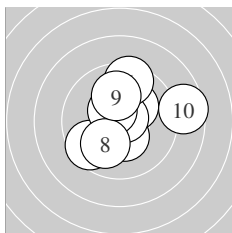
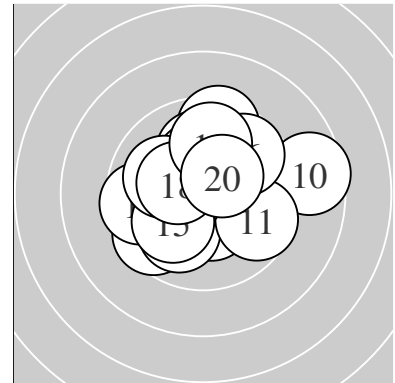

Serie 1:
 10.2 * 9.6 ↙ 10.4 * 10.4 * 10.8 *
 9.5 ↑ 10.5 * 10.0 ↘ 10.0 ↑ 8.6 →
 beste Teiler 47.8 (5.) 116.4 (7.) 140.6 (3.)
 Trefferlage 0.34 mm rechts, 0.54 mm hoch
 Streuwert 2.07, horizontal: 2.23, vertikal: 1.89

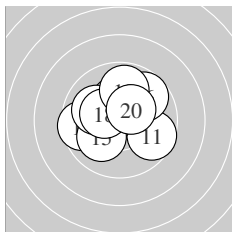

Serie 2:
 9.7 ↘ 9.6 ← 10.5 * 10.3 * 10.1 ↙
 9.7 ↗ 10.0 ↖ 10.4 * 9.8 ↑ 10.4 *
 beste Teiler 104.3 (13.) 142.2 (20.) 150.4 (18.)
 Trefferlage 0.33 mm links, 0.57 mm hoch
 Streuwert 1.72, horizontal: 1.98, vertikal: 1.42

Unterschrift des Schützen

Ergebnis: **198.3** (190)
 Serien: 99.2 99.1
 Zähler: 10 10 0 0 0 0 0 0 0 0
 Innenzehner: 6
 weiteste: 475 (19), 466 (15), 413 (10)
 beste Teiler 108.8 (11.) 125.0 (6.) 129.0 (18.)
 Trefferlage 0.19 mm links, 0.15 mm tief
 Streuwert 2.03, horizontal: 2.27, vertikal: 1.75

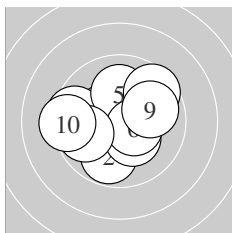
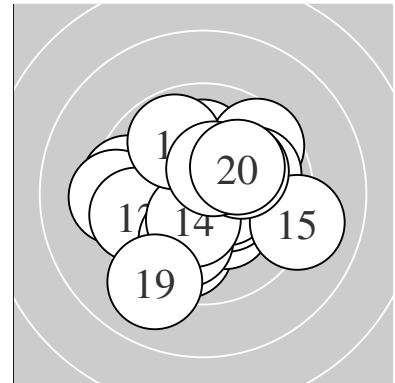

Serie 1:
 10.4 * 9.8 ↘ 10.3 * 9.5 ← 10.1 ↑
 10.5 * 9.8 ← 9.6 ↗ 9.9 → 9.3 ←
 beste Teiler 125.0 (6.) 138.2 (1.) 166.8 (3.)
 Trefferlage 0.53 mm links, 0.09 mm hoch
 Streuwert 2.01, horizontal: 2.38, vertikal: 1.56

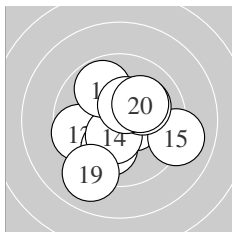

Serie 2:
 10.5 * 9.6 ← 10.0 ↘ 10.4 * 9.1 →
 9.8 ↘ 10.1 → 10.4 * 9.1 ↘ 10.1 ↗
 beste Teiler 108.8 (11.) 129.0 (18.) 130.3 (14.)
 Trefferlage 0.14 mm rechts, 0.41 mm tief
 Streuwert 2.11, horizontal: 2.24, vertikal: 1.97

Unterschrift des Schützen