

Ergebnis: **190.6** (183)
Serien: 96.3 94.3
Zähler: 7 9 4 0 0 0 0 0 0 0
Innenzehner: 4
Weiteste: 724 (12.), 659 (7.), 652 (18.)
beste Teiler: 108.0 (8.), 112.5 (10.), 117.2 (9.)
Trefferlage: 0.01 mm links, 1.04 mm hoch
Streuwert: 2.81, horizontal: 3.09, vertikal: 2.49

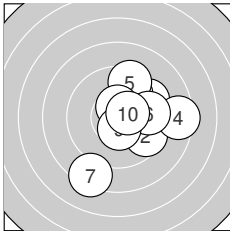
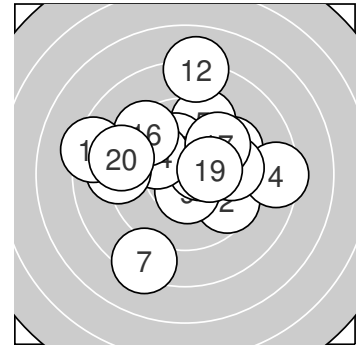

Serie 1:

9.5 ↗	9.6 ↘	9.9 ↗	8.4 →	9.4 ↗
9.7 →	8.3 ↘	10.5 *	10.5 *	10.5 *

beste Teiler: 108.0 (8.), 112.5 (10.), 117.2 (9.)
Trefferlage: 1.65 mm rechts, 0.06 mm hoch
Streuwert: 2.54, horizontal: 2.42, vertikal: 2.65

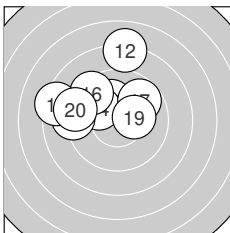

Serie 2:

10.1 ↘	8.1 ↑	10.1 ↖	10.0 ↘	9.1 ←
9.4 ↘	9.7 ↗	8.3 ←	10.3 *	9.2 ←

beste Teiler: 172.9 (19.), 206.1 (13.), 208.1 (11.)
Trefferlage: 1.68 mm links, 2.03 mm hoch
Streuwert: 2.45, horizontal: 2.84, vertikal: 1.98



Ergebnis: **179.3** (169)
Serien: 92.2 87.1
Zähler: 3 7 7 2 1 0 0 0 0 0
Innenzehner: 2
Weiteste: 1016 (5.), 918 (12.), 798 (20.)
beste Teiler: 63.8 (7.), 102.0 (17.), 235.5 (2.)
Trefferlage: 2.12 mm rechts, 0.64 mm hoch
Streuwert: 3.68, horizontal: 4.46, vertikal: 2.69

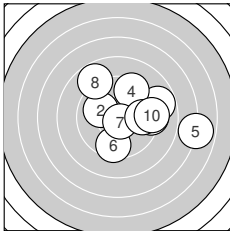
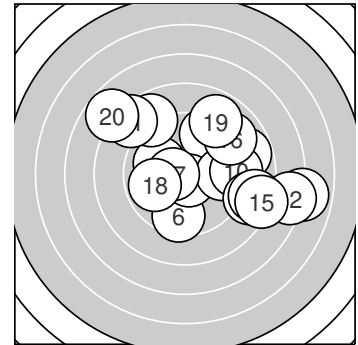

Serie 1:

8.8 →	10.0 ↖	9.2 →	9.4 ↗	6.9 →
9.5 ↓	10.7 *	8.8 ↘	9.7 →	9.2 →

beste Teiler: 63.8 (7.), 235.5 (2.), 317.0 (9.)
Trefferlage: 2.34 mm rechts, 0.50 mm hoch
Streuwert: 3.21, horizontal: 3.88, vertikal: 2.36

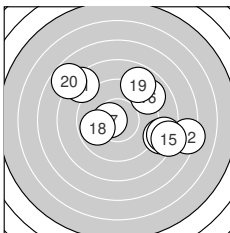

Serie 2:

8.4 ↖	7.3 →	8.6 →	8.5 →	8.2 →
9.0 ↗	10.5 *	9.9 ←	8.9 ↗	7.8 ↖

beste Teiler: 102.0 (17.), 273.3 (18.), 491.5 (16.)
Trefferlage: 1.90 mm rechts, 0.77 mm hoch
Streuwert: 4.28, horizontal: 5.18, vertikal: 3.12



Ergebnis: **190.1** (179)
 Serien: 94.8 95.3
 Zähler: 5 11 2 2 0 0 0 0 0 0
 Innenzehner: 5
 Weitestе: 908 (2.), 754 (19.), 655 (20.)
 beste Teiler: 79.1 (12.), 97.9 (11.), 121.6 (8.)
 Trefferlage: 0.10 mm links, 0.70 mm hoch
 Streuwert: 3.00, horizontal: 3.32, vertikal: 2.63

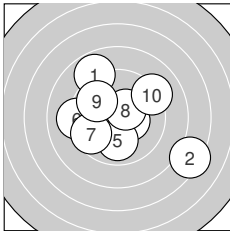
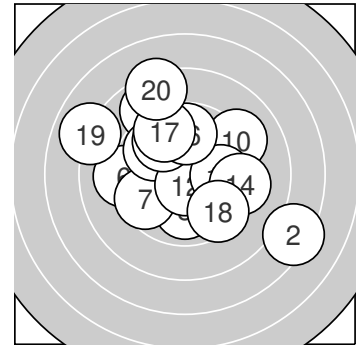

Serie 1:

8.8 ↘	7.3 ↘	10.4 *	10.2 *	9.9 ↓
9.2 ←	9.6 ↙	10.5 *	9.8 ↘	9.1 ↗

beste Teiler: 121.6 (8.), 135.5 (3.), 182.0 (4.)
 Trefferlage: 0.00 mm , 0.05 mm hoch
 Streuwert: 3.19, horizontal: 3.69, vertikal: 2.60

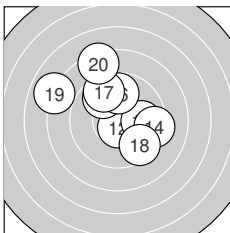

Serie 2:

10.6 *	10.6 *	9.9 →	9.3 →	9.8 ↘
9.8 ↑	9.6 ↘	9.5 ↘	7.9 ↙	8.3 ↗

beste Teiler: 79.1 (12.), 97.9 (11.), 262.1 (13.)
 Trefferlage: 0.19 mm links, 1.35 mm hoch
 Streuwert: 2.88, horizontal: 3.11, vertikal: 2.62



Ergebnis: **193.2** (183)
 Serien: 95.7 97.5
 Zähler: 8 8 3 1 0 0 0 0 0 0
 Innenzehner: 6
 Weitester: 834 (3.), 600 (11.), 565 (14.)
 beste Teiler: 99.0 (12.), 117.3 (20.), 117.7 (15.)
 Trefferlage: 0.13 mm links, 0.14 mm tief
 Streuwert: 2.71, horizontal: 3.25, vertikal: 2.03

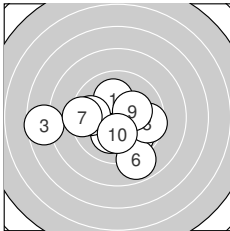
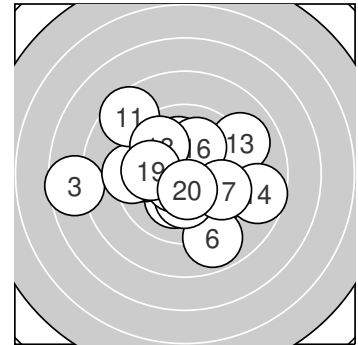

Serie 1:

10.1 ↑	10.2 *	7.6 ←	9.7 ←	9.8 ↘
8.9 ↘	9.4 ←	9.6 →	10.2 *	10.2 *

beste Teiler: 181.4 (9.), 183.0 (10.), 199.2 (2.)
 Trefferlage: 0.77 mm links, 0.90 mm tief
 Streuwert: 2.82, horizontal: 3.51, vertikal: 1.88

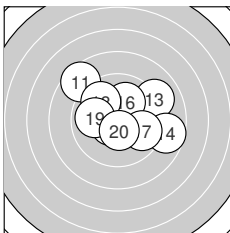

Serie 2:

8.6 ↘	10.6 *	9.0 ↗	8.7 →	10.5 *
10.1 ↗	9.8 →	9.8 ↘	9.9 ←	10.5 *

beste Teiler: 99.0 (12.), 117.3 (20.), 117.7 (15.)
 Trefferlage: 0.50 mm rechts, 0.61 mm hoch
 Streuwert: 2.55, horizontal: 3.02, vertikal: 1.96



Ergebnis: **185.4** (176)
 Serien: 93.8 91.6
 Zähler: 7 7 4 0 1 1 0 0 0 0
 Innenzehner: 5
 Weitestе: 1464 (10.), 1119 (14.), 625 (8.)
 beste Teiler: 89.5 (6.), 140.2 (17.), 174.4 (1.)
 Trefferlage: 1.57 mm rechts, 0.56 mm hoch
 Streuwert: 3.72, horizontal: 4.80, vertikal: 2.15

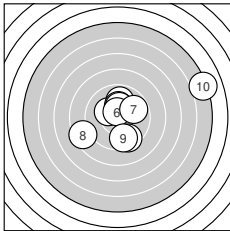
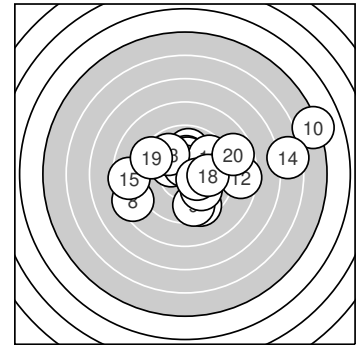

Serie 1:

10.3 *	9.9 ↑	10.2 *	9.5 ↓	10.3 *
10.6 *	9.8 ↗	8.5 ↖	9.6 ↓	5.1 →

beste Teiler: 89.5 (6.), 174.4 (1.), 174.9 (5.)
 Trefferlage: 1.25 mm rechts, 0.48 mm hoch
 Streuwert: 3.99, horizontal: 4.92, vertikal: 2.78

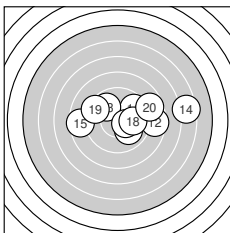

Serie 2:

9.7 ↗	8.6 →	9.9 ↘	6.5 →	8.5 ←
10.0 ↘	10.4 *	10.0 →	9.3 ↖	8.7 →

beste Teiler: 140.2 (17.), 241.2 (16.), 247.3 (18.)
 Trefferlage: 1.89 mm rechts, 0.65 mm hoch
 Streuwert: 3.62, horizontal: 4.93, vertikal: 1.41



Ergebnis: **189.6** (180)
 Serien: 97.0 92.6
 Zähler: 3 14 3 0 0 0 0 0 0 0
 Innenzehner: 1
 Weitestе: 626 (11.), 546 (20.), 505 (18.)
 beste Teiler: 190.2 (10.), 203.3 (6.), 234.0 (13.)
 Trefferlage: 0.28 mm rechts, 0.18 mm tief
 Streuwert: 2.79, horizontal: 3.41, vertikal: 1.97

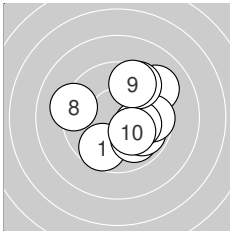
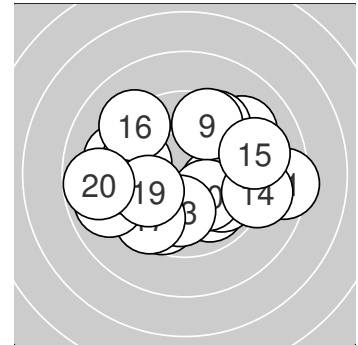

Serie 1:

9.7 ↙	9.9 ↘	9.2 ↗	9.9 ↘	9.7 →
10.1 →	9.5 ↗	9.2 ←	9.6 ↗	10.2 *

beste Teiler: 190.2 (10.), 203.3 (6.), 256.6 (2.)
 Trefferlage: 1.16 mm rechts, 0.14 mm hoch
 Streuwert: 2.25, horizontal: 2.30, vertikal: 2.20

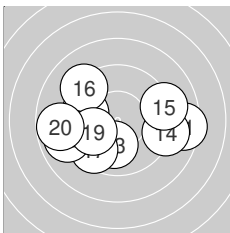

Serie 2:

8.4 →	9.7 ←	10.0 ↓	9.1 →	9.1 →
9.2 ↘	9.5 ↙	8.9 ←	9.9 ←	8.8 ←

beste Teiler: 234.0 (13.), 253.6 (19.), 315.8 (12.)
 Trefferlage: 0.60 mm links, 0.51 mm tief
 Streuwert: 3.21, horizontal: 4.18, vertikal: 1.77



Ergebnis: **188.7** (179)
Serien: 94.8 93.9
Zähler: 6 9 4 0 1 0 0 0 0 0
Innenzehner: 4
Weiteste: 1038 (13.), 560 (4.), 560 (7.)
beste Teiler: 9.8 (8.), 89.8 (12.), 153.2 (17.)
Trefferlage: 0.76 mm rechts, 1.29 mm hoch
Streuwert: 2.99, horizontal: 3.80, vertikal: 1.88

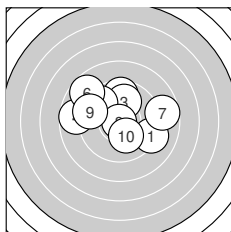
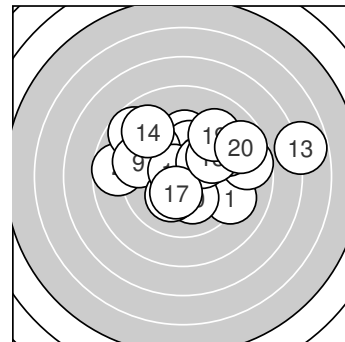

Serie 1:

9.2 ↘	9.6 ↑	9.9 ↑	8.7 ←	9.6 ↘
8.7 ↘	8.7 →	10.9 *	9.4 ↖	10.1 ↓

beste Teiler: 9.8 (8.), 201.4 (10.), 258.3 (3.)
Trefferlage: 0.50 mm links, 1.11 mm hoch
Streuwert: 2.88, horizontal: 3.57, vertikal: 1.96

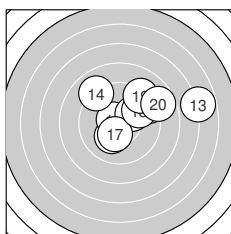

Serie 2:

10.2 *	10.6 *	6.8 →	9.0 ↘	10.1 ↗
9.2 ↗	10.3 *	9.8 ↗	9.2 ↗	8.7 ↗

beste Teiler: 89.8 (12.), 153.2 (17.), 194.3 (11.)
Trefferlage: 2.03 mm rechts, 1.47 mm hoch
Streuwert: 2.97, horizontal: 3.76, vertikal: 1.87



Ergebnis: **174.5** (163)
 Serien: 86.1 88.4
 Zähler: 1 8 7 1 3 0 0 0 0 0
 Innenzehner: 1
 Weitester: 1247 (18.), 1142 (5.), 1046 (11.)
 beste Teiler: 22.0 (3.), 267.7 (13.), 269.2 (16.)
 Trefferlage: 0.76 mm rechts, 0.51 mm hoch
 Streuwert: 4.57, horizontal: 4.93, vertikal: 4.19

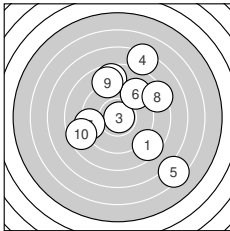
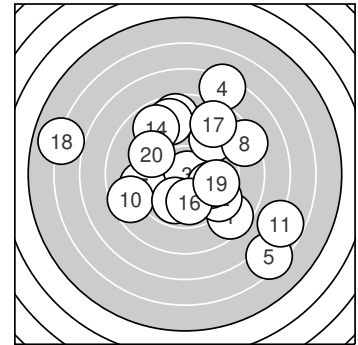

Serie 1:

8.6 ↘	8.7 ↑	10.9 *	7.3 ↗	6.4 ↘
9.2 ↗	9.3 ←	8.3 ↘	8.8 ↑	8.6 ←

beste Teiler: 22.0 (3.), 423.4 (7.), 432.8 (6.)
 Trefferlage: 1.30 mm rechts, 1.00 mm hoch
 Streuwert: 4.70, horizontal: 4.36, vertikal: 5.01

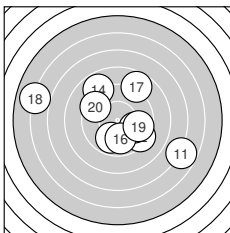

Serie 2:

6.8 ↘	9.3 ↘	9.9 ↘	8.8 ↖	9.9 ↓
9.9 ↓	8.7 ↗	6.0 ←	9.7 →	9.4 ↖

beste Teiler: 267.7 (13.), 269.2 (16.), 273.7 (15.)
 Trefferlage: 0.21 mm rechts, 0.01 mm hoch
 Streuwert: 4.63, horizontal: 5.62, vertikal: 3.37



Ergebnis: **187.3** (180)
Serien: 94.6 92.7
Zähler: 7 7 5 1 0 0 0 0 0 0
Innenzehner: 5
Weiteste: 828 (13.), 712 (15.), 705 (5.)
beste Teiler: 90.5 (8.), 104.0 (16.), 109.1 (6.)
Trefferlage: 0.69 mm rechts, 0.50 mm tief
Streuwert: 3.21, horizontal: 3.71, vertikal: 2.62

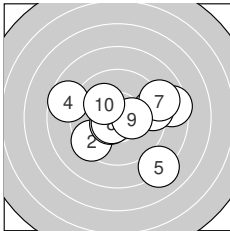
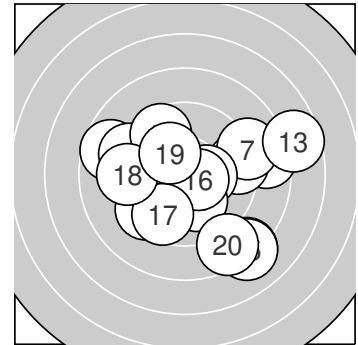

Serie 1:
 8.5 → 9.4 ↙ 9.4 → 8.7 ← 8.1 ↘
 10.5 * 9.0 → 10.6 * 10.3 * 10.1 ↖
beste Teiler: 90.5 (8.), 109.1 (6.), 156.4 (9.)
Trefferlage: 0.92 mm rechts, 0.24 mm tief
Streuwert: 3.10, horizontal: 3.75, vertikal: 2.28

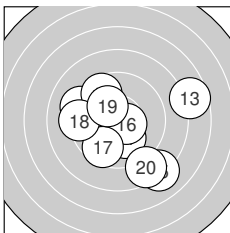

Serie 2:
 10.1 ↘ 9.2 ↖ 7.6 → 9.6 ↗ 8.1 ↘
 10.5 * 9.6 ↙ 9.3 ← 10.2 * 8.5 ↘
beste Teiler: 104.0 (16.), 188.4 (19.), 212.2 (11.)
Trefferlage: 0.46 mm rechts, 0.76 mm tief
Streuwert: 3.46, horizontal: 3.85, vertikal: 3.02



Ergebnis: **188.5** (181)
Serien: 92.8 95.7
Zähler: 3 15 2 0 0 0 0 0 0 0
Innenzehner: 2
Weiteste: 659 (14.), 578 (2.), 494 (8.)
beste Teiler: 78.9 (11.), 188.6 (7.), 234.9 (18.)
Trefferlage: 0.63 mm rechts, 0.06 mm hoch
Streuwert: 2.88, horizontal: 3.32, vertikal: 2.34

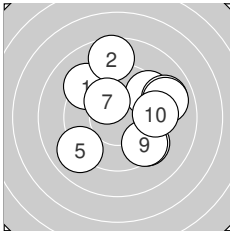
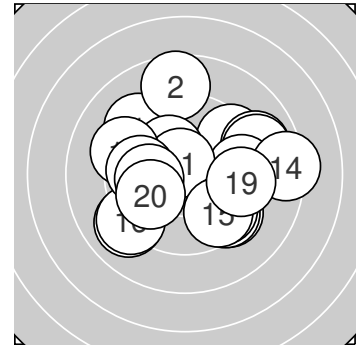

Serie 1:

9.2 ↘	8.6 ↑	9.4 ↗	9.4 ↘	9.0 ↙
9.0 →	10.2 *	9.0 →	9.5 ↘	9.5 →

beste Teiler: 188.6 (7.), 365.6 (9.), 370.3 (10.)
Trefferlage: 1.30 mm rechts, 0.82 mm hoch
Streuwert: 2.97, horizontal: 3.11, vertikal: 2.83

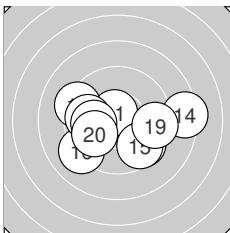

Serie 2:

10.6 *	9.6 ↘	9.3 ↖	8.3 →	9.6 ↘
9.1 ↙	9.8 ←	10.0 ←	9.5 →	9.9 ↙

beste Teiler: 78.9 (11.), 234.9 (18.), 260.0 (20.)
Trefferlage: 0.03 mm links, 0.69 mm tief
Streuwert: 2.74, horizontal: 3.56, vertikal: 1.52



LG 20 ZR – Wertung –
StandNr: 111
Haim, Andreas #70817785

Jugend_II_männl.

StartNr: 11
28. Oktober 2021 20:29
ST–SV Kainisch / Steiermark 2

Ergebnis: **0.0** (0)_{DNS}
Serien:
Zähler: 0 0 0 0 0 0 0 0 0 0
Innenzehner: 0
Weiteste:
~~beste Teiler~~
Trefferlage: 0.00 mm , 0.00 mm
Streuwert:

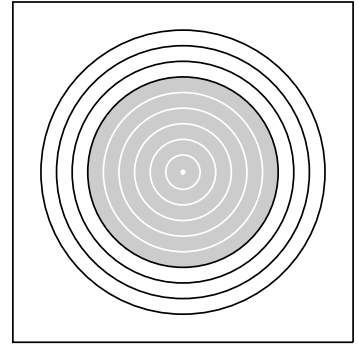

Ergebnis: **189.1** (181)
 Serien: 94.4 94.7
 Zähler: 6 11 1 2 0 0 0 0 0 0
 Innenzehner: 4
 Weitester: 978 (20.), 751 (5.), 544 (10.)
 beste Teiler: 54.3 (4.), 102.2 (13.), 128.6 (8.)
 Trefferlage: 1.33 mm links, 0.16 mm hoch
 Streuwert: 2.96, horizontal: 3.16, vertikal: 2.74

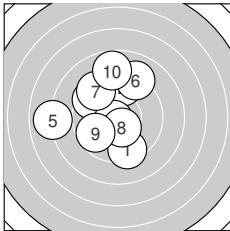
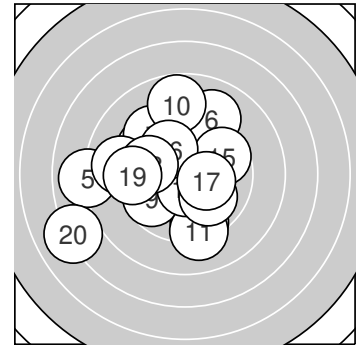

Serie 1:

9.4 ↓ 9.5 ↑ 9.5 ↘
 9.1 ↗ 9.4 ↖ 10.4 *

10.7 * 7.9 ←
 9.7 ↙ 8.8 ↑

beste Teiler: 54.3 (4.), 128.6 (8.), 312.3 (9.)
 Trefferlage: 1.24 mm links, 1.10 mm hoch
 Streuwert: 2.88, horizontal: 2.78, vertikal: 2.98

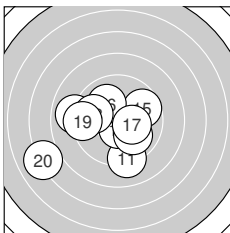

Serie 2:

9.1 ↓ 9.0 ← 10.5 *
 10.0 ↘ 10.3 * 9.8 ←

10.0 ↘ 9.7 →
 9.3 ← 7.0 ↙

beste Teiler: 102.2 (13.), 173.0 (17.), 227.9 (16.)
 Trefferlage: 1.42 mm links, 0.77 mm tief
 Streuwert: 3.03, horizontal: 3.65, vertikal: 2.25



Ergebnis: **183.3** (175)
 Serien: 90.2 93.1
 Zähler: 5 10 3 0 1 1 0 0 0 0
 Innenzehner: 1
 Weitester: 1421 (4.), 1127 (18.), 708 (5.)
 beste Teiler: 114.5 (13.), 203.2 (8.), 220.1 (14.)
 Trefferlage: 3.44 mm links, 0.90 mm hoch
 Streuwert: 3.02, horizontal: 3.71, vertikal: 2.11

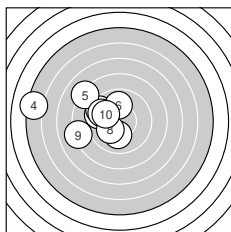
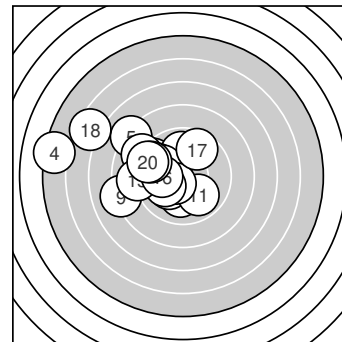

Serie 1:

9.5 ↖	9.5 ↖	10.1 ↓	5.3 ↖	8.1 ↖
9.9 ↑	9.7 ↖	10.1 ↙	8.1 ↖	9.9 ↖

beste Teiler: 203.2 (8.), 222.6 (3.), 252.2 (10.)
 Trefferlage: 4.02 mm links, 0.91 mm hoch
 Streuwert: 3.27, horizontal: 4.08, vertikal: 2.18

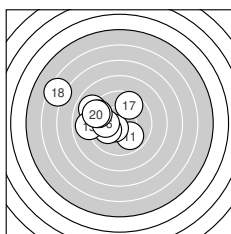

Serie 2:

9.9 ↘	8.9 ↖	10.5 *	10.1 ↖	9.0 ←
10.0 ←	9.6 ↗	6.4 ↖	9.4 ↖	9.3 ↖

beste Teiler: 114.5 (13.), 220.1 (14.), 227.0 (16.)
 Trefferlage: 2.86 mm links, 0.90 mm hoch
 Streuwert: 2.86, horizontal: 3.42, vertikal: 2.17



Ergebnis: **191.6** (183)
Serien: 96.3 95.3
Zähler: 9 7 2 2 0 0 0 0 0 0
Innenzehner: 6
Weiteste: 833 (2.), 754 (16.), 636 (10.)
beste Teiler: 41.7 (9.), 99.5 (7.), 101.5 (5.)
Trefferlage: 0.44 mm rechts, 1.30 mm hoch
Streuwert: 2.75, horizontal: 2.74, vertikal: 2.76

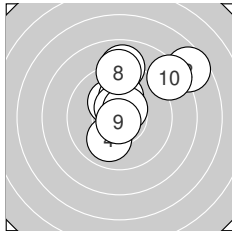
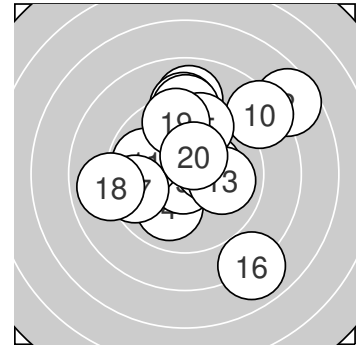

Serie 1:

10.2 *	7.6 ↗	10.1 ↑	10.0 ✓	10.5 *
9.0 ↑	10.6 *	9.1 ↑	10.8 *	8.4 ↗

beste Teiler: 41.7 (9.), 99.5 (7.), 101.5 (5.)
Trefferlage: 1.02 mm rechts, 2.10 mm hoch
Streuwert: 2.54, horizontal: 2.65, vertikal: 2.42

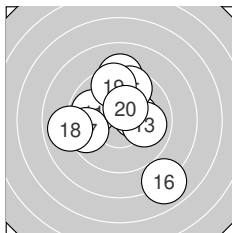

Serie 2:

9.9 ←	10.3 *	10.0 →	9.2 ↑	9.6 ↑
7.9 ↘	9.6 ←	8.9 ←	9.5 ↑	10.4 *

beste Teiler: 135.5 (20.), 161.4 (12.), 249.5 (13.)
Trefferlage: 0.14 mm links, 0.51 mm hoch
Streuwert: 2.91, horizontal: 2.83, vertikal: 2.98



Ergebnis: **199.9** (191)
Serien: 100.9 99.0
Zähler: 11 9 0 0 0 0 0 0 0 0
Innenzehner: 8
Weiteste: 393 (17.), 348 (1.), 336 (13.)
beste Teiler: 84.1 (6.), 120.1 (9.), 129.8 (5.)
Trefferlage: 0.00 mm , 0.29 mm tief
Streuwert: 1.84, horizontal: 1.64, vertikal: 2.02

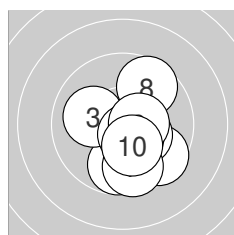
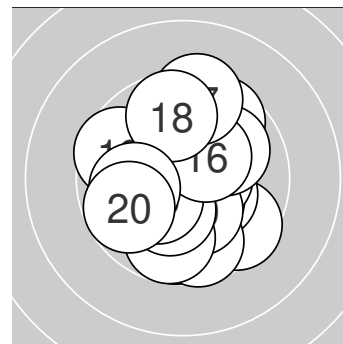

Serie 1:

9.6 ↘	9.8 ↓	10.1 ←	10.3 *	10.4 *
10.6 *	9.7 ↓	9.6 ↗	10.5 *	10.3 *

beste Teiler: 84.1 (6.), 120.1 (9.), 129.8 (5.)
Trefferlage: 0.72 mm rechts, 0.91 mm tief
Streuwert: 1.55, horizontal: 1.29, vertikal: 1.76

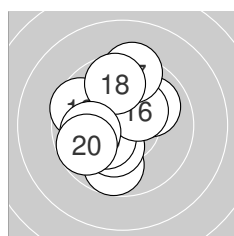

Serie 2:

9.7 ↓	10.0 ↗	9.6 ↖	10.3 *	10.3 *
10.3 *	9.4 ↑	9.7 ↑	10.0 ←	9.7 ↙

beste Teiler: 155.6 (16.), 158.6 (15.), 169.1 (14.)
Trefferlage: 0.73 mm links, 0.32 mm hoch
Streuwert: 1.94, horizontal: 1.68, vertikal: 2.17



Ergebnis: **192.7** (184)
 Serien: 94.3 98.4
 Zähler: 5 14 1 0 0 0 0 0 0 0
 Innenzehner: 3
 Weitestе: 708 (1.), 473 (3.), 444 (15.)
 beste Teiler: 128.1 (13.), 147.0 (11.), 147.7 (4.)
 Trefferlage: 0.34 mm links, 0.87 mm hoch
 Streuwert: 2.50, horizontal: 2.73, vertikal: 2.25

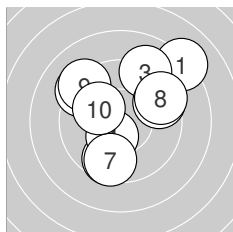
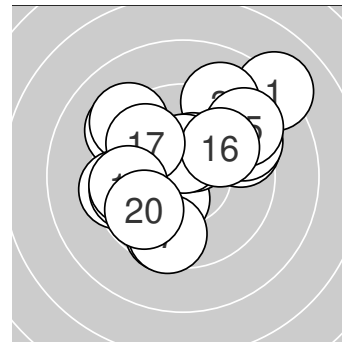

Serie 1:

8.1 ↗	9.6 ↓	9.1 ↑	10.4 *	9.3 ↘
9.5 ↗	9.6 ↓	9.4 ↗	9.2 ↘	10.1 ↘

beste Teiler: 147.7 (4.), 216.0 (10.), 336.1 (2.)
 Trefferlage: 0.30 mm rechts, 1.16 mm hoch
 Streuwert: 2.92, horizontal: 2.98, vertikal: 2.87

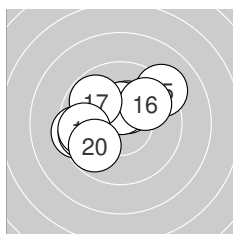

Serie 2:

10.4 *	10.1 ↘	10.4 *	9.4 ←	9.2 ↗
9.9 ↗	9.8 ↘	9.7 ←	9.7 ←	9.8 ↗

beste Teiler: 128.1 (13.), 147.0 (11.), 217.4 (12.)
 Trefferlage: 1.00 mm links, 0.58 mm hoch
 Streuwert: 2.01, horizontal: 2.43, vertikal: 1.49



Ergebnis: **190.3** (182)
Serien: 95.9 94.4
Zähler: 8 8 2 2 0 0 0 0 0 0
Innenzehner: 4
Weiteste: 826 (19.), 757 (20.), 567 (9.)
beste Teiler: 63.6 (17.), 129.7 (7.), 176.1 (5.)
Trefferlage: 0.82 mm links, 0.27 mm hoch
Streuwert: 2.88, horizontal: 3.58, vertikal: 1.95

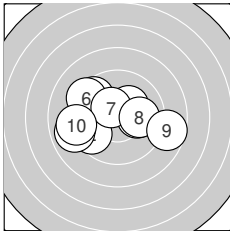
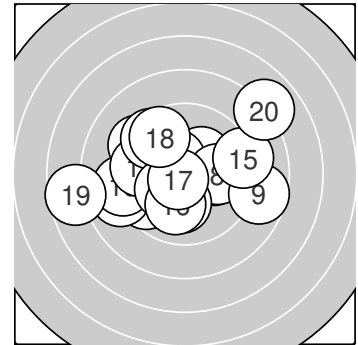

Serie 1:

9.6 ↘ 9.6 ↙ 8.9 ←
 9.3 ↘ 10.4 * 10.0 →

10.1 → 10.2 *
 8.7 → 9.1 ←

beste Teiler: 129.7 (7.), 176.1 (5.), 216.1 (4.)
Trefferlage: 0.77 mm links, 0.08 mm hoch
Streuwert: 2.68, horizontal: 3.46, vertikal: 1.54

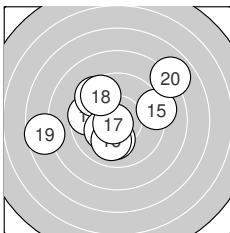

Serie 2:

9.6 ← 9.5 ↘ 10.1 ↓ 10.2 * 9.2 →
 10.0 ↓ 10.7 * 9.6 ↘ 7.6 ← 7.9 ↗

10.2 * 9.2 →
 7.6 ← 7.9 ↗

beste Teiler: 63.6 (17.), 185.8 (14.), 215.9 (13.)
Trefferlage: 0.86 mm links, 0.45 mm hoch
Streuwert: 3.21, horizontal: 3.88, vertikal: 2.37



Ergebnis: **190.0** (183)
 Serien: 94.4 95.6
 Zähler: 5 13 2 0 0 0 0 0 0 0
 Innenzehner: 2
 Weitesten: 675 (8.), 552 (6.), 488 (18.)
 beste Teiler: 163.2 (9.), 190.0 (3.), 209.2 (20.)
 Trefferlage: 0.35 mm rechts, 0.32 mm tief
 Streuwert: 2.75, horizontal: 2.93, vertikal: 2.56

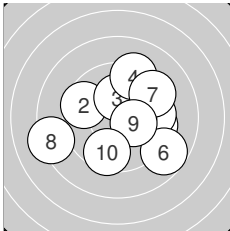
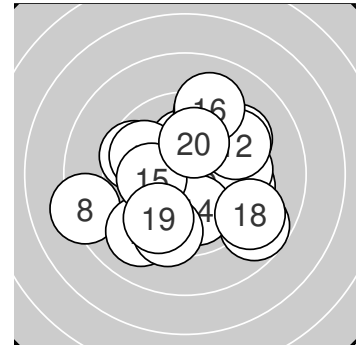

Serie 1:

9.5 →	9.6 ↖	10.2 *	9.3 ↗	9.6 →
8.7 ↘	9.3 ↗	8.3 ←	10.3 *	9.6 ↓

beste Teiler: 163.2 (9.), 190.0 (3.), 338.2 (5.)
 Trefferlage: 0.70 mm rechts, 0.06 mm tief
 Streuwert: 2.98, horizontal: 3.44, vertikal: 2.43

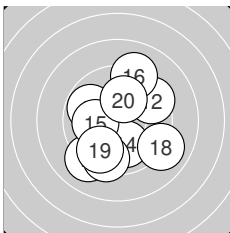

Serie 2:

9.8 ↖	9.4 ↗	9.1 ↙	10.0 ↓	10.1 ←
9.1 ↗	9.4 ↓	9.0 ↘	9.6 ↙	10.1 ↗

beste Teiler: 209.2 (20.), 214.7 (15.), 242.5 (14.)
 Trefferlage: 0.00 mm , 0.59 mm tief
 Streuwert: 2.63, horizontal: 2.46, vertikal: 2.79



Ergebnis: **202.1** (191)
Serien: 99.4 102.7
Zähler: 13 5 2 0 0 0 0 0 0 0
Innenzehner: 11
Weiteste: 601 (15.), 546 (1.), 316 (5.)
beste Teiler: 32.0 (19.), 49.3 (13.), 55.4 (12.)
Trefferlage: 0.66 mm links, 0.82 mm hoch
Streuwert: 1.70, horizontal: 2.00, vertikal: 1.32

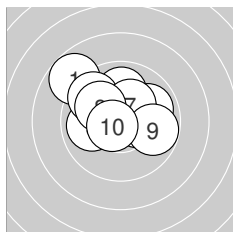
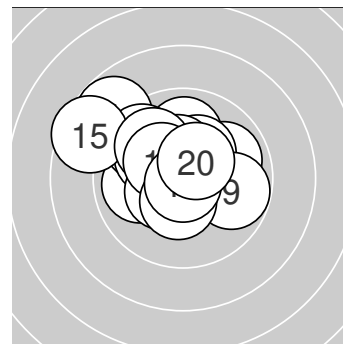

Serie 1:

8.8 ↘ 9.9 → 9.9 ← 10.0 ↑ 9.7 ↖
 10.3 * 10.3 * 10.1 ↖ 9.8 → 10.6 *
beste Teiler: 83.2 (10.), 153.2 (6.), 167.7 (7.)
Trefferlage: 0.37 mm links, 1.04 mm hoch
Streuwert: 1.92, horizontal: 2.29, vertikal: 1.45

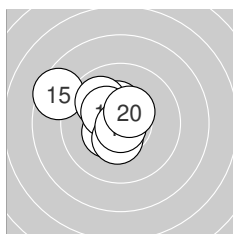

Serie 2:

10.4 * 10.7 * 10.8 * 10.4 * 8.5 ↖
 9.9 ↘ 10.3 * 10.4 * 10.8 * 10.5 *
beste Teiler: 32.0 (19.), 49.3 (13.), 55.4 (12.)
Trefferlage: 0.96 mm links, 0.61 mm hoch
Streuwert: 1.50, horizontal: 1.74, vertikal: 1.21



Ergebnis: **182.5** (175)
 Serien: 89.7 92.8
 Zähler: 5 7 7 0 1 0 0 0 0 0
 Innenzehner: 3
 Weitester: 1162 (5.), 681 (14.), 667 (11.)
 beste Teiler: 122.4 (15.), 138.7 (19.), 199.4 (12.)
 Trefferlage: 0.99 mm links, 0.70 mm hoch
 Streuwert: 3.63, horizontal: 4.17, vertikal: 3.00

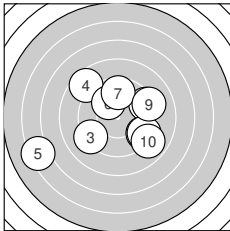
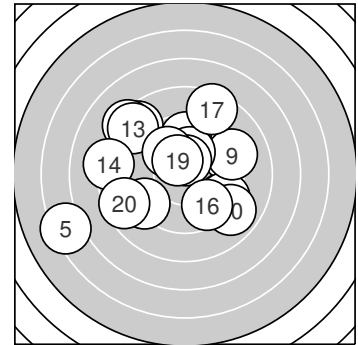

Serie 1:

9.4 ↘	9.3 ↗	9.2 ↙	8.6 ↘	6.3 ↙
10.0 ↘	9.6 ↑	9.3 ↘	9.1 ↗	8.9 ↘

beste Teiler: 228.6 (6.), 327.0 (7.), 397.8 (1.)
 Trefferlage: 0.06 mm links, 0.19 mm tief
 Streuwert: 4.10, horizontal: 4.89, vertikal: 3.11

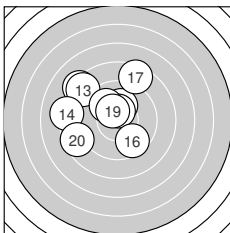

Serie 2:

8.3 ↘	10.2 *	8.5 ↘	8.2 ←	10.5 *
9.6 ↘	8.5 ↑	10.0 ↘	10.4 *	8.6 ↙

beste Teiler: 122.4 (15.), 138.7 (19.), 199.4 (12.)
 Trefferlage: 1.91 mm links, 1.60 mm hoch
 Streuwert: 3.03, horizontal: 3.29, vertikal: 2.75



Ergebnis: **0.0** (0)_{DNS}
Serien:
Zähler: 0 0 0 0 0 0 0 0 0 0
Innenzehner: 0
Weiteste:
~~beste Teiler~~
Trefferlage: 0.00 mm , 0.00 mm
Streuwert:

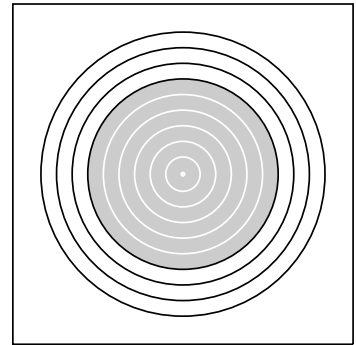

Ergebnis: **193.5** (186)
 Serien: 96.9 96.6
 Zähler: 8 10 2 0 0 0 0 0 0 0
 Innenzehner: 7
 Weitesten: 550 (2.), 509 (7.), 489 (11.)
 beste Teiler: 43.0 (8.), 88.7 (5.), 122.0 (13.)
 Trefferlage: 0.35 mm links, 0.45 mm hoch
 Streuwert: 2.55, horizontal: 3.25, vertikal: 1.56

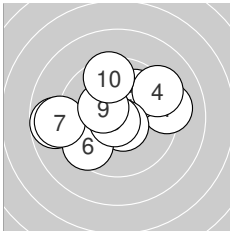
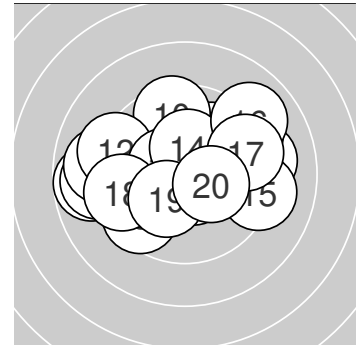

Serie 1:

9.2 →	8.8 ←	10.0 ↗	9.3 ↗	10.6 *
9.5 ↙	8.9 ←	10.8 *	10.3 *	9.5 ↑

beste Teiler: 43.0 (8.), 88.7 (5.), 152.5 (9.)
 Trefferlage: 0.55 mm links, 0.50 mm hoch
 Streuwert: 2.61, horizontal: 3.26, vertikal: 1.74

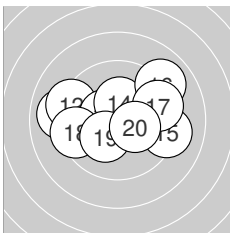

Serie 2:

9.0 ←	9.2 ←	10.5 *	10.3 *	9.2 →
9.0 ↗	9.5 →	9.4 ←	10.2 *	10.3 *

beste Teiler: 122.0 (13.), 156.9 (14.), 163.9 (20.)
 Trefferlage: 0.15 mm links, 0.41 mm hoch
 Streuwert: 2.61, horizontal: 3.40, vertikal: 1.46



Ergebnis: **159.9** (150)
Serien: 84.1 75.8
Zähler: 1 4 8 2 3 1 0 1 0 0
Innenzehner: 1
Weiteste: 1874 (15.), 1458 (14.), 1233 (6.)
beste Teiler: 79.0 (10.), 298.8 (1.), 442.3 (5.)
Trefferlage: 2.87 mm links, 0.69 mm tief
Streuwert: 5.74, horizontal: 6.36, vertikal: 5.03

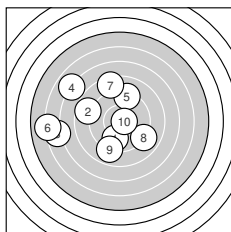
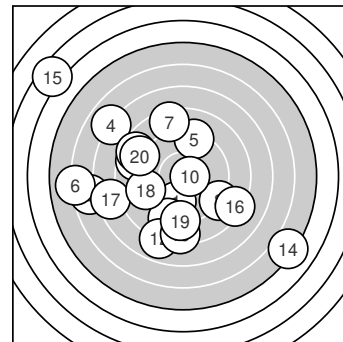

Serie 1:

9.8 ↓	8.7 ↖	6.6 ←	6.9 ↗	9.2 ↑
6.0 ←	8.4 ↑	9.0 ↘	8.9 ↓	10.6 *

beste Teiler: 79.0 (10.), 298.8 (1.), 442.3 (5.)
Trefferlage: 3.44 mm links, 0.44 mm hoch
Streuwert: 4.74, horizontal: 5.45, vertikal: 3.89

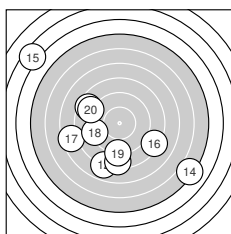

Serie 2:

8.5 ↖	7.9 ↓	8.3 ↓	5.1 ↘	3.5 ↖
8.2 ↘	7.5 ←	9.1 ←	8.9 ↓	8.8 ↖

beste Teiler: 452.3 (18.), 507.8 (19.), 544.8 (20.)
Trefferlage: 2.31 mm links, 1.82 mm tief
Streuwert: 6.72, horizontal: 7.42, vertikal: 5.95



Ergebnis: **184.9** (175)
Serien: 91.4 93.5
Zähler: 6 7 3 4 0 0 0 0 0 0
Innenzehner: 4
Weiteste: 841 (18.), 828 (3.), 828 (19.)
beste Teiler: 84.8 (12.), 118.4 (13.), 126.2 (11.)
Trefferlage: 0.46 mm links, 0.24 mm tief
Streuwert: 3.60, horizontal: 3.82, vertikal: 3.36

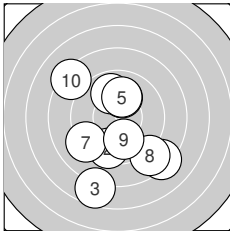
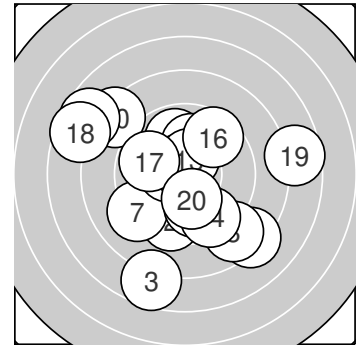

Serie 1:

10.1 ↑	9.5 ↓	7.6 ↓	9.9 ↑	10.0 ↑
8.2 ↘	9.2 ↙	8.7 ↘	9.9 ↓	8.3 ↖

beste Teiler: 224.1 (1.), 230.8 (5.), 254.2 (9.)
Trefferlage: 0.29 mm links, 1.42 mm tief
Streuwert: 3.56, horizontal: 3.07, vertikal: 3.98

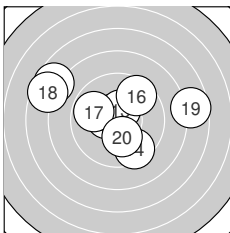

Serie 2:

10.4 *	10.6 *	10.5 *	9.5 ↓	7.7 ↖
9.6 ↗	9.8 ↖	7.6 ↖	7.6 →	10.2 *

beste Teiler: 84.8 (12.), 118.4 (13.), 126.2 (11.)
Trefferlage: 0.63 mm links, 0.93 mm hoch
Streuwert: 3.62, horizontal: 4.61, vertikal: 2.21



Ergebnis: **197.5** (190)
 Serien: 98.5 99.0
 Zähler: 10 10 0 0 0 0 0 0 0 0
 Innenzehner: 6
 Weitestе: 490 (13.), 479 (6.), 414 (3.)
 beste Teiler: 60.3 (9.), 101.1 (15.), 105.9 (7.)
 Trefferlage: 0.29 mm rechts, 0.33 mm tief
 Streuwert: 2.12, horizontal: 2.32, vertikal: 1.90

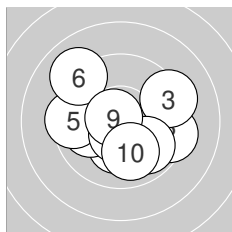
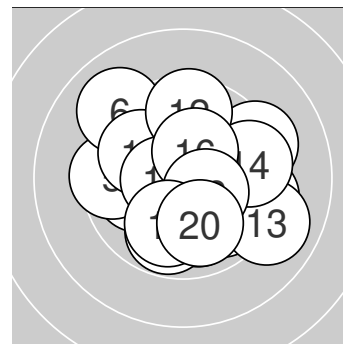

Serie 1:

10.2 *	9.4 ↗	9.3 ↗	10.0 ←	9.5 ←
9.0 ↘	10.5 *	9.9 ↘	10.7 *	10.0 ↓

beste Teiler: 60.3 (9.), 105.9 (7.), 186.7 (1.)
 Trefferlage: 0.00 mm , 0.29 mm tief
 Streuwert: 2.27, horizontal: 2.65, vertikal: 1.81

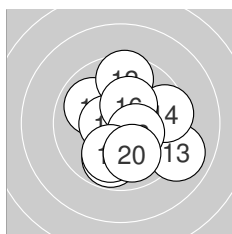

Serie 2:

9.9 ↘	9.6 ↑	9.0 ↘	9.5 →	10.5 *
10.3 *	9.8 ↓	10.4 *	10.0 ↓	10.0 ↓

beste Teiler: 101.1 (15.), 138.7 (18.), 153.5 (16.)
 Trefferlage: 0.60 mm rechts, 0.36 mm tief
 Streuwert: 2.05, horizontal: 2.02, vertikal: 2.08



Ergebnis: **187.0** (179)
 Serien: 91.3 95.7
 Zähler: 7 7 4 2 0 0 0 0 0 0
 Innenezehner: 4
 Weitester: 805 (5.), 756 (2.), 747 (7.)
 beste Teiler: 58.4 (19.), 87.1 (9.), 149.7 (16.)
 Trefferlage: 0.27 mm links, 0.79 mm tief
 Streuwert: 3.24, horizontal: 3.82, vertikal: 2.54

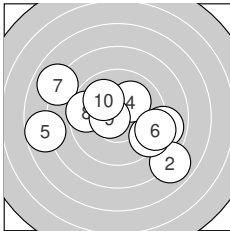
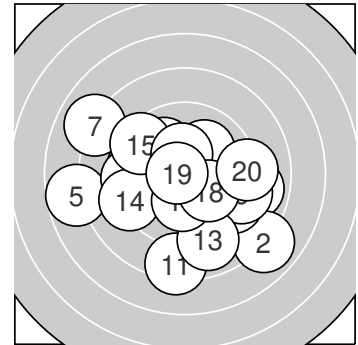

Serie 1:

8.9 →	7.9 ↘	9.3 ↘	10.1 ↗	7.7 ←
9.2 →	8.0 ↖	9.6 ←	10.6 *	10.0 ↖

beste Teiler: 87.1 (9.), 221.6 (4.), 243.1 (10.)
 Trefferlage: 0.05 mm links, 0.32 mm tief
 Streuwert: 3.82, horizontal: 4.82, vertikal: 2.42

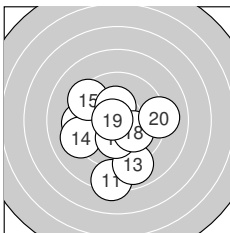

Serie 2:

8.3 ↓	9.4 ←	8.9 ↓	9.2 ←	9.4 ↖
10.4 *	10.2 *	10.1 ↘	10.7 *	9.1 →

beste Teiler: 58.4 (19.), 149.7 (16.), 193.9 (17.)
 Trefferlage: 0.48 mm links, 1.25 mm tief
 Streuwert: 2.72, horizontal: 2.72, vertikal: 2.71



LG 20 ZR – Wertung –
StandNr: 127
Leitner, Theo #70817804

Jugend_II_männl.

StartNr: 27
28. Oktober 2021 20:29
NÖ – SV Gaming

Ergebnis: **0.0** (0)_{DNS}
Serien:
Zähler: 0 0 0 0 0 0 0 0 0 0
Innenzehner: 0
Weiteste:
~~beste Teiler~~
Trefferlage: 0.00 mm , 0.00 mm
Streuwert:

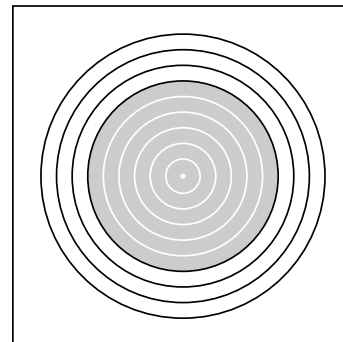

Ergebnis: **182.1** (175)
 Serien: 90.0 92.1
 Zähler: 4 9 5 2 0 0 0 0 0 0
 Innenzehner: 2
 Weitester: 952 (1.), 905 (2.), 668 (16.)
 beste Teiler: 155.6 (3.), 156.9 (17.), 214.5 (10.)
 Trefferlage: 1.47 mm links, 0.79 mm tief
 Streuwert: 3.48, horizontal: 4.01, vertikal: 2.85

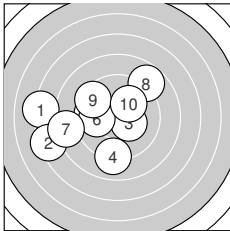
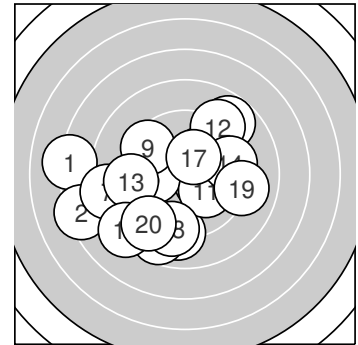

Serie 1:

7.1 ←	7.3 ←	10.3 *	9.0 ↓	9.7 ←
9.9 ←	8.3 ←	8.8 ↗	9.5 ↘	10.1 ↗

beste Teiler: 155.6 (3.), 214.5 (10.), 256.5 (6.)
 Trefferlage: 2.73 mm links, 0.07 mm tief
 Streuwert: 3.59, horizontal: 4.34, vertikal: 2.62

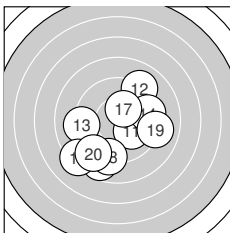

Serie 2:

10.1 ↘	9.1 ↗	9.2 ←	9.4 →	8.7 ↓
8.3 ↙	10.3 *	9.1 ↓	9.0 →	8.9 ↙

beste Teiler: 156.9 (17.), 216.8 (11.), 379.3 (14.)
 Trefferlage: 0.20 mm links, 1.52 mm tief
 Streuwert: 3.22, horizontal: 3.39, vertikal: 3.03



Ergebnis: **197.6** (187)
 Serien: 101.0 96.6
 Zähler: 10 7 3 0 0 0 0 0 0 0
 Innenzehner: 8
 Weitesten: 550 (16.), 543 (20.), 514 (2.)
 beste Teiler: 45.2 (9.), 50.2 (12.), 64.4 (1.)
 Trefferlage: 0.67 mm rechts, 0.32 mm tief
 Streuwert: 2.24, horizontal: 2.92, vertikal: 1.23

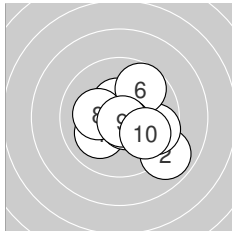
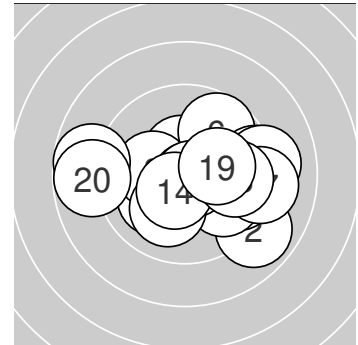

Serie 1:

10.7 *	8.9 ↘	10.5 *	10.1 ↙	9.6 →
9.7 ↗	10.6 *	10.2 *	10.8 *	9.9 ↘

beste Teiler: 45.2 (9.), 64.4 (1.), 80.0 (7.)
 Trefferlage: 0.76 mm rechts, 0.44 mm tief
 Streuwert: 1.78, horizontal: 1.99, vertikal: 1.55

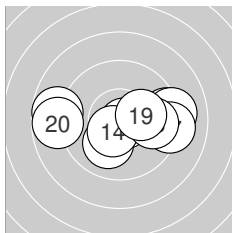

Serie 2:

9.3 →	10.8 *	10.1 ↙	10.5 *	9.1 →
8.8 ←	9.2 →	9.8 →	10.2 *	8.8 ←

beste Teiler: 50.2 (12.), 114.0 (14.), 193.5 (19.)
 Trefferlage: 0.57 mm rechts, 0.20 mm tief
 Streuwert: 2.72, horizontal: 3.75, vertikal: 0.85



Ergebnis: **186.4** (179)
 Serien: 93.9 92.5
 Zähler: 6 9 3 2 0 0 0 0 0 0
 Innenzehner: 5
 Weitester: 885 (17.), 861 (12.), 748 (2.)
 beste Teiler: 83.6 (7.), 121.2 (20.), 143.9 (9.)
 Trefferlage: 2.18 mm links, 0.85 mm tief
 Streuwert: 2.95, horizontal: 3.51, vertikal: 2.25

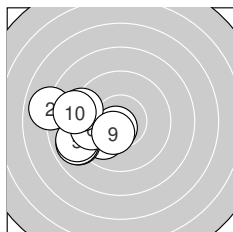
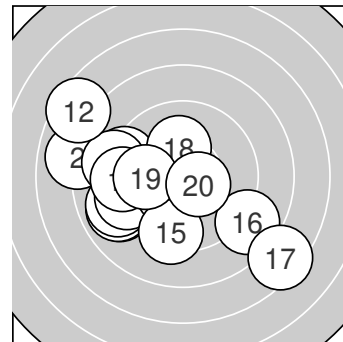

Serie 1:

10.0 ↙	8.0 ←	9.0 ←	8.9 ←	9.0 ←
9.7 ←	10.6 *	9.3 ←	10.4 *	9.0 ←

beste Teiler: 83.6 (7.), 143.9 (9.), 249.6 (1.)
 Trefferlage: 3.58 mm links, 0.74 mm tief
 Streuwert: 1.79, horizontal: 2.09, vertikal: 1.44

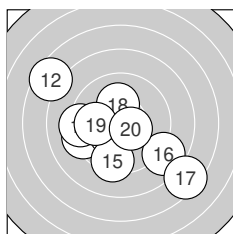

Serie 2:

9.3 ←	7.5 ↘	10.3 *	9.3 ←	9.4 ↓
8.7 ↘	7.4 ↘	10.2 *	9.9 ←	10.5 *

beste Teiler: 121.2 (20.), 154.1 (13.), 198.9 (18.)
 Trefferlage: 0.78 mm links, 0.96 mm tief
 Streuwert: 3.60, horizontal: 4.17, vertikal: 2.92

