

Ergebnis: **165.8** (156)
 Serien: 89.2 76.6
 Zähler: 1 6 8 2 1 1 0 1 0 0
 Innenzehner: 1
 weiteste: 1782 (18), 1497 (20), 1092 (15)
 beste Teiler 184.8 (1.) 306.1 (7.) 311.0 (3.)
 Trefferlage 0.10 mm links, 2.27 mm hoch
 Streuwert 5.36, horizontal: 6.67, vertikal: 3.61

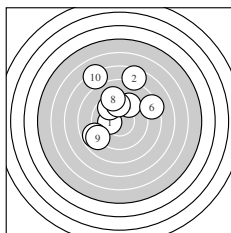

Serie 1:
 10.2 * 7.6 ↑ 9.7 ↘ 9.6 ↗ 8.8 ↙
 8.3 → 9.7 ↑ 9.2 ↑ 8.9 ↙ 7.2 ↘
 beste Teiler 184.8 (1.) 306.1 (7.) 311.0 (3.)
 Trefferlage 0.80 mm links, 2.57 mm hoch
 Streuwert 3.63, horizontal: 3.44, vertikal: 3.81

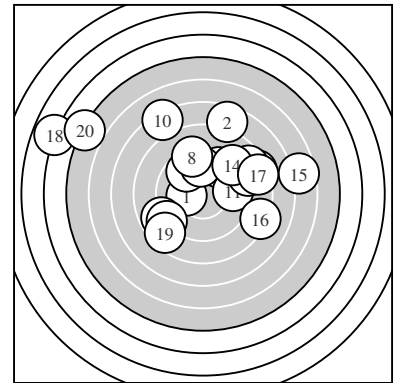
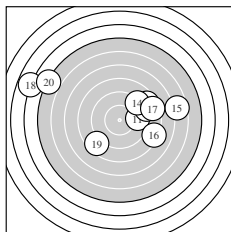

Serie 2:
 9.6 → 8.8 → 8.6 → 9.1 ↗ 6.6 →
 8.2 → 8.4 → 3.8 ← 8.5 ↙ 5.0 ↘
 beste Teiler 336.6 (11.) 458.9 (14.) 541.4 (12.)
 Trefferlage 0.59 mm rechts, 1.97 mm hoch
 Streuwert 6.85, horizontal: 9.00, vertikal: 3.58

Unterschrift des Schützen

Ergebnis: **168.1** (158)
 Serien: 82.3 85.8
 Zähler: 2 8 5 2 1 1 0 0 0 1
 Innenzehner: 2
 weiteste: 2286 (1), 1288 (4), 1119 (11)
 beste Teiler 120.4 (8.) 157.8 (2.) 269.8 (7.)
 Trefferlage 1.69 mm links, 1.19 mm tief
 Streuwert 5.57, horizontal: 5.49, vertikal: 5.65

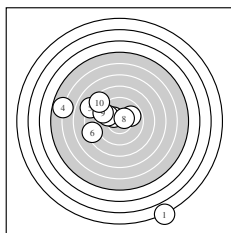
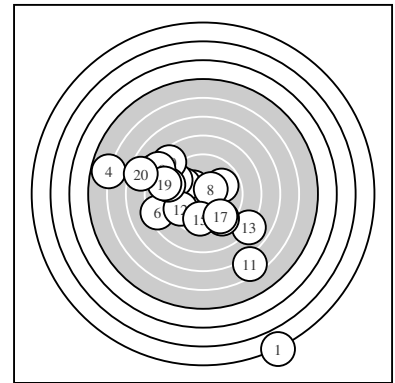

Serie 1:
 1.8 ↘ 10.3 * 9.8 ↖ 5.8 ← 8.1 ↖
 8.3 ← 9.9 → 10.5 * 9.3 ↖ 8.5 ↖
 beste Teiler 120.4 (8.) 157.8 (2.) 269.8 (7.)
 Trefferlage 2.36 mm links, 0.72 mm tief
 Streuwert 6.65, horizontal: 6.03, vertikal: 7.21

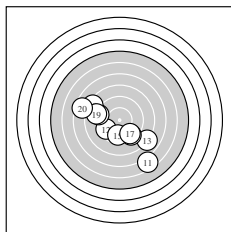

Serie 2:
 6.5 ↘ 9.5 ↖ 7.9 ↘ 9.3 ↘ 9.6 ↓
 9.0 ← 9.5 ↘ 8.2 ↖ 8.8 ← 7.5 ←
 beste Teiler 331.4 (15.) 358.8 (12.) 375.8 (17.)
 Trefferlage 1.02 mm links, 1.66 mm tief
 Streuwert 4.54, horizontal: 5.13, vertikal: 3.87

Unterschrift des Schützen

Ergebnis: **201.6** (195)
 Serien: 99.8 101.8
 Zähler: 15 5 0 0 0 0 0 0 0 0
 Innenzehner: 11
 weiteste: 491 (13), 442 (4), 398 (9)
 beste Teiler 68.8 (5.) 84.0 (20.) 89.5 (6.)
 Trefferlage 0.08 mm rechts, 0.24 mm hoch
 Streuwert 1.82, horizontal: 1.92, vertikal: 1.72

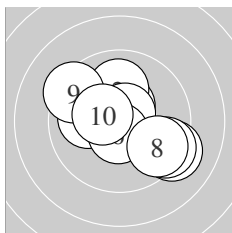
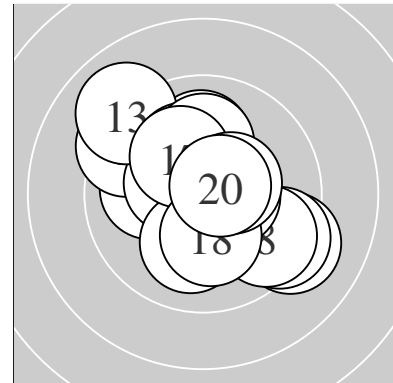

Serie 1:
 10.5 * 10.0 ↑ 10.0 ← 9.2 ↘ 10.7 *
 10.6 * 9.4 ↘ 9.6 ↘ 9.4 ↖ 10.4 *
 beste Teiler 68.8 (5.) 89.5 (6.) 118.9 (1.)
 Trefferlage 0.36 mm rechts, 0.00 mm
 Streuwert 2.06, horizontal: 2.39, vertikal: 1.65

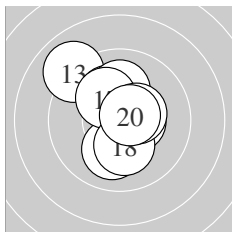

Serie 2:
 10.5 * 10.5 * 9.0 ↘ 10.1 ↓ 10.2 *
 10.1 ↑ 10.2 * 10.2 * 10.4 * 10.6 *
 beste Teiler 84.0 (20.) 111.1 (11.) 117.4 (12.)
 Trefferlage 0.19 mm links, 0.48 mm hoch
 Streuwert 1.62, horizontal: 1.37, vertikal: 1.84

Unterschrift des Schützen

Ergebnis: **187.2** (179)
 Serien: 91.3 95.9
 Zähler: 7 6 6 1 0 0 0 0 0 0
 Innenzehner: 4
 weiteste: 768 (2), 733 (6), 732 (8)
 beste Teiler 143.3 (7.) 158.7 (18.) 182.1 (20.)
 Trefferlage 1.61 mm rechts, 0.65 mm tief
 Streuwert 3.03, horizontal: 3.66, vertikal: 2.23

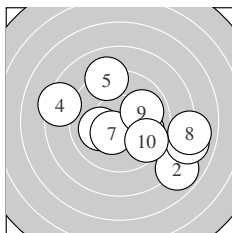
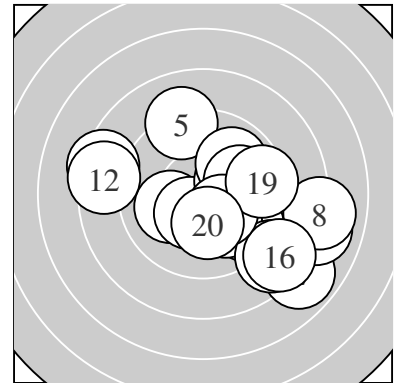

Serie 1:
 10.1 ← 7.9 ↘ 9.9 → 8.4 ← 9.1 ↑
 8.0 → 10.4 * 8.0 → 9.9 → 9.6 ↘
 beste Teiler 143.3 (7.) 217.2 (1.) 251.7 (9.)
 Trefferlage 1.72 mm rechts, 0.60 mm tief
 Streuwert 3.55, horizontal: 4.35, vertikal: 2.50

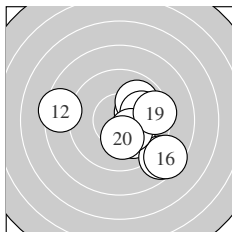

Serie 2:
 10.2 * 8.5 ← 10.1 ↘ 8.7 ↘ 9.9 ↗
 8.5 ↘ 10.0 → 10.3 * 9.5 → 10.2 *
 beste Teiler 158.7 (18.) 182.1 (20.) 188.3 (11.)
 Trefferlage 1.51 mm rechts, 0.69 mm tief
 Streuwert 2.60, horizontal: 3.04, vertikal: 2.06

Unterschrift des Schützen

Ergebnis: **190.8** (183)
 Serien: 97.4 93.4
 Zähler: 10 5 3 2 0 0 0 0 0 0
 Innenzehner: 6
 weiteste: 984 (9), 857 (20), 655 (8)
 beste Teiler 40.4 (1.) 48.0 (4.) 80.2 (17.)
 Trefferlage 1.01 mm links, 0.39 mm tief
 Streuwert 3.06, horizontal: 3.98, vertikal: 1.70

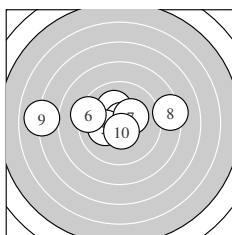
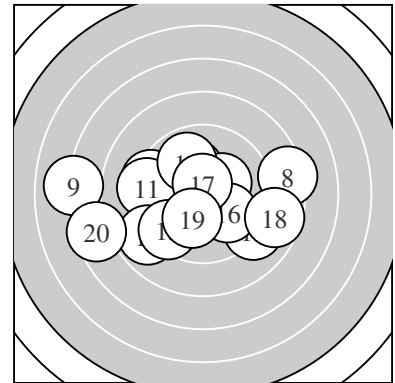

Serie 1:
 10.8 * 10.1 ← 10.1 ↗ 10.8 * 10.2 *
 9.3 ← 10.3 * 8.3 → 7.0 ← 10.5 *
 beste Teiler 40.4 (1.) 48.0 (4.) 104.5 (10.)
 Trefferlage 1.01 mm links, 0.48 mm hoch
 Streuwert 2.99, horizontal: 4.13, vertikal: 0.91

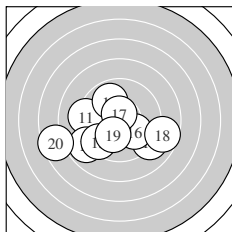

Serie 2:
 9.2 ← 8.9 ↙ 9.4 ↘ 9.1 ↘ 9.9 ↗
 10.0 ↘ 10.6 * 8.7 → 10.1 ↓ 7.5 ←
 beste Teiler 80.2 (17.) 201.8 (19.) 235.4 (16.)
 Trefferlage 1.02 mm links, 1.28 mm tief
 Streuwert 3.15, horizontal: 4.04, vertikal: 1.87

Unterschrift des Schützen

Ergebnis: **177.8** (168)
 Serien: 87.4 90.4
 Zähler: 4 8 3 3 1 1 0 0 0 0
 Innenzehner: 3
 weiteste: 1372 (5), 1207 (10), 977 (17)
 beste Teiler 85.5 (20.) 116.4 (1.) 148.1 (18.)
 Trefferlage 0.36 mm rechts, 1.44 mm hoch
 Streuwert 4.39, horizontal: 4.95, vertikal: 3.75

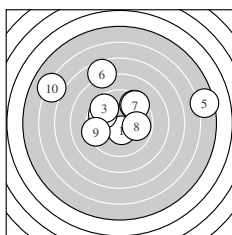
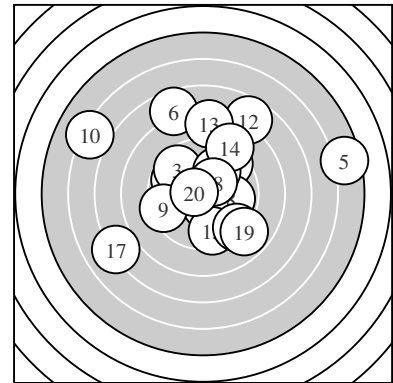

Serie 1:
 10.5 * 9.8 ↖ 9.6 ↖ 9.5 ↗ 5.5 →
 7.6 ↖ 9.5 ↗ 9.9 → 9.4 ← 6.1 ↖
 beste Teiler 116.4 (1.) 269.9 (8.) 296.5 (2.)
 Trefferlage 0.12 mm links, 2.30 mm hoch
 Streuwert 4.84, horizontal: 6.20, vertikal: 2.91

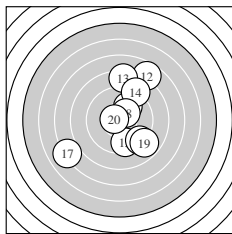

Serie 2:
 10.0 ↗ 7.7 ↗ 8.3 ↑ 8.9 ↗ 9.5 ↓
 9.2 ↘ 7.0 ← 10.4 * 8.8 ↘ 10.6 *
 beste Teiler 85.5 (20.) 148.1 (18.) 249.8 (11.)
 Trefferlage 0.85 mm rechts, 0.59 mm hoch
 Streuwert 4.03, horizontal: 3.58, vertikal: 4.43

Unterschrift des Schützen

Ergebnis: **196.0** (187)
 Serien: 96.3 99.7
 Zähler: 8 11 1 0 0 0 0 0 0 0
 Innenzehner: 6
 weiteste: 655 (18), 471 (6), 429 (5)
 beste Teiler 74.3 (13.) 104.3 (15.) 128.3 (11.)
 Trefferlage 0.10 mm links, 0.56 mm hoch
 Streuwert 2.28, horizontal: 2.68, vertikal: 1.80

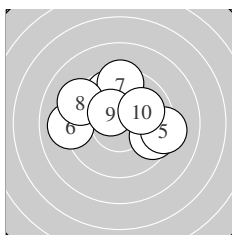
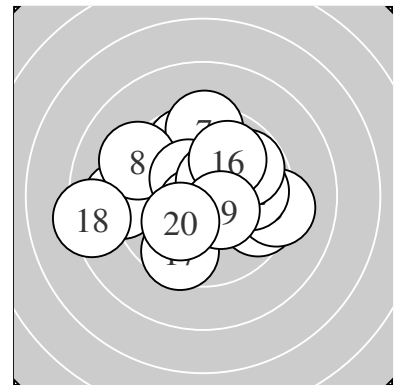

Serie 1:
 9.6 ↑ 9.7 ↖ 9.6 ↗ 10.1 ↘ 9.2 →
 9.1 ← 9.4 ↑ 9.2 ↖ 10.4 * 10.0 ↗
 beste Teiler 132.7 (9.) 212.2 (4.) 240.0 (10.)
 Trefferlage 0.21 mm links, 1.36 mm hoch
 Streuwert 2.34, horizontal: 2.83, vertikal: 1.71

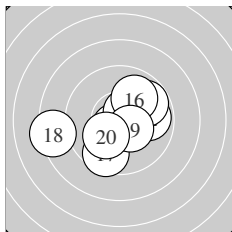

Serie 2:
 10.4 * 9.9 → 10.7 * 9.8 ↗ 10.5 *
 9.9 ↗ 9.6 ↓ 8.3 ← 10.4 * 10.2 *
 beste Teiler 74.3 (13.) 104.3 (15.) 128.3 (11.)
 Trefferlage 0.00 mm , 0.23 mm tief
 Streuwert 2.18, horizontal: 2.66, vertikal: 1.57

Unterschrift des Schützen

Ergebnis: **173.5** (165)
 Serien: 82.5 91.0
 Zähler: 0 11 7 0 1 0 1 0 0 0
 Innenzehner: 0
 weiteste: 1659 (5), 1053 (3), 715 (13)
 beste Teiler 282.3 (17.) 336.8 (12.) 351.5 (11.)
 Trefferlage 2.33 mm rechts, 1.11 mm tief
 Streuwert 4.28, horizontal: 5.12, vertikal: 3.23

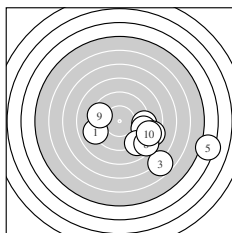
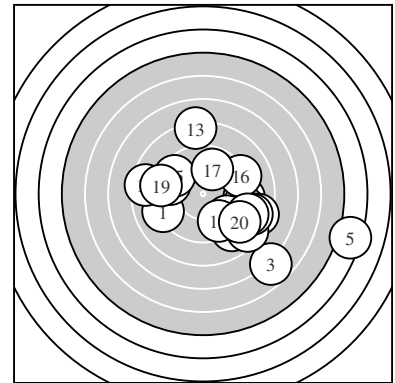

Serie 1:

9.1 ↙ 9.2 → 6.7 ↘ 9.2 → 4.3 →
 8.9 ↘ 8.4 → 8.5 ↘ 9.5 ← 8.7 →

beste Teiler 372.1 (9.) 444.7 (2.) 449.8 (4.)
 Trefferlage 4.32 mm rechts, 2.71 mm tief
 Streuwert 4.34, horizontal: 5.63, vertikal: 2.44

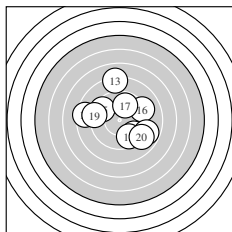

Serie 2:

9.5 ↘ 9.6 ↘ 8.1 ↑ 8.4 ← 9.5 ↖
 9.2 → 9.8 ↑ 8.8 → 9.1 ← 9.0 ↘

beste Teiler 282.3 (17.) 336.8 (12.) 351.5 (11.)
 Trefferlage 0.34 mm rechts, 0.49 mm hoch
 Streuwert 3.55, horizontal: 3.86, vertikal: 3.21

Unterschrift des Schützen

Ergebnis: **130.1** (121)
 Serien: 57.4 72.7
 Zähler: 1 2 4 2 5 1 1 2 0 2
 Innenzehner: 1
 weiteste: 2299 (10), 2297 (8), 1988 (14)
 beste Teiler 153.3 (11.) 433.0 (7.) 452.8 (15.)
 Trefferlage 2.95 mm links, 1.19 mm hoch
 Streuwert 8.90, horizontal: 9.66, vertikal: 8.07

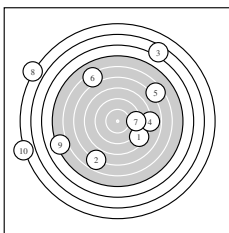
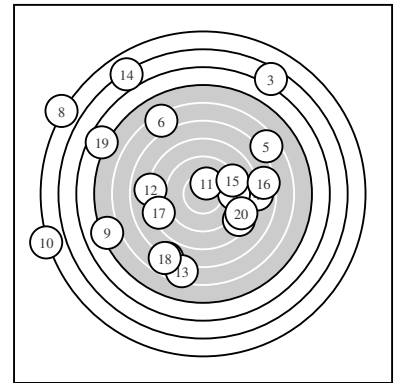

Serie 1:

8.5 ↘ 6.8 ↙ 3.5 ↗ 7.9 → 6.5 ↗
 6.2 ↘ 9.2 → 1.8 ↖ 5.2 ← 1.8 ←

beste Teiler 433.0 (7.) 620.0 (1.) 755.0 (4.)
 Trefferlage 3.07 mm links, 1.96 mm hoch
 Streuwert 10.45, horizontal: 11.97, vertikal: 8.66

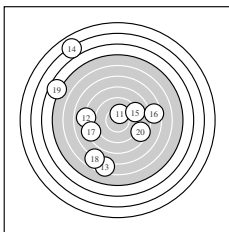

Serie 2:

10.3 * 8.0 ← 6.5 ↓ 3.0 ↘ 9.1 →
 7.5 → 8.3 ← 6.8 ↙ 4.6 ↖ 8.6 ↘

beste Teiler 153.3 (11.) 452.8 (15.) 600.6 (20.)
 Trefferlage 2.83 mm links, 0.43 mm hoch
 Streuwert 7.58, horizontal: 7.33, vertikal: 7.82

Unterschrift des Schützen

Ergebnis: **191.4** (181)
 Serien: 93.5 97.9
 Zähler: 7 7 6 0 0 0 0 0 0 0
 Innenzehner: 5
 weiteste: 636 (9), 574 (7), 553 (6)
 beste Teiler 86.9 (17.) 162.9 (4.) 164.1 (12.)
 Trefferlage 0.76 mm links, 0.87 mm hoch
 Streuwert 2.64, horizontal: 3.05, vertikal: 2.14

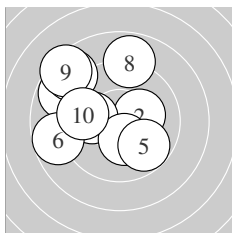
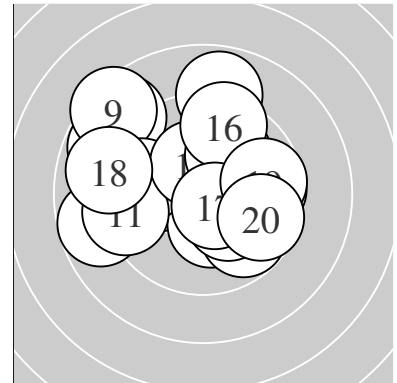

Serie 1:
 8.8 ↘ 10.2 * 10.0 ← 10.3 * 9.8 ↘
 8.7 ← 8.7 ↘ 8.9 ↑ 8.4 ↘ 9.7 ←
 beste Teiler 162.9 (4.) 179.9 (2.) 239.7 (3.)
 Trefferlage 1.94 mm links, 1.21 mm hoch
 Streuwert 2.78, horizontal: 2.92, vertikal: 2.63

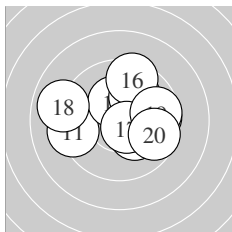

Serie 2:
 9.3 ← 10.3 * 10.2 * 10.0 ↗ 9.7 →
 9.5 ↑ 10.6 * 8.9 ← 9.7 → 9.7 →
 beste Teiler 86.9 (17.) 164.1 (12.) 179.6 (13.)
 Trefferlage 0.41 mm rechts, 0.52 mm hoch
 Streuwert 2.30, horizontal: 2.84, vertikal: 1.59

Unterschrift des Schützen

Ergebnis: **196.5** (187)
 Serien: 97.8 98.7
 Zähler: 10 8 1 1 0 0 0 0 0 0
 Innenzehner: 7
 weiteste: 845 (8), 522 (9), 434 (11)
 beste Teiler 47.4 (2.) 61.7 (3.) 87.9 (13.)
 Trefferlage 0.12 mm links, 0.24 mm hoch
 Streuwert 2.43, horizontal: 2.98, vertikal: 1.71

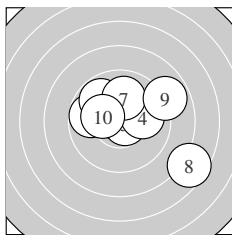
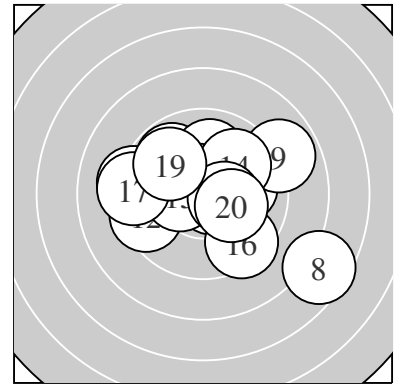

Serie 1:
 10.0 ↖ 10.8 * 10.7 * 10.0 → 9.8 ←
 9.8 ↘ 10.0 ↑ 7.6 ↘ 8.9 ↗ 10.2 *
 beste Teiler 47.4 (2.) 61.7 (3.) 180.7 (10.)
 Trefferlage 0.59 mm rechts, 0.46 mm hoch
 Streuwert 2.70, horizontal: 3.27, vertikal: 1.98

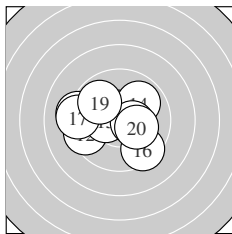

Serie 2:
 9.2 ← 9.5 ← 10.6 * 9.9 ↗ 10.4 *
 9.4 ↘ 9.2 ← 10.4 * 9.9 ↘ 10.2 *
 beste Teiler 87.9 (13.) 132.5 (18.) 142.1 (15.)
 Trefferlage 0.84 mm links, 0.01 mm hoch
 Streuwert 2.12, horizontal: 2.63, vertikal: 1.45

Unterschrift des Schützen

Ergebnis: **175.3** (167)
 Serien: 93.1 82.2
 Zähler: 4 6 7 1 1 0 1 0 0 0
 Innenzehner: 4
 weiteste: 1627 (18), 1150 (13), 944 (16)
 beste Teiler 90.8 (2.) 115.4 (10.) 182.6 (6.)
 Trefferlage 2.02 mm rechts, 0.50 mm tief
 Streuwert 4.53, horizontal: 5.48, vertikal: 3.33

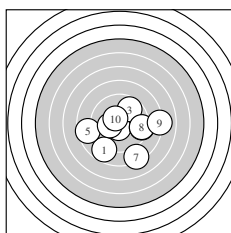
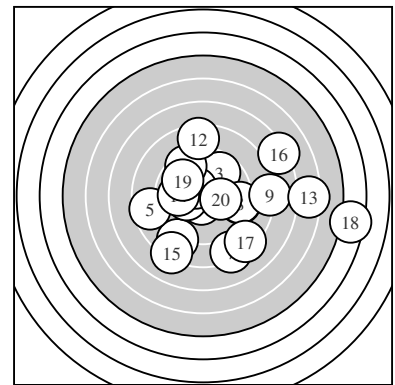

Serie 1:
 8.7 ↙ 10.6 * 9.7 ↗ 9.3 → 8.6 ←
 10.2 * 8.2 ↘ 9.3 → 8.0 → 10.5 *
 beste Teiler 90.8 (2.) 115.4 (10.) 182.6 (6.)
 Trefferlage 0.88 mm rechts, 1.15 mm tief
 Streuwert 3.26, horizontal: 3.86, vertikal: 2.53

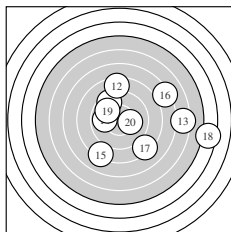

Serie 2:
 9.5 ↖ 8.4 ↑ 6.4 → 9.9 ← 8.1 ↙
 7.2 ↗ 8.3 ↘ 4.4 → 9.8 ↖ 10.2 *
 beste Teiler 194.9 (20.) 268.1 (14.) 280.0 (19.)
 Trefferlage 3.15 mm rechts, 0.15 mm hoch
 Streuwert 5.55, horizontal: 6.75, vertikal: 4.00

Unterschrift des Schützen

Ergebnis: **184.8** (175)
 Serien: 92.4 92.4
 Zähler: 5 6 8 1 0 0 0 0 0 0
 Innenzehner: 4
 weiteste: 876 (18), 683 (9), 648 (15)
 beste Teiler 73.2 (4.) 135.6 (13.) 168.1 (3.)
 Trefferlage 0.72 mm links, 0.07 mm hoch
 Streuwert 3.41, horizontal: 4.11, vertikal: 2.53

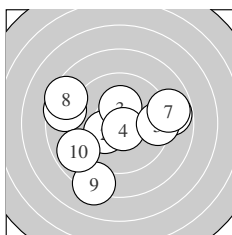
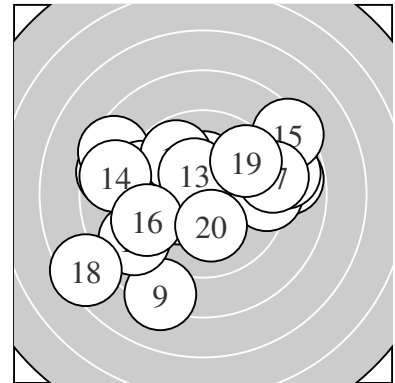

Serie 1:
 8.8 → 10.2 * 10.3 * 10.7 * 9.4 →
 8.6 ← 8.8 → 8.5 ↖ 8.2 ↓ 8.9 ↙
 beste Teiler 73.2 (4.) 168.1 (3.) 178.5 (2.)
 Trefferlage 0.49 mm links, 0.28 mm tief
 Streuwert 3.52, horizontal: 4.22, vertikal: 2.63

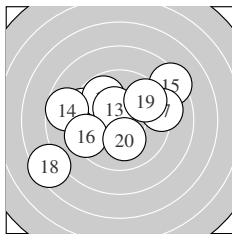

Serie 2:
 9.4 ↖ 9.8 ↖ 10.4 * 8.7 ← 8.4 ↗
 9.4 ← 9.2 → 7.4 ↙ 9.6 ↗ 10.1 ↓
 beste Teiler 135.6 (13.) 205.1 (20.) 291.0 (12.)
 Trefferlage 0.95 mm links, 0.42 mm hoch
 Streuwert 3.47, horizontal: 4.22, vertikal: 2.51

Unterschrift des Schützen

Ergebnis: **173.2** (163)
 Serien: 85.8 87.4
 Zähler: 0 9 8 1 1 1 0 0 0 0
 Innenzehner: 0
 weiteste: 1388 (13), 1055 (4), 855 (3)
 beste Teiler 308.6 (11.) 312.5 (15.) 321.3 (16.)
 Trefferlage 0.55 mm links, 0.60 mm hoch
 Streuwert 4.54, horizontal: 5.39, vertikal: 3.49

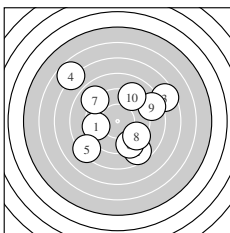
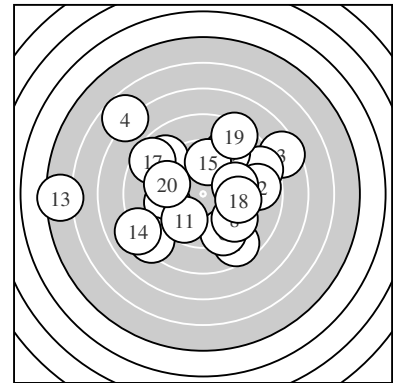

Serie 1:

9.5 ← 8.6 ↘ 7.5 → 6.7 ↖ 8.3 ↙
 9.3 ↘ 8.9 ↖ 9.4 ↘ 8.5 → 9.1 ↗

beste Teiler 358.7 (1.) 389.6 (8.) 421.8 (6.)
 Trefferlage 0.40 mm rechts, 0.47 mm hoch
 Streuwert 4.64, horizontal: 5.00, vertikal: 4.26

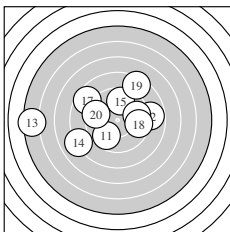

Serie 2:

9.7 ↙ 8.8 → 5.4 ← 8.0 ↖ 9.7 ↑
 9.7 → 8.6 ↖ 9.6 → 8.4 ↗ 9.5 ←

beste Teiler 308.6 (11.) 312.5 (15.) 321.3 (16.)
 Trefferlage 1.50 mm links, 0.73 mm hoch
 Streuwert 4.58, horizontal: 5.86, vertikal: 2.76

Unterschrift des Schützen

Ergebnis: **172.2** (165)
 Serien: 86.0 86.2
 Zähler: 2 5 9 4 0 0 0 0 0 0
 Innenzehner: 1
 weiteste: 917 (10), 899 (5), 810 (8)
 beste Teiler 182.9 (9.) 237.3 (3.) 327.4 (16.)
 Trefferlage 1.26 mm links, 2.03 mm hoch
 Streuwert 4.13, horizontal: 4.99, vertikal: 3.03

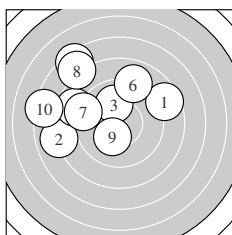
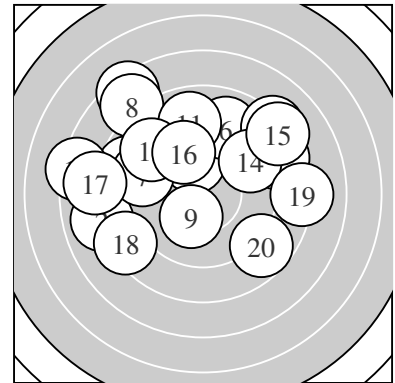

Serie 1:
 8.6 ↗ 8.0 ← 10.0 ↑ 8.7 ↖ 7.4 ↘
 9.0 ↗ 9.1 ← 7.7 ↖ 10.2 * 7.3 ←

beste Teiler 182.9 (9.) 237.3 (3.) 453.8 (7.)
 Trefferlage 3.08 mm links, 2.46 mm hoch
 Streuwert 3.74, horizontal: 4.37, vertikal: 2.98

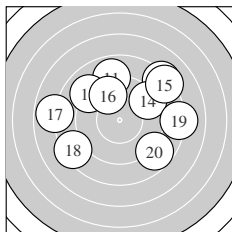

Serie 2:
 8.9 ↑ 9.0 ↖ 8.2 ↗ 9.3 ↗ 8.2 ↗
 9.6 ↘ 7.9 ← 8.3 ↖ 8.1 → 8.7 ↘

beste Teiler 327.4 (16.) 410.8 (14.) 483.6 (12.)
 Trefferlage 0.56 mm rechts, 1.61 mm hoch
 Streuwert 4.26, horizontal: 5.11, vertikal: 3.19

Unterschrift des Schützen

Ergebnis: **187.2** (180)
 Serien: 91.8 95.4
 Zähler: 7 10 1 1 0 1 0 0 0 0
 Innenzehner: 5
 weiteste: 1497 (8), 970 (15), 561 (2)
 beste Teiler 128.1 (16.) 139.0 (17.) 177.0 (3.)
 Trefferlage 1.17 mm links, 0.44 mm tief
 Streuwert 3.56, horizontal: 4.44, vertikal: 2.36

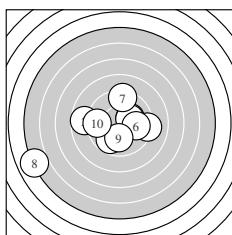
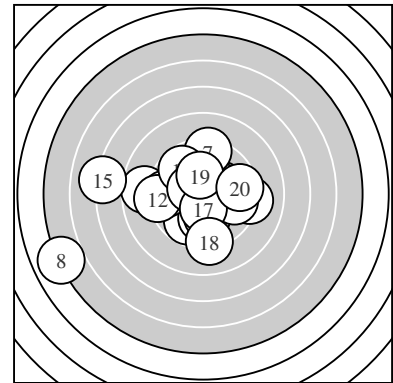

Serie 1:
 10.2 * 8.7 ← 10.2 * 9.2 → 9.8 ↙
 9.9 → 9.3 ↑ 5.0 ↖ 10.0 ↓ 9.5 ←
 beste Teiler 177.0 (3.) 188.7 (1.) 232.3 (9.)
 Trefferlage 1.35 mm links, 0.62 mm tief
 Streuwert 4.16, horizontal: 5.21, vertikal: 2.73

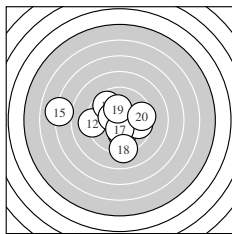

Serie 2:
 10.1 ↓ 9.2 ← 9.7 ↘ 9.7 → 7.1 ←
 10.4 * 10.4 * 9.1 ↓ 10.2 * 9.5 →
 beste Teiler 128.1 (16.) 139.0 (17.) 181.4 (19.)
 Trefferlage 0.98 mm links, 0.26 mm tief
 Streuwert 3.05, horizontal: 3.79, vertikal: 2.07

Unterschrift des Schützen

Ergebnis: **173.2** (164)
 Serien: 86.1 87.1
 Zähler: 2 7 7 2 1 1 0 0 0 0
 Innenzehner: 2
 weiteste: 1309 (10), 1196 (19), 866 (2)
 beste Teiler 56.1 (4.) 74.9 (14.) 338.8 (8.)
 Trefferlage 0.74 mm rechts, 0.38 mm hoch
 Streuwert 4.68, horizontal: 5.70, vertikal: 3.38

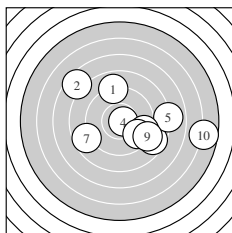
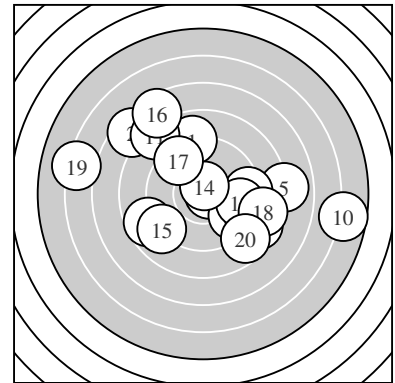

Serie 1:
 8.9 ↑ 7.5 ↘ 8.6 ↘ 10.7 * 8.0 →
 9.4 → 8.7 ← 9.6 ↘ 9.0 ↘ 5.7 →
 beste Teiler 56.1 (4.) 338.8 (8.) 400.1 (6.)
 Trefferlage 2.42 mm rechts, 0.20 mm tief
 Streuwert 4.64, horizontal: 5.78, vertikal: 3.11

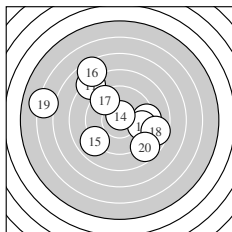

Serie 2:
 8.2 ↘ 9.3 → 9.5 → 10.7 * 9.0 ↙
 7.5 ↘ 9.4 ↘ 8.6 → 6.2 ← 8.7 ↘
 beste Teiler 74.9 (14.) 353.4 (13.) 381.2 (17.)
 Trefferlage 0.92 mm links, 0.97 mm hoch
 Streuwert 4.61, horizontal: 5.38, vertikal: 3.70

Unterschrift des Schützen

Ergebnis: **191.4** (183)
 Serien: 95.7 95.7
 Zähler: 5 13 2 0 0 0 0 0 0 0
 Innenzehner: 3
 weiteste: 635 (7), 587 (13), 494 (12)
 beste Teiler 57.3 (15.) 115.1 (6.) 161.9 (2.)
 Trefferlage 1.58 mm rechts, 0.71 mm hoch
 Streuwert 2.39, horizontal: 2.85, vertikal: 1.82

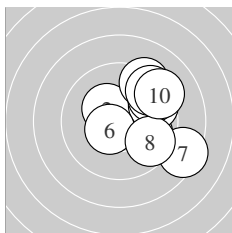
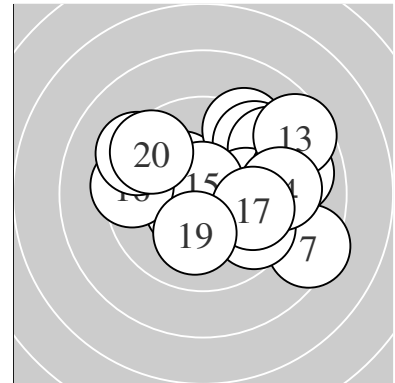

Serie 1:
 9.9 ↘ 10.3 * 9.6 ↗ 9.5 ↗ 9.3 ↗
 10.5 * 8.4 ↘ 9.6 ↘ 9.4 ↗ 9.2 ↗
 beste Teiler 115.1 (6.) 161.9 (2.) 275.8 (1.)
 Trefferlage 2.35 mm rechts, 0.69 mm hoch
 Streuwert 2.09, horizontal: 2.02, vertikal: 2.15

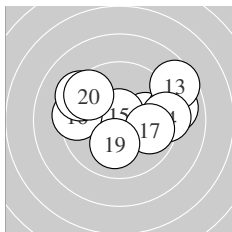

Serie 2:
 10.0 → 9.0 → 8.6 ↗ 9.3 → 10.7 *
 9.4 ← 9.8 ↘ 9.3 ↖ 10.1 ↓ 9.5 ↖
 beste Teiler 57.3 (15.) 215.5 (19.) 232.2 (11.)
 Trefferlage 0.82 mm rechts, 0.73 mm hoch
 Streuwert 2.66, horizontal: 3.43, vertikal: 1.54

Unterschrift des Schützen

Ergebnis: **185.8** (180)
 Serien: 92.8 93.0
 Zähler: 9 4 5 2 0 0 0 0 0 0
 Innenzehner: 5
 weiteste: 970 (7), 929 (11), 698 (19)
 beste Teiler 56.2 (20.) 136.4 (6.) 160.5 (2.)
 Trefferlage 1.04 mm rechts, 0.16 mm tief
 Streuwert 3.53, horizontal: 4.41, vertikal: 2.33

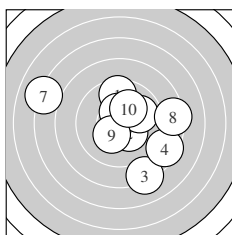
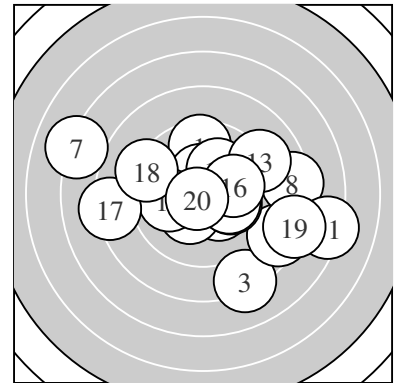

Serie 1:
 9.6 ↑ 10.3 * 8.2 ↘ 8.5 ↘ 9.9 ↗
 10.4 * 7.1 ↖ 8.4 → 10.3 * 10.1 ↗
 beste Teiler 136.4 (6.) 160.5 (2.) 165.8 (9.)
 Trefferlage 0.89 mm rechts, 0.00 mm
 Streuwert 3.69, horizontal: 4.27, vertikal: 3.00

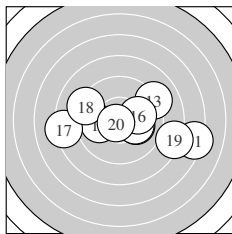

Serie 2:
 7.2 → 10.1 → 9.1 ↗ 10.2 * 10.0 ←
 10.1 → 8.2 ← 9.2 ↖ 8.2 → 10.7 *
 beste Teiler 56.2 (20.) 197.6 (14.) 209.0 (12.)
 Trefferlage 1.20 mm rechts, 0.33 mm tief
 Streuwert 3.55, horizontal: 4.78, vertikal: 1.55

Unterschrift des Schützen

Ergebnis: **182.1** (173)
 Serien: 91.7 90.4
 Zähler: 4 9 4 2 1 0 0 0 0 0
 Innenzehner: 4
 weiteste: 1030 (11), 960 (2), 755 (20)
 beste Teiler 116.0 (16.) 147.2 (8.) 147.2 (18.)
 Trefferlage 0.16 mm links, 0.43 mm tief
 Streuwert 3.84, horizontal: 3.53, vertikal: 4.13

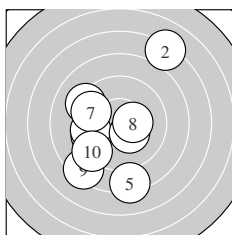
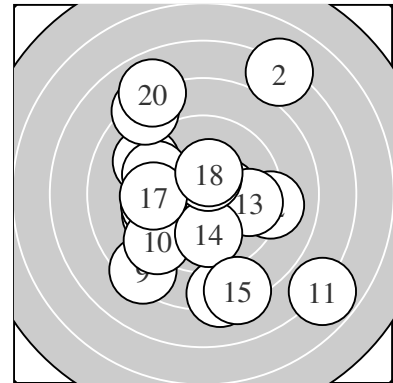

Serie 1:
 9.6 ← 7.1 ↗ 9.6 ← 9.2 ↘ 8.3 ↓
 10.3 * 9.6 ↖ 10.4 * 8.4 ✓ 9.2 ✓
 beste Teiler 147.2 (8.) 154.8 (6.) 332.5 (3.)
 Trefferlage 1.16 mm links, 0.63 mm tief
 Streuwert 3.65, horizontal: 3.12, vertikal: 4.11

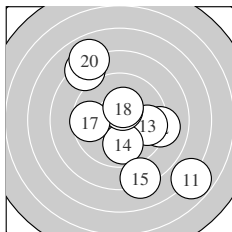

Serie 2:
 6.8 ↘ 9.1 → 9.7 → 9.9 ↓ 8.2 ↓
 10.5 * 9.6 ← 10.4 * 8.3 ↖ 7.9 ↖
 beste Teiler 116.0 (16.) 147.2 (18.) 266.5 (14.)
 Trefferlage 0.84 mm rechts, 0.22 mm tief
 Streuwert 4.09, horizontal: 3.80, vertikal: 4.36

Unterschrift des Schützen

Ergebnis: **174.8** (166)
 Serien: 89.0 85.8
 Zähler: 2 7 8 2 0 1 0 0 0 0
 Innenzehner: 1
 weiteste: 1433 (14), 926 (4), 838 (12)
 beste Teiler 144.1 (1.) 245.2 (18.) 283.1 (19.)
 Trefferlage 0.08 mm rechts, 1.89 mm hoch
 Streuwert 4.25, horizontal: 4.71, vertikal: 3.74

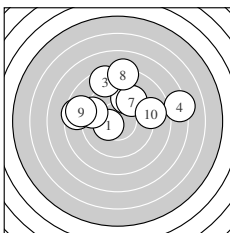
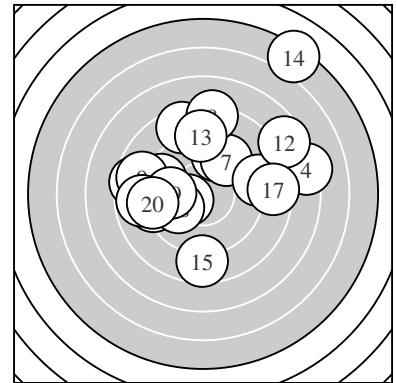

Serie 1:
 10.4 * 9.5 ↗ 8.5 ↖ 7.2 → 8.5 ←
 9.4 ← 9.5 ↗ 8.2 ↑ 8.8 ← 9.0 →
 beste Teiler 144.1 (1.) 353.4 (2.) 357.8 (7.)
 Trefferlage 0.01 mm links, 2.53 mm hoch
 Streuwert 3.64, horizontal: 4.63, vertikal: 2.26

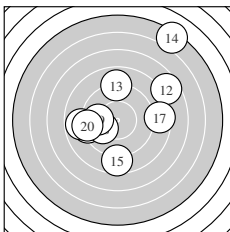

Serie 2:
 9.2 ← 7.6 ↗ 8.9 ↑ 5.2 ↗ 8.6 ↓
 8.8 ← 8.5 → 10.0 ← 9.8 ← 9.2 ←
 beste Teiler 245.2 (18.) 283.1 (19.) 445.8 (20.)
 Trefferlage 0.17 mm rechts, 1.25 mm hoch
 Streuwert 4.94, horizontal: 5.04, vertikal: 4.85

Unterschrift des Schützen