

Ergebnis: **198.7** (187)  
 Serien: 98.0 100.7  
 Zähler: 11 6 2 1 0 0 0 0 0 0  
 Innenzehner: 9  
 weiteste: 763 (2), 691 (13), 509 (3)  
 beste Teiler 42.9 (5.) 46.0 (11.) 73.4 (12.)  
 Trefferlage 0.94 mm rechts, 0.49 mm hoch  
 Streuwert 2.20, horizontal: 2.19, vertikal: 2.20

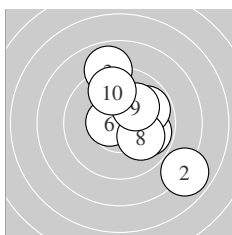

Serie 1:  
 9.8 ↘                      7.9 ↘                      8.9 ↑                      10.4 \*                      10.8 \*  
 10.6 \*                      9.8 ↗                      10.0 ↘                      10.1 ↗                      9.7 ↑  
 beste Teiler 42.9 (5.) 93.4 (6.) 145.1 (4.)  
 Trefferlage 1.35 mm rechts, 0.44 mm hoch  
 Streuwert 2.38, horizontal: 2.18, vertikal: 2.57

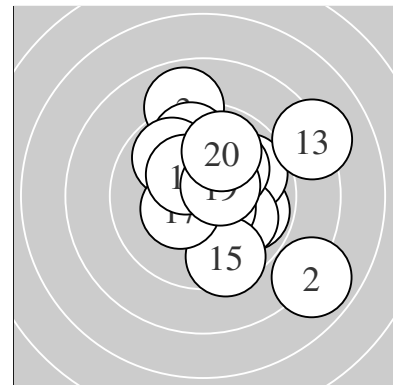
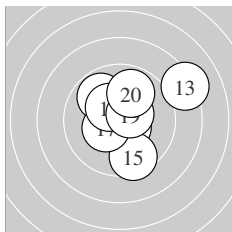

Serie 2:  
 10.8 \*                      10.7 \*                      8.2 ↗                      10.6 \*                      9.5 ↓  
 9.8 ↘                      10.4 \*                      10.3 \*                      10.5 \*                      9.9 ↑  
 beste Teiler 46.0 (11.) 73.4 (12.) 99.0 (14.)  
 Trefferlage 0.54 mm rechts, 0.53 mm hoch  
 Streuwert 2.08, horizontal: 2.24, vertikal: 1.91

Unterschrift des Schützen

Ergebnis: **195.7** (187)  
 Serien: 98.3 97.4  
 Zähler: 9 9 2 0 0 0 0 0 0 0  
 Innenzehner: 6  
 weiteste: 685 (3), 525 (14), 472 (8)  
 beste Teiler 53.7 (15.) 111.9 (20.) 118.5 (7.)  
 Trefferlage 0.14 mm rechts, 0.67 mm hoch  
 Streuwert 2.34, horizontal: 2.58, vertikal: 2.07

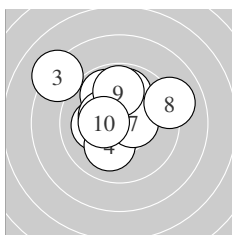
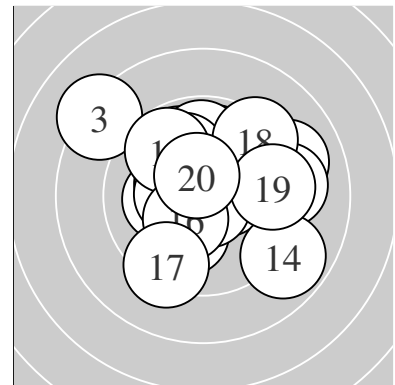

Serie 1:  
 9.9 ↖ 10.1 ← 8.2 ↘ 10.1 ✓ 10.3 \*  
 9.9 ↑ 10.5 \* 9.1 → 9.8 ↑ 10.4 \*  
 beste Teiler 118.5 (7.) 139.2 (10.) 151.7 (5.)  
 Trefferlage 0.63 mm links, 1.24 mm hoch  
 Streuwert 2.19, horizontal: 2.51, vertikal: 1.81

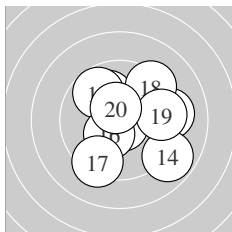

Serie 2:  
 10.0 ↖ 9.2 → 9.7 ↘ 8.9 ↘ 10.7 \*  
 10.3 \* 9.3 ✓ 9.3 ↗ 9.5 → 10.5 \*  
 beste Teiler 53.7 (15.) 111.9 (20.) 152.0 (16.)  
 Trefferlage 0.91 mm rechts, 0.11 mm hoch  
 Streuwert 2.40, horizontal: 2.54, vertikal: 2.24

Unterschrift des Schützen

Ergebnis: **177.2** (168)  
 Serien: 92.0 85.2  
 Zähler: 3 7 5 5 0 0 0 0 0 0  
 Innenzehner: 1  
 weiteste: 996 (20), 848 (7), 837 (13)  
 beste Teiler 174.4 (6.) 222.9 (3.) 250.5 (4.)  
 Trefferlage 2.16 mm rechts, 2.06 mm tief  
 Streuwert 3.59, horizontal: 4.43, vertikal: 2.49

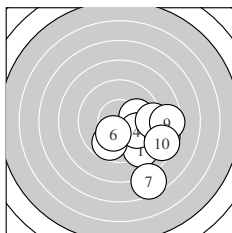
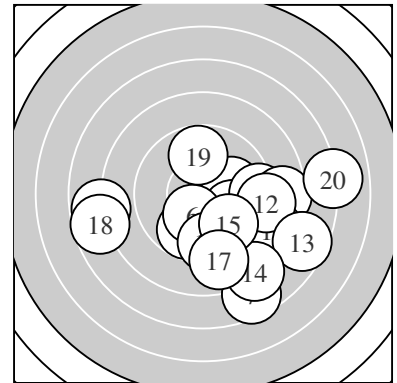

Serie 1:  
 9.2 ↘                      9.8 ↙                      10.1 →                      10.0 ↘                      8.7 →  
 10.3 \*                      7.6 ↘                      9.3 →                      8.5 →                      8.5 →  
 beste Teiler 174.4 (6.) 222.9 (3.) 250.5 (4.)  
 Trefferlage 2.97 mm rechts, 2.08 mm tief  
 Streuwert 2.44, horizontal: 2.51, vertikal: 2.37

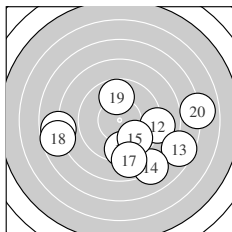

Serie 2:  
 9.5 ↓                      9.0 →                      7.6 ↘                      8.1 ↘                      9.8 ↘  
 7.8 ←                      8.9 ↓                      7.7 ←                      9.8 ↑                      7.0 →  
 beste Teiler 297.4 (19.) 298.6 (15.) 368.3 (11.)  
 Trefferlage 1.36 mm rechts, 2.04 mm tief  
 Streuwert 4.53, horizontal: 5.80, vertikal: 2.73

Unterschrift des Schützen

Ergebnis: **189.3** (180)  
 Serien: 92.1 97.2  
 Zähler: 5 10 5 0 0 0 0 0 0 0  
 Innenzehner: 4  
 weiteste: 715 (5), 678 (4), 640 (10)  
 beste Teiler 55.0 (13.) 163.2 (1.) 167.9 (20.)  
 Trefferlage 0.71 mm rechts, 0.56 mm tief  
 Streuwert 2.92, horizontal: 3.17, vertikal: 2.66

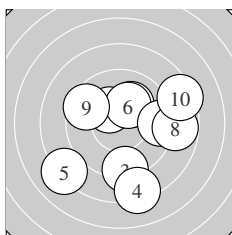
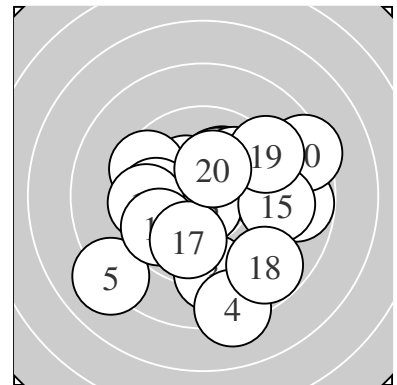

Serie 1:  
 10.3 \*                      10.1 ↗                      9.1 ↓                      8.2 ↓                      8.1 ↙  
 10.2 \*                      9.4 →                      8.8 →                      9.5 ↖                      8.4 →  
 beste Teiler 163.2 (1.) 192.7 (6.) 213.1 (2.)  
 Trefferlage 0.98 mm rechts, 0.72 mm tief  
 Streuwert 3.44, horizontal: 3.59, vertikal: 3.28

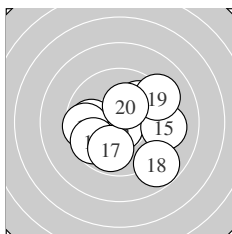

Serie 2:  
 9.9 ←                      9.9 ↗                      10.7 \*                      9.6 ←                      9.2 →  
 9.7 ↙                      9.9 ↓                      8.8 ↘                      9.2 ↗                      10.3 \*  
 beste Teiler 55.0 (13.) 167.9 (20.) 255.9 (12.)  
 Trefferlage 0.45 mm rechts, 0.40 mm tief  
 Streuwert 2.47, horizontal: 2.84, vertikal: 2.03

Unterschrift des Schützen

Ergebnis: **197.3** (188)  
 Serien: 98.8 98.5  
 Zähler: 9 10 1 0 0 0 0 0 0 0  
 Innenzehner: 8  
 weiteste: 594 (8), 480 (18), 448 (3)  
 beste Teiler 63.5 (15.) 123.6 (7.) 152.2 (10.)  
 Trefferlage 1.22 mm links, 1.20 mm hoch  
 Streuwert 1.83, horizontal: 1.93, vertikal: 1.72

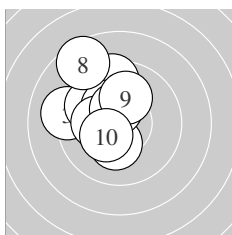
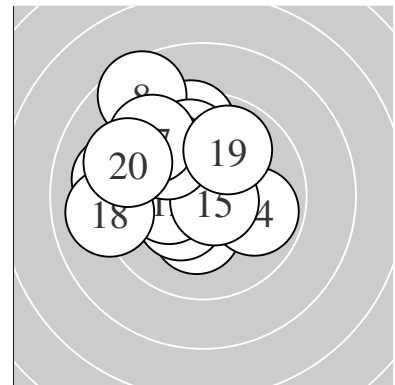

Serie 1:  
 9.5 ↑                      10.3 \*                      9.2 ←                      9.8 ↘                      10.3 \*  
 10.2 \*                      10.5 \*                      8.6 ↘                      10.1 ↑                      10.3 \*  
 beste Teiler 123.6 (7.) 152.2 (10.) 172.4 (5.)  
 Trefferlage 1.46 mm links, 1.30 mm hoch  
 Streuwert 1.77, horizontal: 1.49, vertikal: 2.02

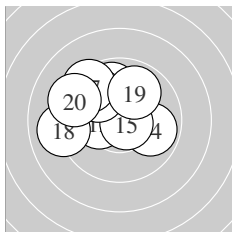

Serie 2:  
 10.2 \*                      10.3 \*                      9.9 ↑                      9.9 →                      10.7 \*  
 9.9 ↘                      9.4 ↘                      9.0 ←                      9.9 ↗                      9.3 ↘  
 beste Teiler 63.5 (15.) 173.0 (12.) 184.3 (11.)  
 Trefferlage 0.99 mm links, 1.11 mm hoch  
 Streuwert 1.96, horizontal: 2.35, vertikal: 1.47

Unterschrift des Schützen

Ergebnis: **174.3** (166)  
 Serien: 88.0 86.3  
 Zähler: 1 7 9 3 0 0 0 0 0 0  
 Innenzehner: 0  
 weiteste: 912 (15), 880 (19), 841 (20)  
 beste Teiler 204.4 (1.) 298.3 (11.) 333.7 (13.)  
 Trefferlage 0.49 mm rechts, 0.15 mm tief  
 Streuwert 4.27, horizontal: 5.32, vertikal: 2.86

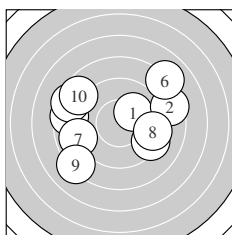
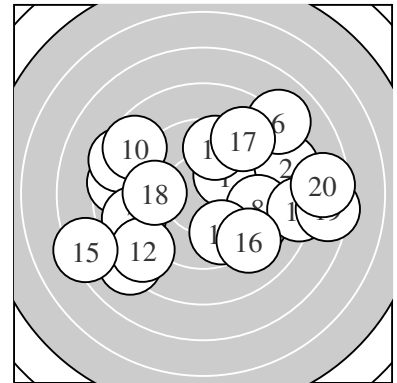

Serie 1:  
 10.1 ↗                      8.5 →                      9.3 ↘                      8.6 ←                      8.5 ↖  
 8.0 ↗                      8.9 ←                      9.4 →                      8.1 ↘                      8.6 ↖  
 beste Teiler 204.4 (1.) 397.7 (8.) 418.5 (3.)  
 Trefferlage 0.62 mm links, 0.51 mm hoch  
 Streuwert 4.12, horizontal: 5.05, vertikal: 2.91

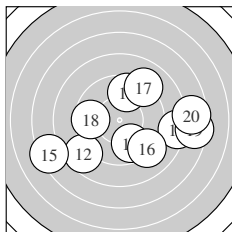

Serie 2:  
 9.8 ↘                      8.6 ↙                      9.6 ↑                      8.2 →                      7.3 ←  
 9.1 ↘                      9.1 ↗                      9.6 ←                      7.4 →                      7.6 →  
 beste Teiler 298.3 (11.) 333.7 (13.) 339.0 (18.)  
 Trefferlage 1.61 mm rechts, 0.81 mm tief  
 Streuwert 4.43, horizontal: 5.62, vertikal: 2.79

Unterschrift des Schützen

Ergebnis: **191.5** (181)  
 Serien: 95.9 95.6  
 Zähler: 5 11 4 0 0 0 0 0 0 0  
 Innenzehner: 3  
 weiteste: 612 (9), 580 (3), 562 (20)  
 beste Teiler 130.1 (10.) 164.5 (14.) 200.3 (1.)  
 Trefferlage 0.13 mm rechts, 1.64 mm tief  
 Streuwert 2.43, horizontal: 2.42, vertikal: 2.44

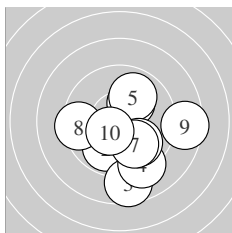
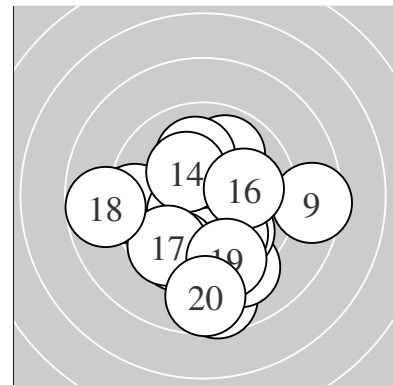

Serie 1:  
 10.2 \*                      9.9 ↙                      8.6 ↓                      9.2 ↘                      9.9 ↗  
 9.9 ↘                      9.9 ↘                      9.4 ←                      8.5 →                      10.4 \*  
 beste Teiler 130.1 (10.) 200.3 (1.) 255.7 (7.)  
 Trefferlage 0.85 mm rechts, 1.41 mm tief  
 Streuwert 2.50, horizontal: 2.58, vertikal: 2.43

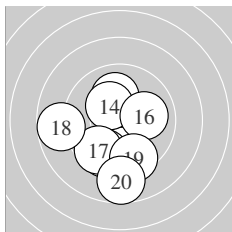

Serie 2:  
 10.1 ↑                      9.8 ↓                      9.3 ↓                      10.3 \*                      9.6 ↙  
 10.0 →                      9.6 ↙                      8.8 ←                      9.4 ↘                      8.7 ↓  
 beste Teiler 164.5 (14.) 224.1 (11.) 232.6 (16.)  
 Trefferlage 0.58 mm links, 1.88 mm tief  
 Streuwert 2.36, horizontal: 2.13, vertikal: 2.57

Unterschrift des Schützen

Ergebnis: **201.0** (193)  
 Serien: 99.4 101.6  
 Zähler: 14 5 1 0 0 0 0 0 0 0  
 Innenzehner: 9  
 weiteste: 521 (9), 458 (6), 358 (1)  
 beste Teiler 31.4 (5.) 60.8 (17.) 78.7 (8.)  
 Trefferlage 0.18 mm links, 0.34 mm hoch  
 Streuwert 1.84, horizontal: 2.36, vertikal: 1.11

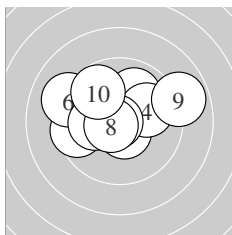
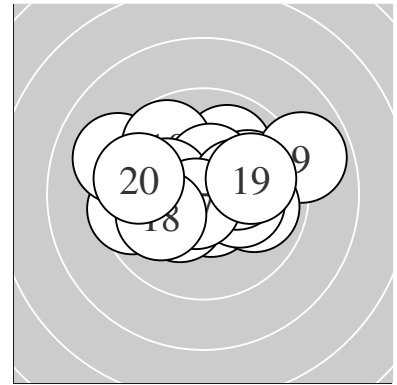

Serie 1:  
 9.5 ←                      10.6 \*                      10.0 ↗                      10.0 →                      10.8 \*  
 9.1 ↖                      10.1 ←                      10.6 \*                      8.9 →                      9.8 ↘  
 beste Teiler 31.4 (5.) 78.7 (8.) 96.6 (2.)  
 Trefferlage 0.38 mm links, 0.69 mm hoch  
 Streuwert 2.13, horizontal: 2.73, vertikal: 1.27

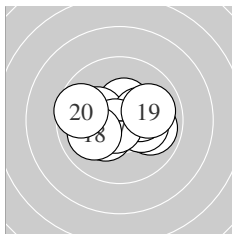

Serie 2:  
 9.9 →                      10.4 \*                      10.2 \*                      10.3 \*                      10.2 \*  
 10.3 \*                      10.7 \*                      10.0 ←                      10.0 →                      9.6 ←  
 beste Teiler 60.8 (17.) 129.1 (12.) 161.9 (14.)  
 Trefferlage 0.01 mm rechts, 0.00 mm  
 Streuwert 1.57, horizontal: 2.05, vertikal: 0.84

Unterschrift des Schützen



Ergebnis: **194.8** (185)  
 Serien: 99.0 95.8  
 Zähler: 7 11 2 0 0 0 0 0 0 0  
 Innenzehner: 5  
 weiteste: 727 (15), 523 (16), 492 (10)  
 beste Teiler 7.6 (19.) 72.0 (9.) 130.0 (3.)  
 Trefferlage 0.40 mm links, 0.11 mm tief  
 Streuwert 2.47, horizontal: 2.57, vertikal: 2.36

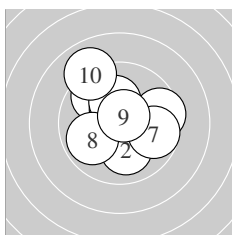
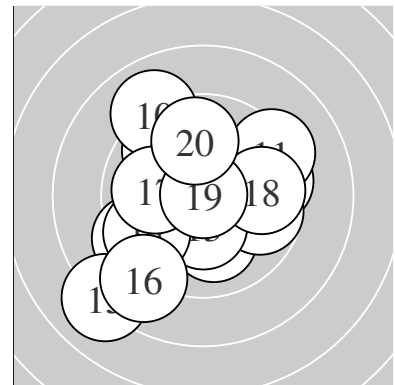

Serie 1:  
 9.7 ↘                      10.1 ↓                      10.4 \*                      10.2 \*                      9.8 →  
 9.5 →                      9.7 →                      9.9 ↙                      10.7 \*                      9.0 ↖  
 beste Teiler 72.0 (9.) 130.0 (3.) 190.2 (4.)  
 Trefferlage 0.27 mm rechts, 0.70 mm hoch  
 Streuwert 2.06, horizontal: 2.23, vertikal: 1.87

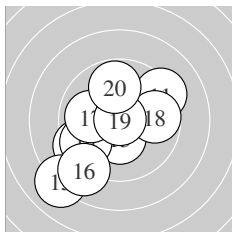

Serie 2:  
 9.3 ↗                      9.3 ↙                      10.3 \*                      9.6 ↙                      8.0 ↙  
 8.9 ↙                      10.0 ←                      9.7 →                      10.9 \*                      9.8 ↑  
 beste Teiler 7.6 (19.) 154.0 (13.) 248.9 (17.)  
 Trefferlage 1.07 mm links, 0.93 mm tief  
 Streuwert 2.71, horizontal: 2.82, vertikal: 2.59

Unterschrift des Schützen

Ergebnis: **192.1** (185)  
 Serien: 94.4 97.7  
 Zähler: 10 6 3 1 0 0 0 0 0 0  
 Innenzehner: 6  
 weiteste: 819 (9), 696 (11), 600 (8)  
 beste Teiler 89.2 (12.) 94.6 (10.) 126.5 (17.)  
 Trefferlage 0.36 mm links, 0.13 mm hoch  
 Streuwert 2.86, horizontal: 3.06, vertikal: 2.64

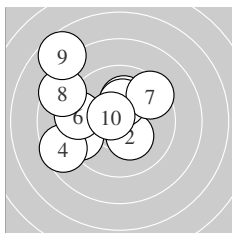
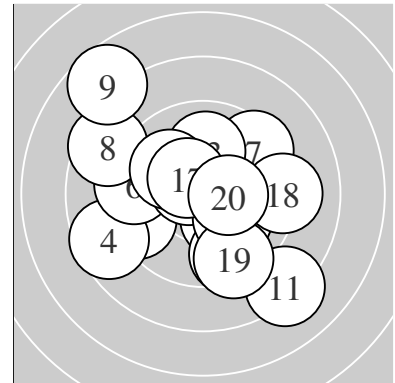

Serie 1:  
 10.1 ↑                      10.3 \*                      9.4 ←                      8.6 ←                      10.3 \*  
 9.4 ←                      9.4 ↗                      8.6 ↖                      7.7 ↘                      10.6 \*  
 beste Teiler 94.6 (10.) 169.7 (2.) 174.1 (5.)  
 Trefferlage 2.00 mm links, 1.06 mm hoch  
 Streuwert 2.82, horizontal: 3.08, vertikal: 2.53

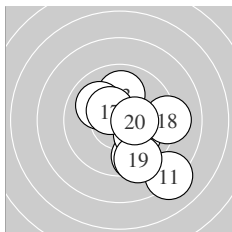

Serie 2:  
 8.2 ↘                      10.6 \*                      10.0 ↑                      10.0 ↖                      9.5 ↓  
 10.1 ↘                      10.4 \*                      9.2 →                      9.3 ↓                      10.4 \*  
 beste Teiler 89.2 (12.) 126.5 (17.) 142.1 (20.)  
 Trefferlage 1.26 mm rechts, 0.80 mm tief  
 Streuwert 2.31, horizontal: 2.10, vertikal: 2.51

Unterschrift des Schützen

Ergebnis: **197.1** (187)  
 Serien: 97.7 99.4  
 Zähler: 10 7 3 0 0 0 0 0 0 0  
 Innenzehner: 7  
 weiteste: 591 (3), 550 (18), 533 (6)  
 beste Teiler 2.8 (8.) 87.8 (16.) 107.5 (14.)  
 Trefferlage 0.58 mm links, 1.02 mm hoch  
 Streuwert 2.11, horizontal: 2.50, vertikal: 1.65

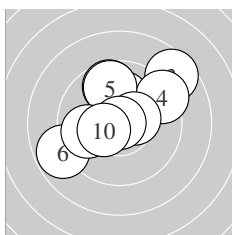
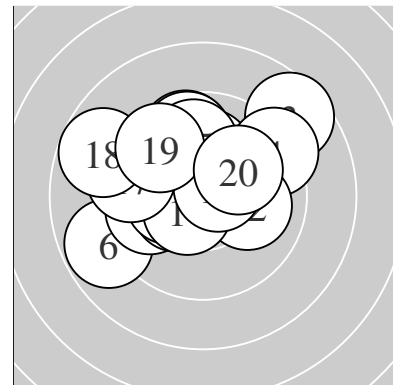

Serie 1:  
 9.7 ↑                      10.1 ↑                      8.6 ↗                      9.3 ↗                      9.7 ↑  
 8.8 ←                      10.4 \*                      10.9 \*                      9.8 ←                      10.4 \*  
 beste Teiler 2.8 (8.) 129.0 (7.) 144.6 (10.)  
 Trefferlage 0.10 mm links, 1.11 mm hoch  
 Streuwert 2.41, horizontal: 2.72, vertikal: 2.06

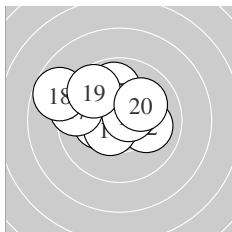

Serie 2:  
 10.2 \*                      10.0 →                      10.3 \*                      10.5 \*                      9.9 ↑  
 10.6 \*                      9.4 ←                      8.8 ↖                      9.6 ↘                      10.1 ↗  
 beste Teiler 87.8 (16.) 107.5 (14.) 169.1 (13.)  
 Trefferlage 1.07 mm links, 0.93 mm hoch  
 Streuwert 1.83, horizontal: 2.29, vertikal: 1.21

Unterschrift des Schützen

Ergebnis: **185.1** (177)  
 Serien: 90.8 94.3  
 Zähler: 3 12 4 1 0 0 0 0 0 0  
 Innenzehner: 0  
 weiteste: 768 (2), 693 (8), 654 (11)  
 beste Teiler 204.4 (13.) 205.1 (20.) 209.0 (1.)  
 Trefferlage 0.05 mm links, 0.12 mm tief  
 Streuwert 3.29, horizontal: 4.14, vertikal: 2.11

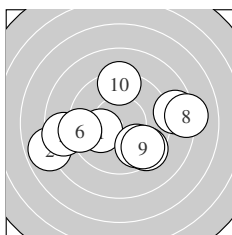
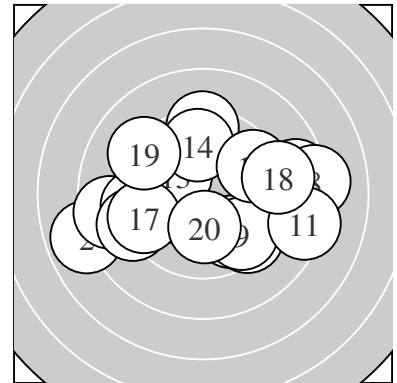

Serie 1:  
 10.1 ←                      7.9 ←                      8.6 ←                      9.4 ↘                      9.8 ↘  
 9.3 ←                      8.6 →                      8.2 →                      9.6 ↘                      9.3 ↑  
 beste Teiler 209.0 (1.) 293.0 (5.) 343.6 (9.)  
 Trefferlage 0.04 mm rechts, 0.67 mm tief  
 Streuwert 3.69, horizontal: 4.75, vertikal: 2.17

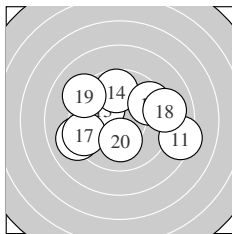

Serie 2:  
 8.3 →                      9.9 ↖                      10.1 ↖                      9.7 ↑                      9.1 ←  
 9.5 ↗                      9.4 ←                      9.0 →                      9.2 ↖                      10.1 ↓  
 beste Teiler 204.4 (13.) 205.1 (20.) 274.3 (12.)  
 Trefferlage 0.15 mm links, 0.41 mm hoch  
 Streuwert 2.97, horizontal: 3.69, vertikal: 2.00

Unterschrift des Schützen

Ergebnis: **198.5** (190)  
 Serien: 98.5 100.0  
 Zähler: 11 8 1 0 0 0 0 0 0 0  
 Innenzehner: 8  
 weiteste: 513 (15), 452 (20), 419 (5)  
 beste Teiler 36.0 (19.) 73.6 (16.) 74.4 (13.)  
 Trefferlage 0.41 mm links, 0.80 mm tief  
 Streuwert 2.01, horizontal: 2.20, vertikal: 1.80

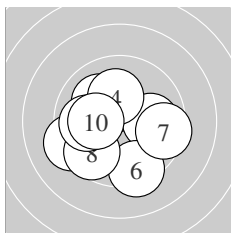
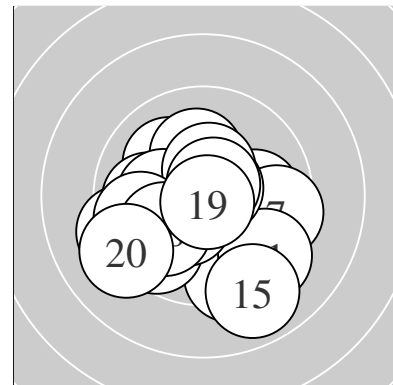

Serie 1:  
 10.4 \*                      10.1 ↘                      10.0 →                      10.2 \*                      9.3 ←  
 9.3 ↓                      9.5 →                      9.6 ↙                      9.9 ←                      10.2 \*  
 beste Teiler 141.3 (1.) 190.0 (10.) 196.6 (4.)  
 Trefferlage 0.58 mm links, 0.42 mm tief  
 Streuwert 2.11, horizontal: 2.35, vertikal: 1.82

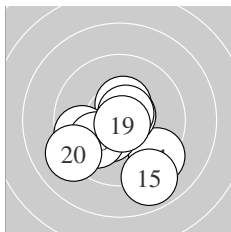

Serie 2:  
 9.3 ↘                      10.4 \*                      10.7 \*                      10.4 \*                      8.9 ↓  
 10.7 \*                      9.7 ←                      10.0 ↙                      10.8 \*                      9.1 ←  
 beste Teiler 36.0 (19.) 73.6 (16.) 74.4 (13.)  
 Trefferlage 0.24 mm links, 1.19 mm tief  
 Streuwert 1.97, horizontal: 2.14, vertikal: 1.79

Unterschrift des Schützen

Ergebnis: **186.6** (177)  
 Serien: 98.6 88.0  
 Zähler: 5 10 3 1 1 0 0 0 0 0  
 Innenzehner: 5  
 weiteste: 1033 (11), 903 (17), 596 (12)  
 beste Teiler 83.2 (2.) 107.3 (7.) 120.7 (6.)  
 Trefferlage 0.48 mm rechts, 0.26 mm hoch  
 Streuwert 3.39, horizontal: 3.75, vertikal: 2.97

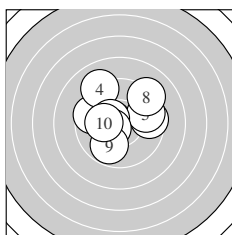
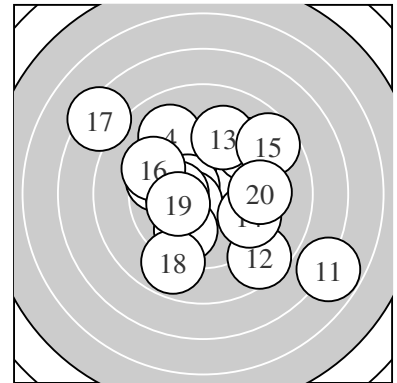

Serie 1:  
 9.5 → 10.6 \* 9.6 ↖ 9.1 ↙ 9.6 →  
 10.5 \* 10.5 \* 9.2 ↗ 9.8 ↓ 10.2 \*  
 beste Teiler 83.2 (2.) 107.3 (7.) 120.7 (6.)  
 Trefferlage 0.16 mm links, 0.75 mm hoch  
 Streuwert 2.17, horizontal: 2.47, vertikal: 1.83

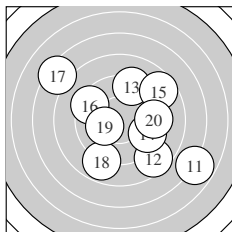

Serie 2:  
 6.8 ↘ 8.6 ↘ 9.3 ↑ 9.5 ↘ 8.7 ↗  
 9.4 ↖ 7.3 ↖ 8.9 ↓ 10.2 \* 9.3 →  
 beste Teiler 189.7 (19.) 361.8 (14.) 394.0 (16.)  
 Trefferlage 1.14 mm rechts, 0.22 mm tief  
 Streuwert 4.33, horizontal: 4.77, vertikal: 3.84

Unterschrift des Schützen

Ergebnis: **187.1** (178)  
 Serien: 91.2 95.9  
 Zähler: 6 6 8 0 0 0 0 0 0 0  
 Innenzehner: 4  
 weiteste: 688 (16), 661 (3), 660 (14)  
 beste Teiler 90.7 (12.) 90.9 (9.) 133.2 (13.)  
 Trefferlage 1.39 mm links, 1.96 mm hoch  
 Streuwert 2.74, horizontal: 3.28, vertikal: 2.06

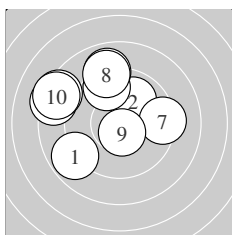
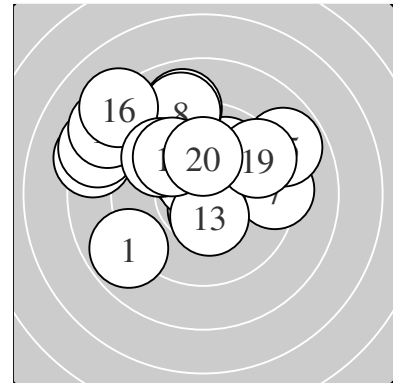

Serie 1:  
 8.9 ↙ 10.0 ↗ 8.3 ↖ 8.9 ↑ 9.5 ↑  
 8.4 ↘ 9.3 → 9.0 ↑ 10.6 \* 8.3 ↖  
 beste Teiler 90.9 (9.) 249.7 (2.) 365.3 (5.)  
 Trefferlage 2.04 mm links, 1.88 mm hoch  
 Streuwert 3.02, horizontal: 3.48, vertikal: 2.49

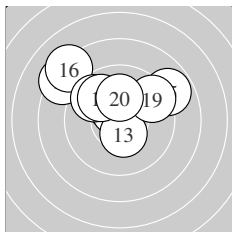

Serie 2:  
 10.4 \* 10.6 \* 10.4 \* 8.3 ↖ 8.8 ↗  
 8.2 ↘ 9.7 ↖ 9.9 ↖ 9.5 ↗ 10.1 ↑  
 beste Teiler 90.7 (12.) 133.2 (13.) 140.8 (11.)  
 Trefferlage 0.75 mm links, 2.04 mm hoch  
 Streuwert 2.50, horizontal: 3.12, vertikal: 1.66

Unterschrift des Schützen

Ergebnis: **199.2** (188)  
 Serien: 98.0 101.2  
 Zähler: 9 10 1 0 0 0 0 0 0 0  
 Innenzehner: 7  
 weiteste: 537 (9), 406 (10), 357 (3)  
 beste Teiler 36.6 (18.) 53.4 (7.) 75.9 (2.)  
 Trefferlage 0.47 mm rechts, 0.13 mm hoch  
 Streuwert 2.01, horizontal: 2.17, vertikal: 1.83

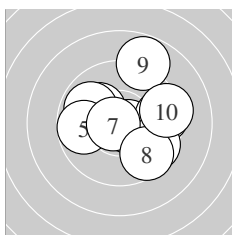
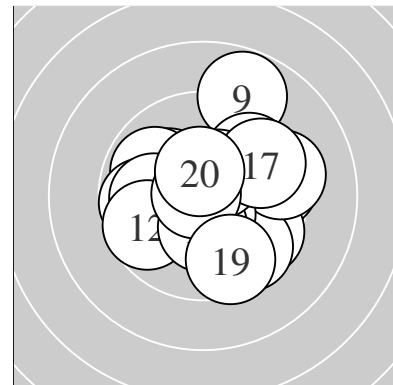

Serie 1:  
 10.1 ↘                      10.7 \*                      9.5 →                      9.9 ↖                      9.8 ←  
 9.6 ↘                      10.7 \*                      9.6 ↘                      8.8 ↑                      9.3 →  
 beste Teiler 53.4 (7.) 75.9 (2.) 207.7 (1.)  
 Trefferlage 0.75 mm rechts, 0.40 mm hoch  
 Streuwert 2.30, horizontal: 2.53, vertikal: 2.04

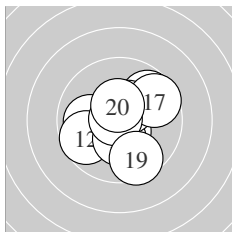

Serie 2:  
 10.0 ←                      9.7 ↙                      10.6 \*                      9.7 ↗                      10.3 \*  
 10.4 \*                      9.6 ↗                      10.8 \*                      9.6 ↘                      10.5 \*  
 beste Teiler 36.6 (18.) 99.9 (13.) 124.1 (20.)  
 Trefferlage 0.19 mm rechts, 0.12 mm tief  
 Streuwert 1.74, horizontal: 1.83, vertikal: 1.65

Unterschrift des Schützen



Ergebnis: **201.7** (193)  
 Serien: 101.4 100.3  
 Zähler: 13 7 0 0 0 0 0 0 0 0  
 Innenzehner: 9  
 weiteste: 439 (8), 396 (9), 376 (18)  
 beste Teiler 50.3 (5.) 58.3 (13.) 70.7 (4.)  
 Trefferlage 0.05 mm links, 0.18 mm hoch  
 Streuwert 1.81, horizontal: 2.05, vertikal: 1.55

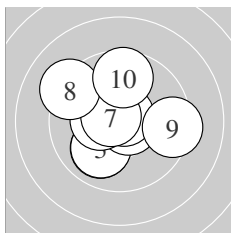
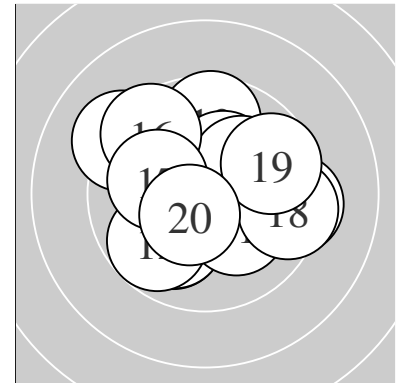

Serie 1:  
 10.0 ↙                      10.5 \*                      10.0 ↙                      10.7 \*                      10.8 \*  
 10.4 \*                      10.7 \*                      9.2 ↘                      9.4 →                      9.7 ↑  
 beste Teiler 50.3 (5.) 70.7 (4.) 73.4 (7.)  
 Trefferlage 0.40 mm links, 0.09 mm hoch  
 Streuwert 1.83, horizontal: 1.97, vertikal: 1.67

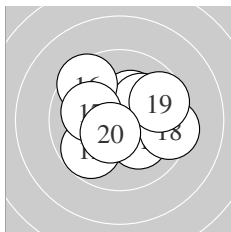

Serie 2:  
 10.2 \*                      9.8 ↙                      10.7 \*                      10.3 \*                      10.1 ↗  
 9.5 ↘                      10.1 ←                      9.4 →                      9.7 →                      10.5 \*  
 beste Teiler 58.3 (13.) 116.6 (20.) 166.9 (14.)  
 Trefferlage 0.30 mm rechts, 0.28 mm hoch  
 Streuwert 1.86, horizontal: 2.16, vertikal: 1.50

Unterschrift des Schützen

Ergebnis: **193.1** (183)  
 Serien: 97.3 95.8  
 Zähler: 7 9 4 0 0 0 0 0 0 0  
 Innenzehner: 6  
 weiteste: 517 (11), 510 (17), 506 (1)  
 beste Teiler 76.6 (3.) 114.5 (6.) 139.7 (20.)  
 Trefferlage 0.96 mm rechts, 1.08 mm hoch  
 Streuwert 2.39, horizontal: 2.98, vertikal: 1.59

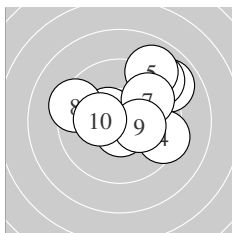
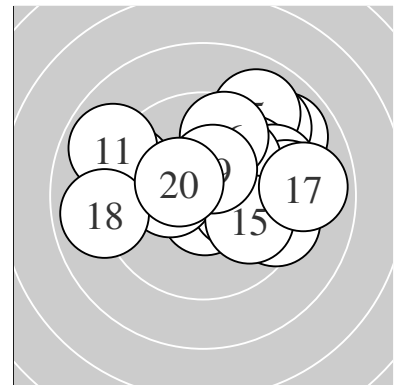

Serie 1:  
 8.9 ↗ 9.1 ↗ 10.6 \* 9.4 ↘ 9.0 ↗  
 10.5 \* 9.8 ↗ 9.4 ↖ 10.3 \* 10.3 \*  
 beste Teiler 76.6 (3.) 114.5 (6.) 166.6 (10.)  
 Trefferlage 1.14 mm rechts, 1.20 mm hoch  
 Streuwert 2.27, horizontal: 2.60, vertikal: 1.88

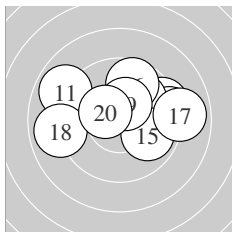

Serie 2:  
 8.9 ↖ 9.4 → 9.3 → 10.0 ↗ 9.9 ↘  
 9.7 ↑ 8.9 → 8.9 ← 10.4 \* 10.4 \*  
 beste Teiler 139.7 (20.) 144.5 (19.) 246.0 (14.)  
 Trefferlage 0.77 mm rechts, 0.96 mm hoch  
 Streuwert 2.62, horizontal: 3.45, vertikal: 1.33

Unterschrift des Schützen

Ergebnis: **189.3** (181)  
 Serien: 93.3 96.0  
 Zähler: 6 10 3 1 0 0 0 0 0 0  
 Innenzehner: 2  
 weiteste: 754 (10), 708 (12), 610 (5)  
 beste Teiler 80.5 (15.) 170.2 (3.) 203.4 (8.)  
 Trefferlage 1.68 mm rechts, 0.66 mm tief  
 Streuwert 2.68, horizontal: 2.88, vertikal: 2.47

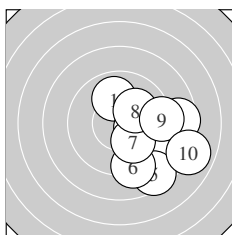
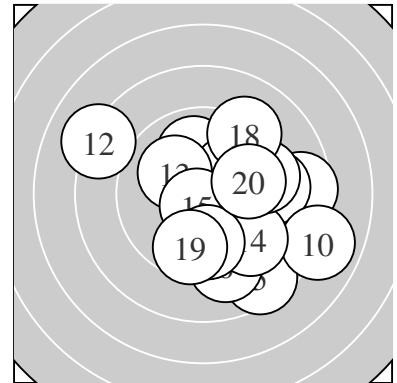

Serie 1:  
 9.9 ↑                      9.5 ↘                      10.3 \*                      8.6 →                      8.5 ↘  
 9.2 ↓                      10.1 ↘                      10.1 ↗                      9.2 →                      7.9 ↘  
 beste Teiler 170.2 (3.) 203.4 (8.) 224.0 (7.)  
 Trefferlage 2.88 mm rechts, 1.23 mm tief  
 Streuwert 2.37, horizontal: 2.30, vertikal: 2.45

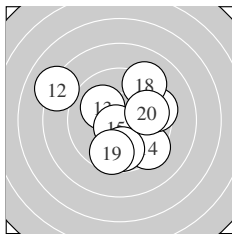

Serie 2:  
 10.0 ↘                      8.1 ↖                      10.1 ↖                      9.4 ↘                      10.6 \*  
 9.4 →                      9.8 ↓                      9.2 ↗                      9.6 ↓                      9.8 →  
 beste Teiler 80.5 (15.) 214.2 (13.) 240.5 (11.)  
 Trefferlage 0.47 mm rechts, 0.10 mm tief  
 Streuwert 2.75, horizontal: 2.99, vertikal: 2.48

Unterschrift des Schützen

Ergebnis: **188.4** (180)  
 Serien: 95.7 92.7  
 Zähler: 6 9 4 1 0 0 0 0 0 0  
 Innenzehner: 3  
 weiteste: 816 (18), 691 (19), 658 (11)  
 beste Teiler 115.8 (2.) 130.2 (12.) 149.9 (13.)  
 Trefferlage 0.59 mm links, 0.60 mm hoch  
 Streuwert 3.02, horizontal: 2.87, vertikal: 3.17

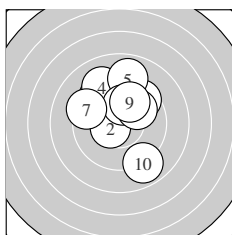
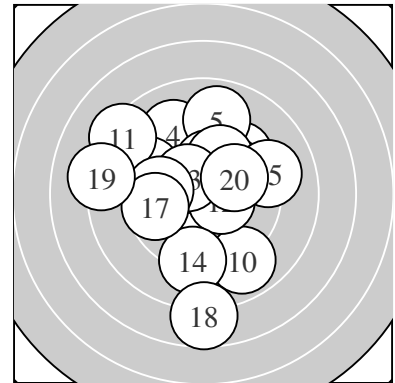

Serie 1:  
 9.4 ↘                      10.5 \*                      9.5 ↗                      9.2 ↖                      8.9 ↑  
 10.1 ↑                      9.3 ↙                      10.0 ↘                      9.9 ↗                      8.9 ↘  
 beste Teiler 115.8 (2.) 205.8 (6.) 248.4 (8.)  
 Trefferlage 0.03 mm rechts, 1.72 mm hoch  
 Streuwert 2.41, horizontal: 2.17, vertikal: 2.62

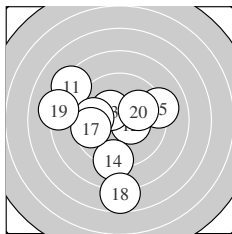

Serie 2:  
 8.3 ↘                      10.4 \*                      10.4 \*                      9.2 ↓                      9.1 →  
 9.8 ←                      9.6 ←                      7.7 ↓                      8.2 ←                      10.0 →  
 beste Teiler 130.2 (12.) 149.9 (13.) 236.6 (20.)  
 Trefferlage 1.23 mm links, 0.51 mm tief  
 Streuwert 3.42, horizontal: 3.43, vertikal: 3.41

Unterschrift des Schützen

Ergebnis: **183.2** (175)  
 Serien: 95.4 87.8  
 Zähler: 5 9 2 4 0 0 0 0 0 0  
 Innenzehner: 4  
 weiteste: 942 (18), 849 (8), 819 (16)  
 beste Teiler 113.9 (4.) 145.4 (3.) 166.7 (2.)  
 Trefferlage 0.97 mm links, 1.45 mm hoch  
 Streuwert 3.49, horizontal: 3.85, vertikal: 3.08

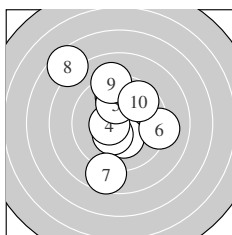
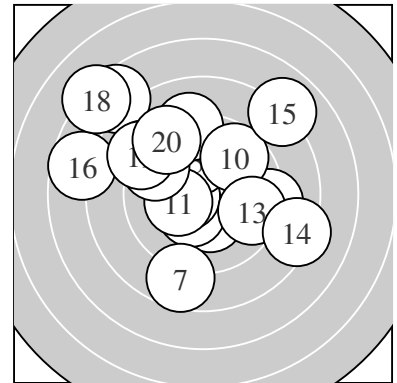

Serie 1:  
 9.8 ↑                      10.3 \*                      10.4 \*                      10.5 \*                      10.1 ↑  
 9.2 →                      8.7 ↓                      7.6 ↖                      9.1 ↑                      9.7 ↗  
 beste Teiler 113.9 (4.) 145.4 (3.) 166.7 (2.)  
 Trefferlage 0.39 mm links, 0.91 mm hoch  
 Streuwert 3.03, horizontal: 2.58, vertikal: 3.42

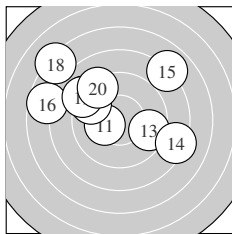

Serie 2:  
 10.3 \*                      9.1 ↖                      9.6 →                      8.3 →                      7.9 ↗  
 7.7 ←                      9.5 ↖                      7.2 ↖                      9.0 ↖                      9.2 ↖  
 beste Teiler 171.0 (11.) 342.4 (13.) 362.8 (17.)  
 Trefferlage 1.55 mm links, 1.99 mm hoch  
 Streuwert 3.98, horizontal: 4.89, vertikal: 2.78

Unterschrift des Schützen

Ergebnis: **198.8** (188)  
 Serien: 98.7 100.1  
 Zähler: 8 12 0 0 0 0 0 0 0 0  
 Innenzehner: 6  
 weiteste: 469 (4), 353 (15), 352 (17)  
 beste Teiler 93.1 (16.) 113.5 (3.) 119.8 (12.)  
 Trefferlage 0.08 mm rechts, 0.01 mm hoch  
 Streuwert 1.94, horizontal: 2.04, vertikal: 1.84

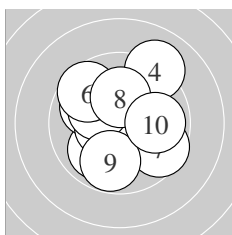
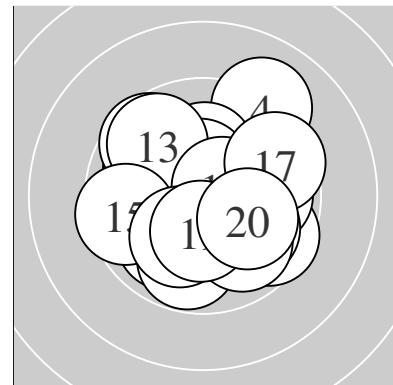

Serie 1:  
 9.9 ↙                      9.9 ↘                      10.5 \*                      9.1 ↗                      10.2 \*  
 9.6 ↘                      9.6 ↘                      10.2 \*                      9.8 ↓                      9.9 →  
 beste Teiler 113.5 (3.) 187.6 (5.) 192.1 (8.)  
 Trefferlage 0.13 mm links, 0.36 mm hoch  
 Streuwert 2.10, horizontal: 2.09, vertikal: 2.12

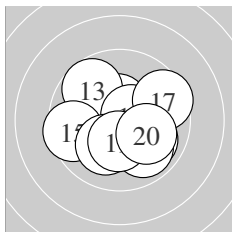

Serie 2:  
 9.9 ↘                      10.5 \*                      9.7 ↘                      9.9 ↘                      9.5 ←  
 10.6 \*                      9.5 →                      10.1 ↓                      10.3 \*                      10.1 ↘  
 beste Teiler 93.1 (16.) 119.8 (12.) 157.3 (19.)  
 Trefferlage 0.30 mm rechts, 0.33 mm tief  
 Streuwert 1.82, horizontal: 2.06, vertikal: 1.55

Unterschrift des Schützen

Ergebnis: **178.5** (169)  
 Serien: 84.9 93.6  
 Zähler: 4 8 6 1 0 0 0 0 1 0  
 Innenzehner: 4  
 weiteste: 2036 (3), 925 (1), 742 (14)  
 beste Teiler 68.3 (15.) 83.0 (18.) 90.0 (20.)  
 Trefferlage 1.91 mm rechts, 0.51 mm hoch  
 Streuwert 4.56, horizontal: 5.74, vertikal: 2.93

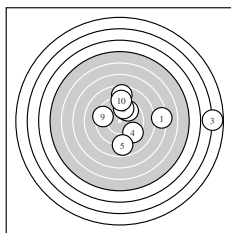
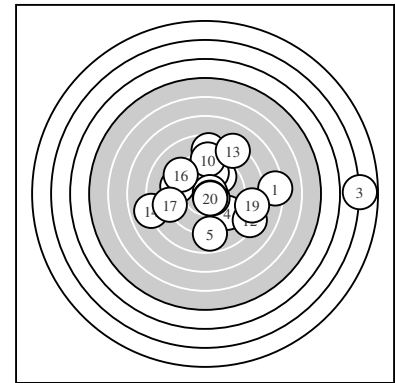

Serie 1:  
 7.3 →                      8.6 ↑                      2.8 →                      9.4 ↘                      8.9 ↓  
 9.8 ↗                      9.8 ↗                      9.8 ↑                      9.4 ←                      9.1 ↑  
 beste Teiler 281.3 (6.) 291.5 (8.) 294.8 (7.)  
 Trefferlage 3.44 mm rechts, 1.20 mm hoch  
 Streuwert 5.28, horizontal: 6.75, vertikal: 3.21

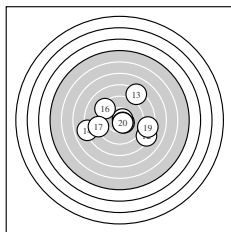

Serie 2:  
 10.5 \*                      8.2 ↘                      8.3 ↗                      8.0 ←                      10.7 \*  
 9.3 ↖                      9.0 ←                      10.6 \*                      8.4 →                      10.6 \*  
 beste Teiler 68.3 (15.) 83.0 (18.) 90.0 (20.)  
 Trefferlage 0.37 mm rechts, 0.18 mm tief  
 Streuwert 3.57, horizontal: 4.33, vertikal: 2.59

Unterschrift des Schützen

Ergebnis: **186.8** (178)  
 Serien: 92.2 94.6  
 Zähler: 8 5 4 3 0 0 0 0 0 0  
 Innenzehner: 4  
 weiteste: 932 (11), 898 (1), 771 (17)  
 beste Teiler 10.0 (16.) 56.0 (13.) 69.9 (15.)  
 Trefferlage 2.27 mm rechts, 0.97 mm tief  
 Streuwert 3.06, horizontal: 3.18, vertikal: 2.95

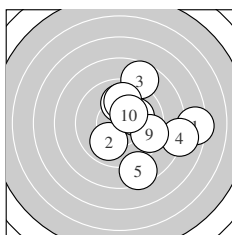
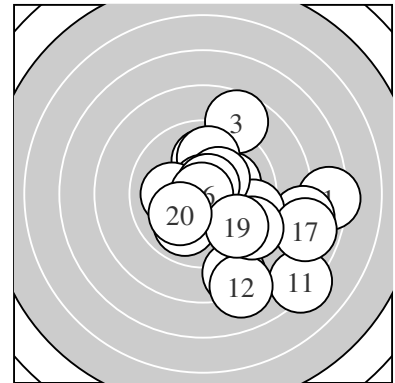

Serie 1:  
 7.4 →                      9.9 ↙                      8.7 ↗                      8.0 →                      8.5 ↓  
 10.0 ↑                      10.1 →                      9.9 ↑                      9.4 →                      10.3 \*  
 beste Teiler 154.8 (10.) 204.0 (7.) 237.0 (6.)  
 Trefferlage 2.63 mm rechts, 0.09 mm hoch  
 Streuwert 3.10, horizontal: 3.20, vertikal: 3.01

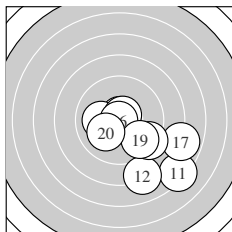

Serie 2:  
 7.2 ↘                      8.1 ↓                      10.7 \*                      10.1 ←                      10.7 \*  
 10.9 \*                      7.9 →                      9.3 ↘                      9.6 ↘                      10.1 ↙  
 beste Teiler 10.0 (16.) 56.0 (13.) 69.9 (15.)  
 Trefferlage 1.92 mm rechts, 2.03 mm tief  
 Streuwert 2.96, horizontal: 3.29, vertikal: 2.60

Unterschrift des Schützen



Ergebnis: **194.3** (185)  
 Serien: 98.1 96.2  
 Zähler: 7 11 2 0 0 0 0 0 0 0  
 Innenzehner: 5  
 weiteste: 681 (20), 586 (14), 488 (4)  
 beste Teiler 60.4 (1.) 82.8 (3.) 103.2 (7.)  
 Trefferlage 0.99 mm links, 1.84 mm hoch  
 Streuwert 2.00, horizontal: 2.41, vertikal: 1.48

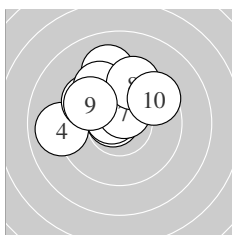
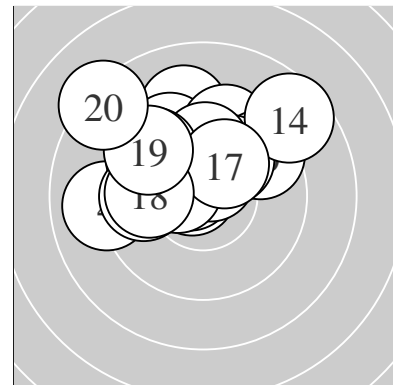

Serie 1:  
 10.7 \*                      9.2 ↑                      10.6 \*                      9.0 ←                      9.7 ↘  
 9.6 ↘                      10.5 \*                      9.5 ↑                      9.8 ↘                      9.5 ↗  
 beste Teiler 60.4 (1.) 82.8 (3.) 103.2 (7.)  
 Trefferlage 0.94 mm links, 1.74 mm hoch  
 Streuwert 1.86, horizontal: 2.16, vertikal: 1.51

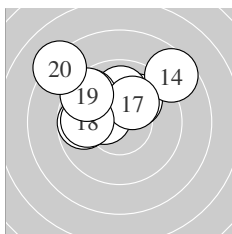

Serie 2:  
 10.4 \*                      10.0 ↗                      10.0 ↑                      8.6 ↗                      9.8 ←  
 9.6 ↘                      10.2 \*                      9.9 ←                      9.5 ↘                      8.2 ↘  
 beste Teiler 133.5 (11.) 194.6 (17.) 228.2 (12.)  
 Trefferlage 1.04 mm links, 1.94 mm hoch  
 Streuwert 2.23, horizontal: 2.76, vertikal: 1.53

Unterschrift des Schützen

Ergebnis: **189.6** (181)  
 Serien: 95.3 94.3  
 Zähler: 5 11 4 0 0 0 0 0 0 0  
 Innenzehner: 4  
 weiteste: 642 (17), 632 (18), 581 (2)  
 beste Teiler 68.8 (3.) 82.7 (7.) 122.6 (11.)  
 Trefferlage 0.15 mm links, 0.08 mm tief  
 Streuwert 2.90, horizontal: 3.46, vertikal: 2.22

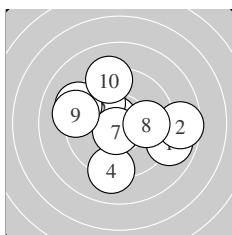
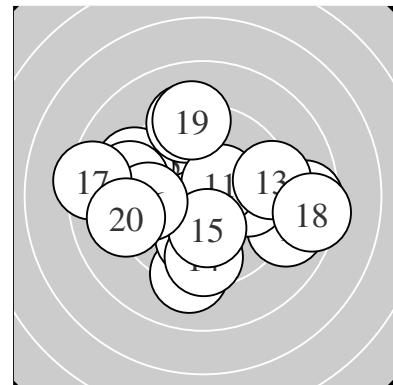

Serie 1:  
 8.9 →                      8.6 →                      10.7 \*                      9.1 ↓                      9.9 ↖  
 9.2 ↖                      10.6 \*                      9.9 →                      9.2 ↖                      9.2 ↑  
 beste Teiler 68.8 (3.) 82.7 (7.) 255.0 (5.)  
 Trefferlage 0.05 mm rechts, 0.17 mm hoch  
 Streuwert 2.88, horizontal: 3.35, vertikal: 2.32

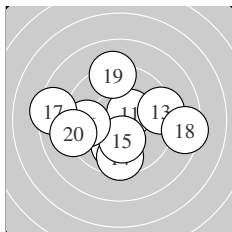

Serie 2:  
 10.5 \*                      10.0 ↓                      9.3 →                      9.5 ↓                      10.2 \*  
 9.7 ←                      8.4 ←                      8.4 →                      9.2 ↑                      9.1 ←  
 beste Teiler 122.6 (11.) 186.5 (15.) 244.1 (12.)  
 Trefferlage 0.36 mm links, 0.34 mm tief  
 Streuwert 3.06, horizontal: 3.73, vertikal: 2.21

Unterschrift des Schützen

Ergebnis: **193.3** (184)  
 Serien: 96.2 97.1  
 Zähler: 6 12 2 0 0 0 0 0 0 0  
 Innenzehner: 6  
 weiteste: 677 (9), 586 (19), 451 (2)  
 beste Teiler 76.6 (11.) 112.0 (7.) 139.0 (20.)  
 Trefferlage 0.79 mm rechts, 0.20 mm hoch  
 Streuwert 2.50, horizontal: 2.93, vertikal: 1.98

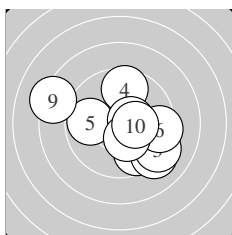
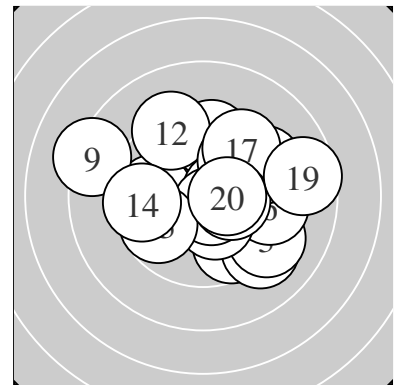

Serie 1:  
 9.7 ↘                      9.1 ↘                      9.2 ↘                      9.6 ↑                      9.8 ←  
 9.4 →                      10.5 \*                      10.3 \*                      8.2 ↖                      10.4 \*  
 beste Teiler 112.0 (7.) 150.8 (10.) 158.3 (8.)  
 Trefferlage 0.70 mm rechts, 0.45 mm tief  
 Streuwert 2.68, horizontal: 3.16, vertikal: 2.09

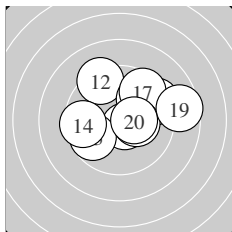

Serie 2:  
 10.6 \*                      9.3 ↖                      9.7 ↙                      9.5 ←                      9.4 ↗  
 9.8 ↗                      9.5 ↗                      10.3 \*                      8.6 →                      10.4 \*  
 beste Teiler 76.6 (11.) 139.0 (20.) 165.5 (18.)  
 Trefferlage 0.89 mm rechts, 0.85 mm hoch  
 Streuwert 2.35, horizontal: 2.85, vertikal: 1.70

Unterschrift des Schützen