

Ergebnis: **398.7** (380)
 Serien: 100.5 99.9 99.6 98.7
 Zähler: 21 18 1 0 0 0 0 0 0 0
 Innenzehner: 15
 weiteste: 554 (3), 434 (40), 426 (21)
 beste Teiler 64.1 (27.) 67.2 (30.) 86.3 (20.)
 Trefferlage 0.37 mm rechts, 0.20 mm tief
 Streuwert 1.91, horizontal: 2.09, vertikal: 1.70

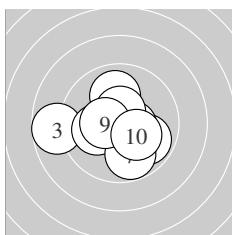

Serie 1:
 10.4 * 9.9 ↘ 8.7 ← 10.1 ← 10.5 *
 10.0 ↑ 9.8 ↓ 10.5 * 10.4 * 10.2 *
 beste Teiler 102.1 (8.) 106.9 (5.) 128.0 (9.)
 Trefferlage 0.21 mm links, 0.37 mm tief
 Streuwert 1.88, horizontal: 2.28, vertikal: 1.37

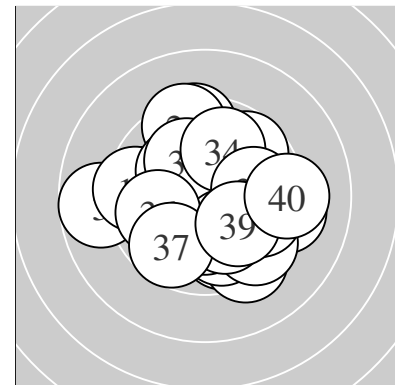
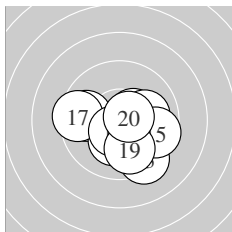

Serie 2:
 10.4 * 9.8 ← 9.3 ↘ 10.1 → 9.6 →
 10.2 * 9.5 ← 10.5 * 9.9 ↓ 10.6 *
 beste Teiler 86.3 (20.) 109.1 (18.) 132.0 (11.)
 Trefferlage 0.27 mm rechts, 0.77 mm tief
 Streuwert 1.86, horizontal: 2.22, vertikal: 1.41

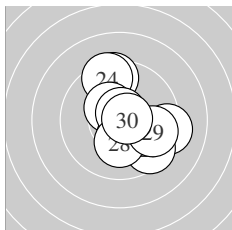

Serie 3:
 9.2 → 9.4 ↑ 9.5 ↘ 9.4 ↑ 10.4 *
 10.4 * 10.7 * 10.2 * 9.7 → 10.7 *
 beste Teiler 64.1 (27.) 67.2 (30.) 135.9 (26.)
 Trefferlage 0.82 mm rechts, 0.17 mm hoch
 Streuwert 1.99, horizontal: 1.80, vertikal: 2.17

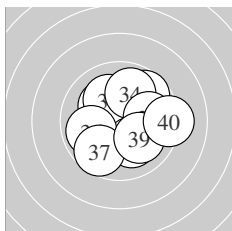

Serie 4:
 10.2 * 9.7 ↗ 10.1 ↖ 9.9 ↗ 10.1 ↓
 9.9 ← 9.7 ↙ 9.9 → 10.0 ↘ 9.2 →
 beste Teiler 195.2 (31.) 211.1 (33.) 215.8 (35.)
 Trefferlage 0.61 mm rechts, 0.13 mm hoch
 Streuwert 2.02, horizontal: 2.21, vertikal: 1.81

Unterschrift des Schützen

Ergebnis: **410.9** (393)
 Serien: 103.3 101.2 103.2 103.2
 Zähler: 33 7 0 0 0 0 0 0 0 0
 Innenzehner: 26
 weiteste: 497 (12), 396 (5), 369 (32)
 beste Teiler 11.1 (37.) 25.0 (2.) 36.3 (39.)
 Trefferlage 0.01 mm links, 0.58 mm hoch
 Streuwert 1.38, horizontal: 1.44, vertikal: 1.33

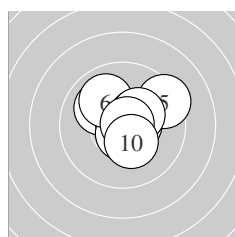
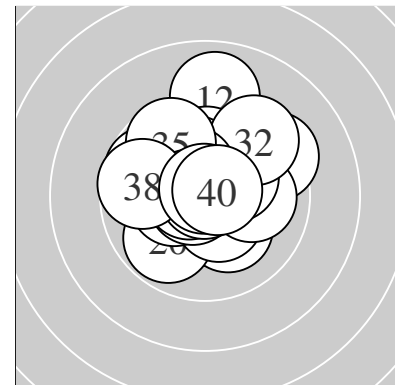

Serie 1:
 10.0 ↘ 10.9 * 10.7 * 10.5 * 9.4 ↗
 10.0 ↘ 10.4 * 10.3 * 10.8 * 10.3 *
 beste Teiler 25.0 (2.) 39.8 (9.) 71.0 (3.)
 Trefferlage 0.47 mm rechts, 0.54 mm hoch
 Streuwert 1.30, horizontal: 1.47, vertikal: 1.10

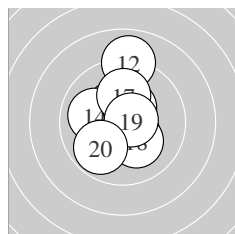

Serie 2:
 10.1 ↗ 9.0 ↑ 10.4 * 10.0 ← 10.5 *
 10.4 * 10.1 ↑ 10.2 * 10.7 * 9.8 ↙
 beste Teiler 74.2 (19.) 120.9 (15.) 133.7 (16.)
 Trefferlage 0.25 mm links, 0.44 mm hoch
 Streuwert 1.74, horizontal: 1.25, vertikal: 2.11

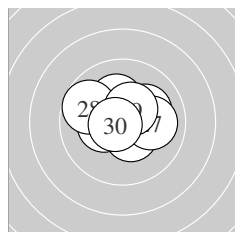

Serie 3:
 10.8 * 10.5 * 10.1 ↗ 10.5 * 10.3 *
 10.2 * 10.0 → 9.7 ↖ 10.4 * 10.7 *
 beste Teiler 41.4 (21.) 65.1 (30.) 110.0 (24.)
 Trefferlage 0.04 mm links, 0.38 mm hoch
 Streuwert 1.26, horizontal: 1.55, vertikal: 0.86

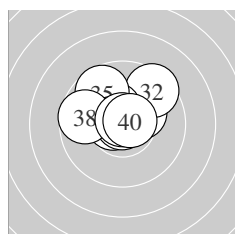

Serie 4:
 10.3 * 9.5 ↗ 10.6 * 10.4 * 9.7 ↖
 10.6 * 10.9 * 9.7 ← 10.8 * 10.7 *
 beste Teiler 11.1 (37.) 36.3 (39.) 67.5 (40.)
 Trefferlage 0.25 mm links, 0.96 mm hoch
 Streuwert 1.31, horizontal: 1.56, vertikal: 0.99

Unterschrift des Schützen

Meyton Elektronik

Ergebnis: **376.3** (357)
 Serien: 96.6 94.7 88.5 96.5
 Zähler: 14 14 8 3 1 0 0 0 0 0
 Innenzehner: 9
 weiteste: 1073 (24), 868 (23), 810 (15)
 beste Teiler 16.4 (1.) 51.6 (17.) 126.2 (3.)
 Trefferlage 0.40 mm links, 0.23 mm tief
 Streuwert 3.21, horizontal: 3.93, vertikal: 2.26

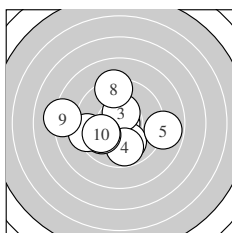
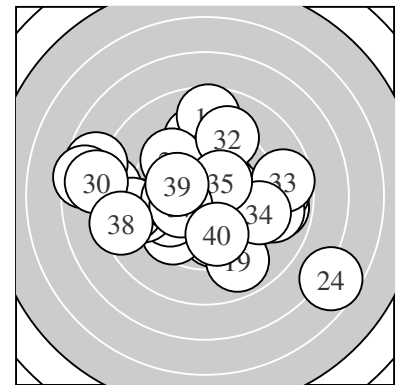

Serie 1:
 10.9 * 10.0 ↘ 10.4 * 9.8 ↓ 8.9 →
 9.9 ↙ 9.3 ← 9.3 ↑ 8.2 ← 9.9 ↙
 beste Teiler 16.4 (1.) 126.2 (3.) 237.4 (2.)
 Trefferlage 0.86 mm links, 0.36 mm tief
 Streuwert 2.65, horizontal: 3.18, vertikal: 1.98

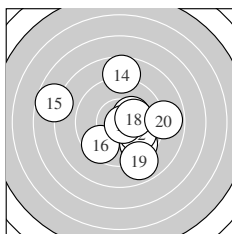

Serie 2:
 9.6 ↘ 10.0 ↘ 10.3 * 8.7 ↑ 7.7 ←
 9.6 ↙ 10.7 * 10.3 * 8.9 ↓ 8.9 →
 beste Teiler 51.6 (17.) 161.2 (13.) 174.4 (18.)
 Trefferlage 0.56 mm rechts, 0.18 mm tief
 Streuwert 3.20, horizontal: 3.49, vertikal: 2.88

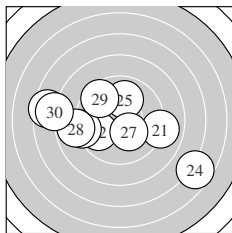

Serie 3:
 9.0 → 9.8 ↙ 7.5 ← 6.7 ↘ 10.0 ↑
 9.1 ← 10.2 * 8.8 ← 9.6 ↘ 7.8 ←
 beste Teiler 178.0 (27.) 250.7 (25.) 283.7 (22.)
 Trefferlage 1.53 mm links, 0.44 mm tief
 Streuwert 4.28, horizontal: 5.52, vertikal: 2.48

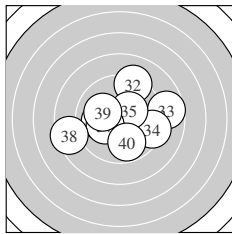

Serie 4:
 10.4 * 9.2 ↑ 8.7 → 9.3 → 10.4 *
 10.0 ← 10.2 * 8.4 ← 10.1 ↖ 9.8 ↓
 beste Teiler 126.3 (31.) 148.6 (35.) 186.0 (37.)
 Trefferlage 0.22 mm rechts, 0.04 mm hoch
 Streuwert 2.72, horizontal: 3.33, vertikal: 1.92

Unterschrift des Schützen

Ergebnis: **389.4** (373)
 Serien: 99.2 95.7 96.5 98.0
 Zähler: 18 18 3 1 0 0 0 0 0 0
 Innenzehner: 12
 weiteste: 766 (13), 640 (9), 516 (23)
 beste Teiler 60.2 (6.) 98.2 (5.) 105.5 (8.)
 Trefferlage 0.65 mm links, 0.82 mm hoch
 Streuwert 2.31, horizontal: 2.56, vertikal: 2.04

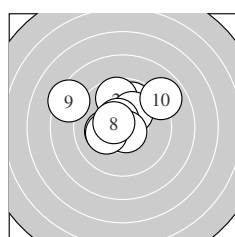
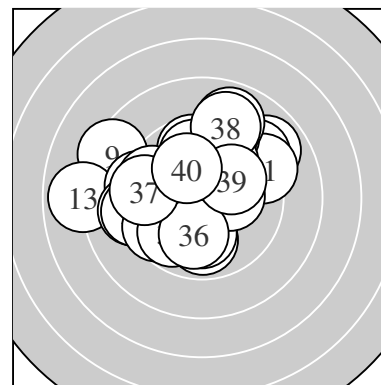

Serie 1:
 9.8 ↗ 9.7 ↑ 10.2 * 10.2 * 10.6 *
 10.7 * 10.2 * 10.5 * 8.4 ↖ 8.9 ↗
 beste Teiler 60.2 (6.) 98.2 (5.) 105.5 (8.)
 Trefferlage 0.49 mm links, 1.29 mm hoch
 Streuwert 2.09, horizontal: 2.53, vertikal: 1.53

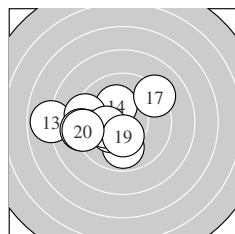

Serie 2:
 9.9 ↓ 10.3 * 7.9 ← 10.2 * 9.3 ←
 10.2 * 9.2 ↗ 9.1 ← 10.4 * 9.2 ←
 beste Teiler 147.1 (19.) 159.0 (12.) 181.8 (16.)
 Trefferlage 2.04 mm links, 0.20 mm tief
 Streuwert 2.48, horizontal: 3.12, vertikal: 1.61

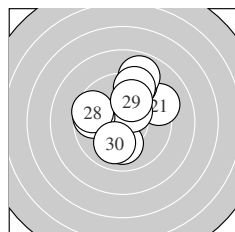

Serie 3:
 9.2 ↗ 9.3 ↑ 8.9 ↑ 10.0 ↓ 10.4 *
 9.7 ← 9.4 ↑ 9.6 ↖ 10.0 ↑ 10.0 ↓
 beste Teiler 149.1 (25.) 228.0 (24.) 237.1 (30.)
 Trefferlage 0.30 mm rechts, 1.50 mm hoch
 Streuwert 2.30, horizontal: 2.19, vertikal: 2.41

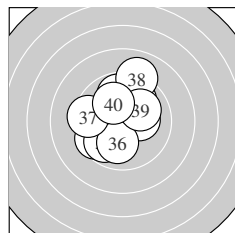

Serie 4:
 10.2 * 9.8 ↑ 9.9 ↗ 9.6 ↖ 9.8 ↖
 10.0 ↓ 9.5 ← 9.0 ↑ 10.1 ↗ 10.1 ↘
 beste Teiler 179.4 (31.) 214.6 (40.) 223.3 (39.)
 Trefferlage 0.39 mm links, 0.70 mm hoch
 Streuwert 2.17, horizontal: 2.02, vertikal: 2.30

Unterschrift des Schützen

Meyton Elektronik

Ergebnis: **398.2** (382)
 Serien: 100.2 98.7 101.9 97.4
 Zähler: 23 16 1 0 0 0 0 0 0 0
 Innenzehner: 16
 weiteste: 525 (38), 463 (17), 456 (35)
 beste Teiler 45.0 (30.) 54.5 (31.) 84.0 (1.)
 Trefferlage 0.21 mm links, 0.84 mm hoch
 Streuwert 1.90, horizontal: 2.32, vertikal: 1.35

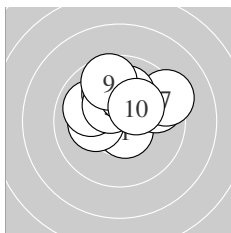
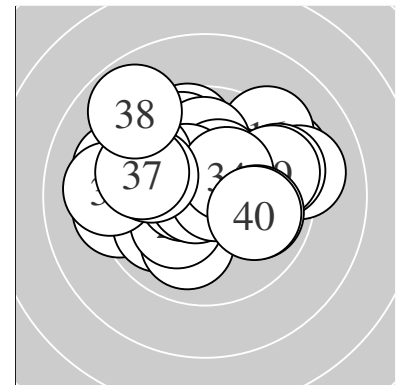

Serie 1:
 10.6 * 10.2 * 10.0 ↖ 10.0 ↗ 10.4 *
 9.7 ↘ 9.3 ↘ 10.0 ↑ 9.7 ↑ 10.3 *
 beste Teiler 84.0 (1.) 147.8 (5.) 175.7 (10.)
 Trefferlage 0.23 mm rechts, 1.32 mm hoch
 Streuwert 1.60, horizontal: 1.95, vertikal: 1.13

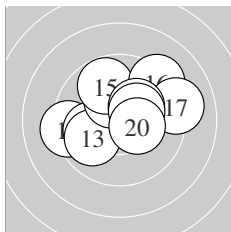

Serie 2:
 9.3 ← 10.0 ← 9.9 ↙ 10.3 * 9.8 ↗
 9.3 ↗ 9.1 → 10.3 * 10.3 * 10.4 *
 beste Teiler 147.6 (20.) 153.4 (19.) 172.1 (18.)
 Trefferlage 0.12 mm rechts, 0.69 mm hoch
 Streuwert 2.15, horizontal: 2.64, vertikal: 1.51

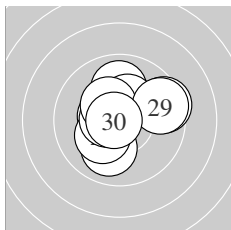

Serie 3:
 10.0 ↓ 10.0 ↑ 9.5 → 10.5 * 10.2 *
 10.3 * 10.6 * 10.4 * 9.6 → 10.8 *
 beste Teiler 45.0 (30.) 98.3 (27.) 117.4 (24.)
 Trefferlage 0.16 mm rechts, 0.43 mm hoch
 Streuwert 1.59, horizontal: 1.79, vertikal: 1.37

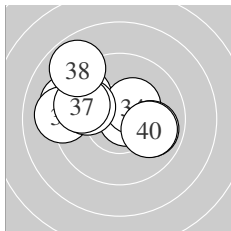

Serie 4:
 10.7 * 9.6 ↖ 9.2 ↖ 10.4 * 9.1 ←
 9.9 ↖ 9.7 ↖ 8.9 ↖ 9.9 → 10.0 →
 beste Teiler 54.5 (31.) 147.7 (34.) 249.8 (40.)
 Trefferlage 1.40 mm links, 0.91 mm hoch
 Streuwert 2.16, horizontal: 2.71, vertikal: 1.40

Unterschrift des Schützen

Ergebnis: **405.9** (389)
 Serien: 100.5 100.4 103.3 101.7
 Zähler: 30 9 1 0 0 0 0 0 0
 Innenzehner: 23
 weiteste: 562 (28), 425 (19), 425 (38)
 beste Teiler 30.2 (27.) 83.7 (24.) 88.5 (6.)
 Trefferlage 0.05 mm rechts, 0.92 mm hoch
 Streuwert 1.49, horizontal: 1.61, vertikal: 1.36

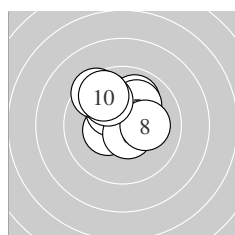
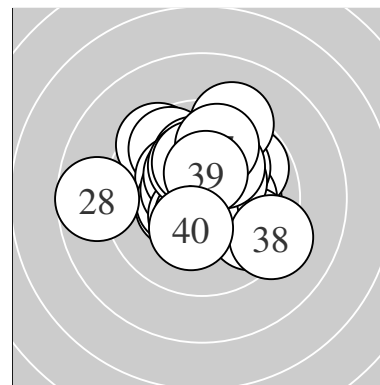

Serie 1:
 10.4 * 9.9 ↘ 10.0 ↗ 10.3 * 10.1 ↗
 10.6 * 9.5 ↘ 10.1 → 9.9 ↘ 9.7 ↘
 beste Teiler 88.5 (6.) 139.4 (1.) 162.7 (4.)
 Trefferlage 0.41 mm links, 1.40 mm hoch
 Streuwert 1.41, horizontal: 1.48, vertikal: 1.33

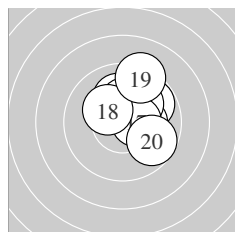

Serie 2:
 10.1 ↗ 10.1 ↑ 9.8 ↗ 10.2 * 10.3 *
 10.1 ↗ 10.5 * 10.3 * 9.3 ↗ 9.7 ↘
 beste Teiler 121.1 (17.) 172.5 (18.) 174.1 (15.)
 Trefferlage 1.04 mm rechts, 1.22 mm hoch
 Streuwert 1.37, horizontal: 1.24, vertikal: 1.50

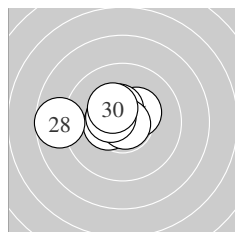

Serie 3:
 10.4 * 10.5 * 10.6 * 10.6 * 10.4 *
 10.5 * 10.8 * 8.7 ← 10.5 * 10.3 *
 beste Teiler 30.2 (27.) 83.7 (24.) 94.2 (23.)
 Trefferlage 0.80 mm links, 0.52 mm hoch
 Streuwert 1.38, horizontal: 1.87, vertikal: 0.55

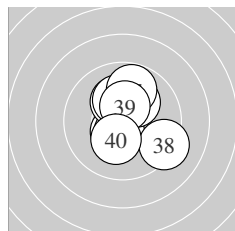

Serie 4:
 10.5 * 10.6 * 10.3 * 10.2 * 10.1 ↗
 10.2 * 9.8 ↑ 9.3 ↘ 10.4 * 10.3 *
 beste Teiler 100.5 (32.) 112.8 (31.) 135.4 (39.)
 Trefferlage 0.38 mm rechts, 0.54 mm hoch
 Streuwert 1.55, horizontal: 1.33, vertikal: 1.74

Unterschrift des Schützen

Ergebnis: **402.7** (387)
 Serien: 101.7 100.7 99.0 101.3
 Zähler: 27 13 0 0 0 0 0 0 0 0
 Innenzehner: 19
 weiteste: 455 (14), 437 (27), 423 (18)
 beste Teiler 52.0 (6.) 61.4 (29.) 91.2 (10.)
 Trefferlage 0.00 mm , 0.14 mm tief
 Streuwert 1.76, horizontal: 1.70, vertikal: 1.81

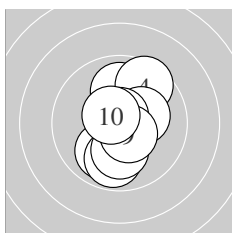
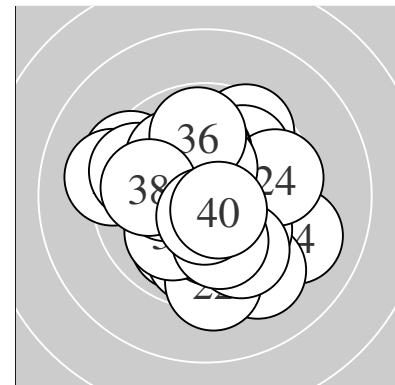

Serie 1:
 10.2 * 10.0 ↙ 10.0 ↑ 9.6 ↗ 10.2 *
 10.7 * 9.8 ↓ 10.1 ↓ 10.5 * 10.6 *
 beste Teiler 52.0 (6.) 91.2 (10.) 107.1 (9.)
 Trefferlage 0.26 mm rechts, 0.11 mm hoch
 Streuwert 1.58, horizontal: 1.00, vertikal: 2.00

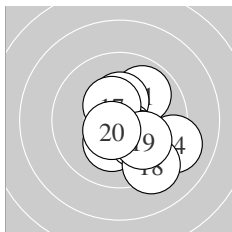

Serie 2:
 9.9 ↗ 10.4 * 10.2 * 9.1 ↘ 10.6 *
 10.2 * 10.4 * 9.3 ↘ 10.0 ↘ 10.6 *
 beste Teiler 95.7 (15.) 100.6 (20.) 128.8 (17.)
 Trefferlage 1.01 mm rechts, 0.71 mm tief
 Streuwert 1.65, horizontal: 1.58, vertikal: 1.72

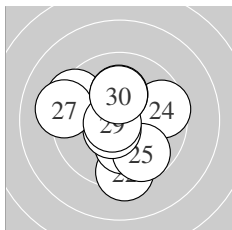

Serie 3:
 9.4 ↖ 9.3 ↓ 10.2 * 9.6 → 9.7 ↘
 10.6 * 9.2 ← 10.1 ↑ 10.7 * 10.2 *
 beste Teiler 61.4 (29.) 93.8 (26.) 194.1 (23.)
 Trefferlage 0.34 mm links, 0.20 mm tief
 Streuwert 2.13, horizontal: 2.20, vertikal: 2.07

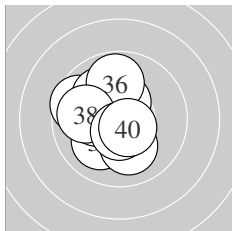

Serie 4:
 10.1 ↙ 9.6 ↖ 10.4 * 10.2 * 10.0 ↖
 9.8 ↑ 10.1 ↓ 9.9 ← 10.6 * 10.6 *
 beste Teiler 91.2 (40.) 95.0 (39.) 131.3 (33.)
 Trefferlage 0.93 mm links, 0.21 mm hoch
 Streuwert 1.47, horizontal: 1.36, vertikal: 1.57

Unterschrift des Schützen

Meyton Elektronik

Ergebnis: **367.1** (349)
 Serien: 91.9 92.9 89.4 92.9
 Zähler: 9 16 11 3 1 0 0 0 0 0
 Innenzehner: 5
 weiteste: 1008 (20), 957 (22), 905 (40)
 beste Teiler 90.7 (5.) 93.6 (15.) 146.8 (28.)
 Trefferlage 0.38 mm rechts, 0.35 mm tief
 Streuwert 3.53, horizontal: 3.21, vertikal: 3.82

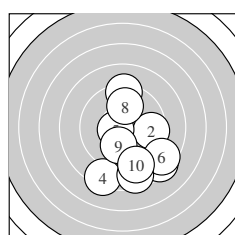
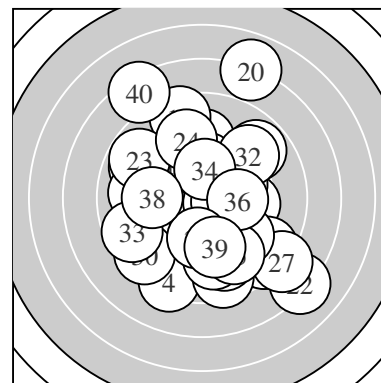

Serie 1:
 9.2 ↑ 9.5 → 8.4 ↘ 8.3 ↓ 10.6 *
 8.5 ↘ 8.5 ↓ 9.9 ↑ 10.0 ↓ 9.0 ↓
 beste Teiler 90.7 (5.) 227.3 (9.) 260.7 (8.)
 Trefferlage 1.27 mm rechts, 2.07 mm tief
 Streuwert 3.03, horizontal: 2.41, vertikal: 3.55

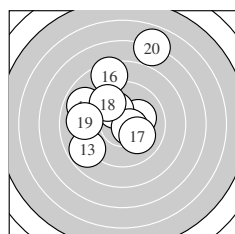

Serie 2:
 10.1 → 10.2 * 8.8 ↙ 8.9 ↖ 10.6 *
 8.5 ↑ 10.1 ↘ 9.7 ↘ 9.1 ← 6.9 ↑
 beste Teiler 93.6 (15.) 192.3 (12.) 205.0 (11.)
 Trefferlage 0.98 mm links, 1.83 mm hoch
 Streuwert 3.31, horizontal: 2.97, vertikal: 3.62

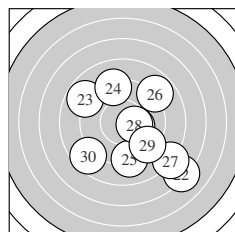

Serie 3:
 10.2 * 7.1 ↘ 8.8 ↖ 9.2 ↑ 9.1 ↓
 8.8 ↗ 7.9 ↘ 10.4 * 9.3 ↘ 8.6 ↙
 beste Teiler 146.8 (28.) 176.6 (21.) 411.3 (29.)
 Trefferlage 1.41 mm rechts, 1.25 mm tief
 Streuwert 3.86, horizontal: 3.91, vertikal: 3.80

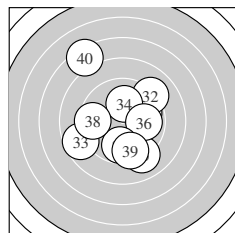

Serie 4:
 9.9 → 9.1 ↗ 8.7 ↙ 10.1 ↑ 9.1 ↓
 9.9 → 9.8 ↓ 9.5 ← 9.5 ↓ 7.3 ↘
 beste Teiler 211.9 (34.) 262.3 (36.) 275.0 (31.)
 Trefferlage 0.16 mm links, 0.07 mm hoch
 Streuwert 3.44, horizontal: 3.21, vertikal: 3.66

Unterschrift des Schützen

Meyton Elektronik

Ergebnis: **386.6** (372)
 Serien: 94.3 93.1 100.2 99.0
 Zähler: 18 16 6 0 0 0 0 0 0 0
 Innenzehner: 9
 weiteste: 643 (18), 636 (20), 609 (2)
 beste Teiler 87.3 (31.) 104.6 (24.) 106.4 (22.)
 Trefferlage 0.57 mm links, 0.50 mm tief
 Streuwert 2.51, horizontal: 2.67, vertikal: 2.34

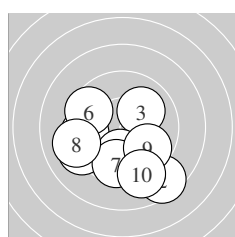
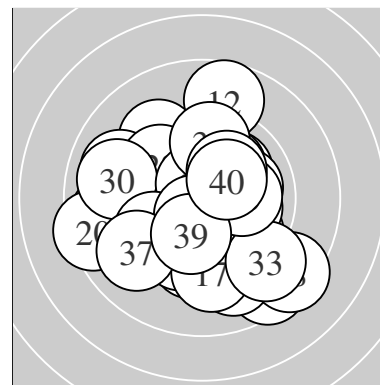

Serie 1:
 9.2 ↙ 8.5 ↘ 10.0 ↗ 9.5 ← 10.0 ↓
 9.6 ↖ 9.6 ↓ 9.1 ← 9.7 ↘ 9.1 ↓
 beste Teiler 229.5 (3.) 245.0 (5.) 303.1 (9.)
 Trefferlage 0.61 mm links, 1.81 mm tief
 Streuwert 2.58, horizontal: 2.93, vertikal: 2.18

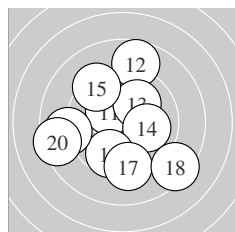

Serie 2:
 10.3 * 8.7 ↑ 10.1 ↗ 10.0 → 9.3 ↘
 9.7 ↓ 9.3 ↓ 8.4 ↘ 8.9 ← 8.4 ←
 beste Teiler 160.3 (11.) 217.8 (13.) 232.3 (14.)
 Trefferlage 0.58 mm links, 0.30 mm tief
 Streuwert 3.27, horizontal: 3.36, vertikal: 3.18

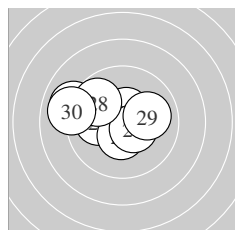

Serie 3:
 10.4 * 10.5 * 10.1 ← 10.5 * 10.4 *
 9.0 ↖ 10.5 * 9.8 ↖ 10.0 → 9.0 ←
 beste Teiler 104.6 (24.) 106.4 (22.) 117.1 (27.)
 Trefferlage 1.23 mm links, 0.57 mm hoch
 Streuwert 1.76, horizontal: 2.30, vertikal: 0.95

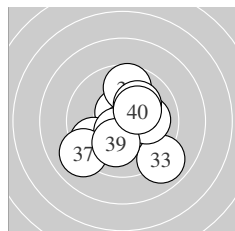

Serie 4:
 10.6 * 9.6 ↙ 8.9 ↘ 9.7 ↑ 10.5 *
 10.1 → 9.1 ↙ 10.1 ↗ 10.1 ↓ 10.3 *
 beste Teiler 87.3 (31.) 106.9 (35.) 172.2 (40.)
 Trefferlage 0.12 mm rechts, 0.48 mm tief
 Streuwert 2.17, horizontal: 2.19, vertikal: 2.15

Unterschrift des Schützen

Meyton Elektronik

Ergebnis: **396.8** (379)
 Serien: 101.9 95.5 100.4 99.0
 Zähler: 22 15 3 0 0 0 0 0 0 0
 Innenzehner: 18
 weiteste: 587 (17), 518 (16), 511 (5)
 beste Teiler 15.0 (28.) 51.0 (22.) 68.4 (10.)
 Trefferlage 0.40 mm links, 0.32 mm hoch
 Streuwert 2.09, horizontal: 2.25, vertikal: 1.91

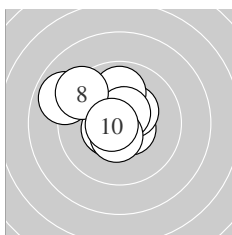
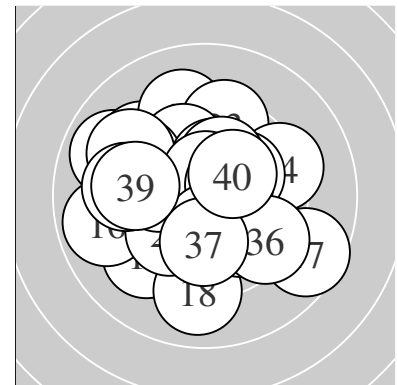

Serie 1:
 10.5 * 10.6 * 10.4 * 10.5 * 8.9 ↖
 9.9 ↑ 10.6 * 9.3 ↘ 10.5 * 10.7 *
 beste Teiler 68.4 (10.) 93.1 (7.) 96.2 (2.)
 Trefferlage 0.83 mm links, 0.63 mm hoch
 Streuwert 1.61, horizontal: 1.80, vertikal: 1.39

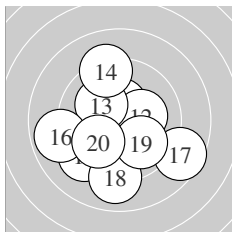

Serie 2:
 10.4 * 10.2 * 10.1 ↘ 9.2 ↑ 9.3 ↙
 8.9 ← 8.6 ↘ 9.0 ↓ 9.9 ↘ 9.9 ↙
 beste Teiler 131.3 (11.) 186.5 (12.) 203.5 (13.)
 Trefferlage 0.40 mm links, 0.85 mm tief
 Streuwert 2.74, horizontal: 2.84, vertikal: 2.64

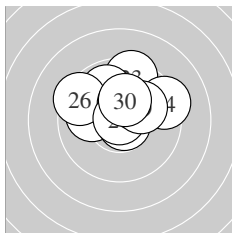

Serie 3:
 10.0 ↖ 10.7 * 9.4 ↑ 9.3 → 9.9 ↗
 9.4 ↘ 10.4 * 10.9 * 10.1 → 10.3 *
 beste Teiler 15.0 (28.) 51.0 (22.) 144.3 (27.)
 Trefferlage 0.09 mm rechts, 1.37 mm hoch
 Streuwert 1.65, horizontal: 2.03, vertikal: 1.16

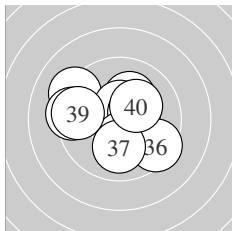

Serie 4:
 9.2 ↘ 10.2 * 10.5 * 10.4 * 10.3 *
 9.4 ↘ 10.0 ↓ 9.3 ← 9.5 ← 10.2 *
 beste Teiler 105.0 (33.) 135.5 (34.) 163.4 (35.)
 Trefferlage 0.46 mm links, 0.14 mm hoch
 Streuwert 2.09, horizontal: 2.47, vertikal: 1.63

Unterschrift des Schützen

Ergebnis: **390.2** (372)
 Serien: 96.1 97.6 97.7 98.8
 Zähler: 17 18 5 0 0 0 0 0 0 0
 Innenzehner: 11
 weiteste: 596 (2), 539 (5), 536 (12)
 beste Teiler 86.1 (27.) 101.8 (14.) 132.0 (35.)
 Trefferlage 0.56 mm rechts, 0.43 mm hoch
 Streuwert 2.30, horizontal: 2.51, vertikal: 2.05

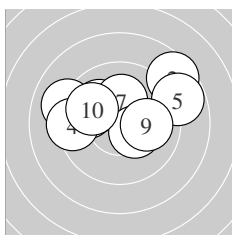
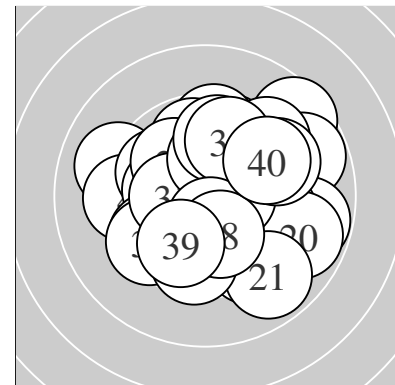

Serie 1:
 9.8 ↖ 8.6 ↗ 9.1 ↖ 9.3 ← 8.8 ↗
 10.0 ↖ 10.2 * 10.4 * 10.0 → 9.9 ↖
 beste Teiler 150.9 (8.) 194.5 (7.) 231.2 (6.)
 Trefferlage 0.20 mm links, 1.20 mm hoch
 Streuwert 2.59, horizontal: 3.41, vertikal: 1.33

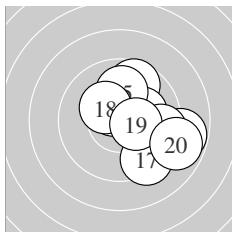

Serie 2:
 9.7 ↑ 8.8 → 10.2 * 10.5 * 10.0 ↑
 9.5 → 9.3 ↘ 10.3 * 10.4 * 8.9 →
 beste Teiler 101.8 (14.) 144.0 (19.) 162.1 (18.)
 Trefferlage 1.88 mm rechts, 0.01 mm hoch
 Streuwert 2.06, horizontal: 2.15, vertikal: 1.97

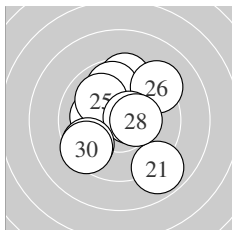

Serie 3:
 8.9 ↘ 9.5 ↑ 10.1 ← 9.8 ↑ 10.0 ↖
 9.3 ↗ 10.6 * 10.4 * 9.6 ↙ 9.5 ↙
 beste Teiler 86.1 (27.) 140.0 (28.) 204.3 (23.)
 Trefferlage 0.06 mm links, 0.29 mm hoch
 Streuwert 2.39, horizontal: 2.26, vertikal: 2.51

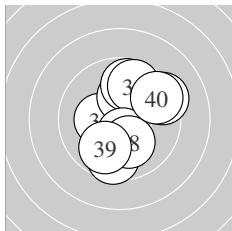

Serie 4:
 10.3 * 10.2 * 9.8 ↑ 9.7 ↑ 10.4 *
 9.3 → 9.6 ↓ 10.1 ↓ 9.9 ↓ 9.5 →
 beste Teiler 132.0 (35.) 166.0 (31.) 193.3 (32.)
 Trefferlage 0.66 mm rechts, 0.22 mm hoch
 Streuwert 2.05, horizontal: 1.72, vertikal: 2.33

Unterschrift des Schützen

Meyton Elektronik

Ergebnis: **415.9** (398)
 Serien: 103.4 103.7 104.0 104.8
 Zähler: 38 2 0 0 0 0 0 0 0 0
 Innenzehner: 31
 weiteste: 285 (3), 259 (27), 249 (19)
 beste Teiler 0.0 (15.) 41.1 (40.) 45.4 (8.)
 Trefferlage 0.16 mm links, 0.06 mm hoch
 Streuwert 1.10, horizontal: 1.20, vertikal: 0.99

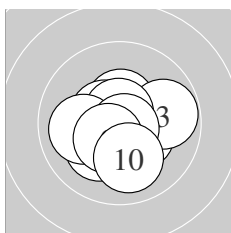
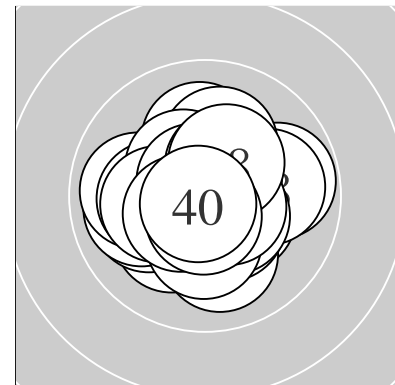

Serie 1:
 10.4 * 10.5 * 9.8 → 10.5 * 10.7 *
 10.2 * 10.0 ← 10.8 * 10.5 * 10.0 ↓
 beste Teiler 45.4 (8.) 64.2 (5.) 109.6 (4.)
 Trefferlage 0.03 mm links, 0.31 mm tief
 Streuwert 1.27, horizontal: 1.43, vertikal: 1.08

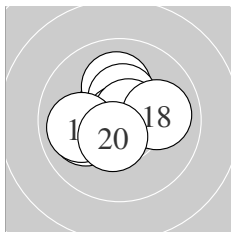

Serie 2:
 10.5 * 10.6 * 10.1 ↑ 10.4 * 10.9 *
 10.7 * 10.0 ← 10.0 → 10.0 ← 10.5 *
 beste Teiler 0.0 (15.) 70.2 (16.) 78.5 (12.)
 Trefferlage 0.30 mm links, 0.36 mm hoch
 Streuwert 1.18, horizontal: 1.36, vertikal: 0.98

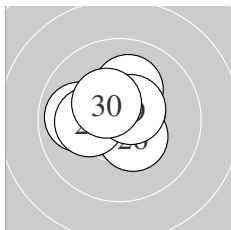

Serie 3:
 10.4 * 10.7 * 10.6 * 10.7 * 10.1 ↑
 10.4 * 9.9 ← 10.2 * 10.6 * 10.4 *
 beste Teiler 51.1 (22.) 66.3 (24.) 79.4 (23.)
 Trefferlage 0.30 mm links, 0.42 mm hoch
 Streuwert 1.05, horizontal: 1.19, vertikal: 0.90

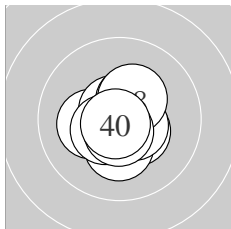

Serie 4:
 10.4 * 10.2 * 10.3 * 10.7 * 10.4 *
 10.6 * 10.5 * 10.3 * 10.6 * 10.8 *
 beste Teiler 41.1 (40.) 68.0 (34.) 79.2 (39.)
 Trefferlage 0.00 mm , 0.20 mm tief
 Streuwert 0.92, horizontal: 0.90, vertikal: 0.94

Unterschrift des Schützen

Meyton Elektronik

Ergebnis: **392.6** (377)
 Serien: 98.0 97.9 99.7 97.0
 Zähler: 21 15 4 0 0 0 0 0 0 0
 Innenzehner: 16
 weiteste: 724 (36), 629 (14), 552 (33)
 beste Teiler 23.8 (15.) 27.6 (6.) 59.0 (30.)
 Trefferlage 0.30 mm links, 0.56 mm hoch
 Streuwert 2.32, horizontal: 2.77, vertikal: 1.77

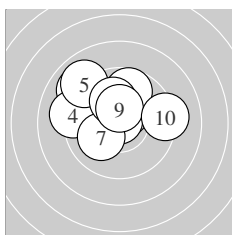
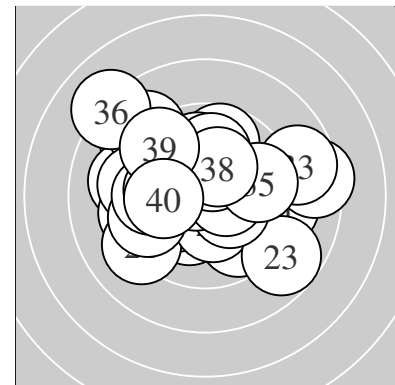

Serie 1:
 10.5 * 9.7 ↑ 9.0 ↘ 9.2 ← 9.0 ↘
 10.8 * 10.1 ↙ 10.1 ↑ 10.4 * 9.2 →
 beste Teiler 27.6 (6.) 111.8 (1.) 140.0 (9.)
 Trefferlage 0.81 mm links, 1.47 mm hoch
 Streuwert 2.13, horizontal: 2.59, vertikal: 1.52

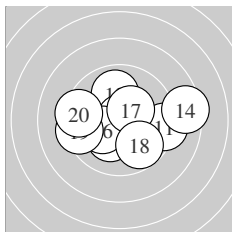

Serie 2:
 9.3 → 9.9 ↑ 10.2 * 8.4 → 10.9 *
 10.2 * 10.4 * 9.8 ↘ 9.4 ← 9.4 ←
 beste Teiler 23.8 (15.) 145.0 (17.) 185.4 (16.)
 Trefferlage 0.28 mm rechts, 0.12 mm tief
 Streuwert 2.50, horizontal: 3.22, vertikal: 1.45

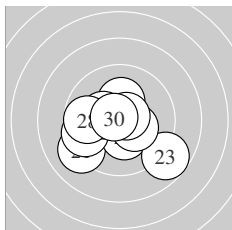

Serie 3:
 9.1 ↙ 10.3 * 8.8 ↘ 9.6 ← 10.2 *
 10.3 * 10.3 * 9.7 ← 10.7 * 10.7 *
 beste Teiler 59.0 (30.) 73.0 (29.) 157.5 (22.)
 Trefferlage 0.50 mm links, 0.66 mm tief
 Streuwert 2.07, horizontal: 2.46, vertikal: 1.58

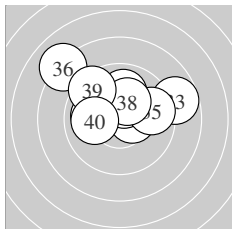

Serie 4:
 10.5 * 10.0 ← 8.7 → 10.4 * 9.7 →
 8.1 ↘ 10.0 ↑ 10.2 * 9.4 ↘ 10.0 ←
 beste Teiler 119.0 (31.) 144.2 (34.) 180.0 (38.)
 Trefferlage 0.17 mm links, 1.58 mm hoch
 Streuwert 2.43, horizontal: 3.07, vertikal: 1.53

Unterschrift des Schützen

Ergebnis: **386.1** (370)
 Serien: 94.4 96.6 96.4 98.7
 Zähler: 15 20 5 0 0 0 0 0 0 0
 Innenzehner: 11
 weiteste: 722 (3), 626 (26), 590 (19)
 beste Teiler 103.0 (17.) 109.8 (13.) 122.5 (33.)
 Trefferlage 0.32 mm rechts, 1.01 mm hoch
 Streuwert 2.45, horizontal: 2.51, vertikal: 2.40

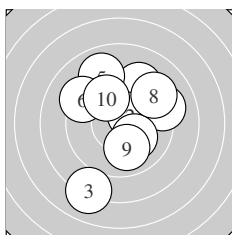
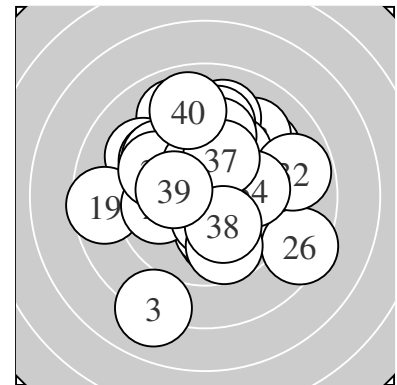

Serie 1:
 9.3 ↗ 10.4 * 8.1 ↘ 9.2 → 9.0 ↖
 9.2 ↖ 10.2 * 9.2 ↗ 10.0 ↓ 9.8 ↖
 beste Teiler 130.2 (2.) 197.4 (7.) 247.1 (9.)
 Trefferlage 0.29 mm rechts, 0.77 mm hoch
 Streuwert 3.01, horizontal: 2.63, vertikal: 3.34

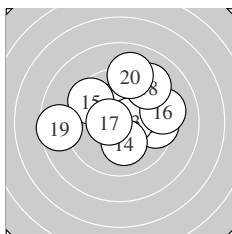

Serie 2:
 10.3 * 9.5 → 10.5 * 10.1 ↓ 9.6 ↖
 9.2 → 10.5 * 9.2 ↗ 8.6 ← 9.1 ↑
 beste Teiler 103.0 (17.) 109.8 (13.) 160.6 (11.)
 Trefferlage 0.28 mm rechts, 1.00 mm hoch
 Streuwert 2.56, horizontal: 3.04, vertikal: 1.97

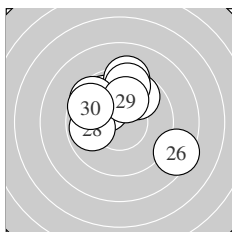

Serie 3:
 9.8 ↗ 9.9 ↖ 9.3 ↑ 9.5 ↑ 10.2 *
 8.4 ↘ 9.6 ↖ 9.9 ← 10.1 ↑ 9.7 ↖
 beste Teiler 184.5 (25.) 225.8 (29.) 272.6 (28.)
 Trefferlage 0.16 mm links, 1.62 mm hoch
 Streuwert 2.33, horizontal: 2.59, vertikal: 2.04

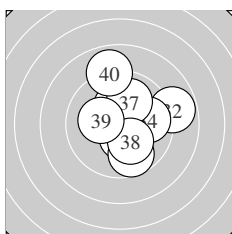

Serie 4:
 10.2 * 8.8 → 10.5 * 9.8 → 10.4 *
 9.7 ↓ 10.0 ↑ 10.2 * 10.2 * 8.9 ↑
 beste Teiler 122.5 (33.) 130.2 (35.) 178.2 (31.)
 Trefferlage 0.86 mm rechts, 0.63 mm hoch
 Streuwert 2.10, horizontal: 1.95, vertikal: 2.24

Unterschrift des Schützen

Ergebnis: **393.8** (377)
 Serien: 95.4 100.4 100.4 97.6
 Zähler: 20 17 3 0 0 0 0 0 0 0
 Innenzehner: 13
 weiteste: 744 (3), 657 (1), 544 (16)
 beste Teiler 47.5 (30.) 101.2 (7.) 113.2 (23.)
 Trefferlage 0.74 mm rechts, 0.07 mm tief
 Streuwert 2.20, horizontal: 2.68, vertikal: 1.57

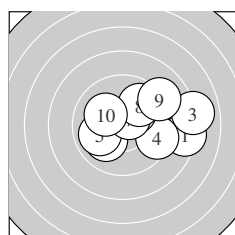
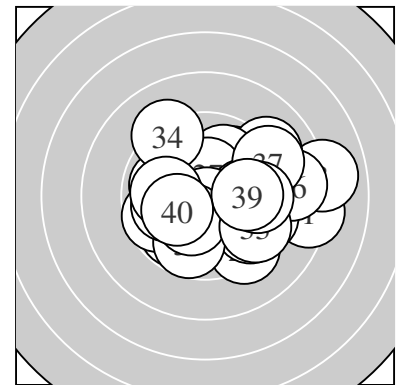

Serie 1:
 8.3 → 10.0 ↙ 8.0 → 9.4 → 9.9 ←
 10.2 * 10.5 * 9.9 ↗ 9.1 ↗ 10.1 ↖
 beste Teiler 101.2 (7.) 185.3 (6.) 208.3 (10.)
 Trefferlage 1.91 mm rechts, 0.45 mm hoch
 Streuwert 2.63, horizontal: 3.40, vertikal: 1.52

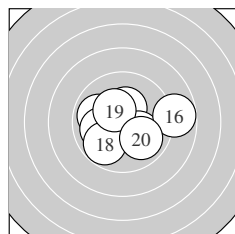

Serie 2:
 10.4 * 9.9 ← 10.5 * 10.2 * 10.5 *
 8.8 → 10.0 ← 9.8 ↙ 10.4 * 9.9 ↘
 beste Teiler 121.3 (13.) 122.0 (15.) 146.1 (11.)
 Trefferlage 0.02 mm links, 0.25 mm tief
 Streuwert 1.93, horizontal: 2.44, vertikal: 1.24

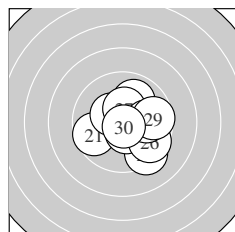

Serie 3:
 9.7 ← 9.3 ↘ 10.5 * 10.4 * 10.0 ↗
 9.6 ↘ 10.4 * 10.0 → 9.7 → 10.8 *
 beste Teiler 47.5 (30.) 113.2 (23.) 140.0 (24.)
 Trefferlage 0.86 mm rechts, 0.31 mm tief
 Streuwert 1.81, horizontal: 1.96, vertikal: 1.64

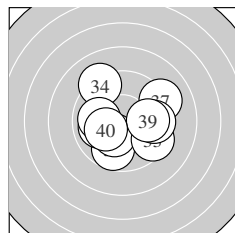

Serie 4:
 9.7 ↓ 10.3 * 9.5 ↘ 9.2 ↖ 10.0 ←
 10.0 ← 9.2 ↗ 9.6 → 9.9 → 10.2 *
 beste Teiler 170.6 (32.) 195.4 (40.) 244.9 (36.)
 Trefferlage 0.22 mm rechts, 0.16 mm tief
 Streuwert 2.35, horizontal: 2.69, vertikal: 1.95

Unterschrift des Schützen

Ergebnis: **401.7** (381)
 Serien: 99.2 101.4 97.4 103.7
 Zähler: 23 15 2 0 0 0 0 0 0 0
 Innenzehner: 19
 weiteste: 555 (25), 553 (22), 464 (29)
 beste Teiler 15.1 (37.) 23.6 (12.) 38.0 (27.)
 Trefferlage 1.24 mm links, 0.00 mm
 Streuwert 1.71, horizontal: 2.00, vertikal: 1.37

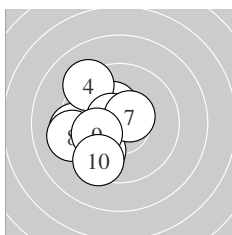
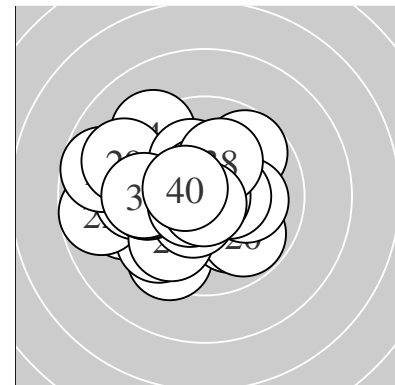

Serie 1:
 10.6 * 10.3 * 9.4 ← 9.2 ↘ 10.6 *
 9.8 ↙ 10.5 * 9.2 ← 10.1 ← 9.5 ↙
 beste Teiler 80.5 (5.) 89.1 (1.) 105.6 (7.)
 Trefferlage 1.62 mm links, 0.17 mm tief
 Streuwert 1.81, horizontal: 1.71, vertikal: 1.90

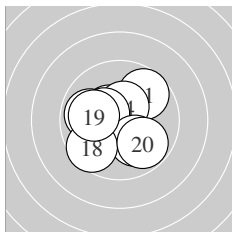

Serie 2:
 9.7 ↗ 10.9 * 10.5 * 10.5 * 10.4 *
 10.1 ↘ 9.9 ← 9.6 ↙ 10.0 ← 9.8 ↘
 beste Teiler 23.6 (12.) 122.8 (14.) 125.3 (13.)
 Trefferlage 0.36 mm links, 0.05 mm tief
 Streuwert 1.67, horizontal: 1.82, vertikal: 1.52

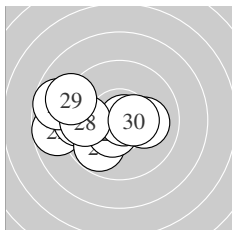

Serie 3:
 10.1 → 8.7 ← 9.5 ← 9.8 ↙ 8.7 ←
 10.5 * 10.8 * 9.7 ← 9.1 ↖ 10.5 *
 beste Teiler 38.0 (27.) 119.0 (26.) 124.0 (30.)
 Trefferlage 2.03 mm links, 0.12 mm tief
 Streuwert 2.10, horizontal: 2.74, vertikal: 1.16

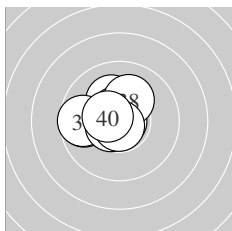

Serie 4:
 9.7 ← 10.5 * 10.2 * 9.7 ← 10.6 *
 10.6 * 10.9 * 10.2 * 10.8 * 10.5 *
 beste Teiler 15.1 (37.) 41.4 (39.) 84.5 (35.)
 Trefferlage 0.95 mm links, 0.38 mm hoch
 Streuwert 1.10, horizontal: 1.31, vertikal: 0.84

Unterschrift des Schützen

Meyton Elektronik

Ergebnis: **370.3** (355)
 Serien: 89.3 96.9 89.5 94.6
 Zähler: 9 19 10 2 0 0 0 0 0 0
 Innenzehner: 7
 weiteste: 895 (21), 796 (33), 731 (1)
 beste Teiler 70.6 (36.) 93.6 (31.) 111.5 (15.)
 Trefferlage 0.70 mm links, 1.93 mm hoch
 Streuwert 3.03, horizontal: 3.20, vertikal: 2.84

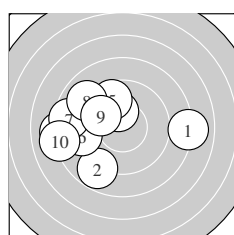
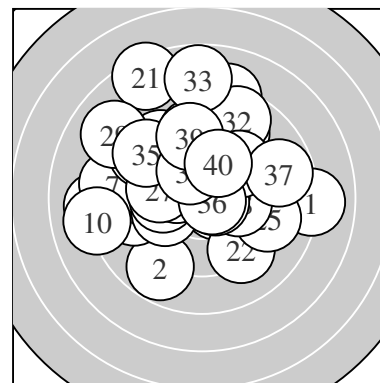

Serie 1:
 8.0 → 8.8 ↘ 8.1 ← 10.2 * 9.6 ↗
 9.1 ← 8.5 ← 9.0 ↘ 9.9 ↘ 8.1 ←
 beste Teiler 180.9 (4.) 272.8 (9.) 327.7 (5.)
 Trefferlage 2.80 mm links, 0.20 mm hoch
 Streuwert 3.40, horizontal: 4.22, vertikal: 2.30

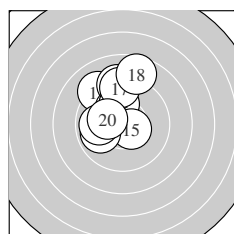

Serie 2:
 9.1 ↘ 9.2 ↑ 10.2 * 10.0 ↑ 10.5 *
 9.9 ← 9.3 ↑ 8.6 ↑ 9.9 ← 10.2 *
 beste Teiler 111.5 (15.) 178.3 (20.) 192.3 (13.)
 Trefferlage 0.91 mm links, 2.05 mm hoch
 Streuwert 1.92, horizontal: 1.48, vertikal: 2.29

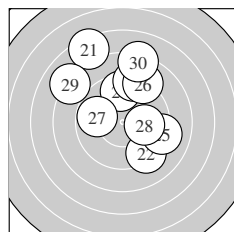

Serie 3:
 7.4 ↗ 9.2 ↘ 9.6 ↑ 9.1 ↑ 9.1 →
 9.0 ↗ 9.8 ← 10.0 → 8.1 ↘ 8.2 ↑
 beste Teiler 245.0 (28.) 289.4 (27.) 344.8 (23.)
 Trefferlage 0.18 mm rechts, 2.69 mm hoch
 Streuwert 3.49, horizontal: 3.29, vertikal: 3.69

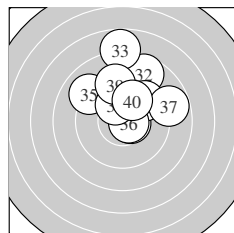

Serie 4:
 10.6 * 8.7 ↗ 7.8 ↑ 9.6 ↗ 9.0 ↘
 10.7 * 8.8 → 10.2 * 9.3 ↑ 9.9 ↑
 beste Teiler 70.6 (36.) 93.6 (31.) 197.8 (38.)
 Trefferlage 0.70 mm rechts, 2.78 mm hoch
 Streuwert 2.43, horizontal: 2.38, vertikal: 2.48

Unterschrift des Schützen

Meyton Elektronik

Ergebnis: **391.1** (371)
 Serien: 97.3 98.5 94.4 100.9
 Zähler: 17 17 6 0 0 0 0 0 0 0
 Innenzehner: 16
 weiteste: 700 (22), 642 (4), 548 (6)
 beste Teiler 54.0 (1.) 79.4 (36.) 84.0 (12.)
 Trefferlage 0.62 mm rechts, 0.03 mm hoch
 Streuwert 2.39, horizontal: 2.64, vertikal: 2.11

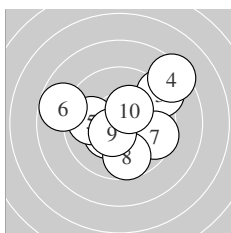
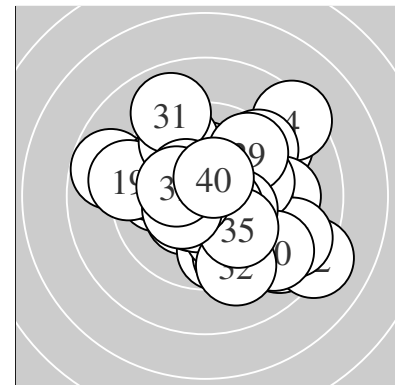

Serie 1:
 10.7 * 10.3 * 9.1 ↗ 8.4 ↗ 9.9 ←
 8.8 ← 9.6 → 9.7 ↓ 10.5 * 10.3 *
 beste Teiler 54.0 (1.) 109.0 (9.) 152.7 (2.)
 Trefferlage 0.34 mm rechts, 0.36 mm hoch
 Streuwert 2.65, horizontal: 3.08, vertikal: 2.12

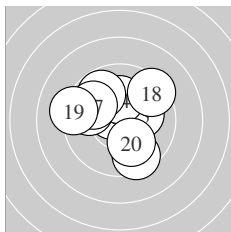

Serie 2:
 9.5 ↓ 10.6 * 10.2 * 10.2 * 9.8 ↖
 9.8 ← 9.8 ↖ 9.4 ↗ 9.2 ← 10.0 ↓
 beste Teiler 84.0 (12.) 191.0 (14.) 198.2 (13.)
 Trefferlage 0.44 mm links, 0.56 mm hoch
 Streuwert 2.14, horizontal: 2.36, vertikal: 1.89

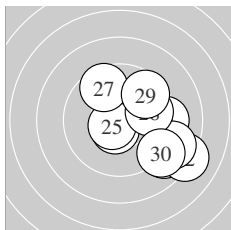

Serie 3:
 8.9 ↘ 8.2 ↘ 10.6 * 9.3 → 10.6 *
 8.8 ↘ 9.6 ↖ 9.8 → 9.6 ↗ 9.0 ↘
 beste Teiler 86.0 (25.) 99.8 (23.) 287.7 (28.)
 Trefferlage 2.58 mm rechts, 0.72 mm tief
 Streuwert 2.46, horizontal: 2.60, vertikal: 2.32

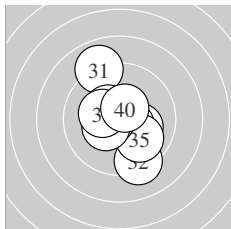

Serie 4:
 8.9 ↖ 9.2 ↓ 10.2 * 10.5 * 9.9 ↘
 10.6 * 10.4 * 10.4 * 10.3 * 10.5 *
 beste Teiler 79.4 (36.) 112.7 (40.) 114.7 (34.)
 Trefferlage 0.02 mm rechts, 0.06 mm tief
 Streuwert 1.89, horizontal: 1.52, vertikal: 2.20

Unterschrift des Schützen