

Ergebnis: **394.2** (376)  
 Serien: 100.7 98.2 97.9 97.4  
 Zähler: 18 20 2 0 0 0 0 0 0 0  
 Innenzehner: 10  
 Weitestе: 581 (39.), 540 (40.), 481 (33.)  
 beste Teiler: 74.7 (9.), 87.0 (36.), 111.4 (35.)  
 Trefferlage: 0.05 mm rechts, 0.49 mm hoch  
 Streuwert: 2.13, horizontal: 2.20, vertikal: 2.05

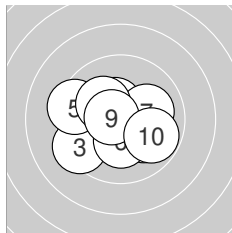
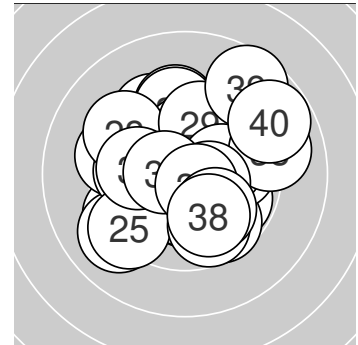

**Serie 1:**

10.3 *	10.0 ↘	9.4 ↙	10.5 *	9.4 ←
10.3 *	10.1 →	10.2 *	10.7 *	9.8 ↘

beste Teiler: 74.7 (9.), 124.4 (4.), 166.1 (1.)  
 Trefferlage: 0.14 mm links, 0.22 mm tief  
 Streuwert: 1.82, horizontal: 2.23, vertikal: 1.30

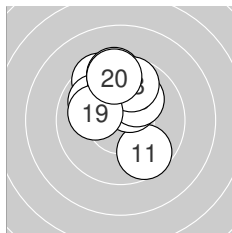

**Serie 2:**

9.7 ↘	10.4 *	9.5 ↘	9.9 ↘	9.8 ↑
10.1 ↗	9.5 ↑	9.7 ↑	10.1 ←	9.5 ↑

beste Teiler: 145.7 (12.), 215.4 (16.), 215.4 (19.)  
 Trefferlage: 0.24 mm links, 1.88 mm hoch  
 Streuwert: 1.68, horizontal: 1.43, vertikal: 1.89

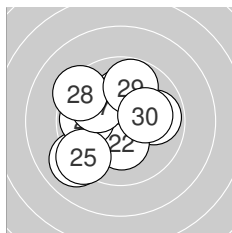

**Serie 3:**

9.9 →	10.3 *	9.1 ↙	9.9 ←	9.3 ↙
10.1 ↑	10.0 ↘	9.4 ↘	9.8 ↑	10.1 →

beste Teiler: 173.2 (22.), 202.0 (26.), 206.6 (30.)  
 Trefferlage: 0.88 mm links, 0.16 mm hoch  
 Streuwert: 2.21, horizontal: 2.31, vertikal: 2.11

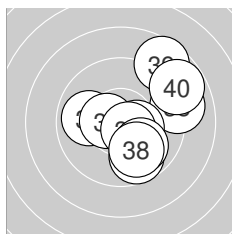

**Serie 4:**

9.7 ↘	9.9 ←	9.0 →	10.4 *	10.5 *
10.6 *	10.0 ↘	9.9 ↘	8.6 ↗	8.8 ↗

beste Teiler: 87.0 (36.), 111.4 (35.), 138.8 (34.)  
 Trefferlage: 1.50 mm rechts, 0.13 mm hoch  
 Streuwert: 2.32, horizontal: 2.29, vertikal: 2.34



Ergebnis: **404.5** (389)  
 Serien: 102.1 100.1 102.1 100.2  
 Zähler: 29 11 0 0 0 0 0 0 0 0  
 Innenzehner: 21  
 Weitestе: 407 (20.), 401 (40.), 398 (15.)  
 beste Teiler: 47.1 (35.), 53.2 (6.), 56.0 (2.)  
 Trefferlage: 0.07 mm rechts, 0.42 mm hoch  
 Streuwert: 1.62, horizontal: 2.02, vertikal: 1.09

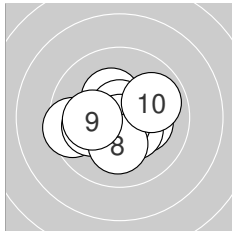
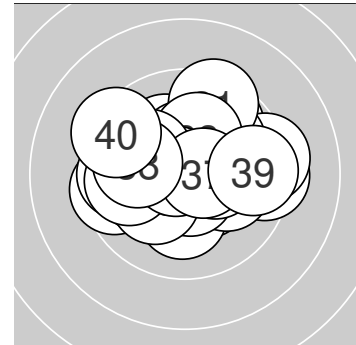

**Serie 1:**

10.3 *	10.7 *	10.2 *	9.5 ←	10.4 *
10.7 *	10.1 ←	10.2 *	10.1 ←	9.9 →

beste Teiler: 53.2 (6.), 56.0 (2.), 139.3 (5.)  
 Trefferlage: 0.32 mm links, 0.24 mm tief  
 Streuwert: 1.48, horizontal: 1.83, vertikal: 1.02

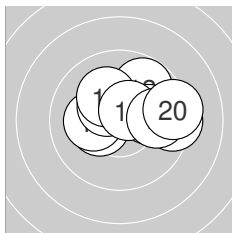

**Serie 2:**

10.3 *	10.2 *	9.8 ↗	10.1 →	9.4 →
10.4 *	10.2 *	10.6 *	9.8 →	9.3 →

beste Teiler: 99.0 (18.), 140.1 (16.), 154.4 (11.)  
 Trefferlage: 0.99 mm rechts, 0.67 mm hoch  
 Streuwert: 1.71, horizontal: 2.25, vertikal: 0.88

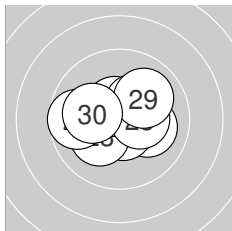

**Serie 3:**

10.1 ↘	10.6 *	10.2 *	10.5 *	9.7 ←
10.3 *	10.3 *	10.3 *	10.0 ↗	10.1 ←

beste Teiler: 89.1 (22.), 102.3 (24.), 151.0 (28.)  
 Trefferlage: 0.09 mm rechts, 0.23 mm hoch  
 Streuwert: 1.44, horizontal: 1.80, vertikal: 0.93

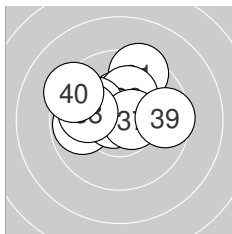

**Serie 4:**

9.4 ↗	10.4 *	10.2 *	9.8 ←	10.8 *
10.1 ↘	10.6 *	10.0 ←	9.6 →	9.3 ↘

beste Teiler: 47.1 (35.), 91.1 (37.), 142.2 (32.)  
 Trefferlage: 0.46 mm links, 1.04 mm hoch  
 Streuwert: 1.73, horizontal: 2.15, vertikal: 1.18



Ergebnis: **403.3** (385)  
 Serien: 100.0 103.1 99.8 100.4  
 Zähler: 25 15 0 0 0 0 0 0 0 0  
 Innenzehner: 20  
 Weitestе: 474 (8.), 461 (30.), 441 (28.)  
 beste Teiler: 10.0 (23.), 32.2 (29.), 33.6 (4.)  
 Trefferlage: 0.16 mm links, 0.73 mm hoch  
 Streuwert: 1.68, horizontal: 2.03, vertikal: 1.24

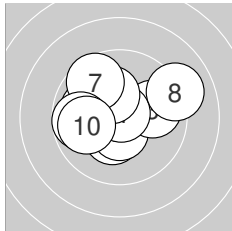
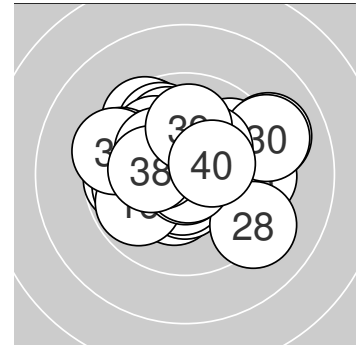

**Serie 1:**

10.3 *	10.5 *	9.9 →	10.8 *	10.0 ←
10.2 *	9.6 ↘	9.1 →	9.7 ←	9.9 ←

beste Teiler: 33.6 (4.), 112.0 (2.), 154.1 (1.)  
 Trefferlage: 0.40 mm links, 0.46 mm hoch  
 Streuwert: 1.92, horizontal: 2.34, vertikal: 1.37

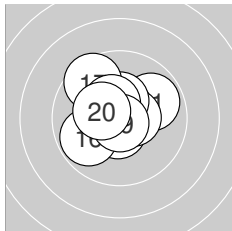

**Serie 2:**

9.9 ↗	10.6 *	10.6 *	10.6 *	10.4 *
9.8 ↙	9.6 ↘	10.4 *	10.8 *	10.4 *

beste Teiler: 37.1 (19.), 77.5 (13.), 91.9 (12.)  
 Trefferlage: 0.27 mm links, 0.50 mm hoch  
 Streuwert: 1.34, horizontal: 1.44, vertikal: 1.24

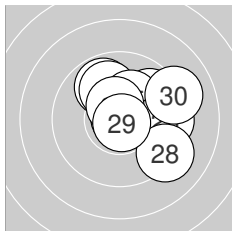

**Serie 3:**

9.8 ↗	9.8 ↘	10.9 *	10.0 ↖	10.2 *
9.5 →	10.5 *	9.2 ↘	10.8 *	9.1 →

beste Teiler: 10.0 (23.), 32.2 (29.), 111.9 (27.)  
 Trefferlage: 1.21 mm rechts, 0.80 mm hoch  
 Streuwert: 1.81, horizontal: 2.03, vertikal: 1.56

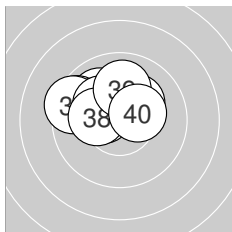

**Serie 4:**

10.4 *	10.2 *	10.0 ↘	9.5 ↙	10.1 ↘
9.4 ↙	10.2 *	10.2 *	10.0 ↑	10.4 *

beste Teiler: 132.5 (31.), 150.4 (40.), 176.9 (38.)  
 Trefferlage: 1.17 mm links, 1.15 mm hoch  
 Streuwert: 1.28, horizontal: 1.69, vertikal: 0.65



Ergebnis: **389.4** (373)  
 Serien: 96.8 98.8 95.1 98.7  
 Zähler: 19 15 6 0 0 0 0 0 0  
 Innenzehner: 13  
 Weitester: 737 (26.), 699 (7.), 576 (34.)  
 beste Teiler: 21.1 (36.), 36.6 (38.), 83.0 (16.)  
 Trefferlage: 0.01 mm rechts, 0.24 mm hoch  
 Streuwert: 2.50, horizontal: 2.49, vertikal: 2.50

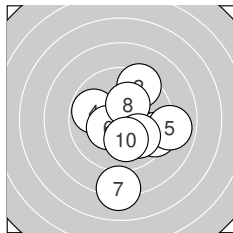
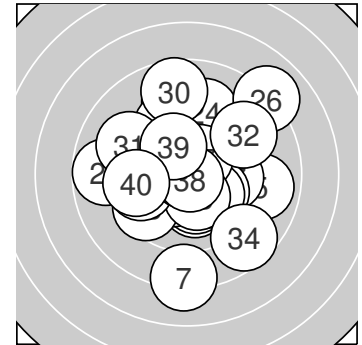

**Serie 1:**  
 10.3 \*                      9.4 ↗                      9.4 ↘                      9.8 ←                      8.9 →  
 10.4 \*                      8.2 ↓                      10.3 \*                      10.0 ↘                      10.1 ↓  
 beste Teiler: 148.1 (6.), 153.3 (1.), 166.8 (8.)  
 Trefferlage: 1.04 mm rechts, 0.91 mm tief  
 Streuwert: 2.47, horizontal: 2.21, vertikal: 2.72

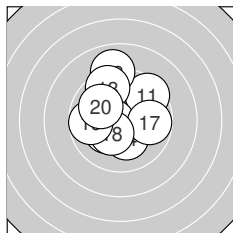

**Serie 2:**  
 9.5 ↗                      9.0 ↑                      9.5 ↖                      10.2 \*                      10.2 \*  
 10.6 \*                      9.8 →                      10.3 \*                      9.7 ←                      10.0 ↖  
 beste Teiler: 83.0 (16.), 158.1 (18.), 183.2 (15.)  
 Trefferlage: 0.41 mm links, 0.73 mm hoch  
 Streuwert: 2.08, horizontal: 1.94, vertikal: 2.21

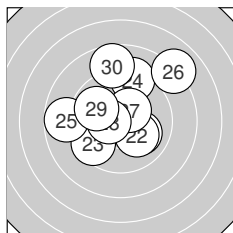

**Serie 3:**  
 10.0 ↘                      10.1 ↘                      9.5 ↙                      9.2 ↑                      8.8 ←  
 8.0 ↗                      10.4 \*                      10.5 \*                      9.9 ↖                      8.7 ↑  
 beste Teiler: 119.1 (28.), 140.2 (27.), 214.3 (22.)  
 Trefferlage: 0.16 mm links, 1.25 mm hoch  
 Streuwert: 2.92, horizontal: 3.04, vertikal: 2.79

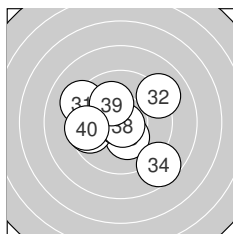

**Serie 4:**  
 9.2 ↖                      9.1 ↗                      10.3 \*                      8.6 ↘                      9.7 ←  
 10.9 \*                      10.4 \*                      10.8 \*                      10.1 ↖                      9.6 ←  
 beste Teiler: 21.1 (36.), 36.6 (38.), 128.5 (37.)  
 Trefferlage: 0.41 mm links, 0.06 mm tief  
 Streuwert: 2.40, horizontal: 2.73, vertikal: 2.02



Ergebnis: **400.3** (383)  
 Serien: 100.5 98.0 100.0 101.8  
 Zähler: 24 15 1 0 0 0 0 0 0  
 Innenzehner: 20  
 Weitester: 697 (20.), 453 (15.), 452 (27.)  
 beste Teiler: 7.2 (38.), 20.6 (33.), 39.0 (7.)  
 Trefferlage: 0.28 mm links, 0.18 mm tief  
 Streuwert: 1.99, horizontal: 2.31, vertikal: 1.61

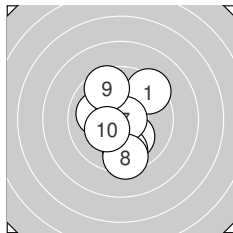
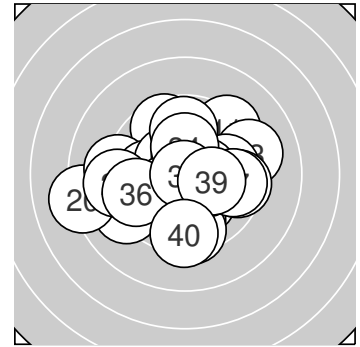

**Serie 1:**  
 9.4 ↗ 10.4 \* 10.6 \* 10.1 ↘ 10.1 ←  
 9.7 ↓ 10.8 \* 9.5 ↓ 9.6 ↗ 10.3 \*  
 beste Teiler: 39.0 (7.), 84.0 (3.), 137.2 (2.)  
 Trefferlage: 0.09 mm links, 0.43 mm tief  
 Streuwert: 1.87, horizontal: 1.48, vertikal: 2.20

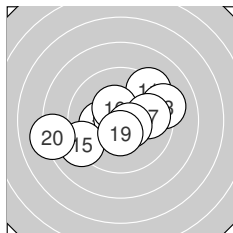

**Serie 2:**  
 9.3 ↗ 10.2 \* 9.2 → 10.8 \* 9.1 ←  
 10.4 \* 9.9 → 10.5 \* 10.4 \* 8.2 ←  
 beste Teiler: 44.2 (14.), 101.8 (18.), 129.0 (19.)  
 Trefferlage: 0.30 mm links, 0.00 mm  
 Streuwert: 2.59, horizontal: 3.30, vertikal: 1.59

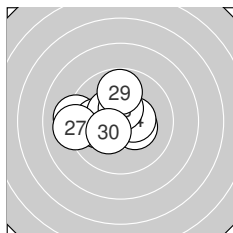

**Serie 3:**  
 9.2 ← 10.3 \* 10.1 ← 10.4 \* 10.0 ←  
 10.4 \* 9.1 ← 10.4 \* 9.8 ↑ 10.3 \*  
 beste Teiler: 126.0 (28.), 127.0 (24.), 141.6 (26.)  
 Trefferlage: 1.32 mm links, 0.29 mm hoch  
 Streuwert: 1.69, horizontal: 2.09, vertikal: 1.15

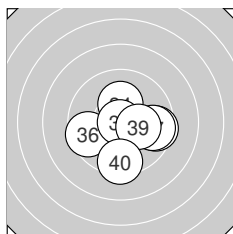

**Serie 4:**  
 10.7 \* 10.7 \* 10.9 \* 10.2 \* 9.5 →  
 9.6 ← 9.7 → 10.9 \* 10.2 \* 9.4 ↓  
 beste Teiler: 7.2 (38.), 20.6 (33.), 55.3 (31.)  
 Trefferlage: 0.58 mm rechts, 0.57 mm tief  
 Streuwert: 1.69, horizontal: 1.91, vertikal: 1.43



Ergebnis: **403.8** (383)  
 Serien: 98.9 102.3 101.5 101.1  
 Zähler: 25 14 0 1 0 0 0 0 0  
 Innenzehner: 21  
 Weitester: 828 (8.), 429 (37.), 375 (10.)  
 beste Teiler: 6.4 (7.), 15.0 (6.), 43.2 (14.)  
 Trefferlage: 0.10 mm rechts, 0.30 mm hoch  
 Streuwert: 1.86, horizontal: 2.12, vertikal: 1.56

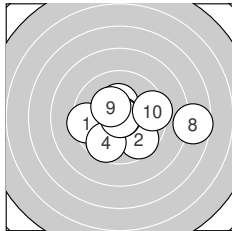
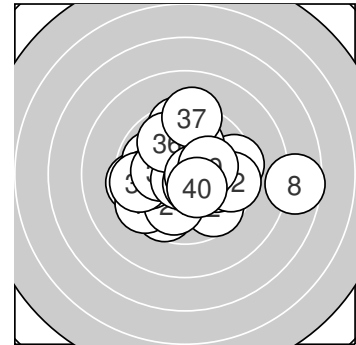

**Serie 1:**

9.5 ←	9.7 ↘	10.5 *	9.7 ↙	10.3 *
10.9 *	10.9 *	7.6 →	10.3 *	9.5 →

beste Teiler: 6.4 (7.), 15.0 (6.), 114.0 (3.)  
 Trefferlage: 0.79 mm rechts, 0.20 mm tief  
 Streuwert: 2.55, horizontal: 3.28, vertikal: 1.49

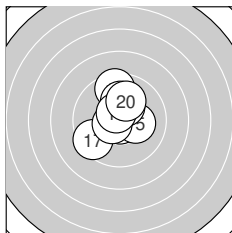

**Serie 2:**

10.7 *	9.5 ↑	10.1 ↑	10.8 *	10.2 *
10.3 *	9.5 ↙	10.6 *	10.6 *	10.0 ↑

beste Teiler: 43.2 (14.), 68.9 (11.), 90.3 (19.)  
 Trefferlage: 0.08 mm links, 0.66 mm hoch  
 Streuwert: 1.49, horizontal: 1.27, vertikal: 1.69

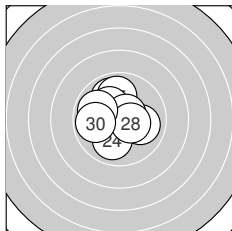

**Serie 3:**

9.9 ↘	10.7 *	10.0 →	10.0 ↙	9.9 ↑
10.2 *	10.6 *	10.4 *	9.9 ↖	9.9 ←

beste Teiler: 68.1 (22.), 91.2 (27.), 131.2 (28.)  
 Trefferlage: 0.41 mm links, 0.35 mm hoch  
 Streuwert: 1.55, horizontal: 1.57, vertikal: 1.52

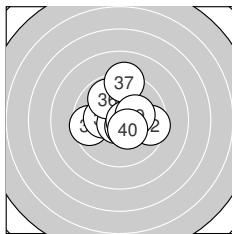

**Serie 4:**

9.6 ←	9.6 →	10.2 *	10.7 *	10.6 *
9.9 ↘	9.2 ↑	10.7 *	10.2 *	10.4 *

beste Teiler: 51.2 (34.), 72.4 (38.), 88.6 (35.)  
 Trefferlage: 0.10 mm rechts, 0.41 mm hoch  
 Streuwert: 1.80, horizontal: 1.93, vertikal: 1.66



Ergebnis: **393.4** (377)  
 Serien: 97.2 101.2 99.0 96.0  
 Zähler: 19 19 2 0 0 0 0 0 0  
 Innenzehner: 15  
 Weitestе: 718 (5.), 549 (40.), 491 (21.)  
 beste Teiler: 91.0 (24.), 91.1 (6.), 96.6 (13.)  
 Trefferlage: 0.74 mm links, 0.34 mm hoch  
 Streuwert: 2.20, horizontal: 2.54, vertikal: 1.80

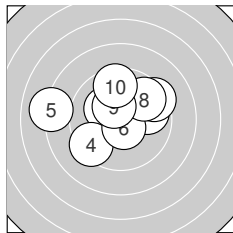
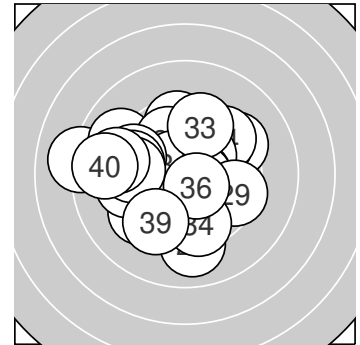

**Serie 1:**  
 10.2 \*                      9.8 →                      10.0 ↑                      9.4 ↙                      8.1 ←  
 10.6 \*                      9.4 ↗                      9.7 ↘                      10.4 \*                      9.6 ↑  
 beste Teiler: 91.1 (6.), 148.0 (9.), 186.4 (1.)  
 Trefferlage: 0.38 mm links, 1.05 mm hoch  
 Streuwert: 2.51, horizontal: 3.10, vertikal: 1.71

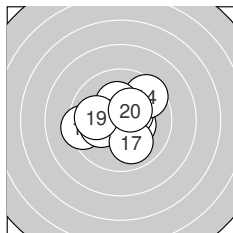

**Serie 2:**  
 10.4 \*                      10.5 \*                      10.6 \*                      9.5 ↗                      9.4 ←  
 10.1 ←                      10.0 ↓                      10.3 \*                      10.0 ←                      10.4 \*  
 beste Teiler: 96.6 (13.), 124.3 (12.), 143.5 (20.)  
 Trefferlage: 0.13 mm links, 0.30 mm hoch  
 Streuwert: 1.72, horizontal: 2.03, vertikal: 1.34

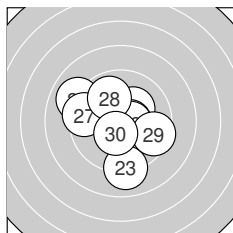

**Serie 3:**  
 9.0 ↖                      10.2 \*                      9.0 ↓                      10.6 \*                      10.4 \*  
 10.6 \*                      9.4 ←                      9.9 ↗                      9.5 →                      10.4 \*  
 beste Teiler: 91.0 (24.), 100.0 (26.), 129.6 (25.)  
 Trefferlage: 0.37 mm links, 0.02 mm tief  
 Streuwert: 2.22, horizontal: 2.34, vertikal: 2.09

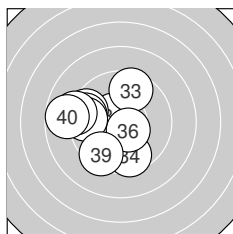

**Serie 4:**  
 10.5 \*                      9.5 ↖                      9.6 ↑                      9.6 ↓                      9.5 ←  
 10.5 \*                      9.5 ←                      9.1 ←                      9.4 ↙                      8.8 ←  
 beste Teiler: 103.9 (31.), 112.4 (36.), 346.6 (33.)  
 Trefferlage: 2.08 mm links, 0.03 mm hoch  
 Streuwert: 2.25, horizontal: 2.44, vertikal: 2.03



Ergebnis: **391.4** (373)  
 Serien: 98.1 96.9 97.3 99.1  
 Zähler: 14 25 1 0 0 0 0 0 0  
 Innenzehner: 11  
 Weitester: 608 (14.), 492 (11.), 455 (39.)  
 beste Teiler: 62.6 (28.), 81.4 (33.), 107.8 (31.)  
 Trefferlage: 0.10 mm links, 0.42 mm hoch  
 Streuwert: 2.24, horizontal: 2.44, vertikal: 2.02

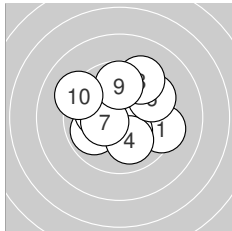
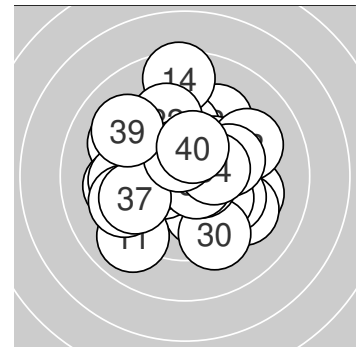

**Serie 1:**

9.3 →	10.3 *	9.9 ←	10.0 ↓	10.2 *
9.6 ↗	10.4 *	9.4 ↗	9.8 ↑	9.2 ↘

beste Teiler: 145.2 (7.), 152.0 (2.), 200.8 (5.)  
 Trefferlage: 0.10 mm rechts, 0.46 mm hoch  
 Streuwert: 2.25, horizontal: 2.48, vertikal: 1.99

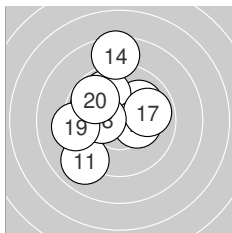

**Serie 2:**

9.0 ↙	10.0 ↗	9.9 ↘	8.5 ↑	10.3 *
9.9 ↘	9.9 →	10.3 *	9.3 ←	9.8 ↘

beste Teiler: 164.2 (18.), 166.7 (15.), 233.0 (12.)  
 Trefferlage: 0.91 mm links, 0.93 mm hoch  
 Streuwert: 2.39, horizontal: 2.27, vertikal: 2.50

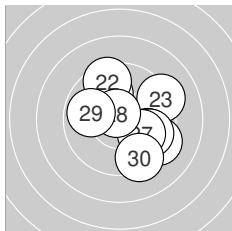

**Serie 3:**

9.9 ↘	9.5 ↑	9.2 →	9.3 →	9.8 →
9.7 →	10.0 →	10.7 *	9.9 ←	9.3 ↓

beste Teiler: 62.6 (28.), 243.7 (27.), 257.7 (21.)  
 Trefferlage: 1.16 mm rechts, 0.05 mm tief  
 Streuwert: 2.24, horizontal: 2.26, vertikal: 2.23

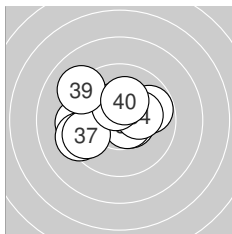

**Serie 4:**

10.5 *	9.8 →	10.6 *	10.2 *	9.4 ←
9.3 ←	9.6 ←	10.4 *	9.1 ↘	10.2 *

beste Teiler: 81.4 (33.), 107.8 (31.), 131.7 (38.)  
 Trefferlage: 0.77 mm links, 0.34 mm hoch  
 Streuwert: 2.04, horizontal: 2.52, vertikal: 1.39





Ergebnis: **402.7** (387)  
 Serien: 100.5 100.4 100.5 101.3  
 Zähler: 29 9 2 0 0 0 0 0 0  
 Innenzehner: 22  
 Weitester: 569 (26.), 505 (19.), 496 (5.)  
 beste Teiler: 65.2 (25.), 94.3 (21.), 94.4 (6.)  
 Trefferlage: 0.04 mm rechts, 0.36 mm hoch  
 Streuwert: 1.78, horizontal: 1.97, vertikal: 1.57

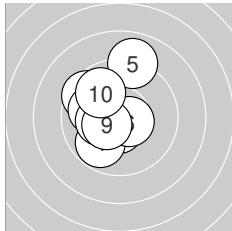
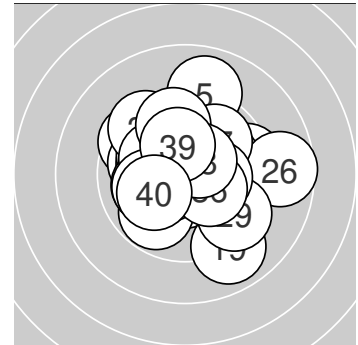

**Serie 1:**

10.5 *	9.5 ↘	10.6 *	9.8 ↙	9.0 ↑
10.6 *	10.0 ←	10.3 *	10.4 *	9.8 ↘

beste Teiler: 94.4 (6.), 98.0 (3.), 101.4 (1.)  
 Trefferlage: 1.06 mm links, 0.47 mm hoch  
 Streuwert: 1.72, horizontal: 1.35, vertikal: 2.03

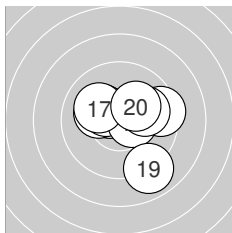

**Serie 2:**

9.4 →	10.2 *	10.5 *	10.2 *	10.4 *
10.5 *	10.1 ↘	10.0 →	8.9 ↘	10.2 *

beste Teiler: 106.8 (13.), 116.7 (16.), 143.6 (15.)  
 Trefferlage: 0.37 mm rechts, 0.24 mm hoch  
 Streuwert: 1.89, horizontal: 2.09, vertikal: 1.66

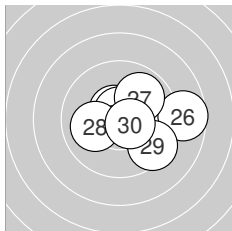

**Serie 3:**

10.6 *	10.5 *	10.0 →	10.2 *	10.7 *
8.7 →	9.9 ↗	10.0 ←	9.4 ↘	10.5 *

beste Teiler: 65.2 (25.), 94.3 (21.), 102.5 (30.)  
 Trefferlage: 1.37 mm rechts, 0.01 mm tief  
 Streuwert: 1.71, horizontal: 2.13, vertikal: 1.14

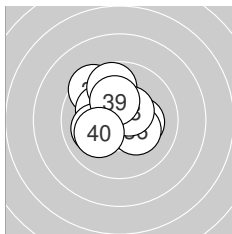

**Serie 4:**

10.2 *	9.5 ↘	10.2 *	10.5 *	10.1 ←
10.3 *	9.7 ↑	10.5 *	10.2 *	10.1 ←

beste Teiler: 114.1 (34.), 118.8 (38.), 172.1 (36.)  
 Trefferlage: 0.49 mm links, 0.73 mm hoch  
 Streuwert: 1.49, horizontal: 1.52, vertikal: 1.46



Ergebnis: **385.3** (370)  
 Serien: 95.3 95.3 97.9 96.8  
 Zähler: 19 12 9 0 0 0 0 0 0  
 Innenzehner: 11  
 Weitester: 739 (14.), 719 (10.), 649 (38.)  
 beste Teiler: 9.2 (13.), 55.2 (7.), 83.3 (29.)  
 Trefferlage: 0.64 mm links, 0.34 mm tief  
 Streuwert: 2.68, horizontal: 3.21, vertikal: 2.01

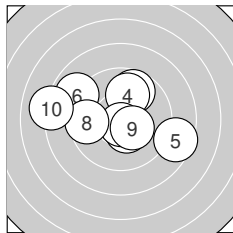
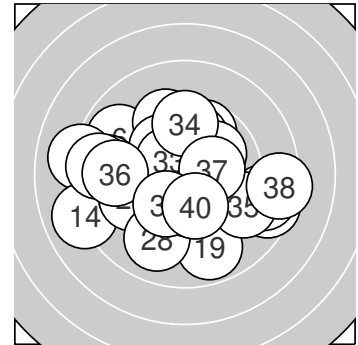

**Serie 1:**  
 9.7 ↗ 10.4 \* 9.0 ← 9.9 ↗ 8.6 →  
 8.9 ↘ 10.7 \* 9.6 ← 10.4 \* 8.1 ←  
 beste Teiler: 55.2 (7.), 135.9 (2.), 148.0 (9.)  
 Trefferlage: 1.02 mm links, 0.53 mm hoch  
 Streuwert: 2.95, horizontal: 3.79, vertikal: 1.76

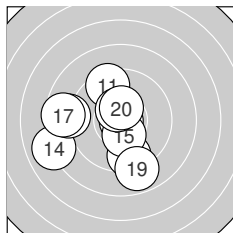

**Serie 2:**  
 9.4 ↘ 9.5 ↓ 10.9 \* 8.0 ← 10.3 \*  
 8.8 ← 8.6 ← 10.5 \* 8.9 ↓ 10.4 \*  
 beste Teiler: 9.2 (13.), 111.3 (18.), 127.2 (20.)  
 Trefferlage: 1.66 mm links, 0.61 mm tief  
 Streuwert: 2.86, horizontal: 3.11, vertikal: 2.58

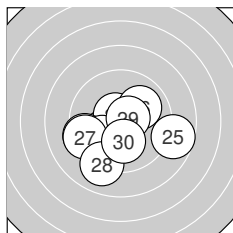

**Serie 3:**  
 10.1 ↙ 10.6 \* 9.4 ← 10.0 ↙ 8.7 →  
 10.0 ↗ 9.4 ← 9.0 ↓ 10.6 \* 10.1 ↓  
 beste Teiler: 83.3 (29.), 84.5 (22.), 207.1 (30.)  
 Trefferlage: 0.49 mm links, 1.15 mm tief  
 Streuwert: 2.26, horizontal: 2.75, vertikal: 1.62

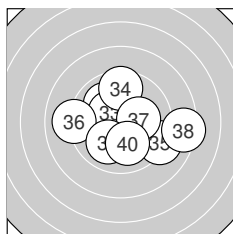

**Serie 4:**  
 10.1 ↘ 10.0 ↘ 10.4 \* 9.6 ↑ 9.1 →  
 9.0 ← 10.2 \* 8.4 → 10.0 ↓ 10.0 ↓  
 beste Teiler: 145.9 (33.), 186.9 (37.), 206.8 (31.)  
 Trefferlage: 0.60 mm rechts, 0.14 mm tief  
 Streuwert: 2.58, horizontal: 3.14, vertikal: 1.86



Ergebnis: **394.7** (378)  
 Serien: 97.3 99.6 98.1 99.7  
 Zähler: 20 18 2 0 0 0 0 0 0 0  
 Innenzehner: 11  
 Weitester: 575 (29.), 511 (27.), 493 (30.)  
 beste Teiler: 52.4 (25.), 61.9 (12.), 62.2 (37.)  
 Trefferlage: 0.38 mm rechts, 0.51 mm hoch  
 Streuwert: 2.13, horizontal: 2.02, vertikal: 2.23

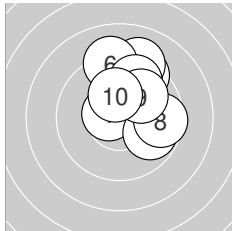
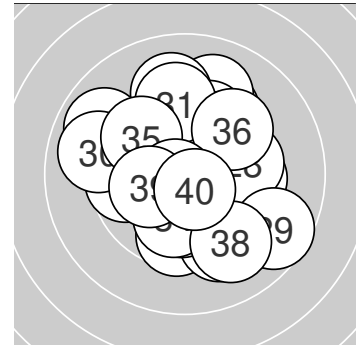

**Serie 1:**

10.6 *	9.8 ↘	9.4 ↗	9.1 ↗	9.8 ↗
9.1 ↑	9.7 ↗	9.6 →	10.0 ↗	10.2 *

beste Teiler: 93.6 (1.), 188.4 (10.), 248.9 (9.)  
 Trefferlage: 1.13 mm rechts, 2.02 mm hoch  
 Streuwert: 1.70, horizontal: 1.42, vertikal: 1.94

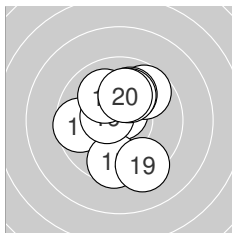

**Serie 2:**

9.6 ←	10.7 *	9.7 ↗	10.0 ↗	9.6 ↓
10.5 *	10.1 ↗	10.0 ↘	9.3 ↘	10.1 ↗

beste Teiler: 61.9 (12.), 108.5 (16.), 211.0 (20.)  
 Trefferlage: 0.01 mm rechts, 0.40 mm hoch  
 Streuwert: 1.96, horizontal: 1.59, vertikal: 2.27

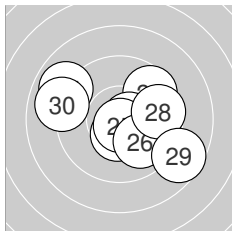

**Serie 3:**

9.6 ↗	10.5 *	10.5 *	10.6 *	10.7 *
10.0 ↘	8.9 ↘	9.6 →	8.7 ↘	9.0 ←

beste Teiler: 52.4 (25.), 79.0 (24.), 108.0 (22.)  
 Trefferlage: 0.44 mm rechts, 0.08 mm tief  
 Streuwert: 2.51, horizontal: 3.08, vertikal: 1.76

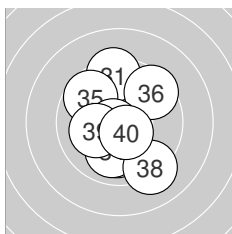

**Serie 4:**

9.4 ↑	10.6 *	10.0 ↓	10.0 ↓	9.7 ↘
9.5 ↗	10.7 *	9.1 ↘	10.1 ←	10.6 *

beste Teiler: 62.2 (37.), 99.8 (32.), 100.7 (40.)  
 Trefferlage: 0.06 mm links, 0.28 mm tief  
 Streuwert: 2.06, horizontal: 1.64, vertikal: 2.41



Ergebnis: **404.7** (386)  
 Serien: 100.6 101.8 99.0 103.3  
 Zähler: 26 14 0 0 0 0 0 0 0 0  
 Innenzehner: 20  
 Weitestе: 451 (26.), 431 (9.), 399 (15.)  
 beste Teiler: 9.0 (36.), 26.6 (37.), 50.2 (11.)  
 Trefferlage: 0.08 mm rechts, 0.79 mm hoch  
 Streuwert: 1.61, horizontal: 1.80, vertikal: 1.40

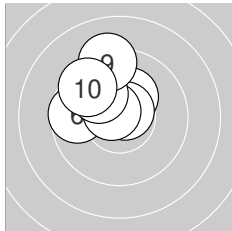
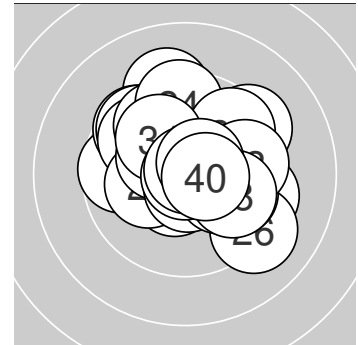

**Serie 1:**

10.3 *	10.1 ↘	10.7 *	10.0 ↘	10.4 *
9.7 ←	10.6 *	10.0 ↘	9.2 ↑	9.6 ↘

beste Teiler: 63.8 (3.), 77.0 (7.), 136.3 (5.)  
 Trefferlage: 1.25 mm links, 1.45 mm hoch  
 Streuwert: 1.20, horizontal: 1.22, vertikal: 1.17

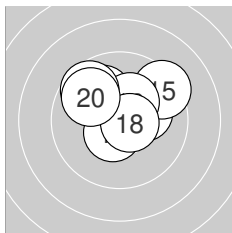

**Serie 2:**

10.8 *	10.2 *	10.0 ↘	10.5 *	9.4 ↗
10.3 *	10.5 *	10.6 *	9.7 ↘	9.8 ↘

beste Teiler: 50.2 (11.), 80.5 (18.), 107.4 (17.)  
 Trefferlage: 0.00 mm, 1.06 mm hoch  
 Streuwert: 1.46, horizontal: 1.75, vertikal: 1.11

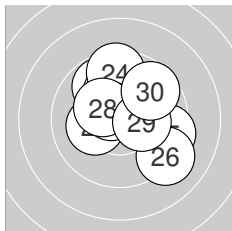

**Serie 3:**

10.2 *	9.8 ↘	10.1 ↑	9.5 ↑	9.4 →
9.1 ↘	10.6 *	10.3 *	10.3 *	9.7 ↗

beste Teiler: 87.7 (27.), 157.2 (28.), 172.4 (29.)  
 Trefferlage: 0.51 mm rechts, 0.71 mm hoch  
 Streuwert: 2.01, horizontal: 2.09, vertikal: 1.94

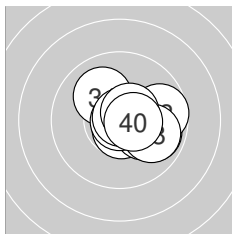

**Serie 4:**

9.9 →	10.7 *	9.7 →	10.1 ↘	10.2 *
10.9 *	10.8 *	9.9 →	10.6 *	10.5 *

beste Teiler: 9.0 (36.), 26.6 (37.), 73.3 (32.)  
 Trefferlage: 1.06 mm rechts, 0.05 mm tief  
 Streuwert: 1.16, horizontal: 1.38, vertikal: 0.89



Ergebnis: **389.1** (369)  
 Serien: 101.3 95.0 94.7 98.1  
 Zähler: 18 15 5 2 0 0 0 0 0 0  
 Innenzehner: 12  
 Weitester: 842 (19.), 813 (27.), 617 (29.)  
 beste Teiler: 56.7 (4.), 69.0 (38.), 72.9 (2.)  
 Trefferlage: 0.52 mm rechts, 0.38 mm hoch  
 Streuwert: 2.52, horizontal: 2.78, vertikal: 2.24

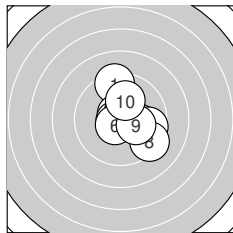
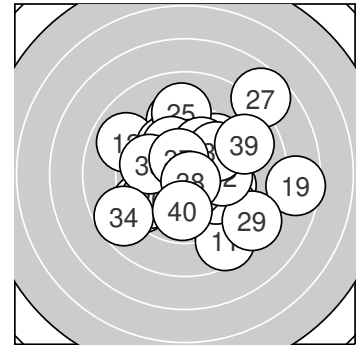

**Serie 1:**

9.3 ↑	10.7 *	10.1 →	10.7 *	10.6 *
10.6 *	9.7 →	9.3 ↘	10.2 *	10.1 ↑

beste Teiler: 56.7 (4.), 72.9 (2.), 89.1 (6.)  
 Trefferlage: 0.90 mm rechts, 0.23 mm hoch  
 Streuwert: 1.70, horizontal: 1.56, vertikal: 1.82

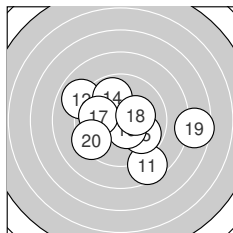

**Serie 2:**

8.6 ↘	8.9 ↘	10.2 *	9.9 ↑	9.8 ↘
10.5 *	9.9 ←	10.2 *	7.6 →	9.4 ↙

beste Teiler: 119.0 (16.), 178.3 (18.), 194.7 (13.)  
 Trefferlage: 0.31 mm rechts, 0.39 mm tief  
 Streuwert: 3.12, horizontal: 3.78, vertikal: 2.27

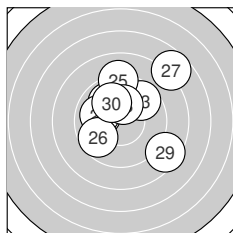

**Serie 3:**

9.9 ↘	10.0 ←	9.6 ↗	10.0 ←	9.1 ↑
9.7 ↙	7.7 ↗	10.2 *	8.5 ↘	10.0 ↑

beste Teiler: 190.3 (28.), 231.1 (22.), 233.9 (30.)  
 Trefferlage: 0.35 mm rechts, 1.48 mm hoch  
 Streuwert: 2.90, horizontal: 3.04, vertikal: 2.74

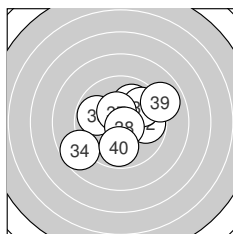

**Serie 4:**

10.2 *	9.8 →	9.8 ←	8.7 ↙	10.0 ↗
9.8 ↗	10.4 *	10.7 *	8.9 ↗	9.8 ↓

beste Teiler: 69.0 (38.), 127.9 (37.), 199.0 (31.)  
 Trefferlage: 0.52 mm rechts, 0.22 mm hoch  
 Streuwert: 2.33, horizontal: 2.69, vertikal: 1.90



Ergebnis: **407.9** (391)  
 Serien: 99.1 103.7 103.0 102.1  
 Zähler: 31 9 0 0 0 0 0 0 0  
 Innenzehner: 25  
 Weitestе: 500 (3.), 470 (35.), 361 (7.)  
 beste Teiler: 5.3 (20.), 25.7 (38.), 65.7 (26.)  
 Trefferlage: 0.12 mm rechts, 0.17 mm hoch  
 Streuwert: 1.56, horizontal: 1.67, vertikal: 1.43

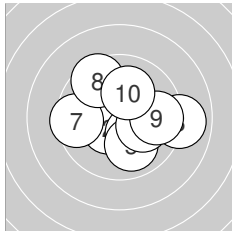
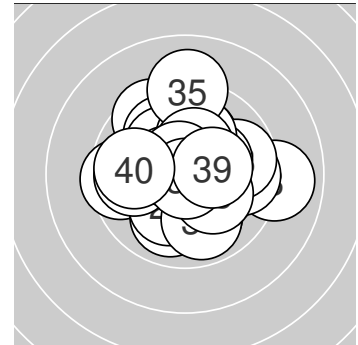

**Serie 1:**

10.5 *	10.4 *	9.0 →	10.3 *	10.0 ↘
10.1 ↘	9.5 ←	9.5 ↖	9.7 →	10.1 ↑

beste Teiler: 122.4 (1.), 126.1 (2.), 168.8 (4.)  
 Trefferlage: 0.53 mm rechts, 0.00 mm  
 Streuwert: 2.08, horizontal: 2.49, vertikal: 1.58

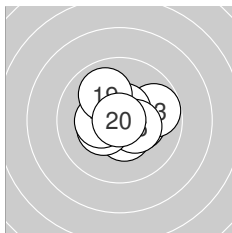

**Serie 2:**

10.3 *	10.5 *	9.8 →	10.6 *	10.5 *
10.4 *	10.4 *	10.3 *	10.0 ↖	10.9 *

beste Teiler: 5.3 (20.), 91.7 (14.), 124.5 (15.)  
 Trefferlage: 0.12 mm rechts, 0.15 mm hoch  
 Streuwert: 1.24, horizontal: 1.47, vertikal: 0.95

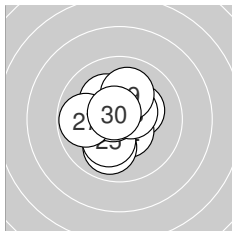

**Serie 3:**

10.3 *	10.5 *	10.2 *	10.0 ↙	10.2 *
10.7 *	9.8 ←	10.5 *	10.1 ↑	10.7 *

beste Teiler: 65.7 (26.), 68.7 (30.), 111.5 (28.)  
 Trefferlage: 0.29 mm links, 0.06 mm hoch  
 Streuwert: 1.33, horizontal: 1.26, vertikal: 1.40

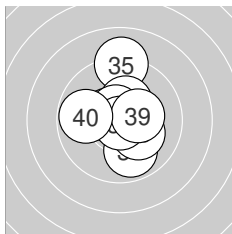

**Serie 4:**

9.9 ↘	10.5 *	10.2 *	10.5 *	9.1 ↑
10.3 *	10.6 *	10.9 *	10.3 *	9.8 ←

beste Teiler: 25.7 (38.), 76.9 (37.), 105.6 (32.)  
 Trefferlage: 0.14 mm rechts, 0.48 mm hoch  
 Streuwert: 1.60, horizontal: 1.31, vertikal: 1.85



Ergebnis: **404.5** (384)  
 Serien: 101.2 101.7 100.9 100.7  
 Zähler: 25 14 1 0 0 0 0 0 0  
 Innenzehner: 23  
 Weitester: 592 (27.), 483 (25.), 416 (5.)  
 beste Teiler: 28.0 (7.), 29.1 (26.), 34.9 (23.)  
 Trefferlage: 0.28 mm links, 0.24 mm hoch  
 Streuwert: 1.74, horizontal: 2.10, vertikal: 1.27

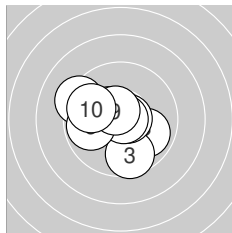
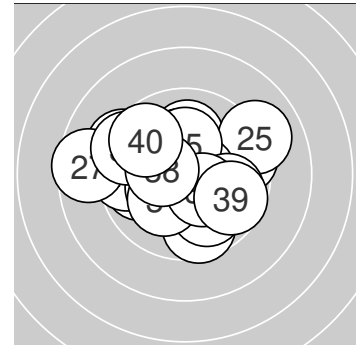

**Serie 1:**

10.3 *	9.9 ↘	9.6 ↓	10.7 *	9.3 ↖
10.4 *	10.8 *	9.8 ←	10.6 *	9.8 ↖

beste Teiler: 28.0 (7.), 65.1 (4.), 92.7 (9.)  
 Trefferlage: 0.56 mm links, 0.18 mm tief  
 Streuwert: 1.72, horizontal: 1.97, vertikal: 1.42

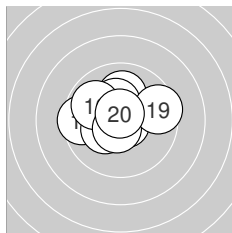

**Serie 2:**

10.2 *	9.5 ←	10.3 *	10.0 ↑	10.3 *
9.9 ↖	10.7 *	10.6 *	9.5 →	10.7 *

beste Teiler: 51.6 (17.), 61.5 (20.), 82.3 (18.)  
 Trefferlage: 0.55 mm links, 0.62 mm hoch  
 Streuwert: 1.51, horizontal: 1.86, vertikal: 1.06

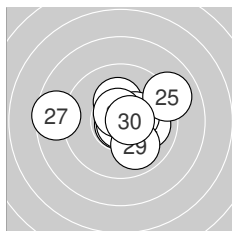

**Serie 3:**

10.2 *	10.0 →	10.8 *	10.4 *	9.0 ↗
10.8 *	8.6 ←	10.6 *	9.9 ↘	10.6 *

beste Teiler: 29.1 (26.), 34.9 (23.), 80.9 (28.)  
 Trefferlage: 0.36 mm rechts, 0.27 mm hoch  
 Streuwert: 2.04, horizontal: 2.62, vertikal: 1.22

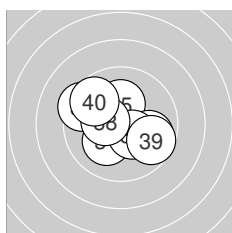

**Serie 4:**

10.2 *	10.7 *	10.2 *	9.4 ↖	10.2 *
9.8 ↘	10.4 *	10.4 *	9.7 ↘	9.7 ↖

beste Teiler: 57.6 (32.), 142.7 (38.), 143.7 (37.)  
 Trefferlage: 0.39 mm links, 0.25 mm hoch  
 Streuwert: 1.77, horizontal: 2.06, vertikal: 1.41



Ergebnis: **404.9** (387)  
 Serien: 103.1 100.3 101.4 100.1  
 Zähler: 27 13 0 0 0 0 0 0 0 0  
 Innenzehner: 21  
 Weitestе: 495 (30.), 450 (39.), 424 (16.)  
 beste Teiler: 41.8 (10.), 48.1 (38.), 72.2 (1.)  
 Trefferlage: 0.06 mm links, 0.30 mm tief  
 Streuwert: 1.72, horizontal: 2.05, vertikal: 1.31

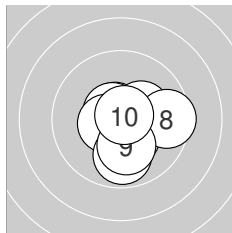
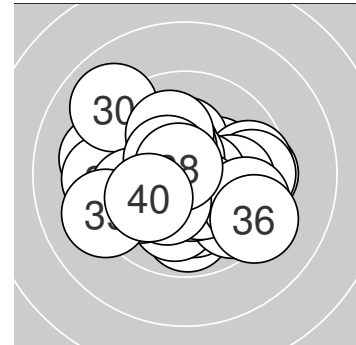

**Serie 1:**  
 10.7 \*                      10.6 \*                      10.3 \*                      10.3 \*                      10.4 \*  
 10.5 \*                      9.9 ↓                      9.5 →                      10.1 ↓                      10.8 \*  
 beste Teiler: 41.8 (10.), 72.2 (1.), 83.6 (2.)  
 Trefferlage: 0.50 mm rechts, 0.55 mm tief  
 Streuwert: 1.25, horizontal: 1.30, vertikal: 1.21

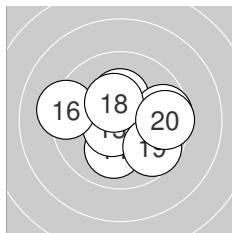

**Serie 2:**  
 10.1 ↘                      10.6 \*                      10.3 \*                      10.1 ↓                      10.6 \*  
 9.3 ←                      9.6 →                      10.4 \*                      9.7 ↘                      9.6 →  
 beste Teiler: 83.8 (15.), 86.8 (12.), 142.4 (18.)  
 Trefferlage: 0.42 mm rechts, 0.09 mm tief  
 Streuwert: 1.89, horizontal: 2.33, vertikal: 1.30

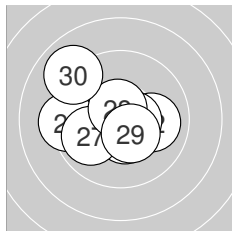

**Serie 3:**  
 10.6 \*                      10.0 →                      10.5 \*                      9.3 ←                      10.6 \*  
 10.5 \*                      9.9 ←                      10.6 \*                      10.4 \*                      9.0 ↘  
 beste Teiler: 84.2 (28.), 90.7 (25.), 97.5 (21.)  
 Trefferlage: 0.62 mm links, 0.10 mm tief  
 Streuwert: 1.77, horizontal: 2.09, vertikal: 1.37

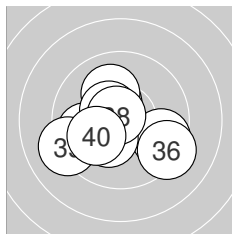

**Serie 4:**  
 10.4 \*                      10.1 ↖                      9.8 ←                      10.5 \*                      9.6 →  
 9.3 ↘                      10.3 \*                      10.8 \*                      9.2 ←                      10.1 ←  
 beste Teiler: 48.1 (38.), 115.7 (34.), 145.8 (31.)  
 Trefferlage: 0.54 mm links, 0.47 mm tief  
 Streuwert: 1.94, horizontal: 2.32, vertikal: 1.47





**Ergebnis:** **376.8** (356)  
**Serien:** 96.0 95.9 85.8 99.1  
**Zähler:** 13 16 7 3 0 1 0 0 0 0  
**Innenzehner:** 9  
**Weiteste:** 1370 (24.), 904 (29.), 825 (11.)  
**beste Teiler:** 50.0 (13.), 92.1 (31.), 115.4 (8.)  
**Trefferlage:** 0.22 mm links, 0.30 mm tief  
**Streuwert:** 3.29, horizontal: 3.99, vertikal: 2.39

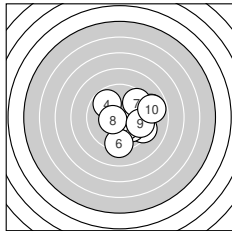
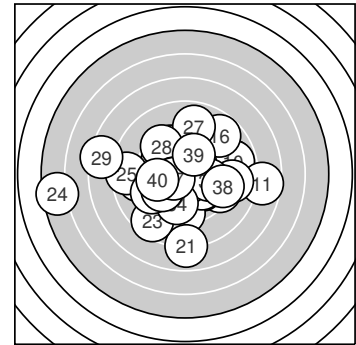

**Serie 1:**  
 9.3 ↘                      10.0 ↘                      8.9 →                      9.8 ↘                      10.3 \*  
 9.3 ↓                      9.5 ↗                      10.5 \*                      9.6 →                      8.8 →

**beste Teiler:** 115.4 (8.), 167.0 (5.), 246.2 (2.)  
**Trefferlage:** 1.94 mm rechts, 0.31 mm tief  
**Streuwert:** 2.28, horizontal: 2.46, vertikal: 2.08

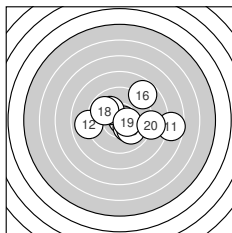

**Serie 2:**  
 7.7 →                      9.0 ←                      10.8 \*                      10.3 \*                      10.0 ↘  
 8.8 ↗                      10.1 ↘                      9.8 ↘                      10.5 \*                      8.9 →

**beste Teiler:** 50.0 (13.), 124.9 (19.), 165.5 (14.)  
**Trefferlage:** 1.27 mm rechts, 0.17 mm hoch  
**Streuwert:** 2.93, horizontal: 3.76, vertikal: 1.72

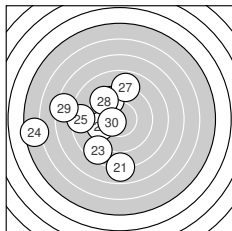

**Serie 3:**  
 7.9 ↓                      9.7 ←                      8.6 ↙                      5.5 ←                      8.5 ←  
 9.6 ↘                      8.9 ↑                      9.4 ↘                      7.3 ←                      10.4 \*

**beste Teiler:** 129.0 (30.), 322.0 (22.), 332.3 (26.)  
**Trefferlage:** 3.91 mm links, 0.33 mm tief  
**Streuwert:** 4.16, horizontal: 4.45, vertikal: 3.85

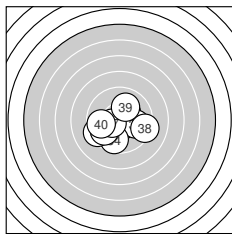

**Serie 4:**  
 10.6 \*                      10.3 \*                      9.9 →                      9.7 ↓                      9.3 ←  
 9.8 ↙                      10.4 \*                      9.3 →                      10.0 ↑                      9.8 ←

**beste Teiler:** 92.1 (31.), 129.6 (37.), 157.6 (32.)  
**Trefferlage:** 0.19 mm links, 0.74 mm tief  
**Streuwert:** 2.02, horizontal: 2.44, vertikal: 1.48



Ergebnis: **403.4** (387)  
 Serien: 101.5 99.3 101.6 101.0  
 Zähler: 27 13 0 0 0 0 0 0 0 0  
 Innenzehner: 17  
 Weitestе: 398 (33.), 371 (2.), 370 (7.)  
 beste Teiler: 57.0 (37.), 98.0 (4.), 105.0 (8.)  
 Trefferlage: 0.03 mm rechts, 0.05 mm tief  
 Streuwert: 1.69, horizontal: 1.90, vertikal: 1.44

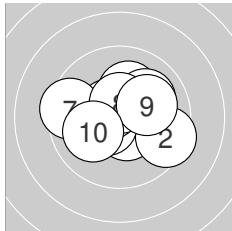
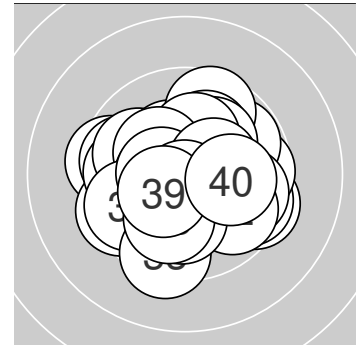

**Serie 1:**

10.5 *	9.5 ↘	10.5 *	10.6 *	10.2 *
10.0 ↗	9.5 ←	10.5 *	10.1 ↗	10.1 ←

beste Teiler: 98.0 (4.), 105.0 (8.), 109.6 (1.)  
 Trefferlage: 0.11 mm rechts, 0.23 mm hoch  
 Streuwert: 1.67, horizontal: 2.07, vertikal: 1.15

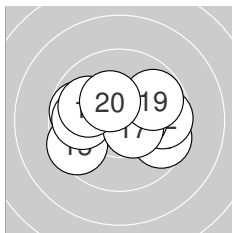

**Serie 2:**

9.6 ↘	9.7 →	9.7 ←	10.4 *	9.5 ←
9.8 ←	10.5 *	10.0 ↘	9.8 ↗	10.3 *

beste Teiler: 113.6 (17.), 129.0 (14.), 156.9 (20.)  
 Trefferlage: 0.08 mm links, 0.12 mm hoch  
 Streuwert: 1.98, horizontal: 2.58, vertikal: 1.09

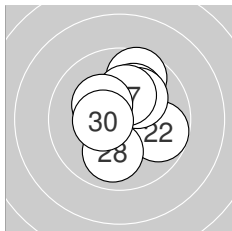

**Serie 3:**

9.6 ↗	9.8 ↘	10.1 ↗	10.5 *	10.5 *
10.1 ↗	10.2 *	10.0 ↓	10.3 *	10.5 *

beste Teiler: 116.1 (24.), 119.4 (25.), 123.4 (30.)  
 Trefferlage: 0.18 mm rechts, 0.66 mm hoch  
 Streuwert: 1.50, horizontal: 1.42, vertikal: 1.57

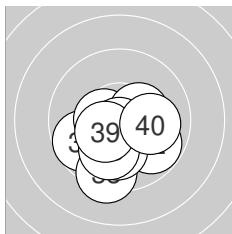

**Serie 4:**

9.7 ←	9.8 ↘	9.4 ↓	10.5 *	10.1 ↓
10.4 *	10.7 *	10.0 ↓	10.4 *	10.0 →

beste Teiler: 57.0 (37.), 115.1 (34.), 136.4 (39.)  
 Trefferlage: 0.08 mm links, 1.25 mm tief  
 Streuwert: 1.47, horizontal: 1.63, vertikal: 1.30



Ergebnis: **404.2** (385)  
 Serien: 100.7 102.2 101.0 100.3  
 Zähler: 26 13 1 0 0 0 0 0 0 0  
 Innenzehner: 20  
 Weitestе: 512 (40.), 371 (38.), 363 (9.)  
 beste Teiler: 48.1 (28.), 61.0 (1.), 91.4 (16.)  
 Trefferlage: 0.12 mm rechts, 0.32 mm hoch  
 Streuwert: 1.67, horizontal: 1.83, vertikal: 1.50

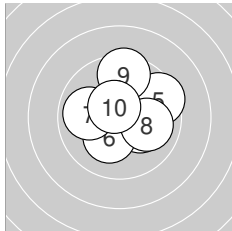
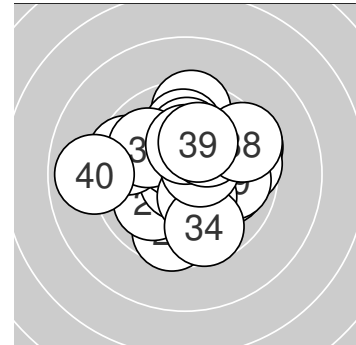

**Serie 1:**

10.7 *	10.1 ↗	10.2 *	10.0 ↗	9.5 ↗
10.2 *	9.9 ←	10.0 →	9.5 ↑	10.6 *

beste Teiler: 61.0 (1.), 99.2 (10.), 185.6 (6.)  
 Trefferlage: 0.69 mm rechts, 0.64 mm hoch  
 Streuwert: 1.64, horizontal: 1.78, vertikal: 1.48

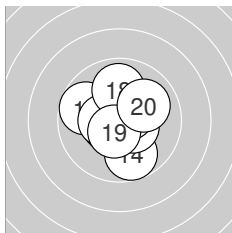

**Serie 2:**

10.3 *	10.5 *	9.7 ↖	9.8 ↓	10.5 *
10.6 *	10.4 *	9.9 ↑	10.5 *	10.0 ↗

beste Teiler: 91.4 (16.), 102.4 (12.), 106.4 (19.)  
 Trefferlage: 0.14 mm links, 0.19 mm hoch  
 Streuwert: 1.46, horizontal: 1.42, vertikal: 1.51

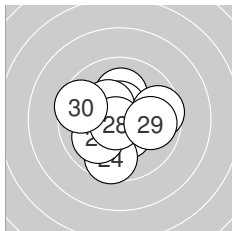

**Serie 3:**

10.1 ↑	10.6 *	10.4 *	9.6 ↓	10.0 ↗
10.4 *	9.6 →	10.8 *	9.9 →	9.6 ↖

beste Teiler: 48.1 (28.), 99.0 (22.), 126.1 (23.)  
 Trefferlage: 0.06 mm links, 0.07 mm tief  
 Streuwert: 1.76, horizontal: 1.92, vertikal: 1.57

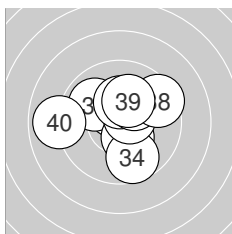

**Serie 4:**

10.6 *	9.9 ↖	10.4 *	9.7 ↓	10.6 *
10.3 *	10.2 *	9.5 ↗	10.2 *	8.9 ←

beste Teiler: 94.8 (35.), 100.6 (31.), 144.9 (33.)  
 Trefferlage: 0.02 mm rechts, 0.53 mm hoch  
 Streuwert: 1.95, horizontal: 2.26, vertikal: 1.58



Ergebnis: **0.0** (0)<sub>,DNS</sub>  
Serien:  
Zähler: 0 0 0 0 0 0 0 0 0 0  
Innenzehner: 0  
Weiteste:  
~~beste Teile~~<sub>nicht gestartet</sub>  
Trefferlage: 0.00 mm , 0.00 mm  
Streuwert:

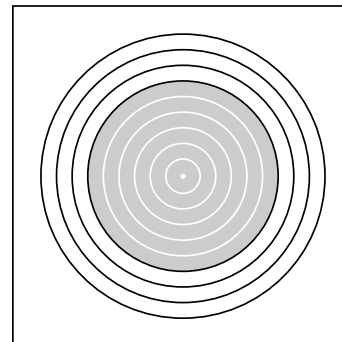

Ergebnis: **412.7** (394)  
 Serien: 103.7 102.0 103.5 103.5  
 Zähler: 34 6 0 0 0 0 0 0 0 0  
 Innenzehner: 28  
 Weitestе: 459 (14.), 395 (40.), 392 (2.)  
 beste Teiler: 14.8 (28.), 36.6 (8.), 37.0 (13.)  
 Trefferlage: 0.09 mm rechts, 0.51 mm hoch  
 Streuwert: 1.30, horizontal: 1.47, vertikal: 1.12

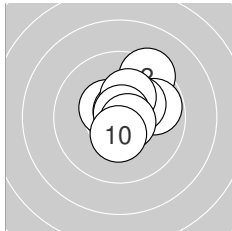
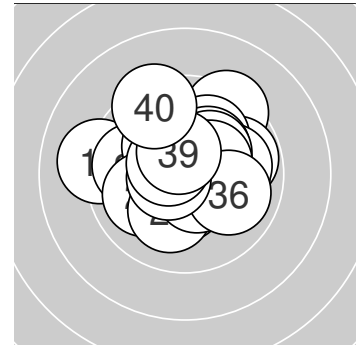

**Serie 1:**

10.8 *	9.4 ↗	10.5 *	10.8 *	9.8 →
10.2 *	10.3 *	10.8 *	10.7 *	10.4 *

beste Teiler: 36.6 (8.), 41.4 (1.), 50.6 (4.)  
 Trefferlage: 0.69 mm rechts, 0.70 mm hoch  
 Streuwert: 1.17, horizontal: 1.13, vertikal: 1.21

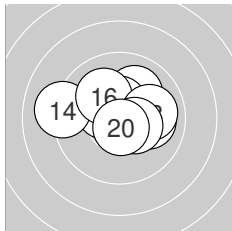

**Serie 2:**

10.0 ↗	10.4 *	10.8 *	9.1 ←	10.5 *
10.1 ↘	10.0 →	10.0 →	10.4 *	10.7 *

beste Teiler: 37.0 (13.), 73.8 (20.), 112.1 (15.)  
 Trefferlage: 0.04 mm rechts, 0.49 mm hoch  
 Streuwert: 1.58, horizontal: 2.04, vertikal: 0.92

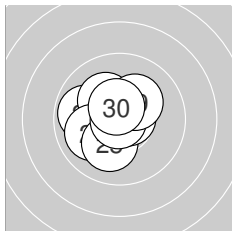

**Serie 3:**

10.3 *	9.9 ←	10.2 *	10.0 ↙	10.1 ↘
10.7 *	10.7 *	10.9 *	10.2 *	10.5 *

beste Teiler: 14.8 (28.), 65.9 (27.), 69.3 (26.)  
 Trefferlage: 0.56 mm links, 0.29 mm hoch  
 Streuwert: 1.18, horizontal: 1.25, vertikal: 1.11

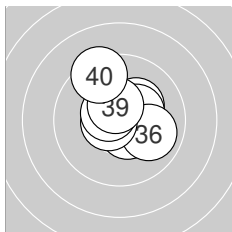

**Serie 4:**

10.8 *	10.5 *	10.3 *	10.6 *	10.4 *
9.9 ↘	10.6 *	10.5 *	10.5 *	9.4 ↖

beste Teiler: 45.8 (31.), 88.0 (37.), 94.0 (34.)  
 Trefferlage: 0.21 mm rechts, 0.56 mm hoch  
 Streuwert: 1.27, horizontal: 1.21, vertikal: 1.33



Ergebnis: **376.6** (362)  
 Serien: 92.5 91.8 98.6 93.7  
 Zähler: 15 15 7 3 0 0 0 0 0 0  
 Innenzehner: 10  
 Weitestе: 853 (7.), 789 (1.), 776 (11.)  
 beste Teiler: 43.1 (29.), 95.0 (23.), 124.7 (15.)  
 Trefferlage: 0.19 mm rechts, 0.36 mm hoch  
 Streuwert: 3.09, horizontal: 3.79, vertikal: 2.19

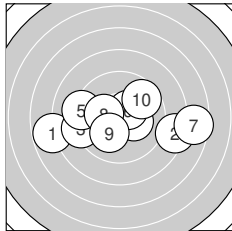
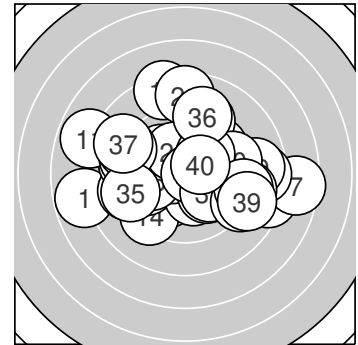

**Serie 1:**

7.8 ←	8.3 →	9.1 ←	10.3 *	9.2 ←
10.4 *	7.5 →	10.2 *	10.1 ↘	9.6 ↗

beste Teiler: 128.3 (6.), 168.4 (4.), 182.9 (8.)  
 Trefferlage: 0.05 mm rechts, 0.39 mm tief  
 Streuwert: 3.66, horizontal: 4.99, vertikal: 1.36

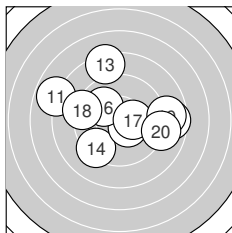

**Serie 2:**

7.8 ↖	8.6 →	8.3 ↑	9.3 ↘	10.5 *
10.0 ↘	10.3 *	9.2 ←	8.8 →	9.0 →

beste Teiler: 124.7 (15.), 151.0 (17.), 238.2 (16.)  
 Trefferlage: 0.07 mm rechts, 0.72 mm hoch  
 Streuwert: 3.60, horizontal: 4.39, vertikal: 2.57

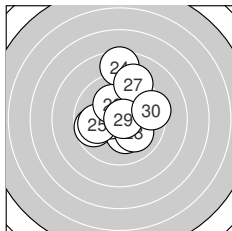

**Serie 3:**

9.7 ←	10.2 *	10.6 *	8.5 ↑	9.9 ←
10.2 *	9.2 ↗	10.1 ↘	10.8 *	9.4 →

beste Teiler: 43.1 (29.), 95.0 (23.), 181.0 (22.)  
 Trefferlage: 0.06 mm rechts, 0.82 mm hoch  
 Streuwert: 2.26, horizontal: 1.99, vertikal: 2.50

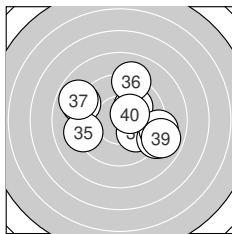

**Serie 4:**

10.0 ↘	10.1 ↗	9.0 ↖	9.1 ↘	9.2 ←
9.1 ↗	8.8 ↖	9.1 →	8.9 ↘	10.4 *

beste Teiler: 137.3 (40.), 217.8 (32.), 233.0 (31.)  
 Trefferlage: 0.60 mm rechts, 0.28 mm hoch  
 Streuwert: 3.07, horizontal: 3.72, vertikal: 2.23



Ergebnis: **399.8** (378)  
 Serien: 98.2 100.3 101.4 99.9  
 Zähler: 18 22 0 0 0 0 0 0 0  
 Innenzehner: 14  
 Weitesten: 391 (20.), 377 (10.), 357 (3.)  
 beste Teiler: 54.2 (28.), 61.6 (16.), 65.0 (11.)  
 Trefferlage: 0.50 mm rechts, 0.00 mm  
 Streuwert: 1.81, horizontal: 2.23, vertikal: 1.26

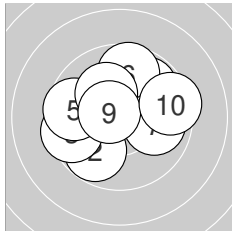
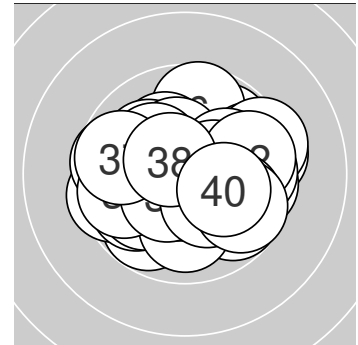

**Serie 1:**

9.7 ←	9.8 ↙	9.5 ←	9.8 ↗	9.6 ←
9.7 ↑	9.9 →	10.2 *	10.6 *	9.4 →

beste Teiler: 82.7 (9.), 194.3 (8.), 253.5 (7.)  
 Trefferlage: 0.46 mm links, 0.45 mm hoch  
 Streuwert: 2.13, horizontal: 2.55, vertikal: 1.62

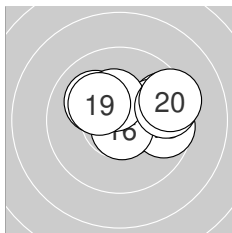

**Serie 2:**

10.7 *	9.6 →	10.1 ↘	9.9 →	9.7 →
10.7 *	10.4 *	9.6 →	10.2 *	9.4 →

beste Teiler: 61.6 (16.), 65.0 (11.), 149.7 (17.)  
 Trefferlage: 1.28 mm rechts, 0.68 mm hoch  
 Streuwert: 1.59, horizontal: 2.09, vertikal: 0.82

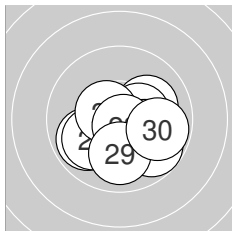

**Serie 3:**

9.9 ←	10.1 →	10.4 *	10.2 *	10.0 ←
10.5 *	9.8 ↘	10.7 *	10.0 ↓	9.8 →

beste Teiler: 54.2 (28.), 108.3 (26.), 141.1 (23.)  
 Trefferlage: 0.52 mm rechts, 0.74 mm tief  
 Streuwert: 1.48, horizontal: 1.79, vertikal: 1.09

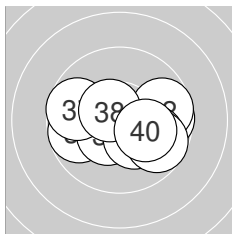

**Serie 4:**

9.7 →	9.7 →	9.7 ←	10.4 *	9.9 ↘
10.3 *	9.7 ←	10.6 *	9.7 ↘	10.2 *

beste Teiler: 98.2 (38.), 131.8 (34.), 165.4 (36.)  
 Trefferlage: 0.66 mm rechts, 0.41 mm tief  
 Streuwert: 1.81, horizontal: 2.38, vertikal: 0.92

