

Ergebnis:	<b>390.8</b>	(374)
Serien:	97.7	99.0 96.9 97.2
Zähler:	16	23 0 1 0 0 0 0 0 0
Innenzehner:	8	
weiteste:	752	(28), 489 (36), 471 (21)
beste Teiler	85.4	(15.) 140.0 (20.) 142.9 (33.)
Trefferlage	0.24 mm	rechts, 1.30 mm hoch
Streuwert	2.10,	horizontal: 2.63, vertikal: 1.36

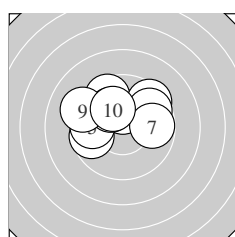

Serie 1:	9.7 ←	10.3 *	9.6 ↖	9.5 ↗	9.7 ←
	9.7 ↗	9.8 →	10.1 ↖	9.2 ↖	10.1 ↖
beste Teiler	154.0	(2.) 207.5 (10.)	211.3 (8.)		
Trefferlage	0.54 mm	links, 1.34 mm hoch			
Streuwert	2.00,	horizontal: 2.57, vertikal: 1.20			

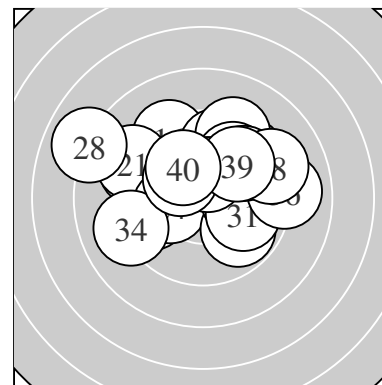
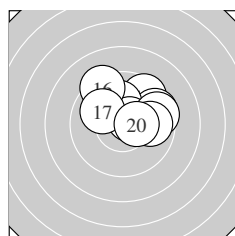

Serie 2:	10.0 ↗	9.6 ↗	9.6 →	10.1 ↑	10.6 *
	9.3 ↖	10.0 ↖	9.5 →	9.9 →	10.4 *
beste Teiler	85.4	(15.) 140.0 (20.)	214.5 (14.)		
Trefferlage	1.09 mm	rechts, 1.41 mm hoch			
Streuwert	1.63,	horizontal: 1.99, vertikal: 1.16			

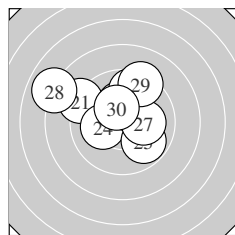

Serie 3:	9.1 ↖	10.2 *	9.7 ↑	10.1 ←	9.8 ↘
	10.4 *	10.1 →	7.9 ↖	9.3 ↑	10.3 *
beste Teiler	145.3	(26.) 156.0 (30.)	184.9 (22.)		
Trefferlage	0.67 mm	links, 1.44 mm hoch			
Streuwert	2.42,	horizontal: 2.92, vertikal: 1.79			

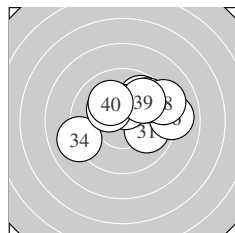

Serie 4:	9.9 ↘	9.8 ↗	10.4 *	9.1 ←	10.2 *
	9.0 →	9.7 ↗	9.2 →	9.8 ↗	10.1 ↖
beste Teiler	142.9	(33.) 178.7 (35.)	217.1 (40.)		
Trefferlage	1.10 mm	rechts, 1.03 mm hoch			
Streuwert	2.20,	horizontal: 2.78, vertikal: 1.40			

Unterschrift des Schützen

Meyton Elektronik

Ergebnis: **405.2** (384)  
 Serien: 103.5 101.1 99.3 101.3  
 Zähler: 25 14 1 0 0 0 0 0 0 0  
 Innenzehner: 20  
 weiteste: 639 (17), 471 (29), 409 (21)  
 beste Teiler 21.0 (4.) 33.4 (18.) 42.2 (12.)  
 Trefferlage 0.29 mm links, 0.16 mm tief  
 Streuwert 1.71, horizontal: 1.92, vertikal: 1.48

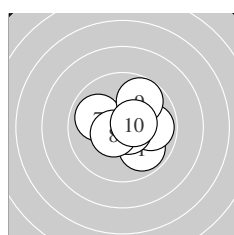
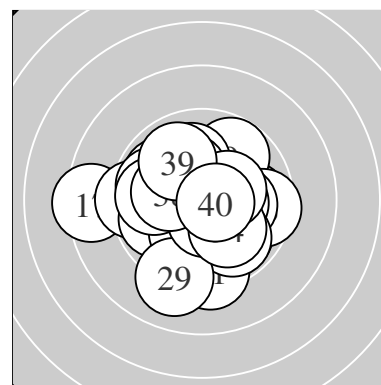

Serie 1:  
 9.9 ↘ 10.7 \* 9.9 → 10.9 \* 10.7 \*  
 10.7 \* 9.9 ↙ 10.5 \* 9.8 ↗ 10.5 \*  
 beste Teiler 21.0 (4.) 65.0 (5.) 66.5 (6.)  
 Trefferlage 0.46 mm rechts, 0.12 mm hoch  
 Streuwert 1.32, horizontal: 1.48, vertikal: 1.13

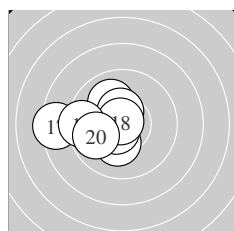

Serie 2:  
 10.6 \* 10.8 \* 10.0 ↖ 10.5 \* 10.2 \*  
 10.6 \* 8.4 ← 10.8 \* 9.4 ← 9.8 ↙  
 beste Teiler 33.4 (18.) 42.2 (12.) 88.4 (16.)  
 Trefferlage 1.66 mm links, 0.00 mm  
 Streuwert 1.64, horizontal: 2.05, vertikal: 1.09

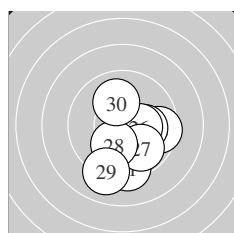

Serie 3:  
 9.3 ↓ 10.7 \* 9.5 → 10.1 → 10.4 \*  
 10.3 \* 9.8 ↘ 10.1 ↓ 9.1 ↓ 10.0 ↖  
 beste Teiler 68.6 (22.) 141.5 (25.) 160.0 (26.)  
 Trefferlage 0.81 mm rechts, 1.24 mm tief  
 Streuwert 1.76, horizontal: 1.53, vertikal: 1.97

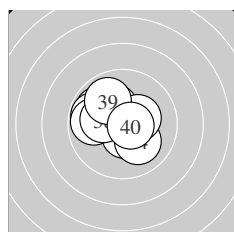

Serie 4:  
 9.9 ↙ 9.8 ← 10.5 \* 10.1 ↘ 10.2 \*  
 10.3 \* 9.8 ← 10.2 \* 9.9 ↖ 10.6 \*  
 beste Teiler 78.4 (40.) 107.0 (33.) 157.0 (36.)  
 Trefferlage 0.79 mm links, 0.43 mm hoch  
 Streuwert 1.44, horizontal: 1.67, vertikal: 1.17

Unterschrift des Schützen

Ergebnis: **391.5** (375)  
 Serien: 98.8 95.0 99.5 98.2  
 Zähler: 17 21 2 0 0 0 0 0 0 0  
 Innenzehner: 11  
 weiteste: 579 (31), 523 (30), 486 (17)  
 beste Teiler 34.5 (9.) 56.5 (35.) 87.6 (39.)  
 Trefferlage 0.22 mm links, 0.04 mm tief  
 Streuwert 2.28, horizontal: 2.75, vertikal: 1.67

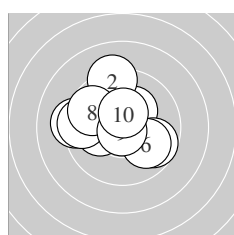
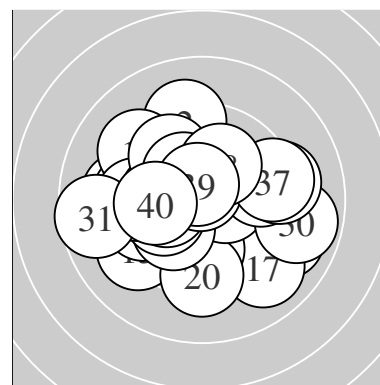

Serie 1:  
 10.3 \*                      9.2 ↑                      9.2 ←                      9.7 ↘                      10.1 ←  
 9.9 ↘                      9.5 ←                      9.7 ↖                      10.8 \*                      10.4 \*  
 beste Teiler 34.5 (9.) 128.1 (10.) 172.0 (1.)  
 Trefferlage 0.78 mm links, 0.56 mm hoch  
 Streuwert 2.06, horizontal: 2.37, vertikal: 1.69

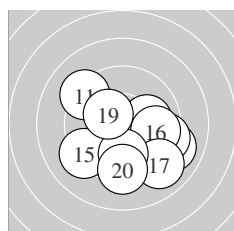

Serie 2:  
 9.2 ↖                      10.1 →                      9.0 ↘                      9.3 →                      9.2 ↙  
 9.7 →                      9.0 ↘                      9.9 ↓                      10.3 \*                      9.3 ↓  
 beste Teiler 158.1 (19.) 222.6 (12.) 267.0 (18.)  
 Trefferlage 0.85 mm rechts, 1.28 mm tief  
 Streuwert 2.55, horizontal: 2.92, vertikal: 2.13

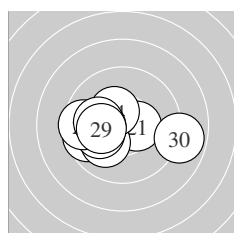

Serie 3:  
 10.4 \*                      9.6 ←                      10.1 ↙                      10.4 \*                      10.1 ←  
 9.5 ←                      10.2 \*                      10.1 ←                      10.2 \*                      8.9 →  
 beste Teiler 127.3 (21.) 143.5 (24.) 194.4 (29.)  
 Trefferlage 1.07 mm links, 0.35 mm tief  
 Streuwert 1.89, horizontal: 2.54, vertikal: 0.81

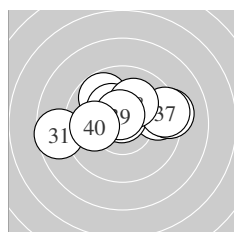

Serie 4:  
 8.6 ←                      9.8 ↖                      10.3 \*                      9.6 →                      10.7 \*  
 9.2 →                      9.4 →                      10.1 ↑                      10.6 \*                      9.9 ←  
 beste Teiler 56.5 (35.) 87.6 (39.) 172.8 (33.)  
 Trefferlage 0.08 mm rechts, 0.88 mm hoch  
 Streuwert 2.29, horizontal: 3.10, vertikal: 0.94

Unterschrift des Schützen

Meyton Elektronik

Ergebnis: **407.0** (386)  
 Serien: 103.7 103.0 99.7 100.6  
 Zähler: 28 10 2 0 0 0 0 0 0 0  
 Innenzehner: 25  
 weiteste: 739 (40), 508 (21), 388 (6)  
 beste Teiler 34.1 (12.) 38.3 (2.) 39.0 (32.)  
 Trefferlage 0.22 mm rechts, 0.41 mm hoch  
 Streuwert 1.68, horizontal: 1.87, vertikal: 1.47

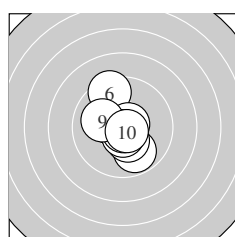
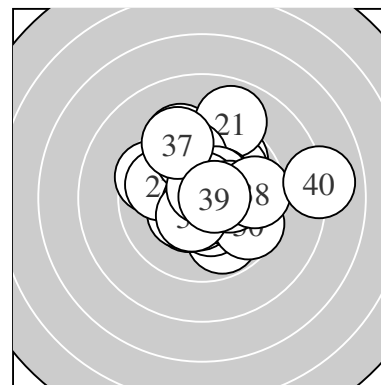

Serie 1:  
 10.4 \*                      10.8 \*                      9.8 ↘                      10.4 \*                      10.6 \*  
 9.4 ↗                      10.7 \*                      10.8 \*                      10.1 ↖                      10.7 \*  
 beste Teiler 38.3 (2.) 42.7 (8.) 59.4 (10.)  
 Trefferlage 0.16 mm links, 0.01 mm tief  
 Streuwert 1.36, horizontal: 1.05, vertikal: 1.62

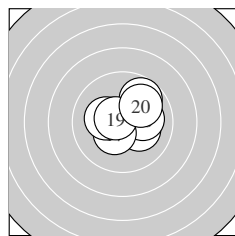

Serie 2:  
 10.2 \*                      10.8 \*                      10.6 \*                      9.7 ↗                      10.5 \*  
 10.1 →                      10.4 \*                      10.2 \*                      10.6 \*                      9.9 ↗  
 beste Teiler 34.1 (12.) 82.3 (19.) 98.0 (13.)  
 Trefferlage 0.18 mm rechts, 0.36 mm hoch  
 Streuwert 1.30, horizontal: 1.52, vertikal: 1.04

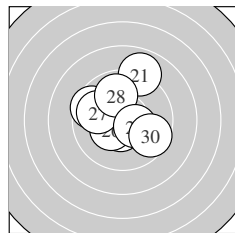

Serie 3:  
 8.9 ↗                      9.6 ↖                      10.5 \*                      10.5 \*                      10.1 ↘  
 10.3 \*                      9.9 ↖                      9.9 ↗                      10.4 \*                      9.6 ↘  
 beste Teiler 105.9 (24.) 122.0 (23.) 144.4 (29.)  
 Trefferlage 0.40 mm links, 0.70 mm hoch  
 Streuwert 1.94, horizontal: 1.91, vertikal: 1.97

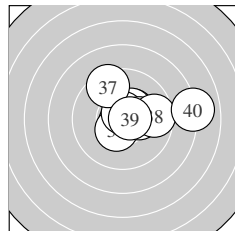

Serie 4:  
 10.4 \*                      10.8 \*                      10.4 \*                      10.4 \*                      10.7 \*  
 10.3 \*                      9.4 ↘                      9.6 →                      10.6 \*                      8.0 →  
 beste Teiler 39.0 (32.) 63.0 (35.) 77.3 (39.)  
 Trefferlage 1.26 mm rechts, 0.60 mm hoch  
 Streuwert 1.97, horizontal: 2.51, vertikal: 1.19

Unterschrift des Schützen

Meyton Elektronik

Ergebnis:	<b>411.8</b>	(395)
Serien:	104.3	102.6 101.7 103.2
Zähler:	35	5 0 0 0 0 0 0 0 0
Innenzehner:	28	
weiteste:	379	(14), 360 (26), 323 (34)
beste Teiler	31.9	(40.) 44.7 (8.) 63.1 (9.)
Trefferlage	0.28	mm rechts, 0.22 mm tief
Streuwert	1.32,	horizontal: 1.50, vertikal: 1.11

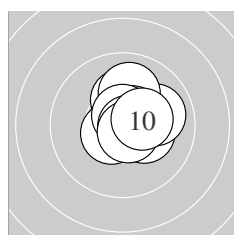
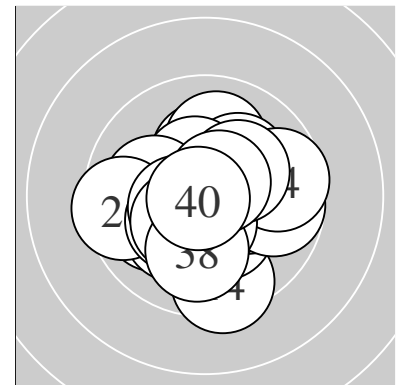

Serie 1:	10.3 *	10.2 *	10.6 *	10.0 →	10.0 ↑
	10.6 *	10.7 *	10.8 *	10.7 *	10.4 *
beste Teiler	44.7	(8.) 63.1 (9.)	71.0 (7.)		
Trefferlage	0.64	mm rechts, 0.49 mm hoch			
Streuwert	0.94,	horizontal: 0.91, vertikal: 0.98			

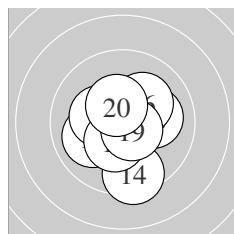

Serie 2:	10.7 *	10.1 →	10.0 ←	9.4 ↓	10.5 *
	10.2 *	10.3 *	10.4 *	10.6 *	10.4 *
beste Teiler	75.3	(11.) 85.9 (19.)	111.4 (15.)		
Trefferlage	0.05	mm links, 0.50 mm tief			
Streuwert	1.40,	horizontal: 1.32, vertikal: 1.48			

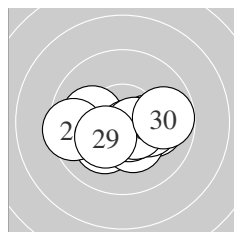

Serie 3:	10.2 *	10.1 →	10.1 ←	10.3 *	10.6 *
	9.5 ←	10.2 *	10.6 *	10.3 *	9.8 →
beste Teiler	76.6	(25.) 97.9 (28.)	160.1 (24.)		
Trefferlage	0.08	mm rechts, 0.54 mm tief			
Streuwert	1.54,	horizontal: 2.09, vertikal: 0.64			

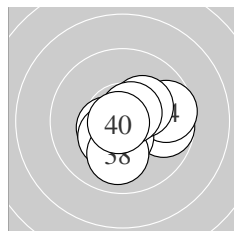

Serie 4:	10.7 *	9.8 →	10.5 *	9.7 →	10.5 *
	10.4 *	10.2 *	10.0 ↓	10.6 *	10.8 *
beste Teiler	31.9	(40.) 75.4 (31.)	85.5 (39.)		
Trefferlage	0.48	mm rechts, 0.36 mm tief			
Streuwert	1.31,	horizontal: 1.56, vertikal: 1.01			

Unterschrift des Schützen

Ergebnis: **380.7** (366)  
 Serien: 96.5 93.2 93.5 97.5  
 Zähler: 15 17 7 1 0 0 0 0 0 0  
 Innenzehner: 8  
 weiteste: 850 (17), 730 (16), 702 (21)  
 beste Teiler 53.3 (39.) 105.6 (15.) 105.7 (11.)  
 Trefferlage 0.92 mm links, 1.99 mm hoch  
 Streuwert 2.40, horizontal: 2.86, vertikal: 1.83

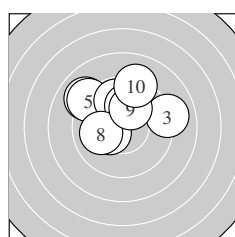
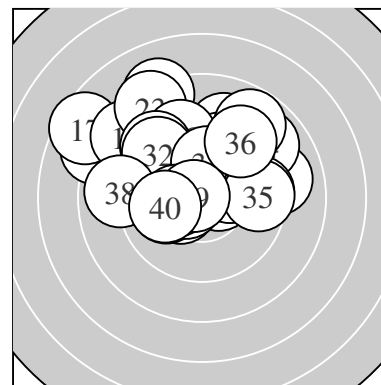

Serie 1:  
 10.0 ↘                      10.4 \*                      9.0 →                      9.0 ↘                      9.1 ↘  
 9.8 ↑                      10.0 ↑                      10.0 ←                      10.1 ↑                      9.1 ↑  
 beste Teiler 147.6 (2.) 213.7 (9.) 228.0 (7.)  
 Trefferlage 0.64 mm links, 1.82 mm hoch  
 Streuwert 2.12, horizontal: 2.56, vertikal: 1.57

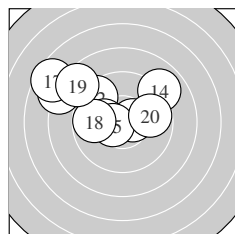

Serie 2:  
 10.5 \*                      9.4 ↘                      10.2 \*                      8.9 ↗                      10.5 \*  
 8.0 ↘                      7.6 ↘                      9.8 ←                      8.5 ↘                      9.8 →  
 beste Teiler 105.6 (15.) 105.7 (11.) 192.7 (13.)  
 Trefferlage 1.95 mm links, 1.80 mm hoch  
 Streuwert 2.94, horizontal: 3.74, vertikal: 1.80

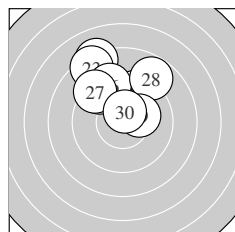

Serie 3:  
 8.1 ↘                      9.4 ↘                      8.3 ↘                      10.1 ↑                      9.6 ↗  
 9.3 ↘                      9.2 ↘                      8.8 ↗                      10.2 \*                      10.5 \*  
 beste Teiler 112.3 (30.) 185.8 (29.) 221.2 (24.)  
 Trefferlage 0.59 mm links, 3.39 mm hoch  
 Streuwert 2.03, horizontal: 2.20, vertikal: 1.84

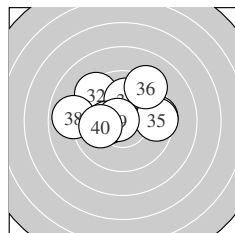

Serie 4:  
 9.9 ←                      9.4 ↘                      10.1 ↑                      9.5 →                      9.5 →  
 9.2 ↗                      10.3 \*                      8.9 ←                      10.7 \*                      10.0 ←  
 beste Teiler 53.3 (39.) 159.9 (37.) 225.1 (33.)  
 Trefferlage 0.50 mm links, 0.94 mm hoch  
 Streuwert 2.28, horizontal: 2.91, vertikal: 1.39

Unterschrift des Schützen

Meyton Elektronik

Ergebnis:	<b>399.6</b>	(382)
Serien:	100.5	100.6 99.5 99.0
Zähler:	23	16 1 0 0 0 0 0 0 0
Innenzehner:	18	
weiteste:	517 (28),	467 (19), 454 (38)
beste Teiler	43.9 (10.)	58.0 (18.) 72.9 (32.)
Trefferlage	0.49 mm links, 0.29 mm hoch	
Streuwert	1.91, horizontal: 2.30, vertikal: 1.42	

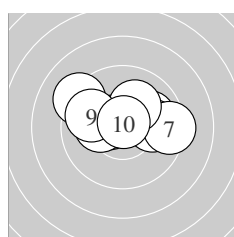
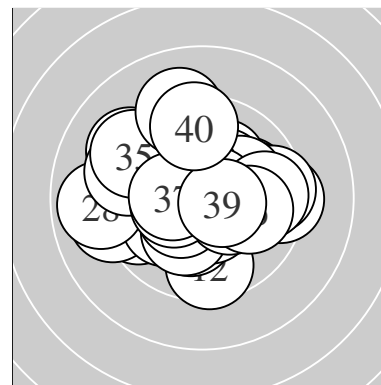

Serie 1:	10.5 *	10.0 →	10.6 *	9.2 ↖	10.2 *
	9.9 →	9.4 →	10.1 ↗	9.8 ↖	10.8 *
beste Teiler	43.9 (10.)	97.6 (3.)	113.8 (1.)		
Trefferlage	0.02 mm links, 0.74 mm hoch				
Streuwert	1.83, horizontal: 2.46, vertikal: 0.79				

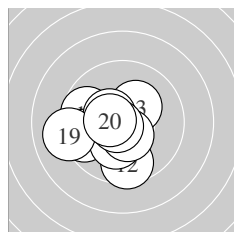

Serie 2:	9.7 ↖	9.6 ↓	10.3 *	9.6 ↖	10.2 *
	10.5 *	10.4 *	10.7 *	9.1 ↖	10.5 *
beste Teiler	58.0 (18.)	109.1 (20.)	118.6 (16.)		
Trefferlage	1.21 mm links, 0.59 mm tief				
Streuwert	1.63, horizontal: 1.83, vertikal: 1.40				

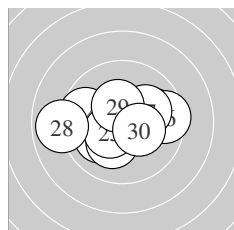

Serie 3:	10.1 ↖	9.9 →	10.2 *	9.7 ↖	10.4 *
	9.5 →	10.1 →	8.9 ←	10.4 *	10.3 *
beste Teiler	134.8 (25.)	143.9 (29.)	154.3 (30.)		
Trefferlage	0.30 mm links, 0.07 mm tief				
Streuwert	2.06, horizontal: 2.72, vertikal: 1.03				

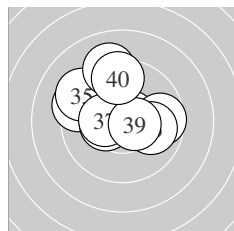

Serie 4:	9.4 ↖	10.7 *	10.4 *	9.7 →	9.3 ↖
	10.0 →	10.4 *	9.1 ↗	10.5 *	9.5 ↑
beste Teiler	72.9 (32.)	106.2 (39.)	145.9 (33.)		
Trefferlage	0.44 mm links, 1.10 mm hoch				
Streuwert	2.05, horizontal: 2.30, vertikal: 1.77				

Unterschrift des Schützen

Ergebnis: **405.3** (388)  
 Serien: 98.8 101.1 103.3 102.1  
 Zähler: 29 10 1 0 0 0 0 0 0 0  
 Innenzehner: 19  
 weiteste: 531 (1), 426 (10), 316 (27)  
 beste Teiler 37.0 (14.) 41.0 (17.) 65.0 (23.)  
 Trefferlage 0.48 mm rechts, 0.96 mm hoch  
 Streuwert 1.41, horizontal: 1.59, vertikal: 1.22

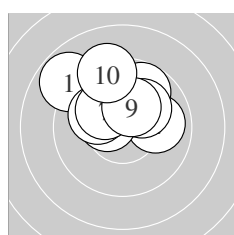
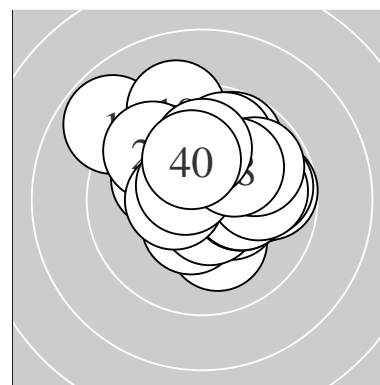

Serie 1:  
 8.8 ↘                      9.9 →                      9.7 ↗                      10.5 \*                      10.1 ↖  
 10.0 ↑                      10.2 \*                      10.1 ↗                      10.3 \*                      9.2 ↑  
 beste Teiler 121.7 (4.) 167.0 (9.) 187.3 (7.)  
 Trefferlage 0.42 mm links, 1.82 mm hoch  
 Streuwert 1.64, horizontal: 1.95, vertikal: 1.26

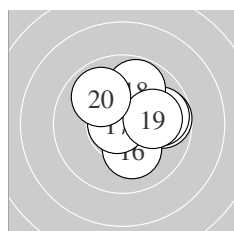

Serie 2:  
 9.7 →                      10.1 ↗                      9.8 →                      10.8 \*                      10.1 →  
 10.1 ↓                      10.8 \*                      9.8 ↑                      10.0 →                      9.9 ↖  
 beste Teiler 37.0 (14.) 41.0 (17.) 201.8 (16.)  
 Trefferlage 1.13 mm rechts, 0.62 mm hoch  
 Streuwert 1.37, horizontal: 1.47, vertikal: 1.28

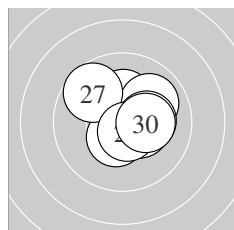

Serie 3:  
 10.5 \*                      10.6 \*                      10.7 \*                      10.3 \*                      10.0 ↗  
 10.4 \*                      9.7 ↘                      10.2 \*                      10.6 \*                      10.3 \*  
 beste Teiler 65.0 (23.) 79.6 (29.) 90.5 (22.)  
 Trefferlage 0.58 mm rechts, 0.37 mm hoch  
 Streuwert 1.20, horizontal: 1.29, vertikal: 1.11

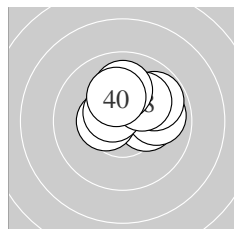

Serie 4:  
 10.4 \*                      10.2 \*                      10.4 \*                      9.9 →                      10.5 \*  
 10.6 \*                      9.8 ↗                      10.1 ↗                      10.0 ↑                      10.2 \*  
 beste Teiler 100.6 (36.) 120.0 (35.) 126.0 (33.)  
 Trefferlage 0.62 mm rechts, 1.04 mm hoch  
 Streuwert 1.12, horizontal: 1.37, vertikal: 0.79

Unterschrift des Schützen

Meyton Elektronik



Ergebnis: **393.9** (377)  
 Serien: 98.2 96.8 97.4 101.5  
 Zähler: 19 19 2 0 0 0 0 0 0 0  
 Innenzehner: 13  
 weiteste: 570 (4), 524 (17), 475 (15)  
 beste Teiler 91.7 (31.) 94.6 (39.) 94.8 (14.)  
 Trefferlage 0.26 mm links, 0.20 mm hoch  
 Streuwert 2.16, horizontal: 2.55, vertikal: 1.68

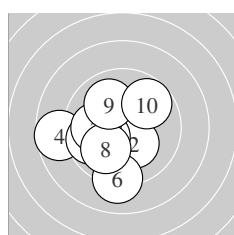
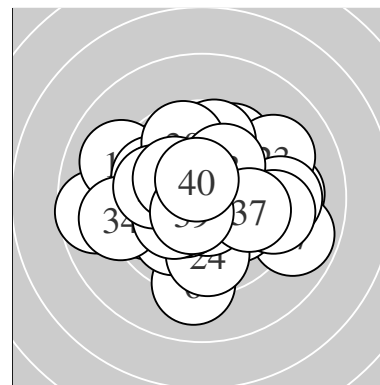

Serie 1:  
 10.6 \*                      10.2 \*                      10.2 \*                      8.7 ←                      9.7 ←  
 9.1 ↓                      10.0 ←                      10.0 ↗                      10.0 ↖                      9.7 ↗  
 beste Teiler 97.1 (1.) 176.4 (2.) 178.5 (3.)  
 Trefferlage 1.23 mm links, 0.55 mm tief  
 Streuwert 2.09, horizontal: 2.18, vertikal: 1.99

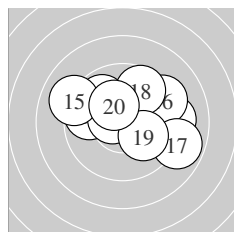

Serie 2:  
 9.7 ←                      9.9 ↖                      9.2 →                      10.6 \*                      9.1 ↖  
 9.3 ↗                      8.9 ↘                      9.7 ↑                      10.1 ↘                      10.3 \*  
 beste Teiler 94.8 (14.) 169.4 (20.) 221.0 (19.)  
 Trefferlage 0.54 mm rechts, 0.83 mm hoch  
 Streuwert 2.49, horizontal: 3.18, vertikal: 1.53

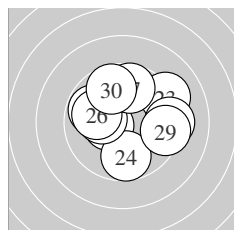

Serie 3:  
 10.4 \*                      9.8 ↖                      9.2 ↗                      9.7 ↓                      10.2 \*  
 10.0 ←                      9.7 ↑                      9.3 →                      9.4 →                      9.7 ↖  
 beste Teiler 127.5 (21.) 186.2 (25.) 241.0 (26.)  
 Trefferlage 0.38 mm rechts, 0.62 mm hoch  
 Streuwert 2.30, horizontal: 2.68, vertikal: 1.85

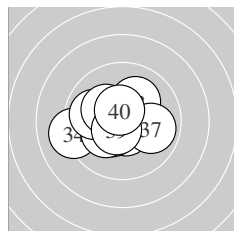

Serie 4:  
 10.6 \*                      10.4 \*                      10.1 ↗                      9.1 ←                      10.2 \*  
 9.9 ←                      9.9 →                      10.2 \*                      10.6 \*                      10.5 \*  
 beste Teiler 91.7 (31.) 94.6 (39.) 101.9 (40.)  
 Trefferlage 0.76 mm links, 0.10 mm tief  
 Streuwert 1.55, horizontal: 1.92, vertikal: 1.07

Unterschrift des Schützen

Meyton Elektronik

Ergebnis: **393.8** (374)  
 Serien: 98.5 99.0 97.7 98.6  
 Zähler: 18 18 4 0 0 0 0 0 0 0  
 Innenzehner: 15  
 weiteste: 634 (12), 533 (15), 521 (6)  
 beste Teiler 27.6 (40.) 68.1 (20.) 93.7 (32.)  
 Trefferlage 0.88 mm rechts, 0.39 mm hoch  
 Streuwert 2.16, horizontal: 2.36, vertikal: 1.95

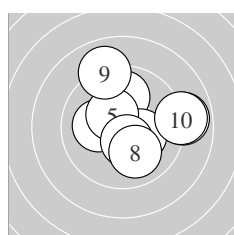
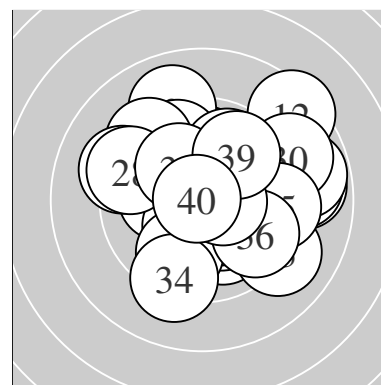

Serie 1:  
 10.5 \*                      9.9 ↑                      10.3 \*                      10.1 ←                      10.4 \*  
 8.9 →                      10.5 \*                      10.0 ↘                      9.0 ↗                      8.9 →  
 beste Teiler 103.0 (1.) 124.3 (7.) 139.9 (5.)  
 Trefferlage 0.93 mm rechts, 0.51 mm hoch  
 Streuwert 2.22, horizontal: 2.45, vertikal: 1.97

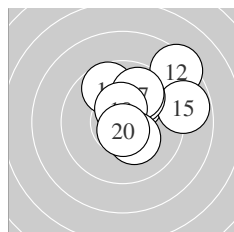

Serie 2:  
 10.6 \*                      8.4 ↗                      10.2 \*                      9.7 ↘                      8.8 →  
 9.9 ↗                      9.9 ↗                      10.5 \*                      10.3 \*                      10.7 \*  
 beste Teiler 68.1 (20.) 94.8 (11.) 115.8 (18.)  
 Trefferlage 1.37 mm rechts, 1.46 mm hoch  
 Streuwert 1.85, horizontal: 2.02, vertikal: 1.67

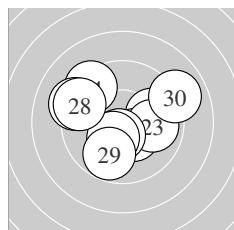

Serie 3:  
 9.9 →                      10.4 \*                      9.9 →                      9.3 ↘                      10.5 \*  
 9.2 ←                      10.3 \*                      9.4 ←                      9.8 ↓                      9.0 →  
 beste Teiler 114.9 (25.) 144.8 (22.) 155.7 (27.)  
 Trefferlage 0.22 mm links, 0.23 mm hoch  
 Streuwert 2.38, horizontal: 2.84, vertikal: 1.82

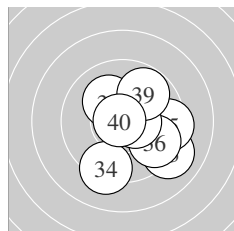

Serie 4:  
 9.3 ↘                      10.6 \*                      9.1 ↘                      9.3 ↓                      9.4 →  
 9.7 ↘                      10.5 \*                      10.1 ↘                      9.8 ↗                      10.8 \*  
 beste Teiler 27.6 (40.) 93.7 (32.) 108.2 (37.)  
 Trefferlage 1.44 mm rechts, 0.61 mm tief  
 Streuwert 2.01, horizontal: 2.02, vertikal: 2.00

Unterschrift des Schützen

Meyton Elektronik

Ergebnis: **406.0** (388)  
 Serien: 99.8 101.9 103.2 101.1  
 Zähler: 28 12 0 0 0 0 0 0 0 0  
 Innenzehner: 20  
 weiteste: 411 (5), 366 (40), 341 (10)  
 beste Teiler 19.0 (23.) 50.6 (18.) 71.2 (31.)  
 Trefferlage 0.14 mm links, 0.24 mm hoch  
 Streuwert 1.56, horizontal: 1.83, vertikal: 1.23

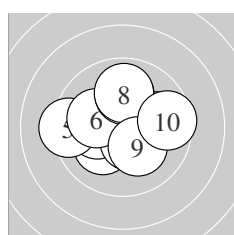
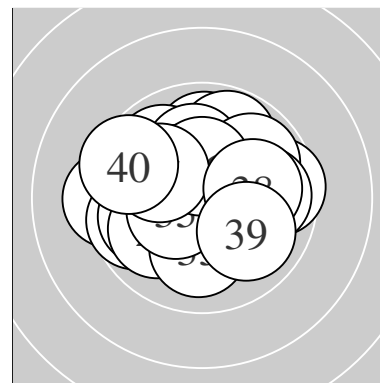

Serie 1:  
 10.1 ↙ 10.2 \* 9.9 → 10.5 \* 9.3 ←  
 10.1 ↖ 10.0 ↑ 9.9 ↑ 10.2 \* 9.6 →  
 beste Teiler 119.4 (4.) 185.8 (9.) 190.7 (2.)  
 Trefferlage 0.16 mm links, 0.25 mm hoch  
 Streuwert 1.88, horizontal: 2.25, vertikal: 1.42

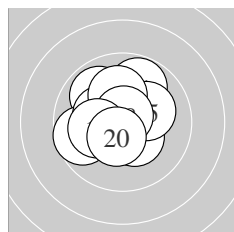

Serie 2:  
 10.4 \* 9.9 ↘ 9.7 ← 9.8 ↗ 10.2 \*  
 10.3 \* 10.1 ↑ 10.8 \* 10.2 \* 10.5 \*  
 beste Teiler 50.6 (18.) 119.2 (20.) 144.1 (11.)  
 Trefferlage 0.51 mm links, 0.48 mm hoch  
 Streuwert 1.47, horizontal: 1.54, vertikal: 1.40

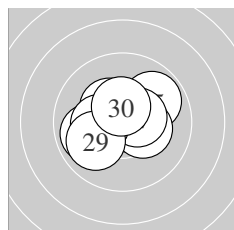

Serie 3:  
 10.4 \* 10.5 \* 10.9 \* 9.9 ← 9.9 ↗  
 10.3 \* 10.5 \* 10.3 \* 10.0 ← 10.5 \*  
 beste Teiler 19.0 (23.) 107.7 (22.) 117.6 (27.)  
 Trefferlage 0.12 mm links, 0.14 mm hoch  
 Streuwert 1.33, horizontal: 1.63, vertikal: 0.95

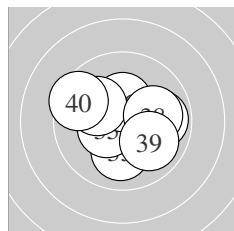

Serie 4:  
 10.7 \* 10.2 \* 10.0 ↓ 9.9 → 10.4 \*  
 10.4 \* 10.1 ↖ 10.0 → 9.9 ↘ 9.5 ↖  
 beste Teiler 71.2 (31.) 131.1 (35.) 144.0 (36.)  
 Trefferlage 0.22 mm rechts, 0.09 mm hoch  
 Streuwert 1.67, horizontal: 2.00, vertikal: 1.25

Unterschrift des Schützen

Ergebnis: **387.1** (370)  
 Serien: 90.9 98.4 101.4 96.4  
 Zähler: 19 14 6 0 1 0 0 0 0 0  
 Innenzehner: 14  
 weiteste: 1121 (34), 682 (3), 657 (5)  
 beste Teiler 75.5 (37.) 93.2 (33.) 97.1 (22.)  
 Trefferlage 0.03 mm rechts, 1.12 mm tief  
 Streuwert 2.58, horizontal: 2.26, vertikal: 2.88

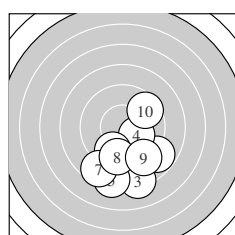
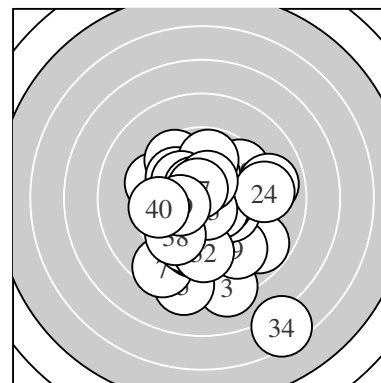

Serie 1:  
 8.9 ↓                      8.8 ↘                      8.2 ↓                      10.2 \*                      8.3 ↓  
 9.7 ↓                      8.6 ↙                      9.5 ↓                      9.1 ↘                      9.6 ↗  
 beste Teiler 197.8 (4.) 309.4 (6.) 348.6 (10.)  
 Trefferlage 0.61 mm rechts, 3.55 mm tief  
 Streuwert 2.46, horizontal: 2.31, vertikal: 2.60

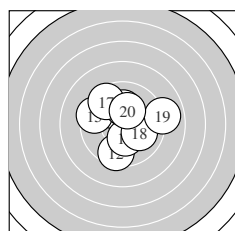

Serie 2:  
 10.1 ↖                      9.5 ↓                      10.1 ↖                      10.3 \*                      9.5 ↖  
 10.2 \*                      9.6 ↖                      10.0 ↘                      8.9 →                      10.2 \*  
 beste Teiler 173.3 (14.) 176.1 (20.) 199.2 (16.)  
 Trefferlage 0.03 mm links, 0.60 mm hoch  
 Streuwert 2.17, horizontal: 2.32, vertikal: 2.01

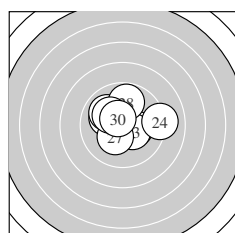

Serie 3:  
 10.3 \*                      10.6 \*                      10.4 \*                      9.1 →                      10.1 ↖  
 10.0 ↖                      10.3 \*                      9.8 ↑                      10.2 \*                      10.6 \*  
 beste Teiler 97.1 (22.) 100.2 (30.) 145.3 (23.)  
 Trefferlage 0.00 mm , 0.51 mm hoch  
 Streuwert 1.68, horizontal: 2.03, vertikal: 1.23

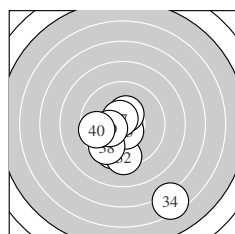

Serie 4:  
 9.6 ↓                      9.3 ↓                      10.6 \*                      6.5 ↘                      9.8 ←  
 10.4 \*                      10.7 \*                      9.6 ↙                      10.3 \*                      9.6 ←  
 beste Teiler 75.5 (37.) 93.2 (33.) 131.2 (36.)  
 Trefferlage 0.42 mm links, 2.06 mm tief  
 Streuwert 2.85, horizontal: 2.56, vertikal: 3.11

Unterschrift des Schützen

Meyton Elektronik

Ergebnis: **406.7** (390)  
 Serien: 101.3 101.7 102.1 101.6  
 Zähler: 31 8 1 0 0 0 0 0 0 0  
 Innenzehner: 23  
 weiteste: 513 (33), 493 (2), 378 (18)  
 beste Teiler 41.4 (15.) 48.0 (28.) 81.1 (5.)  
 Trefferlage 0.40 mm rechts, 0.78 mm hoch  
 Streuwert 1.46, horizontal: 1.47, vertikal: 1.45

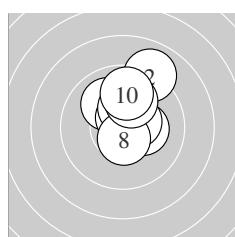
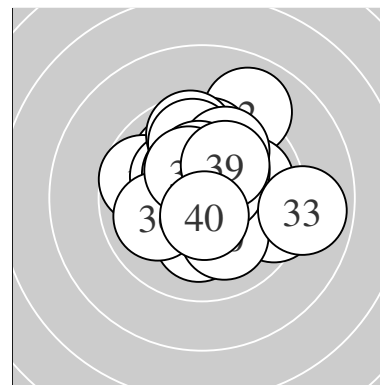

Serie 1:  
 10.2 \*                    9.0 ↗                    10.3 \*                    10.0 ↘                    10.6 \*  
 10.3 \*                    10.5 \*                    10.6 \*                    10.0 ↑                    9.8 ↑  
 beste Teiler 81.1 (5.) 97.6 (8.) 118.1 (7.)  
 Trefferlage 0.57 mm rechts, 1.48 mm hoch  
 Streuwert 1.29, horizontal: 0.99, vertikal: 1.53

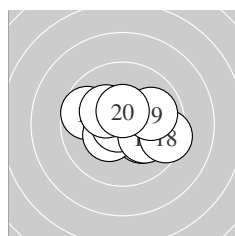

Serie 2:  
 10.5 \*                    10.2 \*                    9.7 ↖                    10.4 \*                    10.8 \*  
 10.2 \*                    10.1 ↘                    9.4 →                    9.9 →                    10.5 \*  
 beste Teiler 41.4 (15.) 101.2 (11.) 111.0 (20.)  
 Trefferlage 0.37 mm rechts, 0.08 mm hoch  
 Streuwert 1.58, horizontal: 2.00, vertikal: 1.00

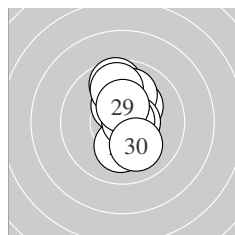

Serie 3:  
 10.2 \*                    9.7 ↑                    10.4 \*                    10.0 ↑                    10.6 \*  
 10.1 ↓                    9.8 ↑                    10.8 \*                    10.4 \*                    10.1 ↘  
 beste Teiler 48.0 (28.) 95.0 (25.) 136.0 (29.)  
 Trefferlage 0.27 mm rechts, 0.85 mm hoch  
 Streuwert 1.36, horizontal: 0.69, vertikal: 1.80

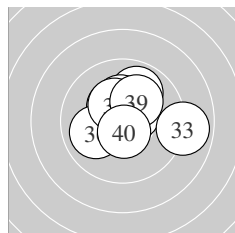

Serie 4:  
 10.4 \*                    10.5 \*                    8.9 →                    10.6 \*                    9.9 ↗  
 10.0 ←                    10.3 \*                    10.3 \*                    10.1 ↗                    10.6 \*  
 beste Teiler 90.7 (40.) 96.5 (34.) 110.6 (32.)  
 Trefferlage 0.40 mm rechts, 0.72 mm hoch  
 Streuwert 1.61, horizontal: 1.95, vertikal: 1.17

Unterschrift des Schützen

Meyton Elektronik

Ergebnis: **381.7** (364)  
 Serien: 95.1 97.4 93.9 95.3  
 Zähler: 13 19 7 1 0 0 0 0 0 0  
 Innenzehner: 10  
 weiteste: 816 (37), 733 (7), 594 (5)  
 beste Teiler 73.8 (8.) 89.2 (4.) 125.2 (12.)  
 Trefferlage 0.55 mm rechts, 0.40 mm hoch  
 Streuwert 2.76, horizontal: 3.10, vertikal: 2.37

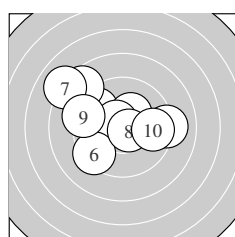
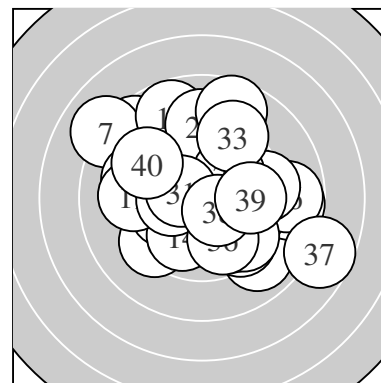

Serie 1:  
 9.1 → 9.6 ↘ 10.3 \* 10.6 \* 8.6 ↖  
 9.3 ↙ 8.0 ↘ 10.7 \* 9.2 ← 9.7 →  
 beste Teiler 73.8 (8.) 89.2 (4.) 162.0 (3.)  
 Trefferlage 1.14 mm links, 1.01 mm hoch  
 Streuwert 2.86, horizontal: 3.46, vertikal: 2.10

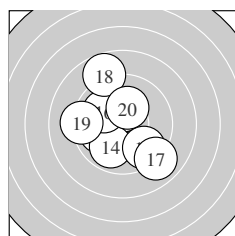

Serie 2:  
 10.0 ← 10.5 \* 10.4 \* 9.9 ↙ 9.6 ↘  
 10.0 ↘ 8.9 ↘ 8.7 ↘ 9.2 ← 10.2 \*  
 beste Teiler 125.2 (12.) 143.0 (13.) 179.4 (20.)  
 Trefferlage 0.60 mm links, 0.16 mm hoch  
 Streuwert 2.44, horizontal: 2.29, vertikal: 2.58

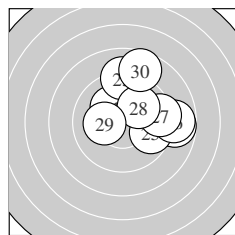

Serie 3:  
 10.2 \* 9.1 → 9.1 ↑ 8.8 → 9.7 →  
 8.8 → 9.4 → 10.0 ↗ 10.2 \* 8.6 ↑  
 beste Teiler 190.5 (29.) 194.2 (21.) 229.2 (28.)  
 Trefferlage 2.28 mm rechts, 1.21 mm hoch  
 Streuwert 2.44, horizontal: 2.67, vertikal: 2.19

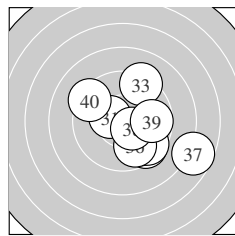

Serie 4:  
 10.4 \* 9.5 ↘ 9.2 ↗ 9.7 ↘ 9.5 ↘  
 9.8 ↘ 7.7 ↘ 10.5 \* 9.7 → 9.3 ↖  
 beste Teiler 125.8 (38.) 138.8 (31.) 289.3 (36.)  
 Trefferlage 1.68 mm rechts, 0.78 mm tief  
 Streuwert 2.63, horizontal: 2.83, vertikal: 2.40

Unterschrift des Schützen

Meyton Elektronik

Ergebnis: **411.8** (395)  
 Serien: 102.0 102.9 103.1 103.8  
 Zähler: 35 5 0 0 0 0 0 0 0 0  
 Innenzehner: 31  
 weiteste: 433 (17), 377 (9), 291 (6)  
 beste Teiler 46.8 (1.) 59.4 (40.) 65.0 (28.)  
 Trefferlage 0.49 mm links, 0.19 mm hoch  
 Streuwert 1.26, horizontal: 1.50, vertikal: 0.95

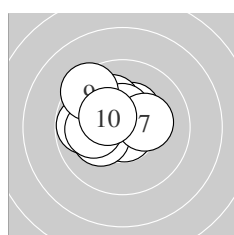
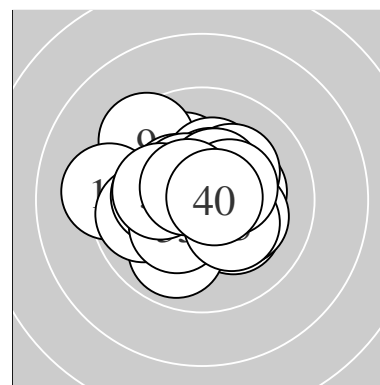

Serie 1:  
 10.8 \*                      10.4 \*                      10.1 ↗                      10.5 \*                      10.2 \*  
 9.8 ←                      10.3 \*                      10.1 ←                      9.4 ↘                      10.4 \*  
 beste Teiler 46.8 (1.) 115.0 (4.) 141.5 (2.)  
 Trefferlage 0.89 mm links, 0.69 mm hoch  
 Streuwert 1.32, horizontal: 1.51, vertikal: 1.09

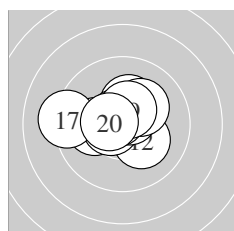

Serie 2:  
 10.1 ←                      10.2 \*                      10.3 \*                      10.6 \*                      10.6 \*  
 10.7 \*                      9.2 ←                      10.2 \*                      10.5 \*                      10.5 \*  
 beste Teiler 67.2 (16.) 81.0 (15.) 92.9 (14.)  
 Trefferlage 0.46 mm links, 0.41 mm hoch  
 Streuwert 1.38, horizontal: 1.76, vertikal: 0.83

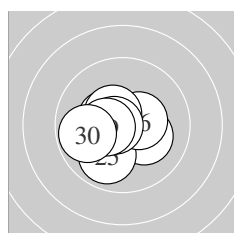

Serie 3:  
 10.2 \*                      10.3 \*                      10.5 \*                      10.4 \*                      9.9 ↘  
 10.4 \*                      10.5 \*                      10.7 \*                      10.4 \*                      9.8 ←  
 beste Teiler 65.0 (28.) 114.7 (27.) 118.3 (23.)  
 Trefferlage 0.74 mm links, 0.30 mm tief  
 Streuwert 1.12, horizontal: 1.29, vertikal: 0.91

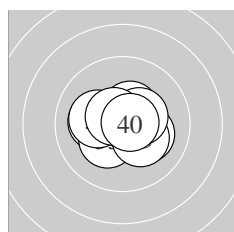

Serie 4:  
 10.1 ←                      10.5 \*                      10.3 \*                      10.2 \*                      10.3 \*  
 10.5 \*                      10.4 \*                      10.2 \*                      10.6 \*                      10.7 \*  
 beste Teiler 59.4 (40.) 88.5 (39.) 123.0 (32.)  
 Trefferlage 0.10 mm rechts, 0.00 mm  
 Streuwert 1.15, horizontal: 1.43, vertikal: 0.76

Unterschrift des Schützen

Meyton Elektronik

Ergebnis: **400.2** (379)  
 Serien: 99.1 101.0 99.3 100.8  
 Zähler: 20 19 1 0 0 0 0 0 0 0  
 Innenzehner: 12  
 weiteste: 517 (1), 414 (26), 403 (29)  
 beste Teiler 16.6 (5.) 44.2 (11.) 53.0 (32.)  
 Trefferlage 0.70 mm rechts, 0.00 mm  
 Streuwert 1.81, horizontal: 1.81, vertikal: 1.82

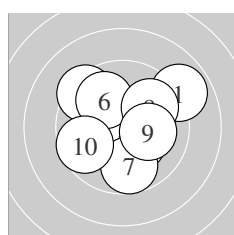
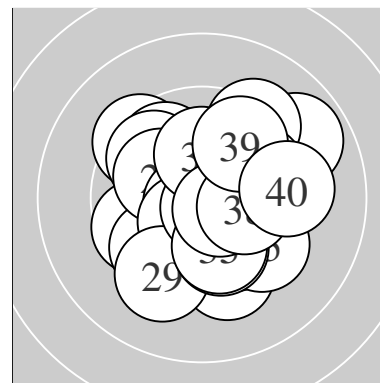

Serie 1:  
 8.9 ↗ 10.4 \* 10.3 \* 9.4 ↘ 10.9 \*  
 9.9 ↘ 9.7 ↓ 9.9 ↗ 10.1 → 9.6 ←  
 beste Teiler 16.6 (5.) 134.0 (2.) 166.8 (3.)  
 Trefferlage 0.43 mm rechts, 0.25 mm hoch  
 Streuwert 2.13, horizontal: 2.33, vertikal: 1.92

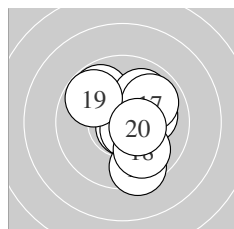

Serie 2:  
 10.8 \* 10.1 → 10.7 \* 9.8 ↘ 9.5 ↓  
 10.0 ↗ 9.9 ↗ 9.9 ↘ 9.8 ↘ 10.5 \*  
 beste Teiler 44.2 (11.) 74.6 (13.) 124.2 (20.)  
 Trefferlage 0.61 mm rechts, 0.11 mm hoch  
 Streuwert 1.72, horizontal: 1.52, vertikal: 1.90

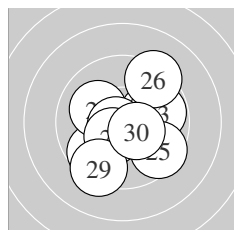

Serie 3:  
 10.1 → 9.7 ↙ 9.8 → 10.1 ↘ 9.5 ↘  
 9.3 ↗ 10.7 \* 10.4 \* 9.3 ↙ 10.4 \*  
 beste Teiler 59.0 (27.) 129.5 (30.) 137.0 (28.)  
 Trefferlage 0.38 mm rechts, 0.43 mm tief  
 Streuwert 2.03, horizontal: 2.05, vertikal: 2.01

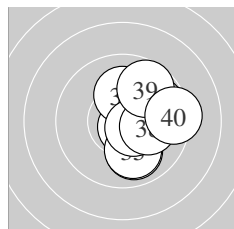

Serie 4:  
 10.6 \* 10.7 \* 9.8 ↗ 9.9 ↓ 10.0 ↓  
 10.1 ↑ 10.6 \* 10.1 → 9.7 ↗ 9.3 →  
 beste Teiler 53.0 (32.) 84.3 (31.) 99.6 (37.)  
 Trefferlage 1.39 mm rechts, 0.06 mm hoch  
 Streuwert 1.44, horizontal: 1.22, vertikal: 1.63

Unterschrift des Schützen

Meyton Elektronik



Ergebnis: **403.8** (386)  
 Serien: 101.1 101.0 101.5 100.2  
 Zähler: 27 12 1 0 0 0 0 0 0 0  
 Innenzehner: 19  
 weiteste: 513 (35), 474 (17), 434 (36)  
 beste Teiler 47.1 (7.) 53.7 (18.) 64.3 (23.)  
 Trefferlage 0.19 mm links, 0.09 mm hoch  
 Streuwert 1.74, horizontal: 1.84, vertikal: 1.63

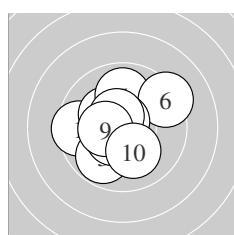
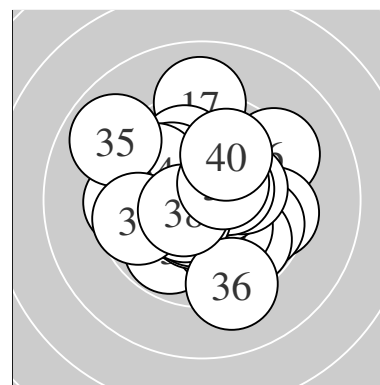

Serie 1:  
 9.5 ← 10.3 \* 9.8 ↗ 10.5 \* 9.9 ↑  
 9.3 ↘ 10.8 \* 10.5 \* 10.4 \* 10.1 ↓  
 beste Teiler 47.1 (7.) 101.5 (8.) 116.3 (4.)  
 Trefferlage 0.48 mm links, 0.18 mm hoch  
 Streuwert 1.73, horizontal: 1.84, vertikal: 1.62

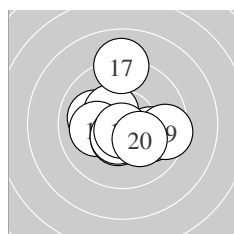

Serie 2:  
 10.0 → 10.0 ← 10.4 \* 10.1 ← 10.5 \*  
 10.5 \* 9.1 ↑ 10.7 \* 9.5 → 10.2 \*  
 beste Teiler 53.7 (18.) 108.6 (16.) 119.2 (15.)  
 Trefferlage 0.08 mm rechts, 0.05 mm hoch  
 Streuwert 1.80, horizontal: 1.81, vertikal: 1.79

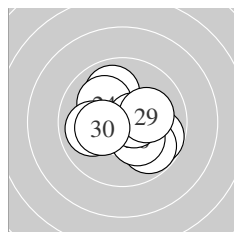

Serie 3:  
 9.9 ↗ 9.8 → 10.7 \* 10.1 ↘ 9.8 ↘  
 10.2 \* 10.6 \* 10.0 ← 10.1 → 10.3 \*  
 beste Teiler 64.3 (23.) 94.2 (27.) 172.2 (30.)  
 Trefferlage 0.20 mm rechts, 0.04 mm tief  
 Streuwert 1.59, horizontal: 1.82, vertikal: 1.33

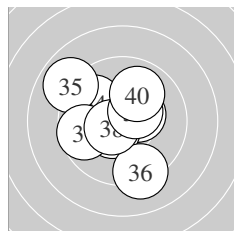

Serie 4:  
 10.7 \* 10.4 \* 10.5 \* 9.9 ↘ 8.9 ↘  
 9.2 ↓ 9.7 ← 10.5 \* 10.4 \* 10.0 ↗  
 beste Teiler 64.6 (31.) 102.5 (38.) 114.5 (33.)  
 Trefferlage 0.59 mm links, 0.20 mm hoch  
 Streuwert 2.00, horizontal: 2.04, vertikal: 1.97

Unterschrift des Schützen

Meyton Elektronik

Ergebnis: **410.3** (394)  
 Serien: 102.8 102.0 104.2 101.3  
 Zähler: 34 6 0 0 0 0 0 0 0 0  
 Innenzehner: 29  
 weiteste: 419 (33), 401 (16), 395 (36)  
 beste Teiler 41.0 (26.) 44.7 (8.) 56.7 (27.)  
 Trefferlage 0.42 mm rechts, 0.08 mm hoch  
 Streuwert 1.36, horizontal: 1.51, vertikal: 1.20

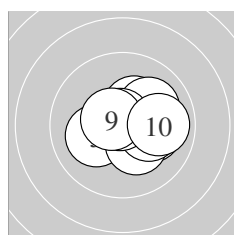
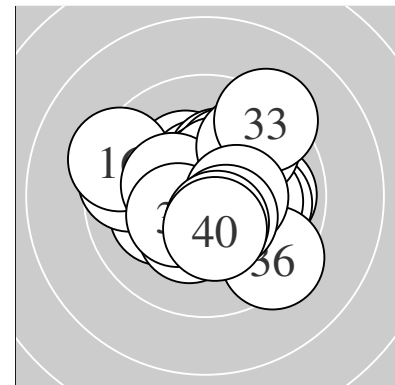

Serie 1:  
 10.1 → 10.4 \* 10.1 ← 10.3 \* 10.3 \*  
 10.2 \* 10.1 ↗ 10.8 \* 10.6 \* 9.9 →  
 beste Teiler 44.7 (8.) 89.9 (9.) 145.6 (2.)  
 Trefferlage 0.59 mm rechts, 0.00 mm  
 Streuwert 1.26, horizontal: 1.57, vertikal: 0.85

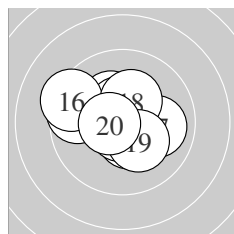

Serie 2:  
 10.5 \* 10.3 \* 10.5 \* 10.7 \* 9.6 ←  
 9.3 ↖ 10.0 → 10.3 \* 10.2 \* 10.6 \*  
 beste Teiler 62.0 (14.) 95.6 (20.) 107.9 (13.)  
 Trefferlage 0.45 mm links, 0.28 mm hoch  
 Streuwert 1.54, horizontal: 1.87, vertikal: 1.12

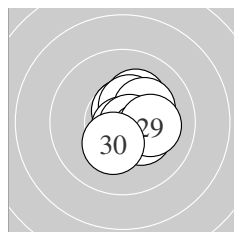

Serie 3:  
 10.2 \* 10.6 \* 10.6 \* 10.4 \* 10.2 \*  
 10.8 \* 10.7 \* 10.3 \* 10.1 → 10.3 \*  
 beste Teiler 41.0 (26.) 56.7 (27.) 82.0 (23.)  
 Trefferlage 0.62 mm rechts, 0.21 mm hoch  
 Streuwert 0.92, horizontal: 0.83, vertikal: 1.01

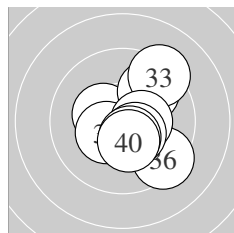

Serie 4:  
 10.4 \* 9.8 ↗ 9.3 ↗ 10.4 \* 10.4 \*  
 9.4 ↘ 10.4 \* 10.4 \* 10.4 \* 10.4 \*  
 beste Teiler 127.1 (39.) 127.2 (38.) 136.0 (37.)  
 Trefferlage 0.93 mm rechts, 0.16 mm tief  
 Streuwert 1.59, horizontal: 1.43, vertikal: 1.74

Unterschrift des Schützen

Ergebnis: **407.7** (390)  
 Serien: 100.7 102.8 103.2 101.0  
 Zähler: 30 10 0 0 0 0 0 0 0 0  
 Innenzehner: 24  
 weiteste: 461 (13), 382 (3), 376 (33)  
 beste Teiler 21.5 (15.) 54.0 (29.) 58.5 (16.)  
 Trefferlage 0.30 mm rechts, 0.24 mm hoch  
 Streuwert 1.51, horizontal: 1.51, vertikal: 1.51

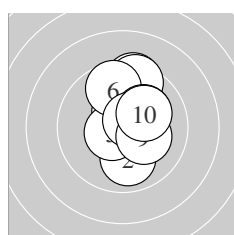
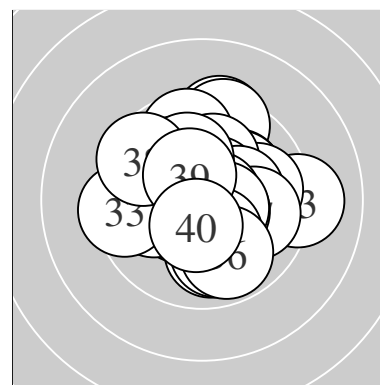

Serie 1:  
 10.5 \*                      10.0 ↓                      9.4 ↑                      9.5 ↑                      10.6 \*  
 9.7 ↑                      10.1 ↗                      10.6 \*                      10.2 \*                      10.1 ↗  
 beste Teiler 85.7 (8.) 94.3 (5.) 123.1 (1.)  
 Trefferlage 0.62 mm rechts, 1.08 mm hoch  
 Streuwert 1.57, horizontal: 0.97, vertikal: 1.99

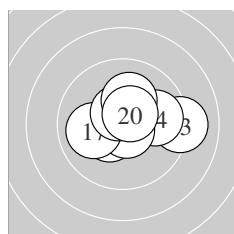

Serie 2:  
 10.4 \*                      10.5 \*                      9.1 →                      9.9 →                      10.9 \*  
 10.7 \*                      10.0 ←                      10.6 \*                      10.2 \*                      10.5 \*  
 beste Teiler 21.5 (15.) 58.5 (16.) 97.4 (18.)  
 Trefferlage 0.53 mm rechts, 0.33 mm hoch  
 Streuwert 1.48, horizontal: 1.91, vertikal: 0.85

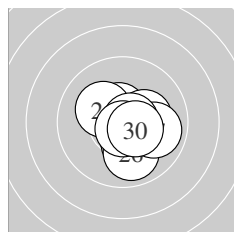

Serie 3:  
 10.6 \*                      10.2 \*                      10.2 \*                      10.2 \*                      10.3 \*  
 9.9 ↓                      9.9 →                      10.7 \*                      10.7 \*                      10.5 \*  
 beste Teiler 54.0 (29.) 63.6 (28.) 96.7 (21.)  
 Trefferlage 0.69 mm rechts, 0.40 mm tief  
 Streuwert 1.12, horizontal: 1.15, vertikal: 1.08

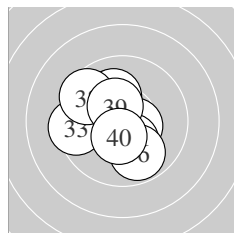

Serie 4:  
 10.1 ↘                      10.5 \*                      9.4 ←                      10.5 \*                      10.2 \*  
 9.8 ↓                      10.1 ↑                      9.6 ↘                      10.4 \*                      10.4 \*  
 beste Teiler 105.4 (34.) 110.9 (32.) 126.3 (40.)  
 Trefferlage 0.61 mm links, 0.03 mm tief  
 Streuwert 1.63, horizontal: 1.63, vertikal: 1.64

Unterschrift des Schützen

Meyton Elektronik

Ergebnis: **389.2** (371)  
 Serien: 97.6 95.9 97.8 97.9  
 Zähler: 16 20 3 1 0 0 0 0 0 0  
 Innenzehner: 10  
 weiteste: 1000 (11), 659 (10), 577 (32)  
 beste Teiler 5.3 (13.) 73.8 (33.) 78.3 (4.)  
 Trefferlage 0.40 mm rechts, 0.04 mm tief  
 Streuwert 2.52, horizontal: 3.06, vertikal: 1.85

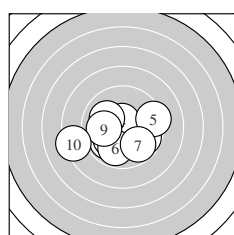
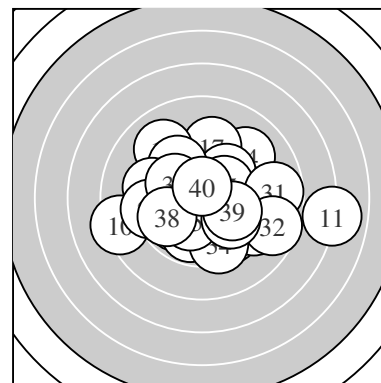

Serie 1:  
 9.9 ↙ 9.8 → 10.1 ↘ 10.6 \* 9.3 →  
 9.8 ↓ 9.8 ↘ 10.0 ↖ 10.0 ← 8.3 ←  
 beste Teiler 78.3 (4.) 214.9 (3.) 228.7 (8.)  
 Trefferlage 0.65 mm links, 0.87 mm tief  
 Streuwert 2.31, horizontal: 2.94, vertikal: 1.44

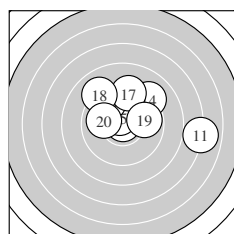

Serie 2:  
 7.0 → 10.4 \* 10.9 \* 9.1 ↗ 10.6 \*  
 9.6 ↘ 9.4 ↑ 9.1 ↘ 9.8 → 10.0 ←  
 beste Teiler 5.3 (13.) 88.6 (15.) 150.3 (12.)  
 Trefferlage 0.92 mm rechts, 1.54 mm hoch  
 Streuwert 2.93, horizontal: 3.75, vertikal: 1.77

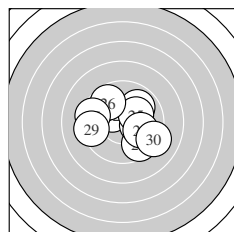

Serie 3:  
 9.6 ↘ 10.3 \* 9.9 ↗ 10.2 \* 10.2 \*  
 9.7 ↘ 9.4 ← 10.0 → 9.3 ← 9.2 ↘  
 beste Teiler 162.2 (22.) 189.0 (24.) 194.3 (25.)  
 Trefferlage 0.28 mm rechts, 0.00 mm  
 Streuwert 2.31, horizontal: 2.78, vertikal: 1.71

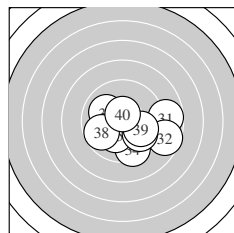

Serie 4:  
 8.8 → 8.6 → 10.7 \* 9.5 ↓ 10.2 \*  
 10.0 ↖ 9.9 ↘ 9.7 ← 9.9 → 10.6 \*  
 beste Teiler 73.8 (33.) 89.0 (40.) 197.2 (35.)  
 Trefferlage 1.05 mm rechts, 0.83 mm tief  
 Streuwert 2.27, horizontal: 2.83, vertikal: 1.54

Unterschrift des Schützen

Meyton Elektronik

Ergebnis: **393.0** (381)  
 Serien: 99.8 98.6 97.0 97.6  
 Zähler: 23 15 2 0 0 0 0 0 0 0  
 Innenzehner: 10  
 weiteste: 591 (33), 576 (28), 455 (30)  
 beste Teiler 60.5 (2.) 103.3 (6.) 126.6 (38.)  
 Trefferlage 0.07 mm links, 0.53 mm hoch  
 Streuwert 2.15, horizontal: 2.20, vertikal: 2.10

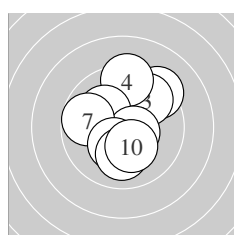
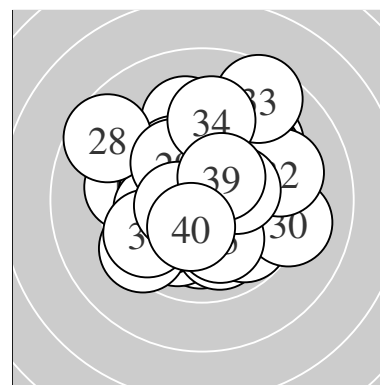

Serie 1:  
 9.3 ↗ 10.7 \* 9.7 ↗ 9.3 ↑ 10.1 ↘  
 10.5 \* 9.7 ← 10.3 \* 10.0 ↓ 10.2 \*  
 beste Teiler 60.5 (2.) 103.3 (6.) 161.9 (8.)  
 Trefferlage 0.14 mm rechts, 0.60 mm hoch  
 Streuwert 1.90, horizontal: 1.70, vertikal: 2.08

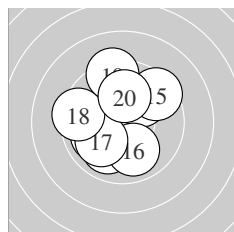

Serie 2:  
 10.3 \* 10.0 ↗ 10.0 ↘ 10.0 ← 9.5 ↗  
 10.0 ↓ 10.0 ← 9.4 ← 9.3 ↑ 10.1 ↑  
 beste Teiler 163.9 (11.) 221.5 (20.) 238.2 (17.)  
 Trefferlage 0.60 mm links, 0.35 mm hoch  
 Streuwert 2.09, horizontal: 1.97, vertikal: 2.20

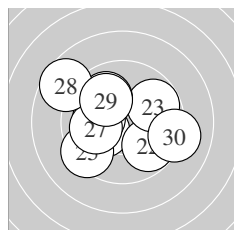

Serie 3:  
 10.2 \* 9.8 ↘ 9.8 ↗ 10.1 ← 9.4 ←  
 10.0 ↘ 10.0 ← 8.6 ↘ 10.0 ↘ 9.1 →  
 beste Teiler 180.2 (21.) 204.0 (24.) 232.5 (27.)  
 Trefferlage 0.74 mm links, 0.19 mm hoch  
 Streuwert 2.42, horizontal: 2.86, vertikal: 1.87

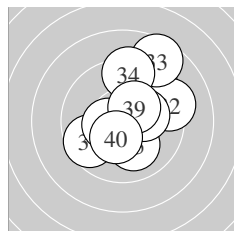

Serie 4:  
 9.4 ↗ 9.3 → 8.6 ↗ 9.3 ↑ 10.1 ↓  
 10.2 \* 9.6 ← 10.4 \* 10.3 \* 10.4 \*  
 beste Teiler 126.6 (38.) 148.9 (40.) 153.2 (39.)  
 Trefferlage 0.88 mm rechts, 0.99 mm hoch  
 Streuwert 2.26, horizontal: 2.03, vertikal: 2.47

Unterschrift des Schützen

Meyton Elektronik

Ergebnis: **401.8** (384)  
 Serien: 97.6 98.2 102.4 103.6  
 Zähler: 25 14 1 0 0 0 0 0 0 0  
 Innenzehner: 21  
 weiteste: 555 (19), 472 (3), 444 (4)  
 beste Teiler 37.9 (8.) 72.2 (34.) 78.9 (40.)  
 Trefferlage 0.02 mm rechts, 0.60 mm hoch  
 Streuwert 1.81, horizontal: 2.09, vertikal: 1.47

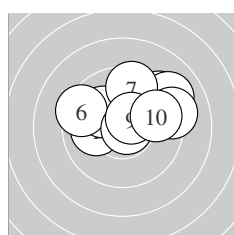
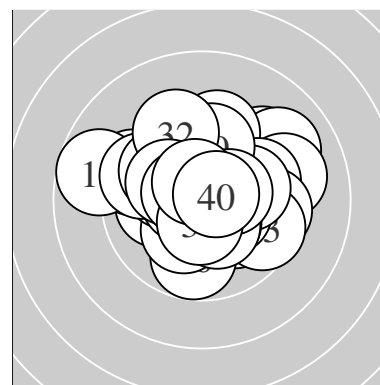

Serie 1:  
 10.0 ←                      9.3 ↗                      9.1 ↗                      9.2 →                      10.1 ↘  
 9.4 ↖                      9.5 ↑                      10.8 \*                      10.5 \*                      9.7 →  
 beste Teiler 37.9 (8.) 108.2 (9.) 215.2 (5.)  
 Trefferlage 0.86 mm rechts, 1.40 mm hoch  
 Streuwert 2.11, horizontal: 2.73, vertikal: 1.19

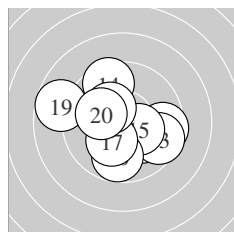

Serie 2:  
 10.1 ↘                      9.5 →                      9.6 ↘                      9.5 ↑                      10.3 \*  
 9.8 ↓                      10.2 \*                      10.3 \*                      8.7 ↖                      10.2 \*  
 beste Teiler 153.5 (15.) 163.0 (18.) 184.3 (17.)  
 Trefferlage 0.12 mm links, 0.16 mm tief  
 Streuwert 2.28, horizontal: 2.64, vertikal: 1.85

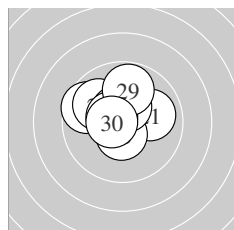

Serie 3:  
 10.0 →                      9.6 ↖                      10.6 \*                      9.9 ↖                      10.5 \*  
 10.5 \*                      10.4 \*                      10.5 \*                      9.8 ↑                      10.6 \*  
 beste Teiler 94.0 (30.) 96.6 (23.) 104.2 (28.)  
 Trefferlage 0.51 mm links, 0.86 mm hoch  
 Streuwert 1.27, horizontal: 1.48, vertikal: 1.01

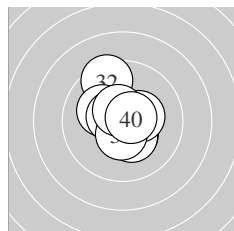

Serie 4:  
 10.4 \*                      9.4 ↖                      10.2 \*                      10.7 \*                      10.5 \*  
 10.3 \*                      10.4 \*                      10.5 \*                      10.6 \*                      10.6 \*  
 beste Teiler 72.2 (34.) 78.9 (40.) 100.0 (39.)  
 Trefferlage 0.14 mm links, 0.29 mm hoch  
 Streuwert 1.25, horizontal: 1.06, vertikal: 1.41

Unterschrift des Schützen

Ergebnis: **399.0** (380)  
 Serien: 97.1 100.4 101.7 99.8  
 Zähler: 23 14 3 0 0 0 0 0 0 0  
 Innenzehner: 12  
 weiteste: 692 (1), 542 (27), 516 (13)  
 beste Teiler 41.0 (22.) 62.6 (26.) 71.0 (37.)  
 Trefferlage 0.79 mm rechts, 0.24 mm hoch  
 Streuwert 1.93, horizontal: 2.43, vertikal: 1.23

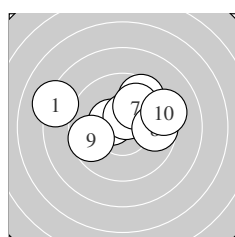
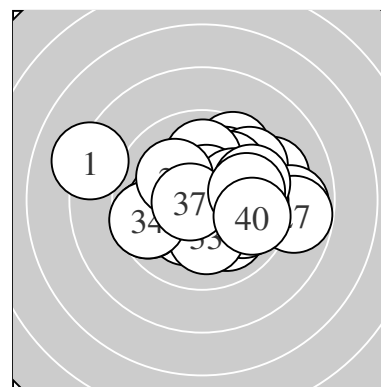

Serie 1:  
 8.2 ↖ 9.7 → 10.0 → 10.5 \* 9.6 ↗  
 10.5 \* 10.0 ↗ 9.7 → 9.7 ← 9.2 →  
 beste Teiler 110.3 (6.) 121.8 (4.) 240.5 (7.)  
 Trefferlage 0.51 mm rechts, 1.09 mm hoch  
 Streuwert 2.45, horizontal: 3.27, vertikal: 1.17

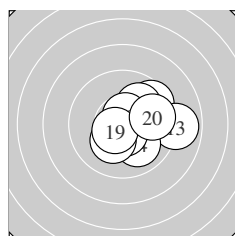

Serie 2:  
 10.1 → 9.6 ↗ 8.9 → 10.0 ↘ 10.6 \*  
 10.0 ↗ 10.2 \* 10.6 \* 10.6 \* 9.8 →  
 beste Teiler 85.3 (18.) 90.2 (15.) 96.5 (19.)  
 Trefferlage 1.48 mm rechts, 0.01 mm tief  
 Streuwert 1.62, horizontal: 1.87, vertikal: 1.32

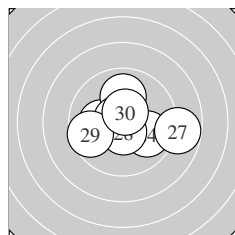

Serie 3:  
 10.6 \* 10.8 \* 10.1 ← 9.9 ↘ 10.0 ↑  
 10.7 \* 8.8 → 10.6 \* 9.6 ← 10.6 \*  
 beste Teiler 41.0 (22.) 62.6 (26.) 95.4 (28.)  
 Trefferlage 0.16 mm rechts, 0.01 mm tief  
 Streuwert 1.84, horizontal: 2.35, vertikal: 1.13

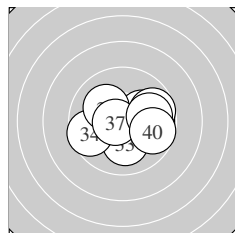

Serie 4:  
 9.8 → 10.1 → 10.1 ↓ 9.6 ← 10.1 →  
 10.1 ↖ 10.7 \* 9.7 → 9.9 → 9.7 →  
 beste Teiler 71.0 (37.) 201.3 (32.) 207.4 (36.)  
 Trefferlage 1.00 mm rechts, 0.08 mm tief  
 Streuwert 1.72, horizontal: 2.18, vertikal: 1.06

Unterschrift des Schützen

Meyton Elektronik

Ergebnis:	<b>403.5</b>	(384)
Serien:	102.1	100.9 100.5 100.0
Zähler:	24	16 0 0 0 0 0 0 0 0
Innenzehner:	17	
weiteste:	497 (27),	452 (13), 404 (34)
beste Teiler	41.8 (10.)	44.1 (14.) 52.4 (30.)
Trefferlage	0.26 mm	rechts, 0.18 mm hoch
Streuwert	1.75,	horizontal: 2.12, vertikal: 1.29

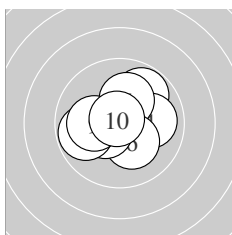
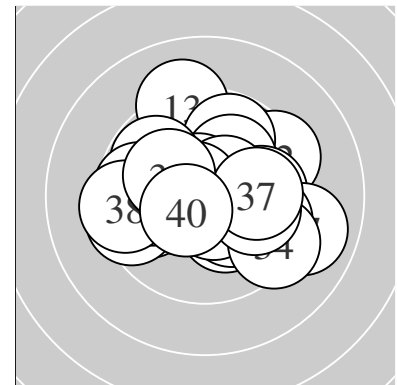

Serie 1:	10.7 *	10.1 ←	9.8 ↗	10.0 →	10.2 *
	10.2 *	10.4 *	9.8 ←	10.1 ←	10.8 *
beste Teiler	41.8 (10.)	53.7 (1.)	131.5 (7.)		
Trefferlage	0.29 mm links, 0.11 mm hoch				
Streuwert	1.47, horizontal: 1.74, vertikal: 1.15				

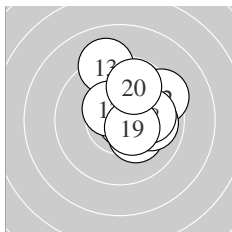

Serie 2:	10.7 *	9.4 ↗	9.1 ↑	10.8 *	10.2 *
	9.9 →	10.5 *	10.0 →	10.5 *	9.8 ↑
beste Teiler	44.1 (14.)	74.4 (11.)	118.3 (19.)		
Trefferlage	1.08 mm rechts, 0.87 mm hoch				
Streuwert	1.56, horizontal: 1.41, vertikal: 1.69				

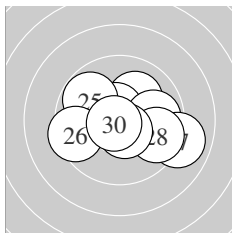

Serie 3:	10.1 ↗	10.6 *	10.6 *	9.9 →	9.8 ↘
	9.5 ←	9.0 →	9.7 →	10.6 *	10.7 *
beste Teiler	52.4 (30.)	86.1 (23.)	90.6 (22.)		
Trefferlage	0.62 mm rechts, 0.09 mm tief				
Streuwert	1.95, horizontal: 2.49, vertikal: 1.18				

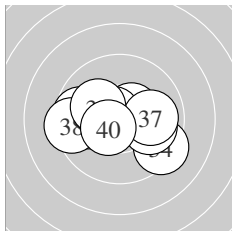

Serie 4:	10.5 *	9.7 ←	9.9 ←	9.3 ↘	10.0 →
	10.7 *	9.9 →	9.4 ←	10.1 ↘	10.5 *
beste Teiler	67.2 (36.)	115.6 (40.)	118.2 (31.)		
Trefferlage	0.36 mm links, 0.17 mm tief				
Streuwert	1.93, horizontal: 2.56, vertikal: 0.93				

Unterschrift des Schützen