

Ergebnis: **175.6** (170)
 Serien: 90.3 85.3
 Zähler: 5 7 4 2 1 1 0 0 0 0
 Innenzehner: 1
 weiteste: 1436 (17), 1053 (16), 962 (9)
 beste Teiler 199.9 (5.) 203.0 (14.) 209.0 (11.)
 Trefferlage 0.22 mm rechts, 0.31 mm hoch
 Streuwert 4.56, horizontal: 6.06, vertikal: 2.21

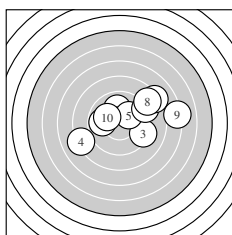

Serie 1:
 10.0 ↑ 9.8 ← 9.3 ➤ 8.1 ← 10.2 *
 9.0 ↗ 8.2 ↗ 8.6 ↗ 7.1 → 10.0 ↖
 beste Teiler 199.9 (5.) 228.0 (10.) 243.3 (1.)
 Trefferlage 1.78 mm rechts, 1.14 mm hoch
 Streuwert 3.68, horizontal: 4.72, vertikal: 2.20

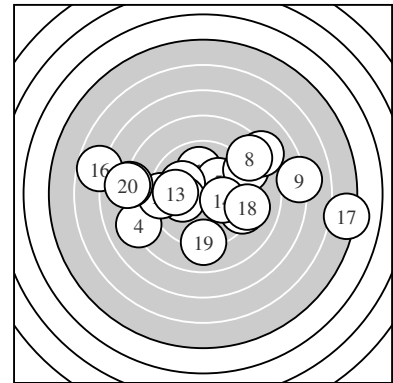
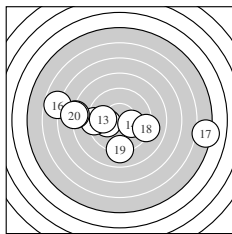

Serie 2:
 10.1 ← 9.3 ← 9.9 ← 10.1 ➤ 8.0 ←
 6.7 ← 5.2 ➤ 9.1 ➤ 9.0 ↓ 7.9 ←
 beste Teiler 203.0 (14.) 209.0 (11.) 273.3 (13.)
 Trefferlage 1.33 mm links, 0.51 mm tief
 Streuwert 5.19, horizontal: 7.06, vertikal: 1.98

Unterschrift des Schützen

Ergebnis: **186.7** (178)
 Serien: 94.3 92.4
 Zähler: 5 10 3 2 0 0 0 0 0 0
 Innenzehner: 4
 weiteste: 965 (17), 938 (9), 742 (20)
 beste Teiler 57.3 (7.) 87.3 (4.) 137.8 (15.)
 Trefferlage 0.26 mm links, 1.98 mm hoch
 Streuwert 3.12, horizontal: 3.83, vertikal: 2.18

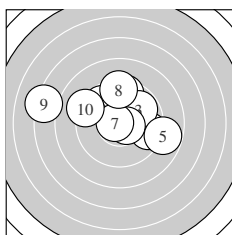
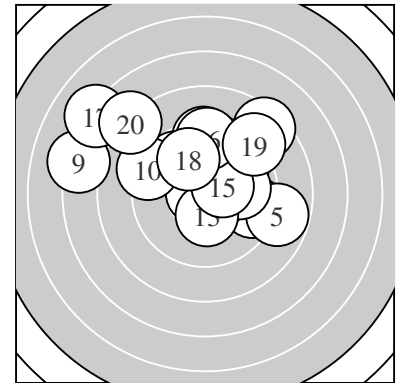

Serie 1:
 9.5 ↑ 9.5 → 9.8 ↗ 10.6 * 8.8 →
 9.7 ↘ 10.7 * 9.3 ↑ 7.2 ← 9.2 ←
 beste Teiler 57.3 (7.) 87.3 (4.) 283.0 (3.)
 Trefferlage 0.36 mm links, 1.29 mm hoch
 Streuwert 3.16, horizontal: 4.05, vertikal: 1.88

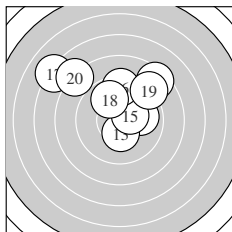

Serie 2:
 9.9 → 8.4 ↗ 10.3 * 10.1 ↗ 10.4 *
 9.4 ↑ 7.1 ↘ 9.8 ↘ 9.0 ↗ 8.0 ↘
 beste Teiler 137.8 (15.) 152.5 (13.) 205.2 (14.)
 Trefferlage 0.16 mm links, 2.66 mm hoch
 Streuwert 3.16, horizontal: 3.82, vertikal: 2.33

Unterschrift des Schützen

Ergebnis: **175.8** (166)
 Serien: 87.0 88.8
 Zähler: 5 3 7 4 0 1 0 0 0 0
 Innenzehner: 4
 weiteste: 1294 (3), 982 (2), 889 (12)
 beste Teiler 143.0 (4.) 149.4 (14.) 151.7 (8.)
 Trefferlage 1.69 mm links, 0.50 mm hoch
 Streuwert 4.33, horizontal: 5.94, vertikal: 1.52

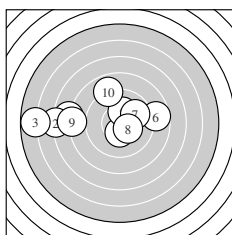
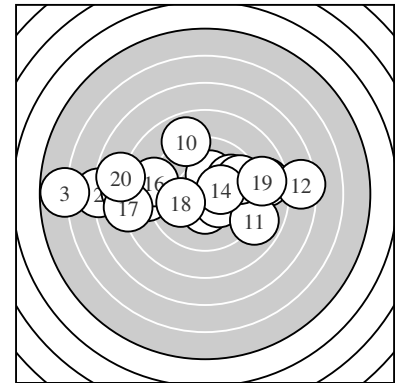

Serie 1:
 7.8 ← 7.0 ← 5.8 ← 10.4 * 10.2 *
 8.7 → 9.9 ↗ 10.3 * 8.0 ← 8.9 ↖
 beste Teiler 143.0 (4.) 151.7 (8.) 182.8 (5.)
 Trefferlage 2.99 mm links, 0.83 mm hoch
 Streuwert 4.45, horizontal: 6.06, vertikal: 1.71

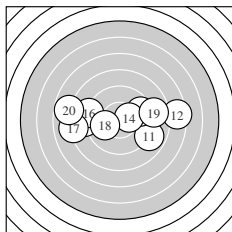

Serie 2:
 8.9 ↘ 7.4 → 9.6 ↗ 10.4 * 8.8 ←
 9.0 ← 8.1 ← 10.0 ← 8.8 → 7.8 ←
 beste Teiler 149.4 (14.) 238.4 (18.) 348.9 (13.)
 Trefferlage 0.39 mm links, 0.17 mm hoch
 Streuwert 4.22, horizontal: 5.82, vertikal: 1.32

Unterschrift des Schützen

Ergebnis: **191.5** (182)
 Serien: 92.7 98.8
 Zähler: 7 10 2 0 1 0 0 0 0 0
 Innenzehner: 5
 weiteste: 1007 (2), 675 (4), 594 (16)
 beste Teiler 43.0 (20.) 84.5 (17.) 95.2 (15.)
 Trefferlage 1.24 mm links, 0.06 mm tief
 Streuwert 2.85, horizontal: 3.58, vertikal: 1.84

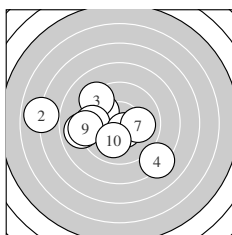
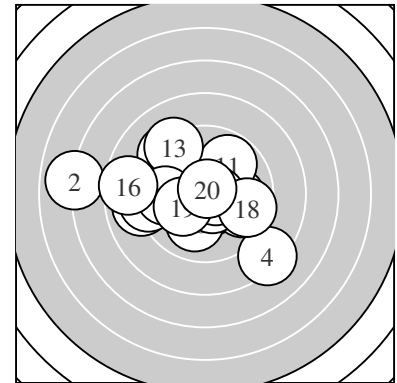

Serie 1:
 9.9 ↘ 6.9 ← 9.3 ↘ 8.3 ↘ 9.6 ←
 10.5 * 10.0 → 9.0 ← 9.2 ← 10.0 ↓
 beste Teiler 107.3 (6.) 230.9 (10.) 235.9 (7.)
 Trefferlage 2.11 mm links, 0.41 mm tief
 Streuwert 3.29, horizontal: 4.14, vertikal: 2.12

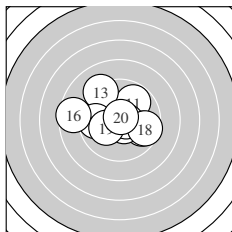

Serie 2:
 9.8 ↗ 9.7 → 9.2 ↘ 9.7 ← 10.6 *
 8.6 ← 10.6 * 9.6 → 10.2 * 10.8 *
 beste Teiler 43.0 (20.) 84.5 (17.) 95.2 (15.)
 Trefferlage 0.37 mm links, 0.27 mm hoch
 Streuwert 2.31, horizontal: 2.87, vertikal: 1.56

Unterschrift des Schützen

Ergebnis: **184.4** (176)
 Serien: 90.3 94.1
 Zähler: 3 12 3 2 0 0 0 0 0 0
 Innenzehner: 2
 weiteste: 1000 (10), 868 (8), 584 (12)
 beste Teiler 131.7 (5.) 163.6 (17.) 239.2 (15.)
 Trefferlage 0.41 mm rechts, 0.87 mm hoch
 Streuwert 3.41, horizontal: 4.51, vertikal: 1.71

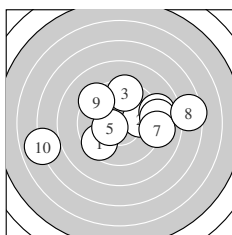
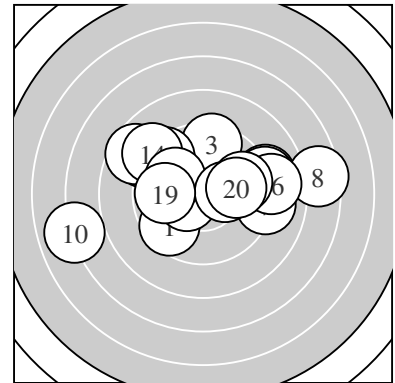

Serie 1:
 9.6 ↙ 9.9 → 9.4 ↑ 9.0 → 10.4 *
 9.0 → 9.1 → 7.5 → 9.4 ↘ 7.0 ←
 beste Teiler 131.7 (5.) 261.0 (2.) 343.1 (1.)
 Trefferlage 0.96 mm rechts, 0.39 mm hoch
 Streuwert 3.97, horizontal: 5.21, vertikal: 2.09

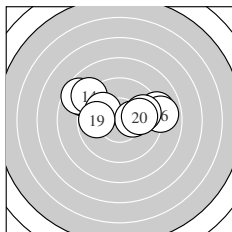

Serie 2:
 8.9 ↘ 8.6 ↘ 9.0 → 9.0 ↘ 10.0 ↘
 8.9 → 10.3 * 9.7 → 9.8 ← 9.9 →
 beste Teiler 163.6 (17.) 239.2 (15.) 251.2 (20.)
 Trefferlage 0.13 mm links, 1.34 mm hoch
 Streuwert 2.85, horizontal: 3.87, vertikal: 1.14

Unterschrift des Schützen

Ergebnis: **184.0** (177)
 Serien: 90.4 93.6
 Zähler: 6 7 5 2 0 0 0 0 0 0
 Innenzehner: 3
 weiteste: 818 (11), 798 (5), 700 (7)
 beste Teiler 177.1 (13.) 192.8 (14.) 193.2 (12.)
 Trefferlage 0.99 mm links, 1.60 mm hoch
 Streuwert 3.21, horizontal: 4.17, vertikal: 1.78

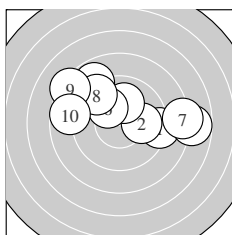
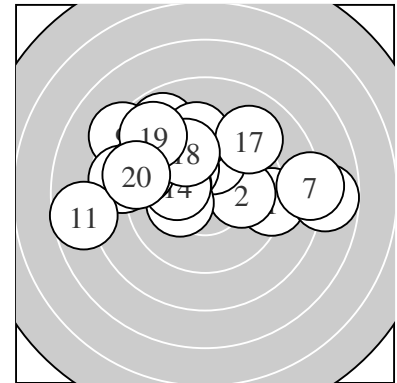

Serie 1:
 9.2 → 10.0 → 8.8 ↘ 10.0 ↑ 7.8 →
 10.1 ↘ 8.2 → 9.3 ↘ 8.3 ↘ 8.7 ←
 beste Teiler 215.2 (6.) 227.3 (4.) 243.0 (2.)
 Trefferlage 0.46 mm rechts, 1.61 mm hoch
 Streuwert 3.65, horizontal: 4.86, vertikal: 1.77

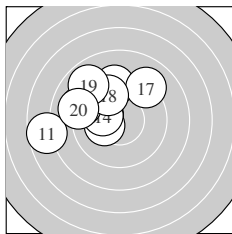

Serie 2:
 7.7 ← 10.2 * 10.2 * 10.2 * 9.4 ↑
 9.1 ↘ 9.1 ↗ 9.7 ↘ 8.9 ↘ 9.1 ←
 beste Teiler 177.1 (13.) 192.8 (14.) 193.2 (12.)
 Trefferlage 2.45 mm links, 1.60 mm hoch
 Streuwert 2.44, horizontal: 2.89, vertikal: 1.88

Unterschrift des Schützen

Ergebnis: **188.2** (177)
 Serien: 96.3 91.9
 Zähler: 7 4 8 1 0 0 0 0 0 0
 Innenzehner: 3
 weiteste: 767 (3), 587 (16), 575 (13)
 beste Teiler 87.3 (9.) 114.5 (10.) 155.5 (1.)
 Trefferlage 1.23 mm rechts, 0.63 mm tief
 Streuwert 2.98, horizontal: 3.62, vertikal: 2.15

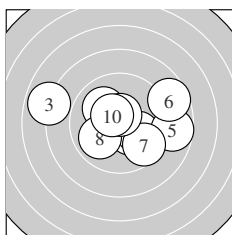
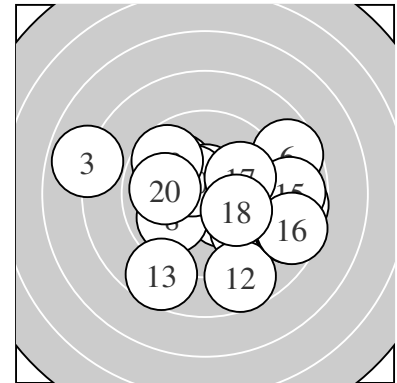

Serie 1:
 10.3 * 10.0 ↘ 7.9 ← 10.1 ↘ 8.7 →
 8.7 ↗ 9.6 ↘ 9.9 ↙ 10.6 * 10.5 *
 beste Teiler 87.3 (9.) 114.5 (10.) 155.5 (1.)
 Trefferlage 0.44 mm rechts, 0.12 mm hoch
 Streuwert 2.92, horizontal: 3.79, vertikal: 1.63

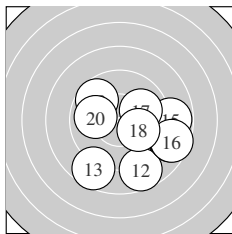

Serie 2:
 8.7 ↘ 8.7 ↓ 8.7 ↙ 8.7 ↘ 8.8 →
 8.6 ↗ 10.0 → 10.1 ↘ 9.7 ↘ 9.9 ←
 beste Teiler 222.3 (18.) 244.7 (17.) 254.1 (20.)
 Trefferlage 2.01 mm rechts, 1.40 mm tief
 Streuwert 2.98, horizontal: 3.45, vertikal: 2.42

Unterschrift des Schützen

Ergebnis: **196.6** (187)
 Serien: 100.1 96.5
 Zähler: 9 9 2 0 0 0 0 0 0 0
 Innenzehner: 6
 weiteste: 614 (19), 611 (8), 467 (11)
 beste Teiler 47.0 (3.) 48.8 (20.) 89.2 (1.)
 Trefferlage 0.21 mm rechts, 0.50 mm tief
 Streuwert 2.35, horizontal: 3.10, vertikal: 1.20

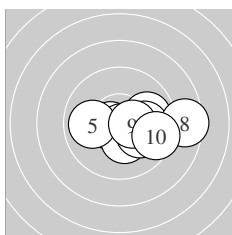
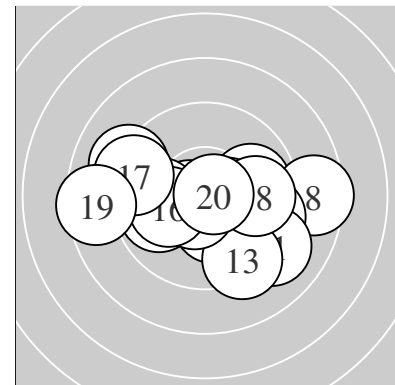

Serie 1:
 10.6 * 9.9 → 10.8 * 10.3 * 9.9 ←
 10.0 → 10.1 ↘ 8.5 → 10.5 * 9.5 ↘
 beste Teiler 47.0 (3.) 89.2 (1.) 121.3 (9.)
 Trefferlage 1.48 mm rechts, 0.40 mm tief
 Streuwert 1.75, horizontal: 2.39, vertikal: 0.65

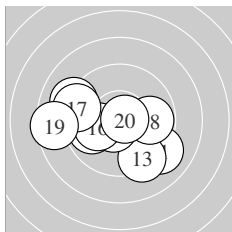

Serie 2:
 9.1 ↘ 9.9 ← 9.3 ↘ 9.1 ↖ 10.6 *
 10.1 ← 9.3 ← 9.8 → 8.5 ← 10.8 *
 beste Teiler 48.8 (20.) 94.8 (15.) 213.8 (16.)
 Trefferlage 1.05 mm links, 0.61 mm tief
 Streuwert 2.60, horizontal: 3.31, vertikal: 1.60

Unterschrift des Schützen

Ergebnis: **199.6** (191)
 Serien: 99.8 99.8
 Zähler: 11 9 0 0 0 0 0 0 0 0
 Innenzehner: 9
 weiteste: 470 (2), 414 (19), 391 (7)
 beste Teiler 86.2 (12.) 86.3 (4.) 107.7 (13.)
 Trefferlage 0.25 mm rechts, 0.72 mm hoch
 Streuwert 1.85, horizontal: 2.35, vertikal: 1.14

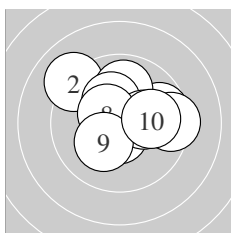
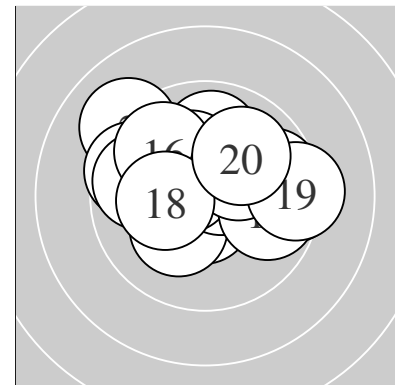

Serie 1:
 9.7 → 9.1 ↘ 9.9 ↑ 10.6 * 10.2 *
 10.2 * 9.4 → 10.5 * 10.2 * 10.0 →
 beste Teiler 86.3 (4.) 120.6 (8.) 178.2 (5.)
 Trefferlage 0.50 mm rechts, 0.73 mm hoch
 Streuwert 1.89, horizontal: 2.26, vertikal: 1.41

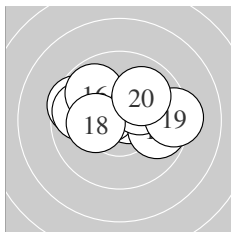

Serie 2:
 9.6 ↖ 10.6 * 10.5 * 9.8 → 9.8 ↖
 9.8 ↘ 10.2 * 10.2 * 9.3 → 10.0 ↗
 beste Teiler 86.2 (12.) 107.7 (13.) 183.3 (18.)
 Trefferlage 0.00 mm , 0.71 mm hoch
 Streuwert 1.89, horizontal: 2.54, vertikal: 0.85

Unterschrift des Schützen

Ergebnis: **194.2** (187)
 Serien: 95.9 98.3
 Zähler: 9 9 2 0 0 0 0 0 0 0
 Innenzehner: 4
 weiteste: 634 (3), 619 (16), 469 (1)
 beste Teiler 91.5 (5.) 123.3 (15.) 124.6 (6.)
 Trefferlage 0.34 mm links, 0.52 mm hoch
 Streuwert 2.48, horizontal: 2.73, vertikal: 2.21

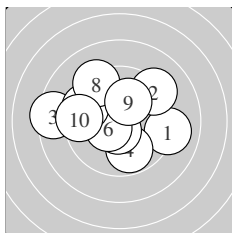
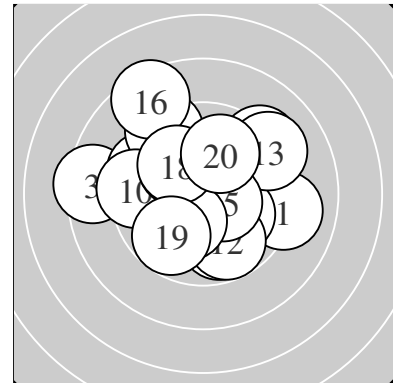

Serie 1:
 9.1 → 9.2 ↗ 8.4 ← 9.8 ↓ 10.6 *
 10.5 * 9.5 ↖ 9.3 ↘ 10.1 ↑ 9.4 ←
 beste Teiler 91.5 (5.) 124.6 (6.) 202.7 (9.)
 Trefferlage 0.72 mm links, 0.53 mm hoch
 Streuwert 2.71, horizontal: 3.32, vertikal: 1.92

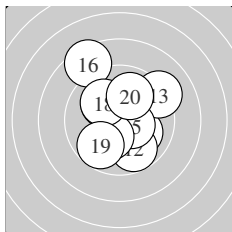

Serie 2:
 10.1 ↘ 9.8 ↓ 9.2 ↗ 10.1 ↘ 10.5 *
 8.5 ↘ 10.2 * 10.1 ↘ 9.8 ↗ 10.0 ↑
 beste Teiler 123.3 (15.) 178.2 (17.) 212.9 (14.)
 Trefferlage 0.03 mm rechts, 0.51 mm hoch
 Streuwert 2.34, horizontal: 2.08, vertikal: 2.58

Unterschrift des Schützen

LG 20 ZR – Wertung – Juniors weibl.

StartNr: 41

StandNr: 141

29. Februar 2020 10:05

Egger,, Hannah #70233126

SG_Thaur / SG Thaur 1

Ergebnis: **190.3** (180)
 Serien: 91.3 99.0
 Zähler: 5 11 3 1 0 0 0 0 0 0
 Innenzehner: 5
 weiteste: 761 (6), 665 (2), 641 (9)
 beste Teiler 50.2 (15.) 70.0 (1.) 86.6 (18.)
 Trefferlage 0.02 mm rechts, 1.73 mm hoch
 Streuwert 2.68, horizontal: 3.45, vertikal: 1.55

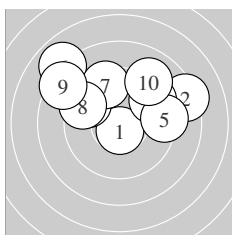
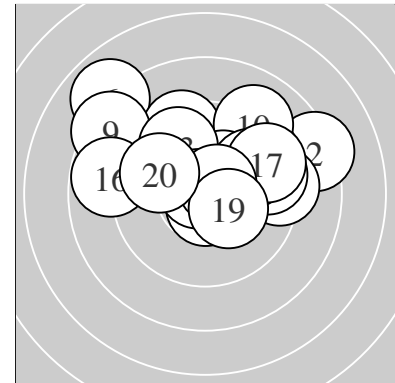

Serie 1:
 10.7 * 8.3 → 9.5 ↖ 9.4 ↗ 9.3 →
 7.9 ↘ 9.4 ↖ 9.4 ↖ 8.4 ↖ 9.0 ↗
 beste Teiler 70.0 (1.) 352.6 (3.) 381.4 (4.)
 Trefferlage 0.22 mm links, 2.43 mm hoch
 Streuwert 3.18, horizontal: 4.13, vertikal: 1.77

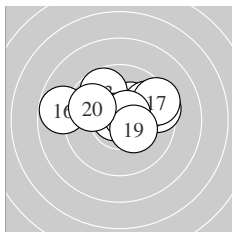

Serie 2:
 10.3 * 9.5 → 9.7 ↖ 9.8 ↗ 10.8 *
 8.8 ← 9.4 → 10.6 * 10.3 * 9.8 ↖
 beste Teiler 50.2 (15.) 86.6 (18.) 155.9 (19.)
 Trefferlage 0.27 mm rechts, 1.04 mm hoch
 Streuwert 2.10, horizontal: 2.82, vertikal: 0.93

Unterschrift des Schützen

Meyton Elektronik

Ergebnis: **177.3** (166)
 Serien: 88.6 88.7
 Zähler: 1 11 3 3 2 0 0 0 0 0
 Innenzehner: 1
 weiteste: 1162 (3), 1075 (18), 899 (11)
 beste Teiler 97.9 (14.) 252.9 (20.) 258.3 (6.)
 Trefferlage 1.73 mm links, 0.31 mm hoch
 Streuwert 4.15, horizontal: 5.68, vertikal: 1.49

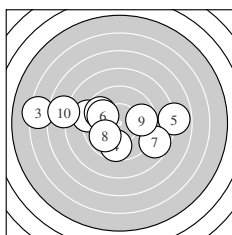
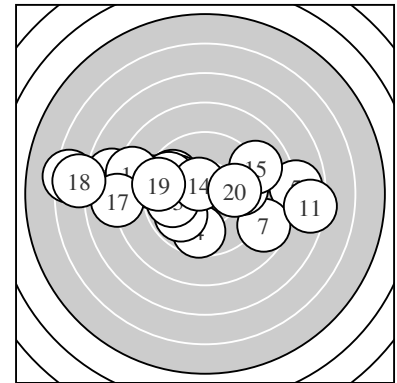

Serie 1:
 9.1 ← 9.7 ↖ 6.3 ← 9.7 ↓ 7.9 →
 9.9 ↖ 8.7 ↘ 9.9 ↗ 9.7 → 7.7 ←
 beste Teiler 258.3 (6.) 272.1 (8.) 311.8 (2.)
 Trefferlage 1.58 mm links, 0.01 mm hoch
 Streuwert 4.29, horizontal: 5.79, vertikal: 1.82

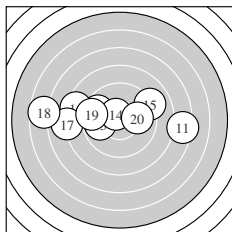

Serie 2:
 7.4 → 9.6 ↖ 9.8 ← 10.6 * 9.0 ↗
 8.4 ← 8.0 ← 6.7 ← 9.3 ← 9.9 →
 beste Teiler 97.9 (14.) 252.9 (20.) 280.8 (13.)
 Trefferlage 1.88 mm links, 0.62 mm hoch
 Streuwert 4.22, horizontal: 5.86, vertikal: 1.07

Unterschrift des Schützen

Ergebnis: **181.8** (173)
 Serien: 89.2 92.6
 Zähler: 4 8 5 3 0 0 0 0 0 0
 Innenzehner: 2
 weiteste: 882 (4), 837 (9), 773 (17)
 beste Teiler 109.7 (16.) 200.4 (10.) 233.0 (8.)
 Trefferlage 2.63 mm rechts, 0.42 mm hoch
 Streuwert 3.24, horizontal: 3.46, vertikal: 2.99

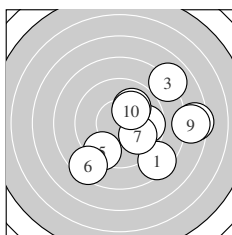
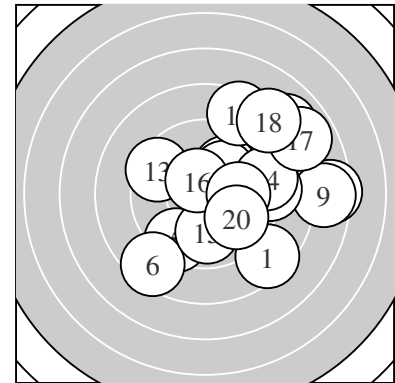

Serie 1:
 8.5 ↘ 9.7 → 8.0 ↗ 7.4 → 9.4 ↙
 8.5 ↙ 9.9 ↘ 10.0 ↗ 7.6 → 10.2 *
 beste Teiler 200.4 (10.) 233.0 (8.) 254.3 (7.)
 Trefferlage 2.95 mm rechts, 0.59 mm tief
 Streuwert 3.57, horizontal: 4.05, vertikal: 3.01

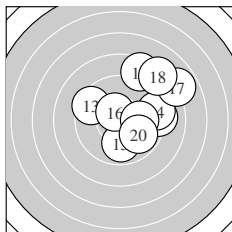

Serie 2:
 8.5 ↗ 9.1 → 9.4 ↖ 9.2 → 9.9 ↓
 10.5 * 7.9 ↗ 8.2 ↗ 10.0 → 9.9 ↘
 beste Teiler 109.7 (16.) 235.0 (19.) 266.4 (15.)
 Trefferlage 2.32 mm rechts, 1.44 mm hoch
 Streuwert 2.84, horizontal: 2.94, vertikal: 2.75

Unterschrift des Schützen

Ergebnis: **175.9** (168)
 Serien: 95.1 80.8
 Zähler: 3 11 3 1 1 0 0 0 1 0
 Innenzehner: 3
 weiteste: 2162 (18), 1106 (20), 844 (17)
 beste Teiler 82.3 (3.) 137.9 (15.) 188.8 (5.)
 Trefferlage 0.07 mm links, 3.93 mm tief
 Streuwert 4.18, horizontal: 2.11, vertikal: 5.52

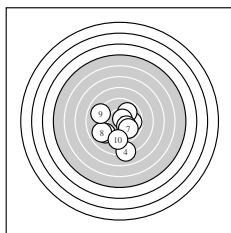
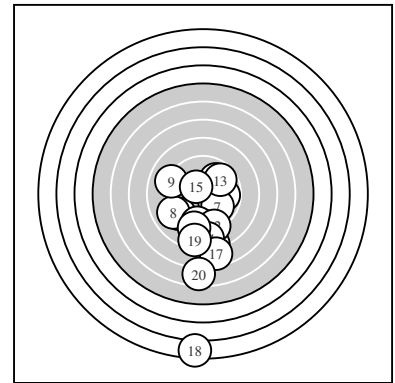

Serie 1:
 9.8 → 9.9 ↗ 10.6 * 8.1 ↓ 10.2 *
 9.2 ↙ 9.9 ↘ 9.0 ↖ 9.1 ← 9.3 ↓
 beste Teiler 82.3 (3.) 188.8 (5.) 261.1 (7.)
 Trefferlage 0.19 mm links, 1.51 mm tief
 Streuwert 2.74, horizontal: 2.72, vertikal: 2.76

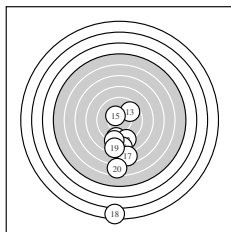

Serie 2:
 9.3 ↓ 9.1 ↓ 9.7 ↗ 8.5 ↓ 10.4 *
 9.0 ↓ 7.6 ↓ 2.3 ↓ 8.4 ↓ 6.5 ↓
 beste Teiler 137.9 (15.) 308.3 (13.) 406.1 (11.)
 Trefferlage 0.04 mm rechts, 6.35 mm tief
 Streuwert 4.78, horizontal: 1.40, vertikal: 6.61

Unterschrift des Schützen

Ergebnis: **194.5** (188)
 Serien: 96.4 98.1
 Zähler: 11 6 3 0 0 0 0 0 0 0
 Innenzehner: 8
 weiteste: 616 (8), 540 (7), 538 (16)
 beste Teiler 116.2 (13.) 122.7 (1.) 160.3 (3.)
 Trefferlage 0.15 mm rechts, 0.03 mm hoch
 Streuwert 2.49, horizontal: 3.34, vertikal: 1.11

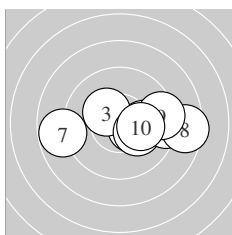
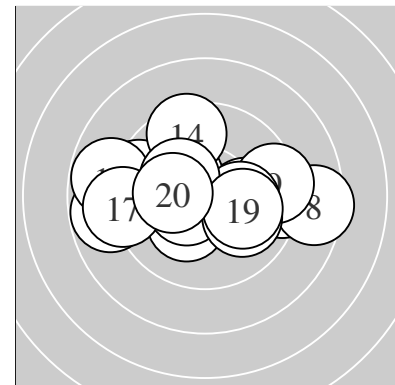

Serie 1:
 10.5 * 10.0 → 10.3 * 10.2 * 9.3 →
 9.2 → 8.8 ← 8.5 → 9.4 → 10.2 *
 beste Teiler 122.7 (1.) 160.3 (3.) 184.2 (4.)
 Trefferlage 1.89 mm rechts, 0.13 mm tief
 Streuwert 2.35, horizontal: 3.26, vertikal: 0.63

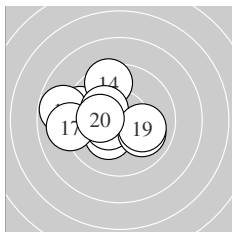

Serie 2:
 9.4 ← 10.2 * 10.5 * 9.5 ↑ 10.0 ↘
 8.8 ← 9.1 ← 10.3 * 10.1 → 10.2 *
 beste Teiler 116.2 (13.) 173.9 (18.) 177.6 (12.)
 Trefferlage 1.57 mm links, 0.20 mm hoch
 Streuwert 2.04, horizontal: 2.49, vertikal: 1.47

Unterschrift des Schützen

Ergebnis: **157.8** (148)
 Serien: 82.8 75.0
 Zähler: 2 6 1 5 1 5 0 0 0 0
 Innenzehner: 2
 weiteste: 1382 (13), 1382 (20), 1315 (2)
 beste Teiler 110.5 (7.) 121.6 (4.) 295.1 (3.)
 Trefferlage 0.48 mm rechts, 2.08 mm hoch
 Streuwert 6.19, horizontal: 8.39, vertikal: 2.47

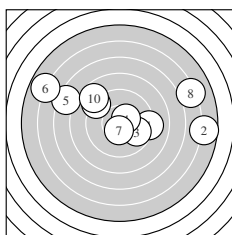
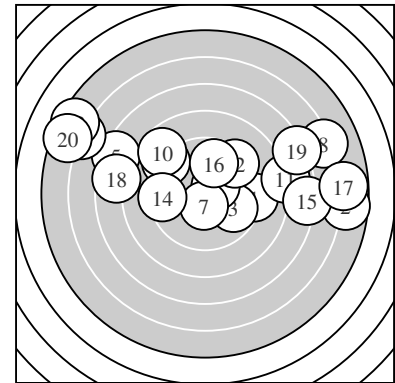

Serie 1:
 9.1 → 5.7 → 9.8 ↘ 10.5 * 7.3 ↖
 5.9 ↖ 10.5 * 6.2 ↗ 9.1 ↖ 8.7 ↖
 beste Teiler 110.5 (7.) 121.6 (4.) 295.1 (3.)
 Trefferlage 0.47 mm rechts, 1.75 mm hoch
 Streuwert 5.84, horizontal: 7.83, vertikal: 2.65

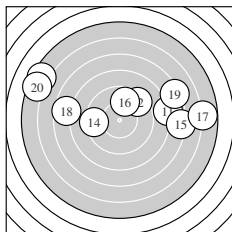

Serie 2:
 7.9 → 9.4 ↗ 5.4 ↖ 9.4 ← 7.1 →
 9.8 ↑ 5.8 → 7.6 ← 7.2 ↗ 5.4 ↖
 beste Teiler 297.8 (16.) 396.7 (12.) 399.2 (14.)
 Trefferlage 0.49 mm rechts, 2.42 mm hoch
 Streuwert 6.82, horizontal: 9.35, vertikal: 2.37

Unterschrift des Schützen

Ergebnis: **169.2** (161)
 Serien: 82.3 86.9
 Zähler: 0 8 7 4 0 1 0 0 0 0
 Innenzehner: 0
 weiteste: 1369 (7), 921 (4), 898 (11)
 beste Teiler 293.5 (9.) 314.1 (13.) 350.9 (19.)
 Trefferlage 0.18 mm links, 0.74 mm hoch
 Streuwert 4.90, horizontal: 6.70, vertikal: 1.76

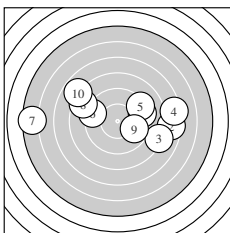
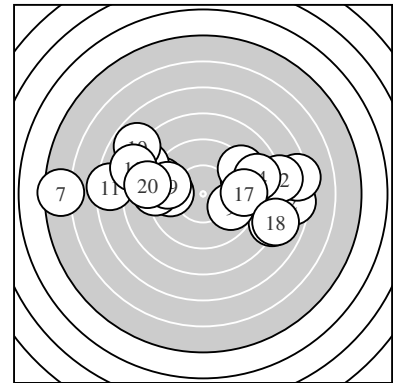

Serie 1:
 9.3 → 7.5 → 8.1 ↘ 7.3 → 9.2 ↗
 9.3 ← 5.5 ← 8.5 ↖ 9.8 ↘ 7.8 ↖
 beste Teiler 293.5 (9.) 415.5 (1.) 423.4 (6.)
 Trefferlage 0.50 mm rechts, 0.92 mm hoch
 Streuwert 5.53, horizontal: 7.52, vertikal: 2.14

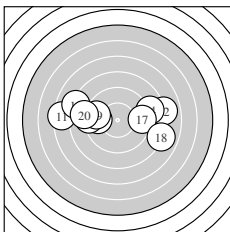

Serie 2:
 7.4 ← 8.0 → 9.7 ← 8.8 → 8.1 ↖
 9.1 ← 9.4 → 8.0 ↘ 9.6 ← 8.8 ←
 beste Teiler 314.1 (13.) 350.9 (19.) 394.2 (17.)
 Trefferlage 0.86 mm links, 0.56 mm hoch
 Streuwert 4.42, horizontal: 6.09, vertikal: 1.38

Unterschrift des Schützen

Ergebnis: **202.6** (193)
 Serien: 100.6 102.0
 Zähler: 13 7 0 0 0 0 0 0 0 0
 Innenzehner: 11
 weiteste: 473 (8), 403 (20), 391 (3)
 beste Teiler 31.8 (17.) 47.4 (14.) 73.5 (6.)
 Trefferlage 0.37 mm links, 0.43 mm hoch
 Streuwert 1.72, horizontal: 1.90, vertikal: 1.52

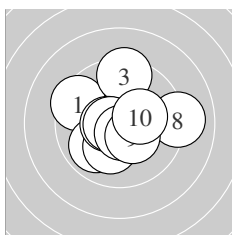
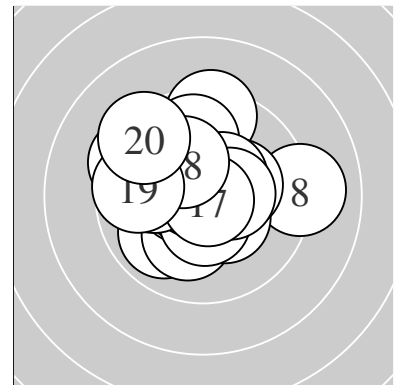

Serie 1:
 9.5 ↘ 9.9 ↙ 9.4 ↑ 10.1 ↓ 10.6 *
 10.7 * 10.6 * 9.1 → 10.4 * 10.3 *
 beste Teiler 73.5 (6.) 80.2 (7.) 98.2 (5.)
 Trefferlage 0.02 mm rechts, 0.07 mm hoch
 Streuwert 1.97, horizontal: 2.20, vertikal: 1.72

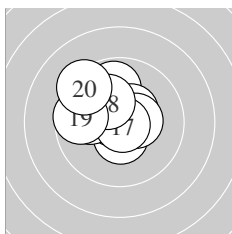

Serie 2:
 9.9 ↑ 10.5 * 10.4 * 10.8 * 10.4 *
 10.0 ← 10.8 * 10.2 * 9.7 ← 9.3 ↘
 beste Teiler 31.8 (17.) 47.4 (14.) 117.3 (12.)
 Trefferlage 0.77 mm links, 0.79 mm hoch
 Streuwert 1.42, horizontal: 1.56, vertikal: 1.27

Unterschrift des Schützen

Ergebnis: **188.5** (180)
 Serien: 94.4 94.1
 Zähler: 4 13 2 1 0 0 0 0 0 0
 Innenzehner: 2
 weiteste: 817 (13), 673 (2), 546 (10)
 beste Teiler 130.5 (4.) 194.6 (18.) 220.8 (16.)
 Trefferlage 1.05 mm rechts, 1.94 mm tief
 Streuwert 2.55, horizontal: 3.37, vertikal: 1.27

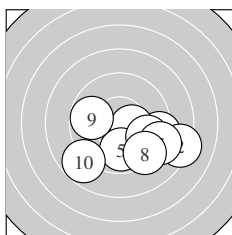
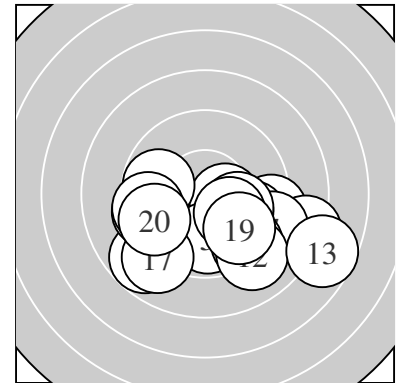

Serie 1:
 9.2 ➤ 8.3 ➤ 9.9 ↘ 10.4 * 9.9 ↓
 9.7 ➤ 9.1 ➤ 9.3 ↘ 9.8 ← 8.8 ↙
 beste Teiler 130.5 (4.) 266.2 (3.) 274.4 (5.)
 Trefferlage 1.64 mm rechts, 1.87 mm tief
 Streuwert 2.42, horizontal: 3.15, vertikal: 1.34

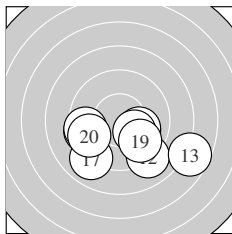

Serie 2:
 10.0 ➤ 9.0 ↘ 7.7 ➤ 9.4 ← 9.5 ←
 10.1 ➤ 9.0 ↙ 10.2 * 9.7 ↘ 9.5 ←
 beste Teiler 194.6 (18.) 220.8 (16.) 229.4 (11.)
 Trefferlage 0.47 mm rechts, 2.02 mm tief
 Streuwert 2.73, horizontal: 3.65, vertikal: 1.27

Unterschrift des Schützen

Ergebnis: **204.9** (195)
 Serien: 100.6 104.3
 Zähler: 15 5 0 0 0 0 0 0 0 0
 Innenzehner: 13
 weiteste: 365 (9), 305 (1), 301 (5)
 beste Teiler 18.2 (18.) 76.0 (20.) 84.1 (15.)
 Trefferlage 0.10 mm rechts, 0.27 mm hoch
 Streuwert 1.41, horizontal: 1.78, vertikal: 0.90

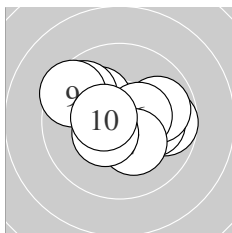
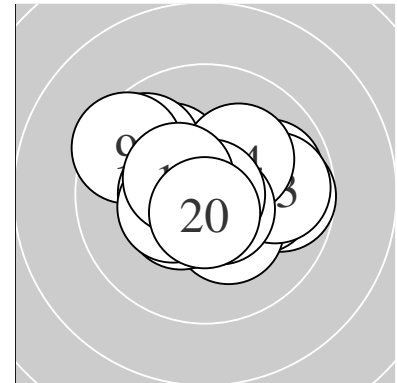

Serie 1:
 9.7 → 10.1 ↖ 10.1 → 9.9 → 9.7 ↖
 10.4 * 10.3 * 10.4 * 9.5 ↖ 10.5 *
 beste Teiler 108.6 (10.) 126.3 (8.) 135.1 (6.)
 Trefferlage 0.10 mm rechts, 0.40 mm hoch
 Streuwert 1.73, horizontal: 2.18, vertikal: 1.09

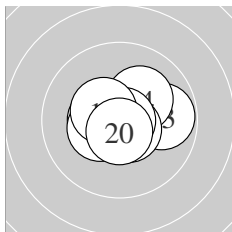

Serie 2:
 10.4 * 10.5 * 9.8 → 10.2 * 10.6 *
 10.4 * 10.4 * 10.9 * 10.5 * 10.6 *
 beste Teiler 18.2 (18.) 76.0 (20.) 84.1 (15.)
 Trefferlage 0.11 mm rechts, 0.14 mm hoch
 Streuwert 1.10, horizontal: 1.38, vertikal: 0.70

Unterschrift des Schützen

Ergebnis: **199.4** (191)
 Serien: 100.0 99.4
 Zähler: 12 7 1 0 0 0 0 0 0 0
 Innenzehner: 8
 weiteste: 636 (14), 461 (5), 401 (6)
 beste Teiler 54.0 (4.) 54.1 (10.) 81.5 (1.)
 Trefferlage 1.23 mm rechts, 0.24 mm hoch
 Streuwert 1.85, horizontal: 2.33, vertikal: 1.20

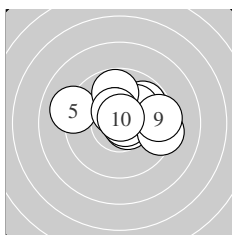
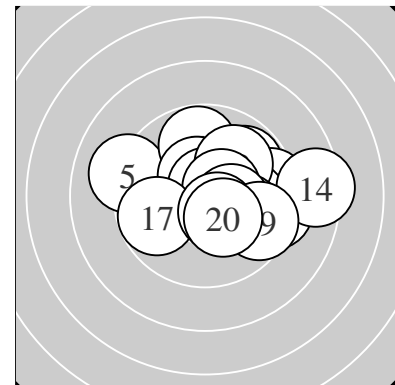

Serie 1:
 10.6 * 9.8 ↗ 10.1 ↗ 10.7 * 9.1 ↖
 9.3 → 9.8 ↑ 10.5 * 9.4 → 10.7 *
 beste Teiler 54.0 (4.) 54.1 (10.) 81.5 (1.)
 Trefferlage 0.74 mm rechts, 0.85 mm hoch
 Streuwert 1.86, horizontal: 2.40, vertikal: 1.09

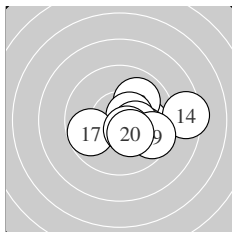

Serie 2:
 10.0 → 10.0 ↗ 10.5 * 8.4 → 10.0 ↘
 10.3 * 9.8 ↖ 10.5 * 9.6 ↘ 10.3 *
 beste Teiler 103.7 (13.) 114.0 (18.) 155.7 (16.)
 Trefferlage 1.72 mm rechts, 0.36 mm tief
 Streuwert 1.76, horizontal: 2.27, vertikal: 1.02

Unterschrift des Schützen

Ergebnis: **195.5** (186)
 Serien: 98.9 96.6
 Zähler: 8 10 2 0 0 0 0 0 0 0
 Innenzehner: 5
 weiteste: 697 (2), 554 (17), 481 (15)
 beste Teiler 7.8 (4.) 94.3 (6.) 135.0 (19.)
 Trefferlage 0.67 mm rechts, 0.04 mm tief
 Streuwert 2.37, horizontal: 3.06, vertikal: 1.37

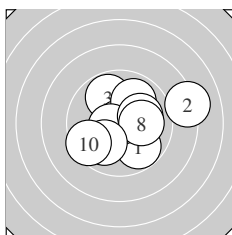
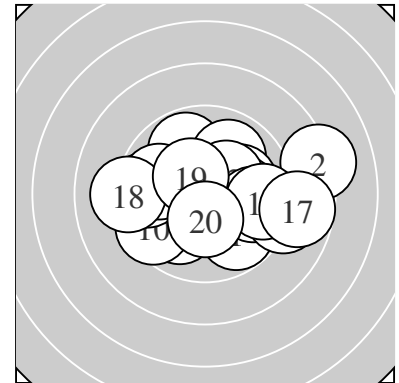

Serie 1:
 9.8 ↘ 8.2 → 9.8 ↖ 10.9 * 9.9 ↗
 10.6 * 10.1 → 10.1 → 10.0 ✓ 9.5 ↙
 beste Teiler 7.8 (4.) 94.3 (6.) 214.7 (7.)
 Trefferlage 0.74 mm rechts, 0.09 mm hoch
 Streuwert 2.30, horizontal: 2.74, vertikal: 1.76

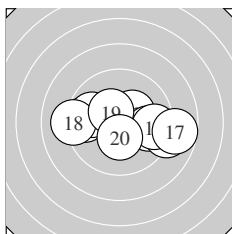

Serie 2:
 9.6 ← 10.3 * 9.8 → 9.8 ← 9.0 →
 9.6 → 8.7 → 9.1 ← 10.4 * 10.3 *
 beste Teiler 135.0 (19.) 151.0 (20.) 155.2 (12.)
 Trefferlage 0.60 mm rechts, 0.18 mm tief
 Streuwert 2.56, horizontal: 3.50, vertikal: 0.92

Unterschrift des Schützen

Ergebnis: **202.7** (193)
 Serien: 101.1 101.6
 Zähler: 13 7 0 0 0 0 0 0 0 0
 Innenzehner: 12
 weiteste: 391 (5), 369 (11), 354 (7)
 beste Teiler 55.1 (6.) 90.2 (2.) 94.1 (3.)
 Trefferlage 0.12 mm rechts, 0.25 mm hoch
 Streuwert 1.63, horizontal: 1.97, vertikal: 1.21

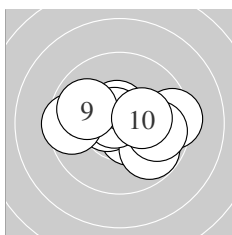
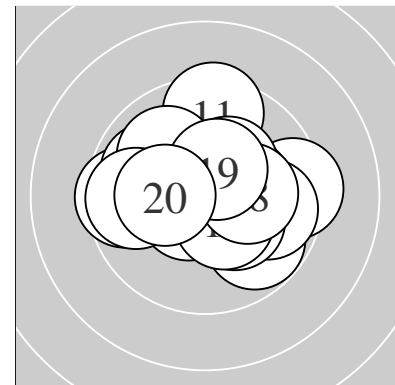

Serie 1:
 10.5 * 10.6 * 10.6 * 9.8 ↘ 9.4 →
 10.7 * 9.5 ← 9.8 → 9.9 ↖ 10.3 *
 beste Teiler 55.1 (6.) 90.2 (2.) 94.1 (3.)
 Trefferlage 0.38 mm rechts, 0.02 mm tief
 Streuwert 1.76, horizontal: 2.33, vertikal: 0.89

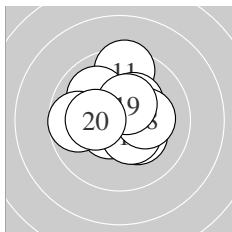

Serie 2:
 9.5 ↑ 10.0 ↖ 10.3 * 10.6 * 9.7 ←
 10.3 * 10.4 * 10.2 * 10.4 * 10.2 *
 beste Teiler 95.7 (14.) 129.3 (19.) 132.7 (17.)
 Trefferlage 0.12 mm links, 0.52 mm hoch
 Streuwert 1.54, horizontal: 1.61, vertikal: 1.47

Unterschrift des Schützen

Ergebnis: **206.1** (197)
 Serien: 102.2 103.9
 Zähler: 17 3 0 0 0 0 0 0 0 0
 Innenzehner: 16
 weiteste: 385 (8), 287 (1), 279 (12)
 beste Teiler 63.0 (19.) 64.3 (5.) 80.0 (14.)
 Trefferlage 0.25 mm links, 0.88 mm hoch
 Streuwert 1.14, horizontal: 1.18, vertikal: 1.10

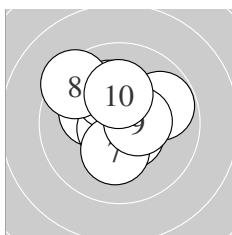
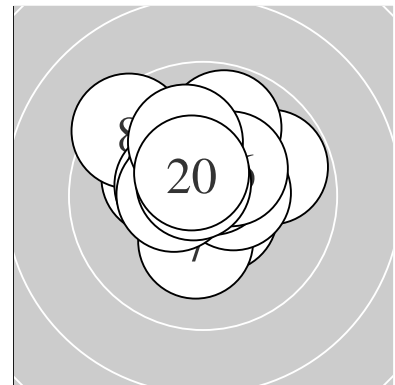

Serie 1:
 9.8 ↗ 10.2 * 10.4 * 10.6 * 10.7 *
 10.2 * 10.2 * 9.4 ↘ 10.5 * 10.2 *
 beste Teiler 64.3 (5.) 99.0 (4.) 119.6 (9.)
 Trefferlage 0.21 mm links, 0.67 mm hoch
 Streuwert 1.44, horizontal: 1.52, vertikal: 1.35

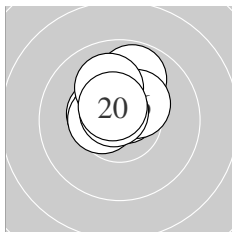

Serie 2:
 10.4 * 9.8 ↑ 10.3 * 10.6 * 10.5 *
 10.4 * 10.5 * 10.1 ↘ 10.7 * 10.6 *
 beste Teiler 63.0 (19.) 80.0 (14.) 100.6 (20.)
 Trefferlage 0.29 mm links, 1.08 mm hoch
 Streuwert 0.80, horizontal: 0.79, vertikal: 0.81

Unterschrift des Schützen

Ergebnis: **192.1** (182)
 Serien: 95.3 96.8
 Zähler: 6 10 4 0 0 0 0 0 0 0
 Innenzehner: 5
 weiteste: 625 (3), 619 (6), 524 (15)
 beste Teiler 152.9 (2.) 170.9 (9.) 176.9 (7.)
 Trefferlage 1.03 mm rechts, 0.62 mm hoch
 Streuwert 2.51, horizontal: 2.65, vertikal: 2.37

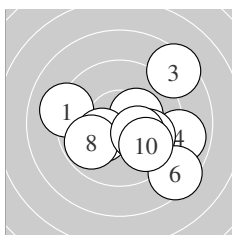
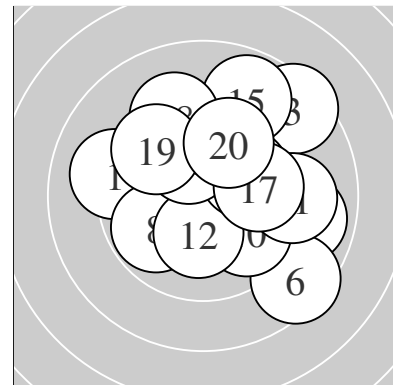

Serie 1:
 9.1 ← 10.3 * 8.5 ↗ 8.9 → 9.9 ↘
 8.5 ↘ 10.2 * 9.8 ↙ 10.3 * 9.8 ↘
 beste Teiler 152.9 (2.) 170.9 (9.) 176.9 (7.)
 Trefferlage 1.32 mm rechts, 0.53 mm tief
 Streuwert 2.73, horizontal: 3.16, vertikal: 2.22

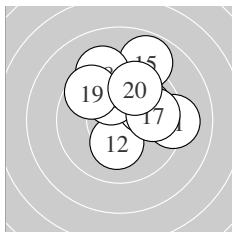

Serie 2:
 9.2 → 10.2 * 9.8 ↑ 10.0 ↗ 8.9 ↗
 10.2 * 9.8 → 9.3 ↓ 9.6 ↘ 9.8 ↗
 beste Teiler 186.4 (12.) 198.1 (16.) 235.3 (14.)
 Trefferlage 0.74 mm rechts, 1.79 mm hoch
 Streuwert 2.05, horizontal: 2.14, vertikal: 1.96

Unterschrift des Schützen

Ergebnis: **177.5** (169)
 Serien: 92.9 84.6
 Zähler: 4 7 6 2 0 0 1 0 0 0
 Innenzehner: 4
 weiteste: 1725 (17), 920 (18), 867 (19)
 beste Teiler 24.0 (15.) 43.0 (7.) 121.4 (8.)
 Trefferlage 1.20 mm rechts, 1.37 mm hoch
 Streuwert 4.44, horizontal: 5.78, vertikal: 2.45

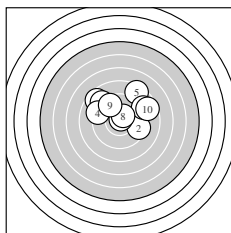
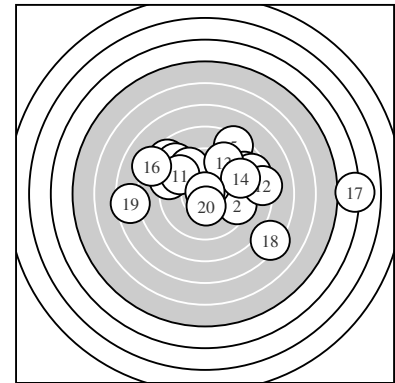

Serie 1:
 8.6 ↘ 9.4 → 9.0 ↘ 9.2 ↖ 8.4 ↗
 8.9 ↗ 10.8 * 10.5 * 9.5 ↘ 8.6 →

beste Teiler 43.0 (7.) 121.4 (8.) 357.7 (9.)
 Trefferlage 0.39 mm rechts, 2.29 mm hoch
 Streuwert 2.96, horizontal: 3.70, vertikal: 1.95

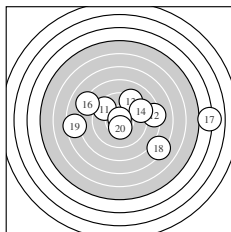

Serie 2:
 9.5 ↘ 8.3 → 9.2 ↗ 9.2 → 10.9 *
 8.2 ↖ 4.1 → 7.3 ↘ 7.5 ← 10.4 *

beste Teiler 24.0 (15.) 139.5 (20.) 363.8 (11.)
 Trefferlage 2.00 mm rechts, 0.44 mm hoch
 Streuwert 5.59, horizontal: 7.45, vertikal: 2.64

Unterschrift des Schützen

Ergebnis: **199.1** (190)
 Serien: 100.5 98.6
 Zähler: 10 10 0 0 0 0 0 0 0 0
 Innenzehner: 9
 weiteste: 462 (17), 455 (9), 396 (11)
 beste Teiler 21.8 (12.) 57.6 (6.) 120.2 (16.)
 Trefferlage 1.44 mm links, 0.25 mm hoch
 Streuwert 1.71, horizontal: 2.20, vertikal: 1.01

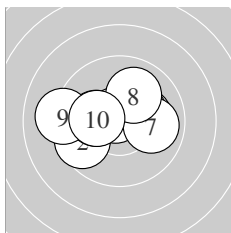
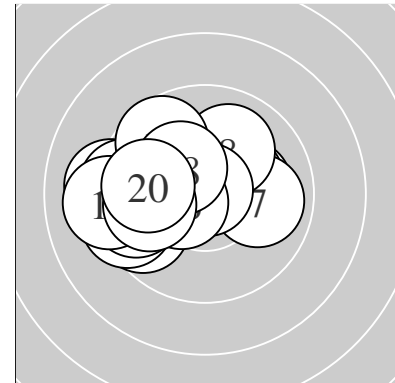

Serie 1:
 10.2 * 9.6 ← 10.3 * 10.3 * 10.2 *
 10.7 * 9.9 → 10.0 ↗ 9.1 ← 10.2 *
 beste Teiler 57.6 (6.) 155.7 (3.) 169.3 (4.)
 Trefferlage 0.36 mm links, 0.39 mm hoch
 Streuwert 1.79, horizontal: 2.35, vertikal: 0.95

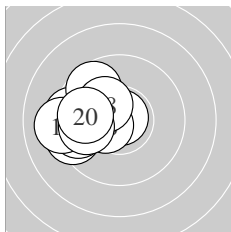

Serie 2:
 9.4 ← 10.9 * 9.6 ← 9.4 ← 9.7 ↖
 10.5 * 9.1 ← 10.3 * 9.9 ← 9.8 ←
 beste Teiler 21.8 (12.) 120.2 (16.) 171.8 (18.)
 Trefferlage 2.52 mm links, 0.12 mm hoch
 Streuwert 1.29, horizontal: 1.45, vertikal: 1.10

Unterschrift des Schützen

Ergebnis: **173.5** (164)
 Serien: 80.4 93.1
 Zähler: 0 11 4 3 2 0 0 0 0 0
 Innenzehner: 0
 weiteste: 1155 (9), 1005 (10), 939 (8)
 beste Teiler 254.0 (16.) 263.8 (4.) 302.8 (12.)
 Trefferlage 0.89 mm links, 1.40 mm hoch
 Streuwert 4.35, horizontal: 5.36, vertikal: 3.01

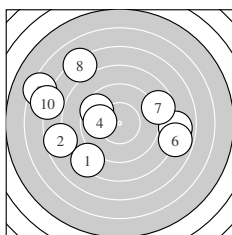
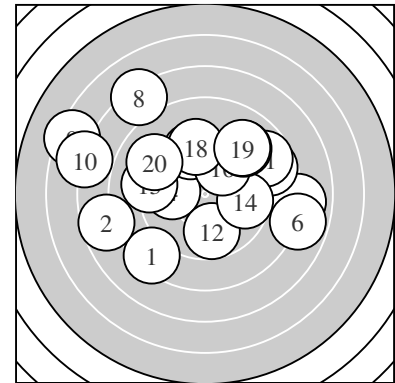

Serie 1:
 8.3 ↙ 7.7 ← 9.6 ↘ 9.9 ← 8.0 →
 7.8 → 8.7 → 7.2 ↘ 6.3 ↘ 6.9 ←
 beste Teiler 263.8 (4.) 347.2 (3.) 558.0 (7.)
 Trefferlage 2.34 mm links, 0.88 mm hoch
 Streuwert 5.46, horizontal: 6.79, vertikal: 3.69

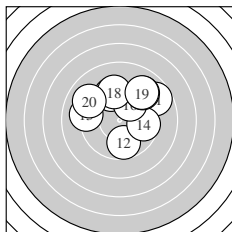

Serie 2:
 8.7 ↗ 9.7 ↓ 9.1 ← 9.7 → 9.5 ↖
 9.9 ↗ 9.0 ↗ 9.4 ↑ 9.1 ↗ 9.0 ↘
 beste Teiler 254.0 (16.) 302.8 (12.) 325.3 (14.)
 Trefferlage 0.55 mm rechts, 1.92 mm hoch
 Streuwert 2.72, horizontal: 3.15, vertikal: 2.22

Unterschrift des Schützen

Ergebnis: **202.0** (193)
 Serien: 100.6 101.4
 Zähler: 14 5 1 0 0 0 0 0 0 0
 Innenzehner: 12
 weiteste: 547 (6), 432 (3), 306 (1)
 beste Teiler 44.7 (9.) 62.0 (10.) 99.2 (5.)
 Trefferlage 0.62 mm links, 0.49 mm tief
 Streuwert 1.68, horizontal: 1.96, vertikal: 1.35

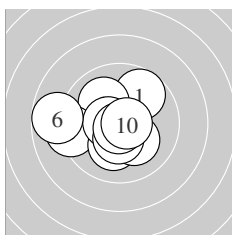
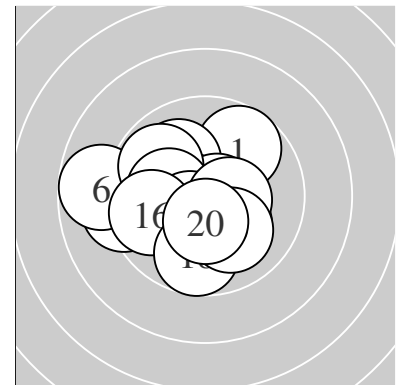

Serie 1:
 9.7 ↗ 10.0 ↘ 9.2 ← 10.2 * 10.6 *
 8.8 ← 10.2 * 10.4 * 10.8 * 10.7 *
 beste Teiler 44.7 (9.) 62.0 (10.) 99.2 (5.)
 Trefferlage 0.91 mm links, 0.10 mm tief
 Streuwert 1.91, horizontal: 2.31, vertikal: 1.41

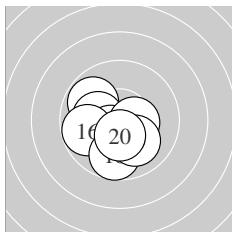

Serie 2:
 9.8 ↘ 10.2 * 10.2 * 10.3 * 10.5 *
 9.8 ← 10.4 * 9.7 ↓ 10.1 ↘ 10.4 *
 beste Teiler 122.7 (15.) 129.7 (17.) 134.0 (20.)
 Trefferlage 0.32 mm links, 0.88 mm tief
 Streuwert 1.43, horizontal: 1.60, vertikal: 1.23

Unterschrift des Schützen

Ergebnis: **184.2** (177)
 Serien: 90.9 93.3
 Zähler: 6 6 7 1 0 0 0 0 0 0
 Innenzehner: 6
 weiteste: 897 (12), 740 (1), 616 (6)
 beste Teiler 66.6 (20.) 133.4 (3.) 166.6 (13.)
 Trefferlage 1.60 mm rechts, 0.87 mm tief
 Streuwert 3.29, horizontal: 4.35, vertikal: 1.64

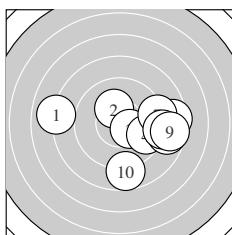
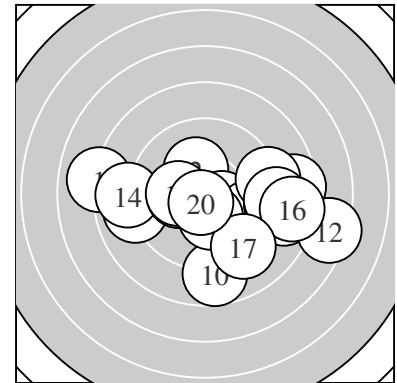

Serie 1:
 8.0 ← 10.2 * 10.4 * 9.6 → 8.7 →
 8.5 → 9.2 → 9.0 → 8.6 → 8.7 ↓
 beste Teiler 133.4 (3.) 179.7 (2.) 332.3 (4.)
 Trefferlage 2.36 mm rechts, 0.63 mm tief
 Streuwert 3.26, horizontal: 4.14, vertikal: 2.03

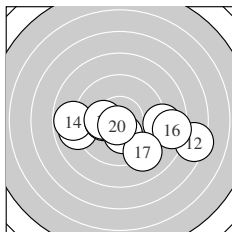

Serie 2:
 9.0 ← 7.4 → 10.3 * 8.8 ← 9.0 →
 8.5 → 9.2 ↘ 10.2 * 10.2 * 10.7 *
 beste Teiler 66.6 (20.) 166.6 (13.) 181.3 (18.)
 Trefferlage 0.84 mm rechts, 1.11 mm tief
 Streuwert 3.39, horizontal: 4.64, vertikal: 1.19

Unterschrift des Schützen

Ergebnis: **191.9** (183)
 Serien: 96.2 95.7
 Zähler: 7 10 2 1 0 0 0 0 0 0
 Innenzehner: 5
 weiteste: 849 (10), 645 (8), 628 (17)
 beste Teiler 123.0 (2.) 134.6 (7.) 137.3 (16.)
 Trefferlage 0.63 mm links, 0.27 mm tief
 Streuwert 2.77, horizontal: 3.44, vertikal: 1.86

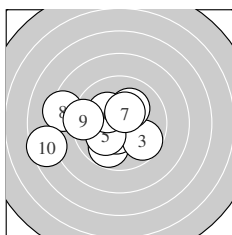
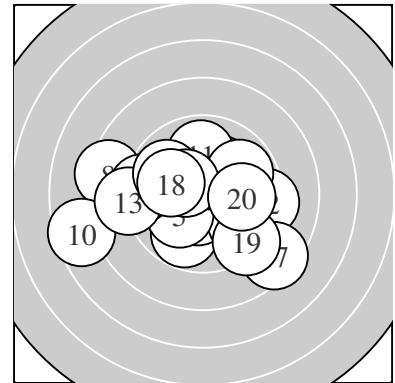

Serie 1:
 9.8 ↙ 10.5 * 9.7 ↘ 10.2 * 10.1 ↙
 10.2 * 10.4 * 8.4 ← 9.3 ← 7.6 ←
 beste Teiler 123.0 (2.) 134.6 (7.) 180.7 (6.)
 Trefferlage 1.86 mm links, 0.38 mm tief
 Streuwert 2.66, horizontal: 3.34, vertikal: 1.71

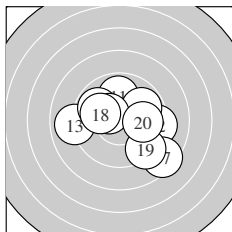

Serie 2:
 9.9 ↑ 9.3 → 9.0 ← 9.8 ↗ 9.8 ↖
 10.4 * 8.4 ↘ 10.0 ← 9.2 ↘ 9.9 →
 beste Teiler 137.3 (16.) 226.4 (18.) 258.7 (20.)
 Trefferlage 0.59 mm rechts, 0.16 mm tief
 Streuwert 2.72, horizontal: 3.23, vertikal: 2.09

Unterschrift des Schützen

Ergebnis: **205.3** (195)
 Serien: 104.4 100.9
 Zähler: 15 5 0 0 0 0 0 0 0 0
 Innenzehner: 13
 weiteste: 371 (11), 309 (15), 276 (13)
 beste Teiler 37.3 (18.) 68.4 (3.) 79.3 (2.)
 Trefferlage 0.22 mm links, 0.12 mm hoch
 Streuwert 1.40, horizontal: 1.83, vertikal: 0.77

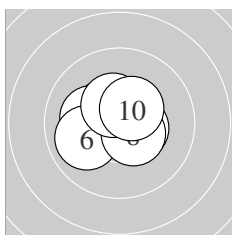
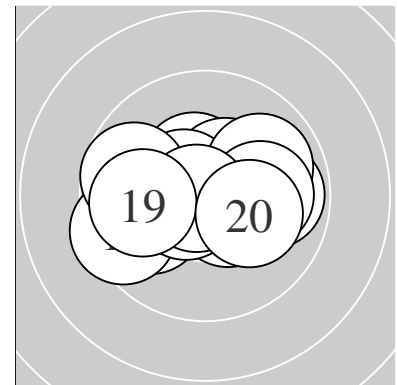

Serie 1:
 10.6 * 10.6 * 10.7 * 10.5 * 10.2 *
 10.0 ← 10.5 * 10.5 * 10.4 * 10.4 *
 beste Teiler 68.4 (3.) 79.3 (2.) 94.0 (1.)
 Trefferlage 0.26 mm links, 0.27 mm hoch
 Streuwert 1.02, horizontal: 1.21, vertikal: 0.78

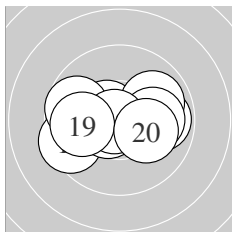

Serie 2:
 9.5 ← 10.5 * 9.8 → 9.9 ↗ 9.7 ←
 10.6 * 10.0 → 10.8 * 9.9 ← 10.2 *
 beste Teiler 37.3 (18.) 90.8 (16.) 104.1 (12.)
 Trefferlage 0.18 mm links, 0.03 mm tief
 Streuwert 1.76, horizontal: 2.36, vertikal: 0.77

Unterschrift des Schützen

Ergebnis: **185.1** (176)
 Serien: 94.4 90.7
 Zähler: 6 6 6 2 0 0 0 0 0 0
 Innenzehner: 6
 weiteste: 788 (14), 756 (1), 603 (19)
 beste Teiler 107.5 (3.) 144.3 (5.) 165.6 (7.)
 Trefferlage 1.63 mm rechts, 1.55 mm tief
 Streuwert 2.98, horizontal: 4.04, vertikal: 1.21

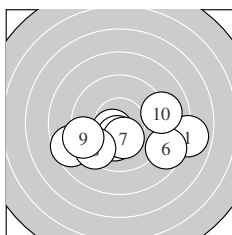
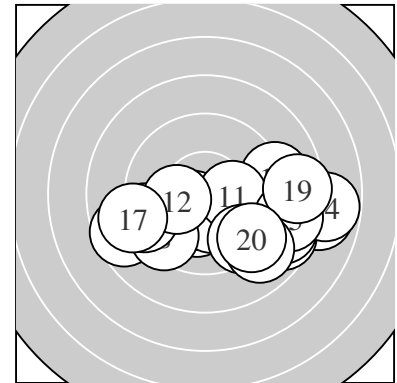

Serie 1:
 7.9 → 10.2 * 10.5 * 8.6 ← 10.4 *
 8.7 ↘ 10.3 * 9.4 ↙ 9.3 ← 9.1 →
 beste Teiler 107.5 (3.) 144.3 (5.) 165.6 (7.)
 Trefferlage 0.39 mm rechts, 1.54 mm tief
 Streuwert 3.01, horizontal: 4.11, vertikal: 1.14

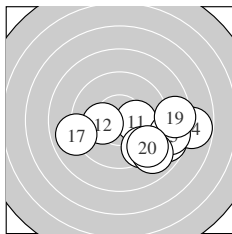

Serie 2:
 10.2 * 10.2 * 8.7 ↘ 7.8 → 8.7 →
 9.4 ↘ 9.0 ← 8.9 ↘ 8.5 → 9.3 ↘
 beste Teiler 178.2 (11.) 188.4 (12.) 381.5 (16.)
 Trefferlage 2.86 mm rechts, 1.57 mm tief
 Streuwert 2.83, horizontal: 3.77, vertikal: 1.33

Unterschrift des Schützen

Ergebnis: **209.7** (199)
 Serien: 104.1 105.6
 Zähler: 19 1 0 0 0 0 0 0 0 0
 Innenzehner: 17
 weiteste: 283 (9), 214 (10), 212 (1)
 beste Teiler 10.0 (19.) 44.2 (2.) 65.2 (4.)
 Trefferlage 0.06 mm rechts, 0.57 mm tief
 Streuwert 0.88, horizontal: 0.88, vertikal: 0.87

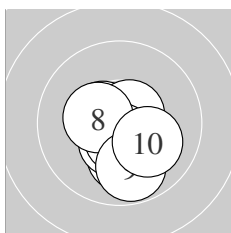
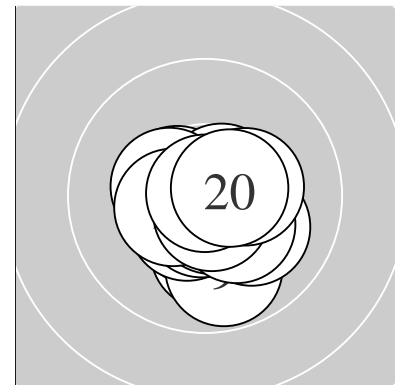

Serie 1:
 10.1 ↓ 10.8 * 10.5 * 10.7 * 10.5 *
 10.6 * 10.6 * 10.4 * 9.8 ↓ 10.1 ↘
 beste Teiler 44.2 (2.) 65.2 (4.) 81.6 (6.)
 Trefferlage 0.05 mm links, 0.68 mm tief
 Streuwert 1.04, horizontal: 0.93, vertikal: 1.14

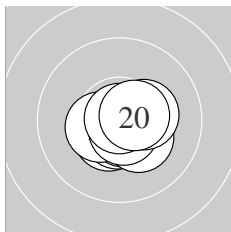

Serie 2:
 10.7 * 10.5 * 10.6 * 10.6 * 10.4 *
 10.3 * 10.7 * 10.3 * 10.9 * 10.6 *
 beste Teiler 10.0 (19.) 65.3 (11.) 68.1 (17.)
 Trefferlage 0.18 mm rechts, 0.45 mm tief
 Streuwert 0.71, horizontal: 0.86, vertikal: 0.53

Unterschrift des Schützen

Ergebnis: **180.7** (173)
 Serien: 88.9 91.8
 Zähler: 6 7 5 0 1 0 1 0 0 0
 Innenzehner: 4
 weiteste: 1579 (1), 1094 (12), 727 (17)
 beste Teiler 83.0 (13.) 121.7 (7.) 193.0 (15.)
 Trefferlage 1.57 mm rechts, 0.24 mm tief
 Streuwert 4.13, horizontal: 5.56, vertikal: 1.78

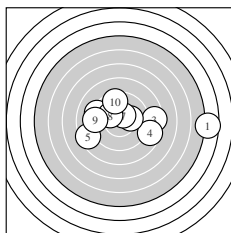
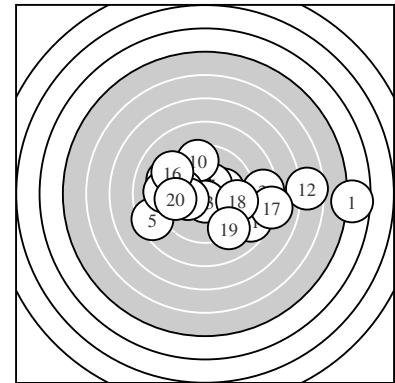

Serie 1:
 4.6 → 9.2 ← 8.5 → 8.6 ↘ 8.5 ←
 10.1 → 10.5 * 10.2 * 9.2 ← 9.5 ↑
 beste Teiler 121.7 (7.) 198.6 (8.) 202.0 (6.)
 Trefferlage 1.35 mm rechts, 0.25 mm hoch
 Streuwert 4.73, horizontal: 6.44, vertikal: 1.80

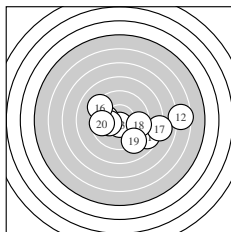

Serie 2:
 8.7 ↘ 6.6 → 10.6 * 10.0 ← 10.2 *
 9.3 ↙ 8.0 → 9.5 → 9.2 ↘ 9.7 ←
 beste Teiler 83.0 (13.) 193.0 (15.) 249.4 (14.)
 Trefferlage 1.79 mm rechts, 0.74 mm tief
 Streuwert 3.64, horizontal: 4.86, vertikal: 1.70

Unterschrift des Schützen

Ergebnis: **201.2** (191)
 Serien: 99.8 101.4
 Zähler: 11 9 0 0 0 0 0 0 0 0
 Innenzehner: 7
 weiteste: 349 (7), 345 (10), 326 (4)
 beste Teiler 37.3 (19.) 50.6 (12.) 116.5 (5.)
 Trefferlage 0.37 mm links, 0.16 mm hoch
 Streuwert 1.71, horizontal: 2.19, vertikal: 1.00

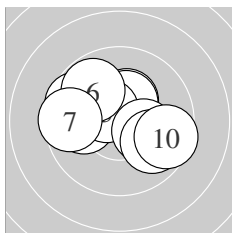
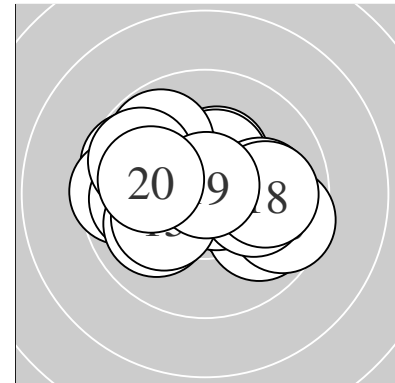

Serie 1:
 10.3 * 9.9 ← 10.4 * 9.6 ↖ 10.5 *
 9.8 ↘ 9.6 ← 10.2 * 9.9 ↘ 9.6 →
 beste Teiler 116.5 (5.) 139.4 (3.) 153.0 (1.)
 Trefferlage 0.36 mm links, 0.37 mm hoch
 Streuwert 1.87, horizontal: 2.35, vertikal: 1.20

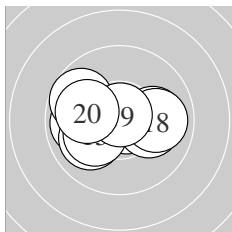

Serie 2:
 9.9 ← 10.8 * 9.7 ↖ 10.0 ↙ 10.2 *
 10.0 → 10.1 → 9.9 → 10.8 * 10.0 ←
 beste Teiler 37.3 (19.) 50.6 (12.) 199.3 (15.)
 Trefferlage 0.39 mm links, 0.05 mm tief
 Streuwert 1.61, horizontal: 2.15, vertikal: 0.76

Unterschrift des Schützen

Ergebnis: **189.6** (180)
 Serien: 94.0 95.6
 Zähler: 8 6 4 2 0 0 0 0 0 0
 Innenzehner: 5
 weiteste: 799 (15), 792 (4), 690 (6)
 beste Teiler 30.5 (9.) 66.9 (11.) 98.0 (5.)
 Trefferlage 0.62 mm rechts, 0.02 mm hoch
 Streuwert 3.16, horizontal: 4.25, vertikal: 1.41

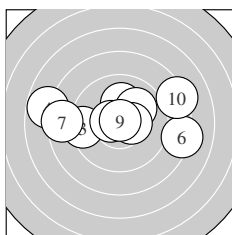
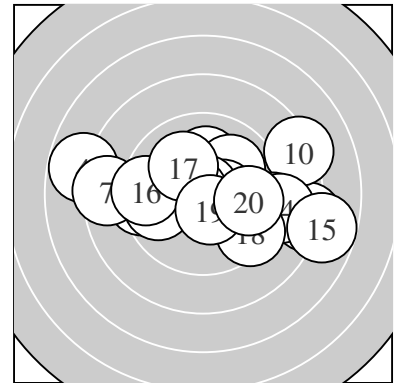

Serie 1:
 10.1 ↑ 10.0 ↗ 9.4 ← 7.8 ← 10.6 *
 8.2 → 8.5 ← 10.4 * 10.8 * 8.2 →
 beste Teiler 30.5 (9.) 98.0 (5.) 127.0 (8.)
 Trefferlage 0.26 mm links, 0.69 mm hoch
 Streuwert 3.48, horizontal: 4.75, vertikal: 1.31

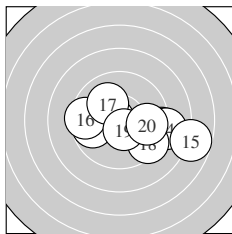

Serie 2:
 10.7 * 9.1 → 9.8 ← 8.9 → 7.8 →
 9.5 ← 10.1 ↘ 9.4 ↘ 10.5 * 9.8 →
 beste Teiler 66.9 (11.) 112.8 (19.) 220.0 (17.)
 Trefferlage 1.51 mm rechts, 0.65 mm tief
 Streuwert 2.76, horizontal: 3.71, vertikal: 1.21

Unterschrift des Schützen

Ergebnis: **174.0** (164)
 Serien: 82.6 91.4
 Zähler: 5 7 3 3 1 0 0 0 0 0
 Innenzehner: 4
 weiteste: 2664 (6), 1189 (19), 866 (3)
 beste Teiler 108.0 (20.) 115.0 (15.) 124.2 (9.)
 Trefferlage 1.62 mm rechts, 0.81 mm hoch
 Streuwert 5.59, horizontal: 7.74, vertikal: 1.59

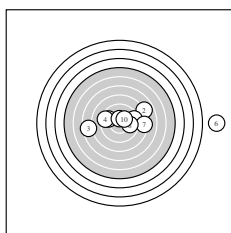
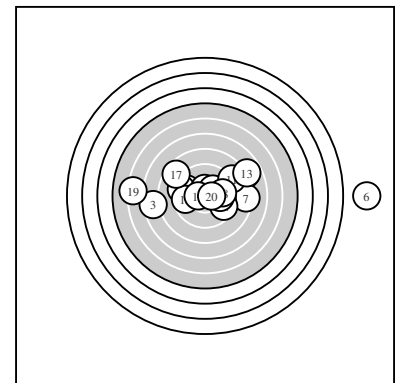

Serie 1:
 9.7 ↖ 7.9 ↗ 7.5 ← 9.3 ↖ 9.3 →
 0.0 → 8.3 → 9.8 → 10.5 * 10.3 *
 beste Teiler 124.2 (9.) 170.6 (10.) 285.6 (8.)
 Trefferlage 3.26 mm rechts, 0.72 mm hoch
 Streuwert 6.81, horizontal: 9.53, vertikal: 1.36

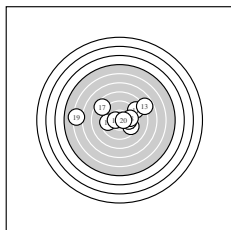

Serie 2:
 8.9 ↗ 9.6 ← 7.8 ↗ 9.5 ↘ 10.5 *
 10.0 → 8.6 ↖ 9.8 → 6.2 ← 10.5 *
 beste Teiler 108.0 (20.) 115.0 (15.) 249.2 (16.)
 Trefferlage 0.01 mm links, 0.90 mm hoch
 Streuwert 4.07, horizontal: 5.45, vertikal: 1.86

Unterschrift des Schützen

Ergebnis: **203.0** (191)
 Serien: 103.7 99.3
 Zähler: 13 5 2 0 0 0 0 0 0 0
 Innenzehner: 12
 weiteste: 561 (16), 540 (17), 284 (12)
 beste Teiler 6.0 (7.) 21.2 (13.) 81.8 (4.)
 Trefferlage 0.48 mm links, 1.12 mm tief
 Streuwert 1.54, horizontal: 1.62, vertikal: 1.46

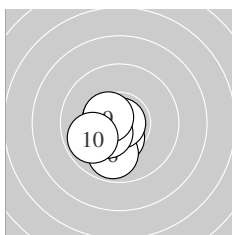
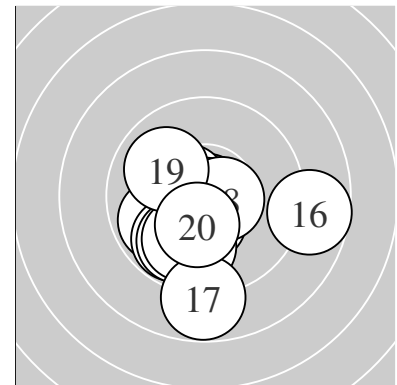

Serie 1:
 10.2 * 10.5 * 10.4 * 10.6 * 10.4 *
 9.9 ↓ 10.9 * 10.4 * 10.5 * 9.9 ←
 beste Teiler 6.0 (7.) 81.8 (4.) 111.9 (2.)
 Trefferlage 0.91 mm links, 0.76 mm tief
 Streuwert 0.83, horizontal: 0.68, vertikal: 0.95

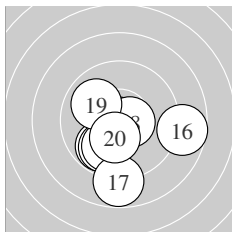

Serie 2:
 10.5 * 9.8 ↙ 10.9 * 9.8 ↙ 9.9 ↙
 8.7 → 8.8 ↓ 10.6 * 10.0 ↘ 10.3 *
 beste Teiler 21.2 (13.) 91.7 (18.) 119.1 (11.)
 Trefferlage 0.06 mm links, 1.49 mm tief
 Streuwert 2.00, horizontal: 2.16, vertikal: 1.81

Unterschrift des Schützen