

Ergebnis: **411.0** (389)
 Serien: 101.4 104.9 102.0 102.7
 Zähler: 30 9 1 0 0 0 0 0 0 0
 Innenzehner: 26
 Weitestе: 577 (9.), 447 (30.), 413 (10.)
 beste Teiler: 14.0 (35.), 21.0 (22.), 24.4 (12.)
 Trefferlage: 0.49 mm links, 0.25 mm hoch
 Streuwert: 1.47, horizontal: 1.92, vertikal: 0.80

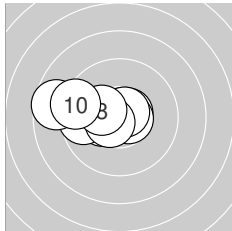
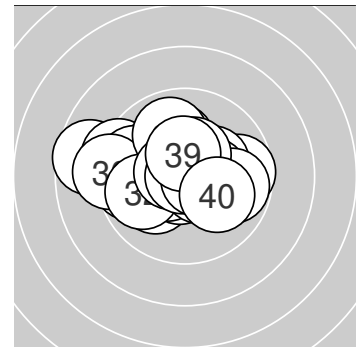

Serie 1: 101.4 (96)

10.7* ↗	10.3* ←	10.6* →	9.7 ←	10.6* →
10.7* ↗	10.6* ↙	10.3* ↖	8.6 ←	9.3 ←

beste Teiler: 60.8 (1.), 63.6 (6.), 79.0 (5.)
 Trefferlage: 1.44 mm links, 0.30 mm hoch
 Streuwert: 1.63, horizontal: 2.22, vertikal: 0.58

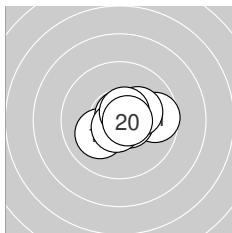

Serie 2: 104.9 (99)

9.7 →	10.9* ↗	10.6* →	10.6* →	10.1 ↙
10.8* ↑	10.7* ↘	10.2* →	10.6* ↗	10.7* →

beste Teiler: 24.4 (12.), 43.0 (16.), 69.7 (17.)
 Trefferlage: 0.58 mm rechts, 0.05 mm hoch
 Streuwert: 1.00, horizontal: 1.28, vertikal: 0.61

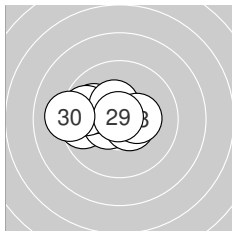

Serie 3: 102.0 (97)

9.6 ←	10.9* ↘	10.5* ←	10.0 ↖	10.5* ↘
9.7 ←	10.4* ↑	10.3* →	10.9* ↖	9.2 ←

beste Teiler: 21.0 (22.), 25.0 (29.), 106.2 (25.)
 Trefferlage: 1.21 mm links, 0.19 mm hoch
 Streuwert: 1.46, horizontal: 1.96, vertikal: 0.63

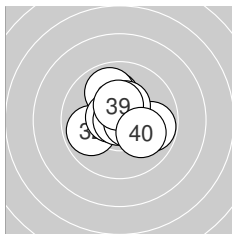

Serie 4: 102.7 (97)

10.1 ↑	9.9 ←	9.9 ↖	10.6* ↖	10.9* ←
9.8 →	10.6* →	10.4* ↗	10.4* ↑	10.1 ↘

beste Teiler: 14.0 (35.), 81.5 (37.), 84.7 (34.)
 Trefferlage: 0.10 mm rechts, 0.46 mm hoch
 Streuwert: 1.39, horizontal: 1.51, vertikal: 1.26



Ergebnis: 412.8 (392)
Serien: 103.9 104.1 102.1 102.7
Zähler: 33 6 1 0 0 0 0 0 0 0
Innenzehner: 30
Weiteste: 592 (37.), 345 (19.), 334 (25.)
beste Teiler: 25.0 (8.), 35.4 (30.), 40.3 (34.)
Trefferlage: 0.44 mm links, 0.07 mm tief
Streuwert: 1.35, horizontal: 1.42, vertikal: 1.27

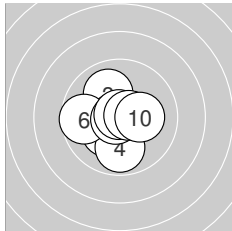
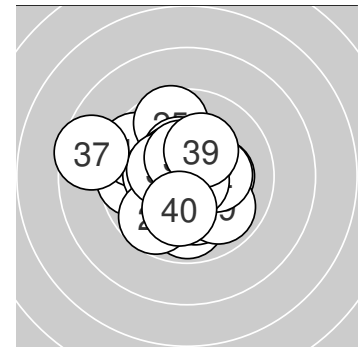

Serie 1: 103.9 (98)

10.2* ↙	10.8* ↖	10.0 ↘	9.9 ↓	10.8* ←
9.7 ←	10.8* ↙	10.9* ↑	10.6* →	10.2* →

beste Teiler: 25.0 (8.), 41.5 (7.), 42.4 (2.)
Trefferlage: 0.40 mm links, 0.17 mm tief
Streuwert: 1.27, horizontal: 1.32, vertikal: 1.22

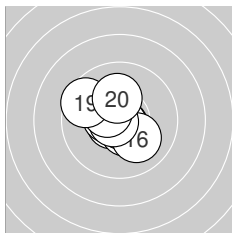

Serie 2: 104.1 (99)

10.7* ↘	10.6* ↙	10.5* ↘	10.8* ↘	10.5* ←
10.1 ↘	10.7* ↙	10.4* ↖	9.6 ↖	10.2* ↑

beste Teiler: 47.8 (14.), 53.8 (11.), 56.0 (17.)
Trefferlage: 0.41 mm links, 0.05 mm hoch
Streuwert: 1.17, horizontal: 1.23, vertikal: 1.10

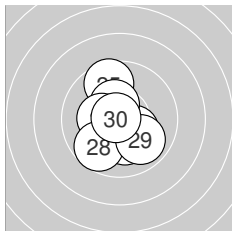

Serie 3: 102.1 (97)

10.3* ↘	10.5* ↙	10.2* ↓	10.4* ↙	9.6 ↑
10.4* ↑	10.3* ←	9.7 ↙	9.9 ↘	10.8* ←

beste Teiler: 35.4 (30.), 102.0 (22.), 128.5 (24.)
Trefferlage: 0.28 mm links, 0.43 mm tief
Streuwert: 1.47, horizontal: 1.19, vertikal: 1.70

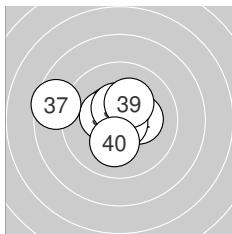

Serie 4: 102.7 (98)

10.7* ↓	10.3* →	10.5* ↖	10.8* ↘	10.6* ←
10.4* ←	8.6 ↖	10.5* ↑	10.2* ↑	10.1 ↓

beste Teiler: 40.3 (34.), 70.1 (31.), 88.2 (35.)
Trefferlage: 0.67 mm links, 0.23 mm hoch
Streuwert: 1.60, horizontal: 2.00, vertikal: 1.07



Ergebnis: **393.8** (376)
 Serien: 97.0 98.9 98.2 99.7
 Zähler: 20 16 4 0 0 0 0 0 0 0
 Innenzehner: 16
 Weitester: 674 (2.), 608 (35.), 571 (5.)
 beste Teiler: 20.0 (4.), 29.0 (37.), 36.7 (39.)
 Trefferlage: 0.70 mm links, 0.95 mm tief
 Streuwert: 2.15, horizontal: 2.56, vertikal: 1.65

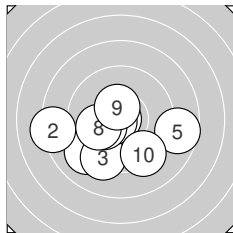
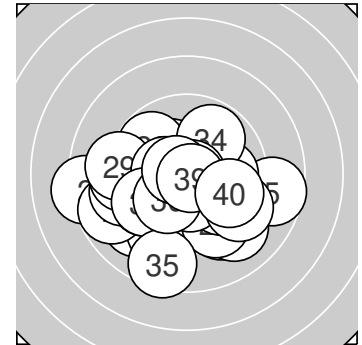

Serie 1: 97.0 (93)

9.1 ↙	8.3 ←	9.3 ↘	10.9* ←	8.7 →
10.7* ←	10.2* ←	10.0 ←	10.5* ↗	9.3 ↘

beste Teiler: 20.0 (4.), 67.0 (6.), 123.7 (9.)
 Trefferlage: 0.88 mm links, 1.30 mm tief
 Streuwert: 2.56, horizontal: 3.25, vertikal: 1.62

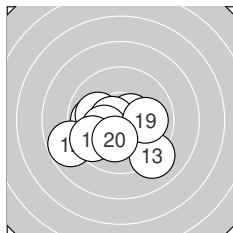

Serie 2: 98.9 (95)

9.9 ←	8.8 ↙	9.1 ↘	10.5* →	10.0 ←
10.6* ←	10.2* ←	9.6 ↙	10.0 →	10.2* ↘

beste Teiler: 83.4 (16.), 104.4 (14.), 180.2 (17.)
 Trefferlage: 0.91 mm links, 0.92 mm tief
 Streuwert: 2.01, horizontal: 2.49, vertikal: 1.36

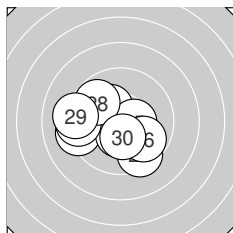

Serie 3: 98.2 (94)

10.3* ↘	9.5 ↘	9.2 ←	10.4* ↓	10.4* →
9.8 ↘	9.3 ←	9.8 ↘	9.2 ←	10.3* ↓

beste Teiler: 132.2 (25.), 134.9 (24.), 155.4 (30.)
 Trefferlage: 1.06 mm links, 0.55 mm tief
 Streuwert: 2.13, horizontal: 2.58, vertikal: 1.55

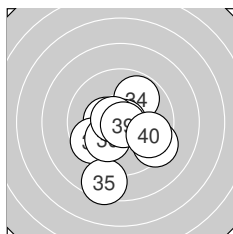

Serie 4: 99.7 (94)

10.4* ←	9.3 ↘	9.6 ↙	9.8 ↗	8.5 ↓
10.1 ↙	10.8* →	10.7* ←	10.8* ↘	9.7 ↘

beste Teiler: 29.0 (37.), 36.7 (39.), 75.9 (38.)
 Trefferlage: 0.06 mm rechts, 1.02 mm tief
 Streuwert: 2.08, horizontal: 2.00, vertikal: 2.16



Ergebnis: **414.9** (395)
 Serien: 103.5 103.1 103.5 104.8
 Zähler: 36 3 1 0 0 0 0 0 0 0
 Innenzehner: 33
 Weitester: 557 (18.), 361 (24.), 278 (5.)
 beste Teiler: 13.0 (31.), 13.8 (7.), 20.0 (27.)
 Trefferlage: 0.22 mm rechts, 0.06 mm hoch
 Streuwert: 1.25, horizontal: 1.52, vertikal: 0.92

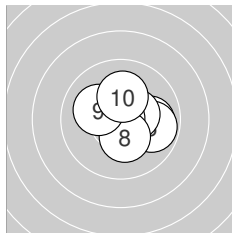
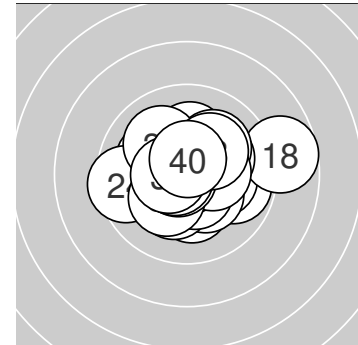

Serie 1: 103.5 (98)

9.9 →	10.9* ↖	10.4* ↖	10.6* →	9.8 →
10.4* →	10.9* ↖	10.3* ↓	10.1 ↖	10.2* ↑

beste Teiler: 13.8 (7.), 25.8 (2.), 94.5 (4.)
 Trefferlage: 0.45 mm rechts, 0.16 mm hoch
 Streuwert: 1.23, horizontal: 1.45, vertikal: 0.96

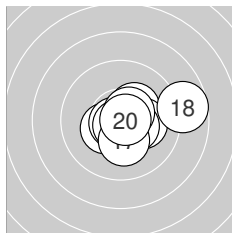

Serie 2: 103.1 (98)

10.3* ↗	10.2* →	10.4* ↙	10.7* ↙	10.8* ↓
10.4* →	10.2* ↓	8.7 →	10.6* ↗	10.8* →

beste Teiler: 42.1 (20.), 47.4 (15.), 58.6 (14.)
 Trefferlage: 0.90 mm rechts, 0.10 mm tief
 Streuwert: 1.44, horizontal: 1.84, vertikal: 0.88

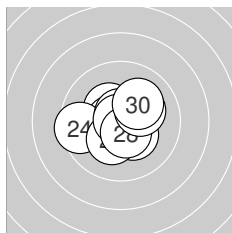

Serie 3: 103.5 (99)

10.3* ↓	10.4* ↖	10.6* ←	9.5 ←	10.3* ↓
10.7* ↑	10.9* ↖	10.5* ↓	10.2* →	10.1 ↗

beste Teiler: 20.0 (27.), 61.2 (26.), 79.0 (23.)
 Trefferlage: 0.15 mm links, 0.00 mm
 Streuwert: 1.32, horizontal: 1.54, vertikal: 1.05

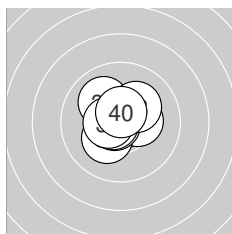

Serie 4: 104.8 (100)

10.9* ↓	10.6* ↙	10.0 ↖	10.4* →	10.2* ↙
10.7* ↙	10.7* ↙	10.2* ↗	10.5* ←	10.6* ↑

beste Teiler: 13.0 (31.), 56.3 (36.), 70.0 (37.)
 Trefferlage: 0.29 mm links, 0.18 mm hoch
 Streuwert: 0.97, horizontal: 1.02, vertikal: 0.90



Ergebnis: **420.5** (399)
 Serien: 105.6 103.9 105.5 105.5
 Zähler: 39 1 0 0 0 0 0 0 0 0
 Innenzehner: 36
 Weitestе: 267 (11.), 237 (35.), 224 (15.)
 beste Teiler: 11.4 (40.), 26.1 (9.), 28.8 (31.)
 Trefferlage: 0.15 mm links, 0.36 mm tief
 Streuwert: 0.87, horizontal: 0.91, vertikal: 0.83

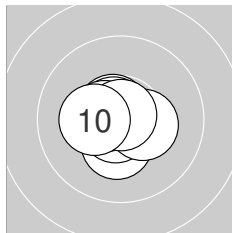
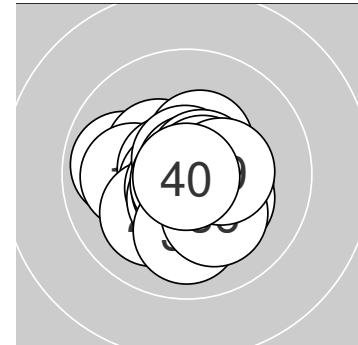

Serie 1: 105.6 (100)

10.6* ←	10.6* ←	10.3* ↓	10.7* ↗	10.7* ↘
10.4* →	10.7* ↘	10.5* ←	10.8* ↑	10.3* ←

beste Teiler: 26.1 (9.), 58.8 (4.), 61.5 (7.)
 Trefferlage: 0.43 mm links, 0.04 mm tief
 Streuwert: 0.71, horizontal: 0.79, vertikal: 0.62

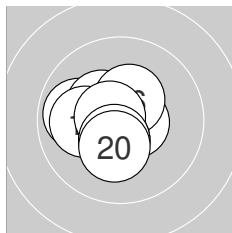

Serie 2: 103.9 (99)

9.9 ←	10.7* →	10.6* →	10.4* ↘	10.1 ←
10.4* ↗	10.4* ↓	10.7* ←	10.4* ↓	10.3* ↓

beste Teiler: 66.1 (12.), 71.4 (18.), 84.1 (13.)
 Trefferlage: 0.59 mm links, 0.15 mm tief
 Streuwert: 1.07, horizontal: 1.17, vertikal: 0.96

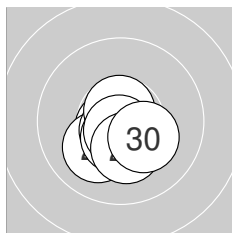

Serie 3: 105.5 (100)

10.7* ↖	10.1 ↗	10.7* ↗	10.8* ↘	10.7* ↓
10.7* ↑	10.5* ↓	10.7* ↓	10.3* ↓	10.3* ↘

beste Teiler: 48.1 (24.), 60.6 (28.), 64.4 (26.)
 Trefferlage: 0.06 mm links, 0.72 mm tief
 Streuwert: 0.71, horizontal: 0.74, vertikal: 0.67

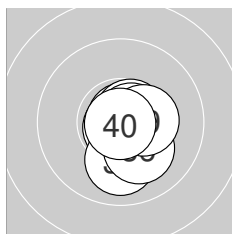

Serie 4: 105.5 (100)

10.8* ↗	10.6* ↘	10.8* ↓	10.5* ↓	10.0 ↓
10.2* ↘	10.6* ↗	10.7* →	10.4* →	10.9* ↓

beste Teiler: 11.4 (40.), 28.8 (31.), 37.6 (33.)
 Trefferlage: 0.47 mm rechts, 0.53 mm tief
 Streuwert: 0.75, horizontal: 0.52, vertikal: 0.93



Ergebnis: 416.2 (396)
Serien: 104.8 103.5 103.3 104.6
Zähler: 36 4 0 0 0 0 0 0 0 0 0
Innenzehner: 34
Weiteste: 467 (25.), 360 (18.), 273 (15.)
beste Teiler: 32.6 (31.), 44.6 (1.), 45.6 (5.)
Trefferlage: 0.12 mm links, 0.01 mm tief
Streuwert: 1.16, horizontal: 1.29, vertikal: 1.01

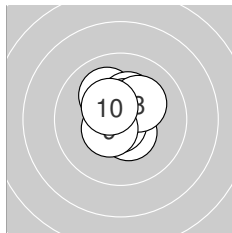
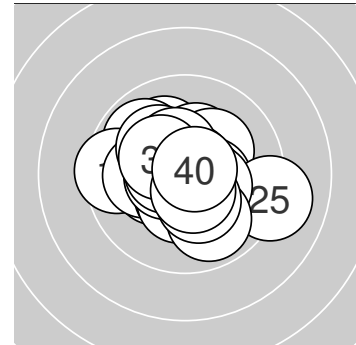

Serie 1: 104.8 (100)

10.8* ↘	10.1 ↖	10.5* ↘	10.3* ↗	10.8* ↙
10.7* ↖	10.5* ↗	10.2* ↗	10.5* ↖	10.4* ↖

beste Teiler: 44.6 (1.), 45.6 (5.), 64.6 (6.)
Trefferlage: 0.01 mm links, 0.45 mm hoch
Streuwert: 0.92, horizontal: 0.80, vertikal: 1.02

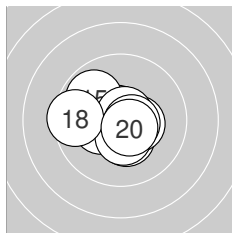

Serie 2: 103.5 (98)

10.3* ←	10.4* ↓	10.4* →	10.7* ↖	9.9 ↖
10.7* ↗	10.4* ↓	9.5 ←	10.6* →	10.6* ↘

beste Teiler: 52.8 (16.), 54.0 (14.), 90.9 (19.)
Trefferlage: 0.35 mm links, 0.14 mm tief
Streuwert: 1.28, horizontal: 1.56, vertikal: 0.93

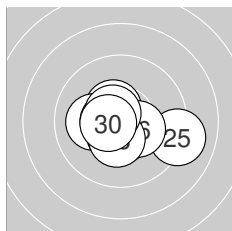

Serie 3: 103.3 (99)

10.5* ↖	10.5* ↓	10.1 ←	10.5* ↙	9.1 →
10.4* →	10.6* ←	10.4* ↓	10.6* ↖	10.6* ←

beste Teiler: 88.3 (29.), 97.0 (27.), 99.1 (30.)
Trefferlage: 0.00 mm, 0.39 mm tief
Streuwert: 1.40, horizontal: 1.81, vertikal: 0.82

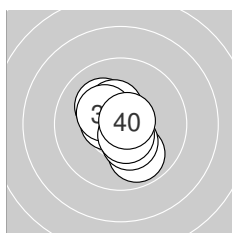

Serie 4: 104.6 (99)

10.8* ↖	10.2* ↖	10.8* ↗	9.9 ↓	10.3* ↘
10.4* ↖	10.6* ←	10.3* ↖	10.6* ↓	10.7* ↗

beste Teiler: 32.6 (31.), 46.1 (33.), 57.2 (40.)
Trefferlage: 0.14 mm links, 0.00 mm
Streuwert: 1.06, horizontal: 0.89, vertikal: 1.20



Ergebnis: 412.8 (392)
Serien: 103.5 103.6 102.8 102.9
Zähler: 32 8 0 0 0 0 0 0 0 0
Innenzehner: 28
Weiteste: 376 (4.), 350 (26.), 342 (2.)
beste Teiler: 16.1 (6.), 29.7 (5.), 41.7 (23.)
Trefferlage: 0.15 mm links, 0.00 mm
Streuwert: 1.33, horizontal: 1.53, vertikal: 1.09

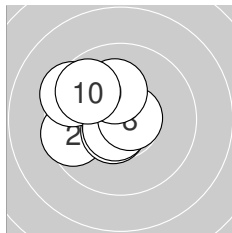
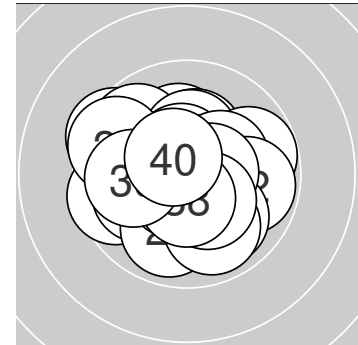

Serie 1: 103.5 (97)

10.8* ←	9.6 ←	10.6* ↙	9.4 ↘	10.8* ←
10.9* ↘	10.7* ↙	10.7* →	10.2* ↑	9.8 ↘

beste Teiler: 16.1 (6.), 29.7 (5.), 43.5 (1.)
Trefferlage: 1.03 mm links, 0.35 mm hoch
Streuwert: 1.27, horizontal: 1.40, vertikal: 1.12

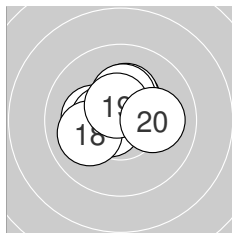

Serie 2: 103.6 (100)

10.4* ↑	10.3* ↑	10.7* ←	10.2* ←	10.5* ←
10.6* ←	10.3* ↑	10.0 ←	10.5* ↘	10.1 →

beste Teiler: 72.5 (13.), 82.2 (16.), 104.2 (19.)
Trefferlage: 0.36 mm links, 0.47 mm hoch
Streuwert: 1.10, horizontal: 1.27, vertikal: 0.89

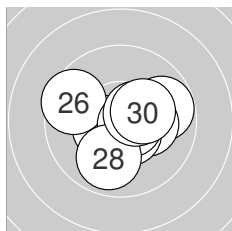

Serie 3: 102.8 (97)

9.8 →	10.2* →	10.8* →	10.5* ←	10.5* ↘
9.6 ←	10.7* ↘	9.9 ↓	10.5* →	10.3* →

beste Teiler: 41.7 (23.), 68.3 (27.), 101.8 (25.)
Trefferlage: 0.36 mm rechts, 0.09 mm tief
Streuwert: 1.43, horizontal: 1.72, vertikal: 1.07

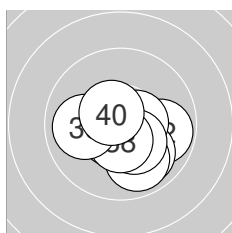

Serie 4: 102.9 (98)

10.7* ↘	9.8 →	10.0 ↘	10.6* ↙	10.5* →
9.9 ↘	10.3* ↘	10.5* ↓	10.0 ←	10.6* ↘

beste Teiler: 65.0 (31.), 89.8 (34.), 100.2 (40.)
Trefferlage: 0.42 mm rechts, 0.76 mm tief
Streuwert: 1.21, horizontal: 1.43, vertikal: 0.94



Ergebnis: **414.8** (398)
 Serien: 103.2 103.2 104.4 104.0
 Zähler: 38 2 0 0 0 0 0 0 0 0
 Innenzehner: 30
 Weitesten: 297 (27.), 275 (36.), 239 (7.)
 beste Teiler: 18.7 (25.), 42.2 (30.), 44.2 (24.)
 Trefferlage: 0.35 mm rechts, 0.16 mm hoch
 Streuwert: 1.11, horizontal: 1.22, vertikal: 1.00

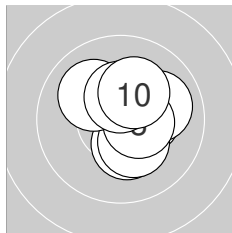
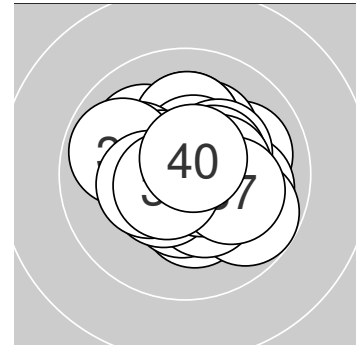

Serie 1: 103.2 (100)

10.4* →	10.4* ↗	10.6* ↘	10.3* ↓	10.3* ↘
10.1 ↖	10.0 →	10.5* →	10.4* ↑	10.2* ↗

beste Teiler: 82.7 (3.), 114.7 (8.), 139.0 (9.)
 Trefferlage: 0.68 mm rechts, 0.29 mm hoch
 Streuwert: 1.11, horizontal: 1.03, vertikal: 1.17

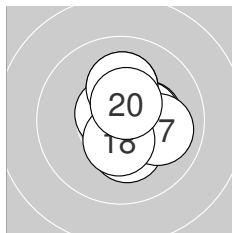

Serie 2: 103.2 (100)

10.1 ↑	10.3* ↑	10.3* →	10.7* ↖	10.4* →
10.3* ↓	10.0 →	10.5* ↓	10.1 ↑	10.5* ↑

beste Teiler: 74.3 (14.), 110.6 (20.), 124.4 (18.)
 Trefferlage: 0.56 mm rechts, 0.41 mm hoch
 Streuwert: 1.13, horizontal: 0.92, vertikal: 1.30

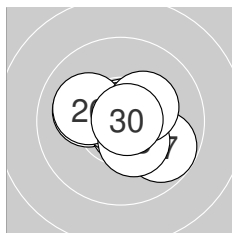

Serie 3: 104.4 (99)

10.1 ↖	10.5* →	10.7* ↘	10.8* ↗	10.9* ↖
10.1 ↖	9.8 ↘	10.4* ↘	10.3* ↗	10.8* →

beste Teiler: 18.7 (25.), 42.2 (30.), 44.2 (24.)
 Trefferlage: 0.27 mm rechts, 0.05 mm tief
 Streuwert: 1.16, horizontal: 1.41, vertikal: 0.83

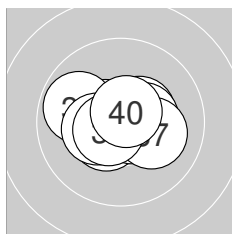

Serie 4: 104.0 (99)

10.5* ↖	10.5* ↗	10.6* ↘	10.4* ↗	10.4* →
9.9 ↖	10.1 →	10.3* ↖	10.6* ↗	10.7* ↗

beste Teiler: 74.7 (40.), 77.8 (33.), 89.0 (39.)
 Trefferlage: 0.11 mm links, 0.01 mm hoch
 Streuwert: 1.11, horizontal: 1.44, vertikal: 0.63



Ergebnis: **419.2** (398)
 Serien: 106.2 103.8 103.7 105.5
 Zähler: 38 2 0 0 0 0 0 0 0 0
 Innenzehner: 33
 Weitestе: 323 (36.), 251 (18.), 245 (34.)
 beste Teiler: 14.5 (6.), 21.0 (40.), 32.0 (7.)
 Trefferlage: 0.09 mm rechts, 0.06 mm hoch
 Streuwert: 1.00, horizontal: 1.15, vertikal: 0.84

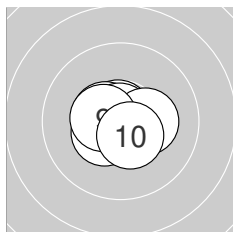
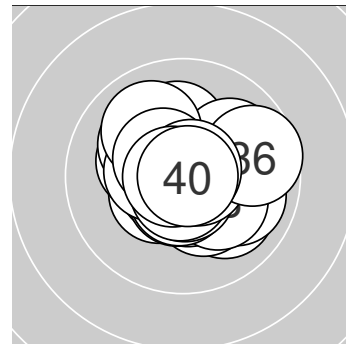

Serie 1: 106.2 (100)

10.4* ↙	10.8* ↘	10.8* →	10.7* ↑	10.5* ↖
10.9* ↑	10.8* ↑	10.3* →	10.5* ↖	10.5* ↘

beste Teiler: 14.5 (6.), 32.0 (7.), 40.4 (2.)
 Trefferlage: 0.05 mm links, 0.06 mm tief
 Streuwert: 0.71, horizontal: 0.88, vertikal: 0.49

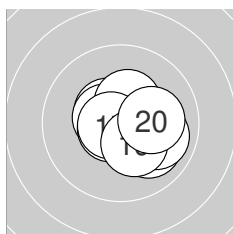

Serie 2: 103.8 (99)

10.5* ↘	10.7* ↘	10.5* ↖	10.0 ↘	10.4* ↑
10.7* ↙	10.7* ↖	9.9 →	10.3* ↘	10.1 →

beste Teiler: 57.9 (12.), 65.7 (17.), 73.8 (16.)
 Trefferlage: 0.50 mm rechts, 0.16 mm tief
 Streuwert: 1.10, horizontal: 1.28, vertikal: 0.89

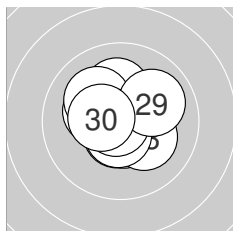

Serie 3: 103.7 (100)

10.6* ↓	10.6* ↓	10.2* ↘	10.2* ↑	10.6* ↓
10.2* ↖	10.1 ↖	10.8* ↖	10.0 ↗	10.4* ↖

beste Teiler: 32.8 (28.), 87.4 (25.), 91.2 (21.)
 Trefferlage: 0.15 mm links, 0.17 mm hoch
 Streuwert: 1.17, horizontal: 1.23, vertikal: 1.11

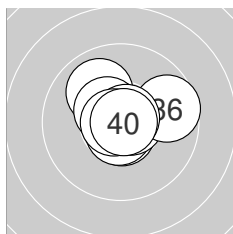

Serie 4: 105.5 (99)

10.7* ↓	10.7* ↓	10.7* →	10.0 ↘	10.7* ↘
9.7 →	10.5* ↘	10.8* ↗	10.8* ↖	10.9* →

beste Teiler: 21.0 (40.), 45.0 (39.), 45.6 (38.)
 Trefferlage: 0.10 mm rechts, 0.32 mm hoch
 Streuwert: 1.03, horizontal: 1.22, vertikal: 0.80



Ergebnis: **385.2** (366)
 Serien: 97.1 96.1 95.2 96.8
 Zähler: 14 18 8 0 0 0 0 0 0 0
 Innenzehner: 11
 Weitester: 665 (22.), 646 (3.), 635 (37.)
 beste Teiler: 30.8 (10.), 88.1 (26.), 97.2 (32.)
 Trefferlage: 1.44 mm rechts, 0.28 mm hoch
 Streuwert: 2.46, horizontal: 2.61, vertikal: 2.29

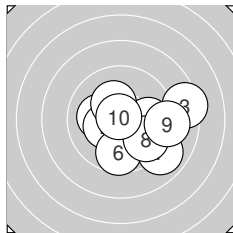
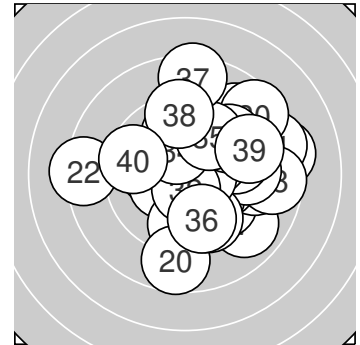

Serie 1: 97.1 (92)

10.1 ←	10.3* ↙	8.4 →	9.9 →	10.3* ↖
9.6 ↓	8.9 ↘	9.7 ↘	9.1 →	10.8* ↖

beste Teiler: 30.8 (10.), 158.8 (2.), 168.7 (5.)
 Trefferlage: 1.54 mm rechts, 0.62 mm tief
 Streuwert: 2.34, horizontal: 2.84, vertikal: 1.69

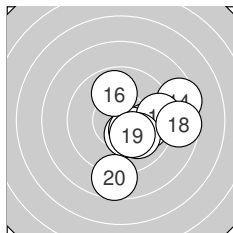

Serie 2: 96.1 (91)

9.9 →	10.3* ↘	10.4* ↘	8.5 →	9.4 →
9.9 ↑	10.1 ↘	8.7 →	10.2* ↘	8.7 ↓

beste Teiler: 143.7 (13.), 153.5 (12.), 181.9 (19.)
 Trefferlage: 2.10 mm rechts, 0.69 mm tief
 Streuwert: 2.28, horizontal: 2.32, vertikal: 2.24

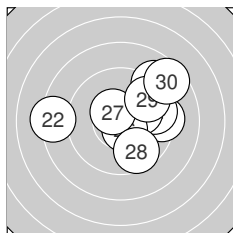

Serie 3: 95.2 (91)

9.3 →	8.3 ←	9.0 ↗	9.6 →	10.1 →
10.6* ↘	10.5* ↖	9.6 ↘	9.6 ↗	8.6 ↗

beste Teiler: 88.1 (26.), 119.3 (27.), 209.8 (25.)
 Trefferlage: 1.42 mm rechts, 0.93 mm hoch
 Streuwert: 2.72, horizontal: 3.27, vertikal: 2.03

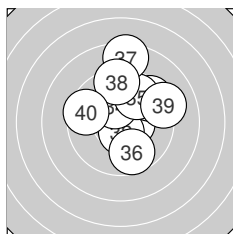

Serie 4: 96.8 (92)

10.5* →	10.6* ↓	9.5 ↗	10.3* ↖	9.8 ↗
9.7 ↘	8.4 ↑	9.4 ↑	9.1 →	9.5 ←

beste Teiler: 97.2 (32.), 115.2 (31.), 168.2 (34.)
 Trefferlage: 0.71 mm rechts, 1.52 mm hoch
 Streuwert: 2.34, horizontal: 2.06, vertikal: 2.58



Ergebnis: **389.0** (370)
 Serien: 85.5 100.3 102.8 100.4
 Zähler: 24 11 3 1 0 0 0 0 0 0 1
 Innenzehner: 21
 Weitesten: 8307 (10.), 851 (9.), 686 (7.)
 beste Teiler: 26.9 (13.), 40.2 (27.), 52.9 (21.)
 Trefferlage: 1.17 mm links, 1.95 mm tief
 Streuwert: 9.51, horizontal: 1.48, vertikal: 13.37

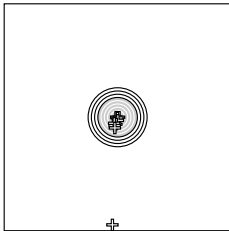
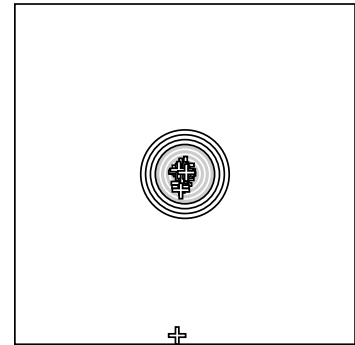

Serie 1: 85.5 (81)

10.5* ←	10.5* ←	10.5* →	10.7* ↓	10.0 ↓
8.8 ↓	8.2 ↓	8.8 ↙	7.5 ↓	0.0 ↓

beste Teiler: 61.5 (4.), 102.4 (2.), 110.0 (3.)
 Trefferlage: 1.28 mm links, 11.08 mm tief
 Streuwert: 18.02, horizontal: 1.51, vertikal: 25.44

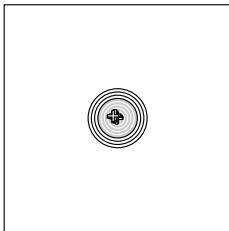

Serie 2: 100.3 (95)

10.3* ↘	9.9 ←	10.8* ↘	9.8 ↘	10.1 ←
10.6* ←	9.5 ←	10.1 ↘	9.8 ↘	9.4 ↘

beste Teiler: 26.9 (13.), 78.1 (16.), 153.8 (11.)
 Trefferlage: 1.87 mm links, 1.13 mm hoch
 Streuwert: 0.98, horizontal: 1.13, vertikal: 0.81

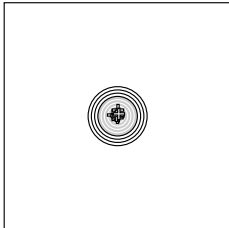

Serie 3: 102.8 (98)

10.7* →	10.4* ↘	9.5 ←	10.5* ↓	10.5* ↑
9.1 ↑	10.8* ↘	10.6* ←	10.5* ↗	10.2* ↗

beste Teiler: 40.2 (27.), 52.9 (21.), 92.6 (28.)
 Trefferlage: 0.35 mm links, 0.93 mm hoch
 Streuwert: 1.41, horizontal: 1.26, vertikal: 1.55

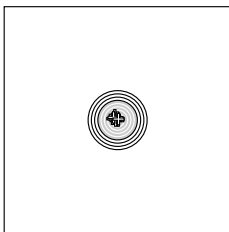

Serie 4: 100.4 (96)

10.4* ↗	9.2 ↘	9.7 ←	10.7* ↘	10.6* ↑
10.4* ←	9.3 ←	10.2* ↑	9.4 ↘	10.5* ↗

beste Teiler: 57.8 (34.), 86.5 (35.), 106.3 (40.)
 Trefferlage: 1.18 mm links, 1.20 mm hoch
 Streuwert: 1.49, horizontal: 1.74, vertikal: 1.19



Ergebnis: 399.3 (382)
Serien: 97.2 99.9 102.0 100.2
Zähler: 24 14 2 0 0 0 0 0 0 0
Innenzehner: 15
Weiteste: 645 (3.), 507 (6.), 445 (31.)
beste Teiler: 9.0 (11.), 38.3 (23.), 55.3 (26.)
Trefferlage: 0.08 mm links, 0.22 mm hoch
Streuwert: 1.97, horizontal: 2.33, vertikal: 1.53

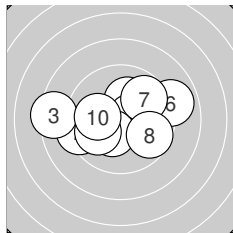
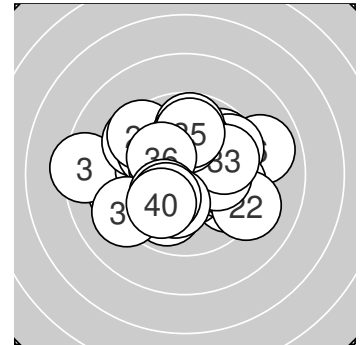

Serie 1: 97.2 (93)

10.2* ↑	9.3 ←	8.4 ←	10.5* →	10.3* ↓
8.9 →	9.8 ↗	9.7 ↘	10.0 ←	10.1 ←

beste Teiler: 106.3 (4.), 156.7 (5.), 193.8 (1.)
Trefferlage: 0.40 mm links, 0.10 mm hoch
Streuwert: 2.59, horizontal: 3.39, vertikal: 1.37

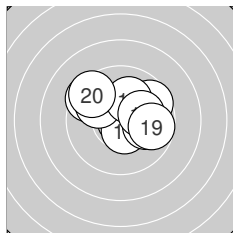

Serie 2: 99.9 (95)

10.9* ↓	9.5 ↘	10.5* ↓	9.7 →	10.0 →
9.9 ↘	10.1 ↑	10.1 →	9.7 →	9.5 ↘

beste Teiler: 9.0 (11.), 106.9 (13.), 208.1 (18.)
Trefferlage: 0.34 mm rechts, 0.79 mm hoch
Streuwert: 1.87, horizontal: 2.31, vertikal: 1.29

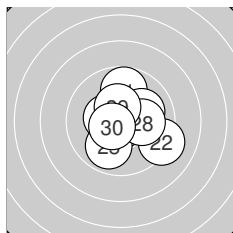

Serie 3: 102.0 (97)

9.8 ↑	9.2 ↘	10.8* ↓	10.1 →	9.9 ↓
10.7* ↑	10.4* ←	10.1 →	10.4* ↑	10.6* ←

beste Teiler: 38.3 (23.), 55.3 (26.), 96.8 (30.)
Trefferlage: 0.46 mm rechts, 0.07 mm hoch
Streuwert: 1.63, horizontal: 1.69, vertikal: 1.56

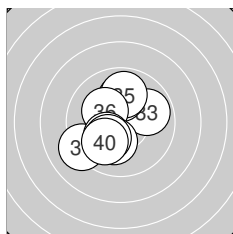

Serie 4: 100.2 (97)

9.2 ←	10.4* ↑	9.9 →	10.0 ↑	9.9 ↑
10.2* ↘	10.2* ↓	10.2* ↓	10.2* ↓	10.0 ↓

beste Teiler: 142.5 (32.), 186.2 (36.), 186.6 (37.)
Trefferlage: 0.72 mm links, 0.05 mm tief
Streuwert: 1.77, horizontal: 1.62, vertikal: 1.92



Ergebnis: **420.2** (399)
 Serien: 104.7 104.6 105.4 105.5
 Zähler: 39 1 0 0 0 0 0 0 0 0
 Innenzehner: 38
 Weitester: 252 (33.), 207 (40.), 197 (7.)
 beste Teiler: 8.0 (2.), 12.5 (28.), 19.4 (39.)
 Trefferlage: 0.06 mm rechts, 0.04 mm hoch
 Streuwert: 0.90, horizontal: 0.94, vertikal: 0.87

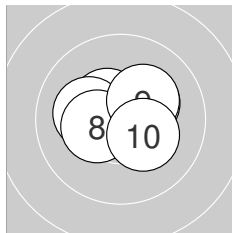
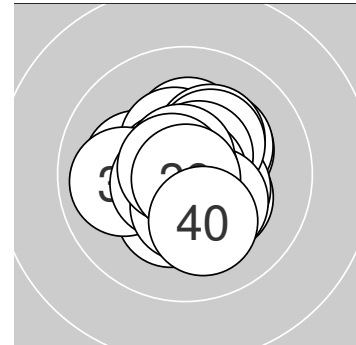

Serie 1: 104.7 (100)

10.6* ↖	10.9* →	10.3* ↗	10.7* ↖	10.7* ↗
10.5* ↖	10.2* ←	10.3* ←	10.2* ↗	10.3* ↘

beste Teiler: 8.0 (2.), 58.0 (5.), 60.8 (4.)
 Trefferlage: 0.03 mm links, 0.34 mm hoch
 Streuwert: 0.97, horizontal: 1.20, vertikal: 0.66

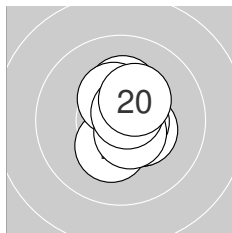

Serie 2: 104.6 (100)

10.3* ↑	10.4* ↘	10.6* ↘	10.3* ↓	10.4* ↘
10.4* ↖	10.6* →	10.6* ↘	10.7* ↗	10.3* ↗

beste Teiler: 62.3 (19.), 76.2 (13.), 76.5 (17.)
 Trefferlage: 0.49 mm rechts, 0.08 mm hoch
 Streuwert: 0.88, horizontal: 0.62, vertikal: 1.08

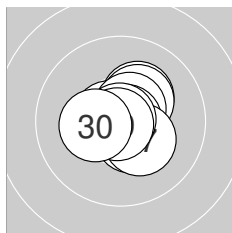

Serie 3: 105.4 (100)

10.2* ↗	10.7* ↖	10.3* ↗	10.6* ↗	10.5* ↘
10.8* →	10.3* ↘	10.9* ↖	10.8* ↗	10.3* ←

beste Teiler: 12.5 (28.), 28.3 (29.), 30.1 (26.)
 Trefferlage: 0.22 mm rechts, 0.13 mm hoch
 Streuwert: 0.86, horizontal: 0.87, vertikal: 0.85

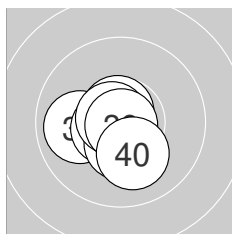

Serie 4: 105.5 (99)

10.6* ↓	10.8* ←	9.9 ←	10.8* ↖	10.6* ←
10.7* ↖	10.4* ↓	10.7* ↖	10.9* ↓	10.1 ↓

beste Teiler: 19.4 (39.), 41.6 (34.), 47.5 (32.)
 Trefferlage: 0.42 mm links, 0.37 mm tief
 Streuwert: 0.82, horizontal: 0.85, vertikal: 0.80



Ergebnis: **413.1** (393)
 Serien: 101.3 102.2 105.3 104.3
 Zähler: 33 7 0 0 0 0 0 0 0 0
 Innenzehner: 28
 Weitestе: 402 (1.), 396 (18.), 331 (36.)
 beste Teiler: 5.0 (40.), 13.4 (22.), 28.0 (29.)
 Trefferlage: 0.24 mm rechts, 0.33 mm hoch
 Streuwert: 1.29, horizontal: 1.45, vertikal: 1.11

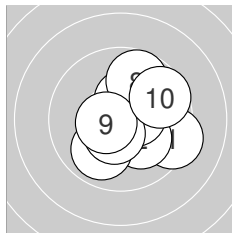
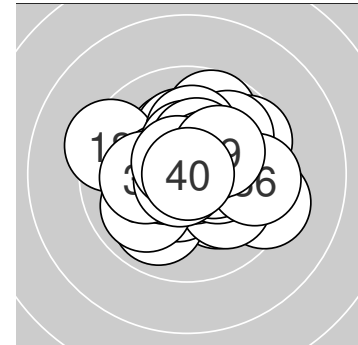

Serie 1: 101.3 (96)

9.3 ↘	10.1 ↘	10.8* ↙	10.4* ↑	9.9 ↙
10.5* →	10.5* ↙	9.7 ↑	10.5* ←	9.6 ↘

beste Teiler: 37.0 (3.), 108.1 (9.), 111.3 (6.)
 Trefferlage: 0.75 mm rechts, 0.04 mm tief
 Streuwert: 1.62, horizontal: 1.67, vertikal: 1.57

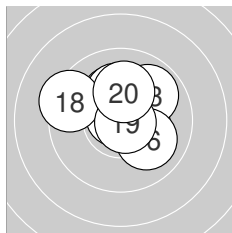

Serie 2: 102.2 (98)

10.4* →	10.4* ↑	9.9 ↗	10.2* ↖	10.8* ↘
10.0 ↘	10.2* ↑	9.4 ↖	10.8* →	10.1 ↑

beste Teiler: 38.9 (19.), 44.5 (15.), 142.2 (11.)
 Trefferlage: 0.06 mm rechts, 0.88 mm hoch
 Streuwert: 1.43, horizontal: 1.63, vertikal: 1.18

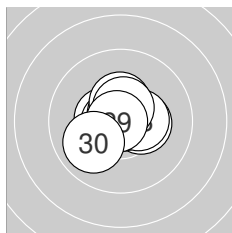

Serie 3: 105.3 (100)

10.4* →	10.9* ↗	10.4* →	10.5* ←	10.7* ←
10.7* ↖	10.4* ↑	10.5* ↑	10.8* ←	10.0 ↙

beste Teiler: 13.4 (22.), 28.0 (29.), 56.3 (26.)
 Trefferlage: 0.11 mm links, 0.14 mm hoch
 Streuwert: 0.91, horizontal: 1.03, vertikal: 0.77

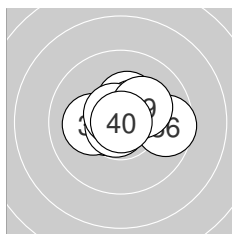

Serie 4: 104.3 (99)

10.3* ↑	10.5* ←	10.1 ←	10.7* ↗	10.8* ↙
9.6 →	10.5* ↗	10.7* ↘	10.2* ↗	10.9* →

beste Teiler: 5.0 (40.), 46.7 (35.), 67.6 (34.)
 Trefferlage: 0.29 mm rechts, 0.34 mm hoch
 Streuwert: 1.12, horizontal: 1.46, vertikal: 0.63



Ergebnis: **407.0** (386)
 Serien: 103.2 100.3 100.3 103.2
 Zähler: 26 14 0 0 0 0 0 0 0 0
 Innenzehner: 24
 Weitesten: 393 (3.), 387 (11.), 355 (25.)
 beste Teiler: 39.1 (27.), 48.8 (10.), 49.2 (8.)
 Trefferlage: 0.45 mm rechts, 0.13 mm tief
 Streuwert: 1.56, horizontal: 1.40, vertikal: 1.71

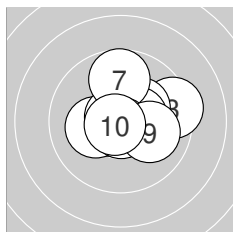
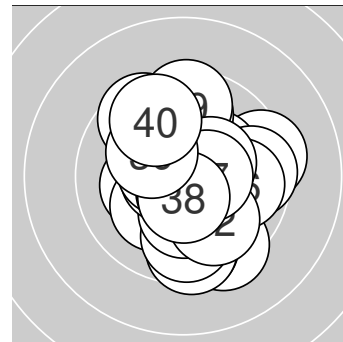

Serie 1: 103.2 (98)

10.6* ←	10.2* ←	9.4 →	10.3* ↗	10.8* ↘
10.5* →	9.7 ↑	10.8* ↓	10.1 →	10.8* ↗

beste Teiler: 48.8 (10.), 49.2 (8.), 50.6 (5.)
 Trefferlage: 0.49 mm rechts, 0.33 mm hoch
 Streuwert: 1.41, horizontal: 1.64, vertikal: 1.13

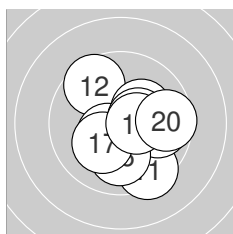

Serie 2: 100.3 (96)

9.4 ↓	9.6 ↘	10.5* ↗	9.9 →	10.2* ↗
10.0 ↓	10.2* ↗	10.4* →	10.5* →	9.6 →

beste Teiler: 117.0 (19.), 123.5 (13.), 132.4 (18.)
 Trefferlage: 0.77 mm rechts, 0.38 mm tief
 Streuwert: 1.74, horizontal: 1.77, vertikal: 1.72

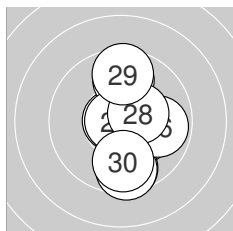

Serie 3: 100.3 (94)

10.7* ←	9.8 ↑	10.2* ↘	9.6 ↓	9.5 ↓
9.9 →	10.8* ←	10.4* →	9.6 ↑	9.8 ↓

beste Teiler: 39.1 (27.), 56.2 (21.), 141.0 (28.)
 Trefferlage: 0.60 mm rechts, 0.40 mm tief
 Streuwert: 1.86, horizontal: 0.99, vertikal: 2.43

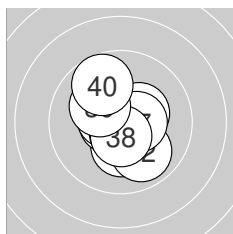

Serie 4: 103.2 (98)

10.2* ↓	9.9 ↘	10.6* ←	10.5* ←	10.7* ↓
10.4* ↗	10.5* →	10.5* ↓	10.2* ↘	9.7 ↘

beste Teiler: 74.1 (35.), 81.2 (33.), 102.0 (38.)
 Trefferlage: 0.05 mm links, 0.08 mm tief
 Streuwert: 1.28, horizontal: 1.11, vertikal: 1.43



LG 40 ZR

StandNr: 51

Zehetner, Anita #256

Frauen

Wertung

NÖ – SPS Leonhofen / Niederösterreich 1

StartNr: 268

30.03.2023 14:45

Ergebnis: **414.6** (396)
 Serien: 104.5 103.6 102.4 104.1
 Zähler: 36 4 0 0 0 0 0 0 0 0
 Innenzehner: 33
 Weitestе: 451 (26.), 368 (22.), 264 (34.)
 beste Teiler: 37.4 (21.), 45.4 (40.), 47.1 (30.)
 Trefferlage: 0.20 mm links, 0.21 mm tief
 Streuwert: 1.20, horizontal: 1.39, vertikal: 0.98

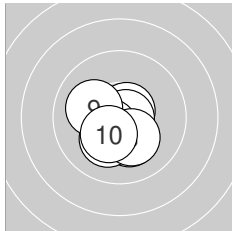
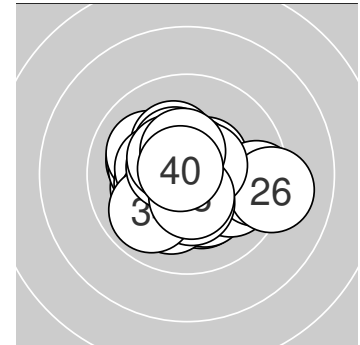
**Serie 1: 104.5 (100)**

10.8* ↖	10.2* ↓	10.2* ↗	10.7* ↓	10.7* ↗
10.8* →	10.5* ↗	10.2* ↓	10.1 ↖	10.3* ↓

beste Teiler: 49.4 (6.), 49.6 (1.), 55.3 (4.)
 Trefferlage: 0.24 mm links, 0.67 mm tief
 Streuwert: 0.91, horizontal: 0.94, vertikal: 0.89

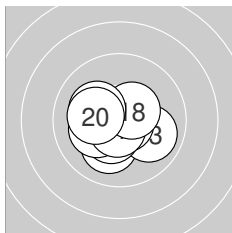
**Serie 2: 103.6 (99)**

10.1 ↓	10.7* ↗	9.9 →	10.4* ↓	10.2* ↖
10.7* →	10.7* ↓	10.5* ↗	10.2* ↖	10.2* ↖

beste Teiler: 51.9 (16.), 55.3 (12.), 69.6 (17.)
 Trefferlage: 0.29 mm links, 0.35 mm tief
 Streuwert: 1.16, horizontal: 1.36, vertikal: 0.92

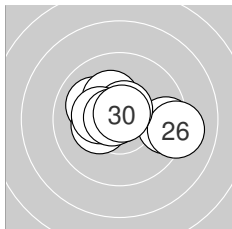
**Serie 3: 102.4 (98)**

10.8* ↖	9.5 →	10.0 ↖	10.3* ↖	10.3* ↖
9.1 →	10.6* ↗	10.3* ↖	10.7* ↖	10.8* ↗

beste Teiler: 37.4 (21.), 47.1 (30.), 61.6 (29.)
 Trefferlage: 0.19 mm rechts, 0.28 mm hoch
 Streuwert: 1.63, horizontal: 2.18, vertikal: 0.75

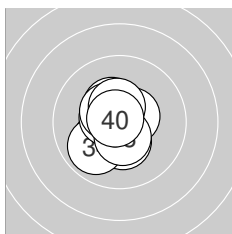
**Serie 4: 104.1 (99)**

10.3* ↓	10.2* ↗	10.4* ↖	9.9 ↗	10.5* ↖
10.5* ↗	10.5* ↖	10.5* ↓	10.5* ↑	10.8* ↖

beste Teiler: 45.4 (40.), 101.9 (35.), 104.2 (36.)
 Trefferlage: 0.48 mm links, 0.13 mm tief
 Streuwert: 1.03, horizontal: 0.83, vertikal: 1.19



Ergebnis: **411.9** (392)
 Serien: 102.6 104.5 103.9 100.9
 Zähler: 33 6 1 0 0 0 0 0 0 0
 Innenzehner: 29
 Weitester: 570 (6.), 368 (35.), 337 (32.)
 beste Teiler: 6.0 (2.), 17.4 (11.), 20.0 (13.)
 Trefferlage: 0.25 mm rechts, 0.14 mm hoch
 Streuwert: 1.39, horizontal: 1.66, vertikal: 1.05

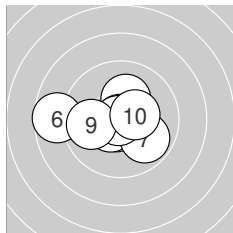
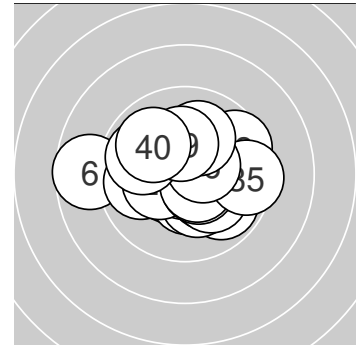

Serie 1: 102.6 (96)

10.2* ↑	10.9* ←	10.6* ↘	10.6* ↙	10.5* ↙
8.7 ←	9.9 ↘	10.9* ↙	9.9 ←	10.4* →

beste Teiler: 6.0 (2.), 22.4 (8.), 76.9 (4.)
 Trefferlage: 0.52 mm links, 0.18 mm tief
 Streuwert: 1.70, horizontal: 2.23, vertikal: 0.90

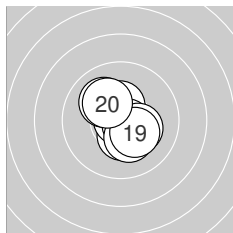

Serie 2: 104.5 (100)

10.9* ↘	10.4* ↓	10.9* ←	10.4* ↑	10.7* ↘
10.3* ↘	10.1 ↘	10.3* ↘	10.3* ↘	10.2* ↘

beste Teiler: 17.4 (11.), 20.0 (13.), 64.4 (15.)
 Trefferlage: 0.14 mm rechts, 0.06 mm tief
 Streuwert: 1.08, horizontal: 0.97, vertikal: 1.19

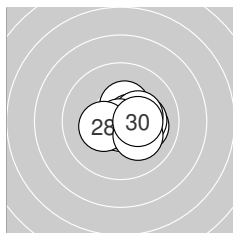

Serie 3: 103.9 (100)

10.4* ↑	10.1 →	10.6* →	10.8* ↓	10.2* →
10.3* →	10.8* ↙	10.3* ←	10.1 ↘	10.3* →

beste Teiler: 26.0 (27.), 47.0 (24.), 90.2 (23.)
 Trefferlage: 0.82 mm rechts, 0.08 mm tief
 Streuwert: 0.95, horizontal: 1.14, vertikal: 0.70

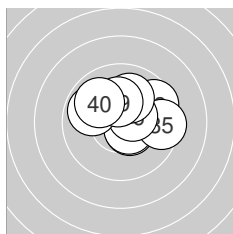

Serie 4: 100.9 (96)

10.5* ↘	9.6 ↗	10.6* ↘	10.2* ↑	9.5 →
10.5* →	9.9 ↖	10.0 ↑	10.2* ↑	9.9 ↘

beste Teiler: 97.1 (33.), 111.1 (31.), 120.3 (36.)
 Trefferlage: 0.58 mm rechts, 0.89 mm hoch
 Streuwert: 1.55, horizontal: 1.89, vertikal: 1.09



Ergebnis: **411.2** (393)
 Serien: 102.4 102.6 104.3 101.9
 Zähler: 33 7 0 0 0 0 0 0 0 0
 Innenzehner: 27
 Weitesten: 400 (23.), 345 (13.), 327 (39.)
 beste Teiler: 20.2 (22.), 24.0 (21.), 38.0 (17.)
 Trefferlage: 0.02 mm rechts, 0.49 mm tief
 Streuwert: 1.33, horizontal: 1.51, vertikal: 1.12

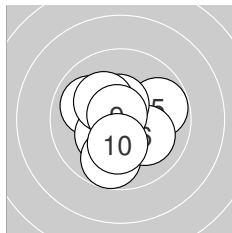
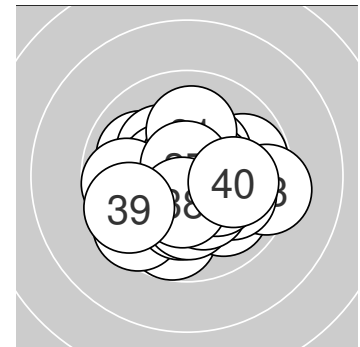

Serie 1: 102.4 (98)

10.0 ↖	10.7* ↓	10.3* ↗	9.8 ↓	9.8 →
10.1 ↘	10.5* ↑	10.2* ↖	10.8* ↖	10.2* ↓

beste Teiler: 42.6 (9.), 71.6 (2.), 111.7 (7.)
 Trefferlage: 0.11 mm links, 0.31 mm tief
 Streuwert: 1.46, horizontal: 1.48, vertikal: 1.44

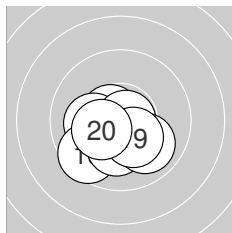

Serie 2: 102.6 (98)

10.6* ↖	10.1 ←	9.6 ↗	10.4* ↗	10.4* ↓
10.2* ↓	10.8* →	9.9 ↘	10.3* ↓	10.3* ↗

beste Teiler: 38.0 (17.), 85.0 (11.), 134.1 (15.)
 Trefferlage: 0.40 mm links, 1.01 mm tief
 Streuwert: 1.15, horizontal: 1.35, vertikal: 0.90

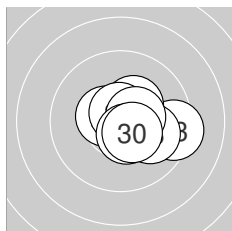

Serie 3: 104.3 (99)

10.9* ↑	10.9* ↖	9.4 →	10.4* ↗	10.5* ↖
10.0 ↘	10.7* ↑	10.5* →	10.5* ↓	10.5* ↓

beste Teiler: 20.2 (22.), 24.0 (21.), 64.9 (27.)
 Trefferlage: 0.82 mm rechts, 0.05 mm tief
 Streuwert: 1.13, horizontal: 1.41, vertikal: 0.74

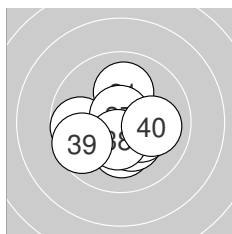

Serie 4: 101.9 (98)

10.1 ↑	10.2* ↓	10.3* ↓	10.3* ↘	10.5* ↗
9.7 ←	10.8* ↑	10.4* ↓	9.6 ↖	10.0 →

beste Teiler: 49.4 (37.), 117.2 (35.), 132.8 (38.)
 Trefferlage: 0.20 mm links, 0.57 mm tief
 Streuwert: 1.47, horizontal: 1.69, vertikal: 1.21



Ergebnis: 418.9 (398)
Serien: 105.4 105.7 103.7 104.1
Zähler: 38 2 0 0 0 0 0 0 0 0
Innenzehner: 32
Weiteste: 257 (36.), 256 (15.), 250 (29.)
beste Teiler: 24.0 (18.), 30.4 (14.), 34.0 (31.)
Trefferlage: 0.03 mm links, 0.06 mm hoch
Streuwert: 0.99, horizontal: 1.06, vertikal: 0.92

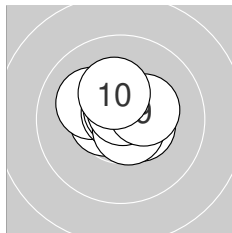
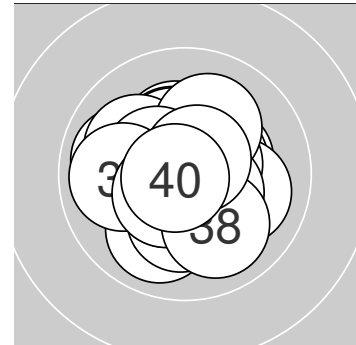

Serie 1: 105.4 (100)

10.5* →	10.6* ←	10.1 ↖	10.8* ↗	10.8* ↖
10.7* ↑	10.6* ↘	10.7* ↑	10.3* →	10.3* ↑

beste Teiler: 36.4 (4.), 45.1 (5.), 60.4 (6.)
Trefferlage: 0.00 mm , 0.40 mm hoch
Streuwert: 0.81, horizontal: 0.95, vertikal: 0.65

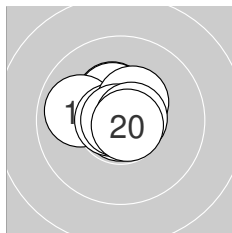

Serie 2: 105.7 (99)

10.4* ↖	10.4* ↖	10.8* →	10.8* ↓	9.9 ←
10.7* ←	10.4* ↗	10.9* ←	10.7* →	10.7* ↘

beste Teiler: 24.0 (18.), 30.4 (14.), 39.4 (13.)
Trefferlage: 0.22 mm links, 0.39 mm hoch
Streuwert: 0.82, horizontal: 0.95, vertikal: 0.67

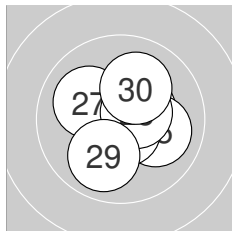

Serie 3: 103.7 (100)

10.7* →	10.4* ↗	10.7* ↖	10.5* →	10.0 →
10.7* ↓	10.1 ↖	10.5* →	10.0 ↓	10.1 ↑

beste Teiler: 65.3 (21.), 66.3 (23.), 72.8 (26.)
Trefferlage: 0.36 mm rechts, 0.01 mm hoch
Streuwert: 1.18, horizontal: 1.22, vertikal: 1.14

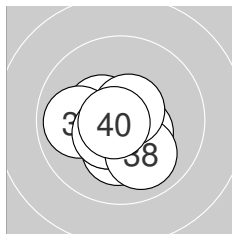

Serie 4: 104.1 (99)

10.8* ↓	10.2* ↓	10.4* ↖	10.4* ↘	10.5* ↗
9.9 ←	10.5* ↗	10.0 ↓	10.6* ↗	10.8* ↖

beste Teiler: 34.0 (31.), 44.0 (40.), 79.6 (39.)
Trefferlage: 0.29 mm links, 0.56 mm tief
Streuwert: 1.02, horizontal: 1.13, vertikal: 0.89



Ergebnis: 415.9 (397)
Serien: 104.4 104.5 102.8 104.2
Zähler: 37 3 0 0 0 0 0 0 0 0 0
Innenzehner: 33
Weiteste: 297 (37.), 284 (4.), 280 (29.)
beste Teiler: 29.9 (33.), 32.6 (19.), 42.0 (11.)
Trefferlage: 0.66 mm links, 0.17 mm hoch
Streuwert: 1.00, horizontal: 1.03, vertikal: 0.96

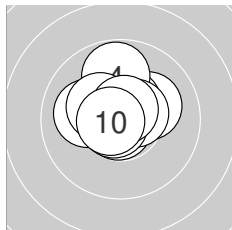
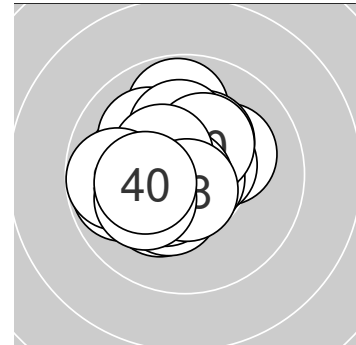

Serie 1: 104.4 (99)

10.1 ←	10.2* ↗	10.5* ↗	9.8 ↑	10.3* ↘
10.8* ↓	10.6* ↗	10.7* ↘	10.7* ↑	10.7* ←

beste Teiler: 46.8 (6.), 53.2 (8.), 67.2 (10.)
Trefferlage: 0.17 mm links, 0.61 mm hoch
Streuwert: 1.03, horizontal: 1.12, vertikal: 0.93

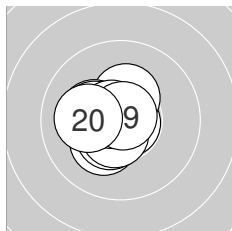

Serie 2: 104.5 (100)

10.8* ↘	10.3* ↑	10.2* ↘	10.2* ←	10.5* ↓
10.6* ↓	10.3* ←	10.7* ↘	10.8* ↑	10.1 ←

beste Teiler: 32.6 (19.), 42.0 (11.), 70.7 (18.)
Trefferlage: 0.75 mm links, 0.04 mm tief
Streuwert: 0.88, horizontal: 0.91, vertikal: 0.84

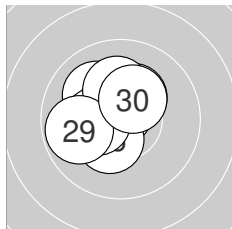

Serie 3: 102.8 (99)

10.3* ↘	10.7* ↑	10.3* ↗	10.4* ↑	10.4* ↓
10.1 ↘	10.3* ←	10.2* ↑	9.8 ←	10.3* ↗

beste Teiler: 51.1 (22.), 139.1 (24.), 150.7 (25.)
Trefferlage: 0.66 mm links, 0.50 mm hoch
Streuwert: 1.16, horizontal: 1.12, vertikal: 1.19

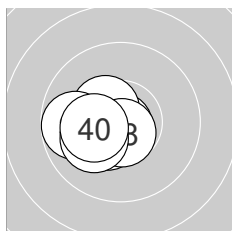

Serie 4: 104.2 (99)

10.8* ↘	10.6* ↘	10.8* ↓	10.4* ↘	10.4* ←
10.4* ↘	9.8 ←	10.7* ↓	10.1 ←	10.2* ←

beste Teiler: 29.9 (33.), 49.2 (31.), 70.4 (38.)
Trefferlage: 1.09 mm links, 0.38 mm tief
Streuwert: 0.73, horizontal: 0.89, vertikal: 0.52



Ergebnis: **415.1** (397)
 Serien: 103.7 104.4 104.6 102.4
 Zähler: 37 3 0 0 0 0 0 0 0 0 0
 Innenzehner: 32
 Weitestе: 391 (3.), 332 (34.), 317 (40.)
 beste Teiler: 13.1 (4.), 19.2 (27.), 30.0 (12.)
 Trefferlage: 0.22 mm links, 0.05 mm hoch
 Streuwert: 1.17, horizontal: 1.31, vertikal: 1.01

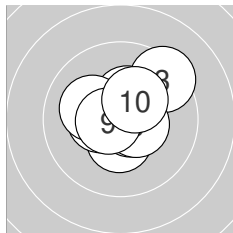
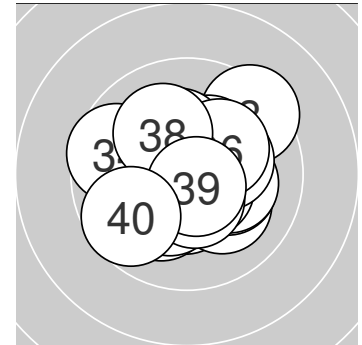

Serie 1: 103.7 (99)

10.4* ↓	10.4* ↑	9.4 ↗	10.9* ←	10.4* ←
10.7* →	10.1 ↖	10.5* →	10.6* ←	10.3* ↗

beste Teiler: 13.1 (4.), 72.9 (6.), 82.8 (9.)
 Trefferlage: 0.16 mm rechts, 0.39 mm hoch
 Streuwert: 1.26, horizontal: 1.36, vertikal: 1.15

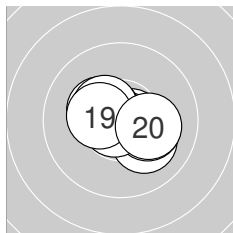

Serie 2: 104.4 (100)

10.7* →	10.8* ↘	10.1 ↘	10.2* →	10.5* ↖
10.3* ↖	10.8* ↗	10.4* ↖	10.4* ←	10.2* →

beste Teiler: 30.0 (12.), 47.1 (17.), 68.8 (11.)
 Trefferlage: 0.09 mm rechts, 0.04 mm tief
 Streuwert: 1.05, horizontal: 1.33, vertikal: 0.66

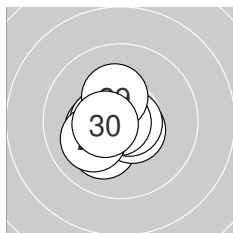

Serie 3: 104.6 (100)

10.6* ↖	10.1 ↗	10.6* ↘	10.7* →	10.3* ←
10.5* ←	10.9* ↗	10.1 ↗	10.3* ↑	10.5* ←

beste Teiler: 19.2 (27.), 59.4 (24.), 89.4 (21.)
 Trefferlage: 0.66 mm links, 0.22 mm tief
 Streuwert: 0.89, horizontal: 0.87, vertikal: 0.91

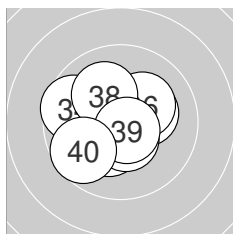

Serie 4: 102.4 (98)

10.4* ↖	10.3* ↗	10.7* ↖	9.6 ←	10.2* →
10.2* ↗	10.5* ↘	10.1 ↖	10.7* ↘	9.7 ↗

beste Teiler: 59.5 (33.), 70.0 (39.), 115.7 (37.)
 Trefferlage: 0.49 mm links, 0.11 mm hoch
 Streuwert: 1.43, horizontal: 1.58, vertikal: 1.27



Ergebnis: **414.7** (397)
 Serien: 103.4 104.4 103.7 103.2
 Zähler: 37 3 0 0 0 0 0 0 0 0
 Innenzehner: 34
 Weitesten: 301 (33.), 287 (22.), 258 (4.)
 beste Teiler: 44.2 (36.), 65.5 (32.), 78.0 (31.)
 Trefferlage: 0.02 mm rechts, 0.31 mm hoch
 Streuwert: 1.11, horizontal: 1.12, vertikal: 1.09

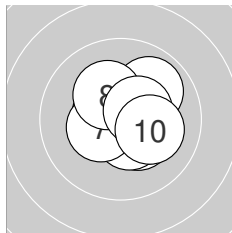
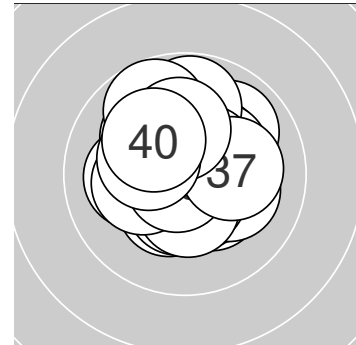

Serie 1: 103.4 (99)

10.6* ←	10.5* →	10.3* ↘	9.9 ↗	10.3* ↘
10.5* ↓	10.4* ←	10.2* ↖	10.5* ↗	10.2* ↘

beste Teiler: 96.4 (1.), 107.7 (2.), 119.4 (6.)
 Trefferlage: 0.60 mm rechts, 0.00 mm
 Streuwert: 1.11, horizontal: 1.18, vertikal: 1.04

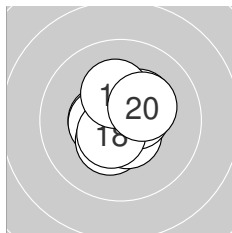

Serie 2: 104.4 (100)

10.5* ←	10.5* →	10.5* ←	10.4* ↘	10.3* ↗
10.6* ↓	10.5* →	10.5* ↘	10.3* ↑	10.3* ↗

beste Teiler: 99.7 (16.), 103.7 (12.), 104.0 (17.)
 Trefferlage: 0.09 mm rechts, 0.12 mm hoch
 Streuwert: 0.98, horizontal: 1.00, vertikal: 0.97

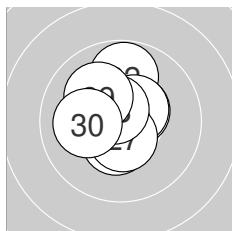

Serie 3: 103.7 (99)

10.4* ↓	9.8 ↑	10.6* ↗	10.5* ↗	10.6* ↘
10.5* ↗	10.5* ↓	10.6* ↘	10.1 ↘	10.1 ←

beste Teiler: 85.8 (28.), 90.4 (23.), 91.0 (25.)
 Trefferlage: 0.21 mm links, 0.53 mm hoch
 Streuwert: 1.11, horizontal: 1.02, vertikal: 1.19

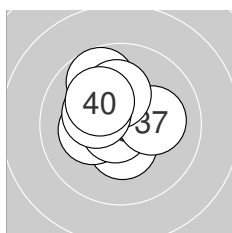

Serie 4: 103.2 (99)

10.6* ↗	10.7* ↑	9.7 ↘	10.4* ↓	10.2* ←
10.8* ↘	10.1 →	10.2* ↑	10.3* ↘	10.2* ↘

beste Teiler: 44.2 (36.), 65.5 (32.), 78.0 (31.)
 Trefferlage: 0.36 mm links, 0.61 mm hoch
 Streuwert: 1.19, horizontal: 1.18, vertikal: 1.19



Ergebnis: **419.2** (399)
 Serien: 103.9 104.5 105.1 105.7
 Zähler: 39 1 0 0 0 0 0 0 0 0
 Innenzehner: 33
 Weitesten: 302 (4.), 239 (23.), 232 (13.)
 beste Teiler: 30.6 (40.), 41.5 (26.), 43.4 (30.)
 Trefferlage: 0.43 mm rechts, 0.36 mm tief
 Streuwert: 0.90, horizontal: 0.87, vertikal: 0.93

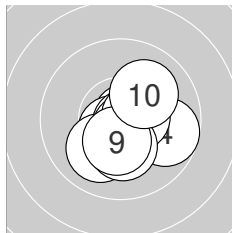
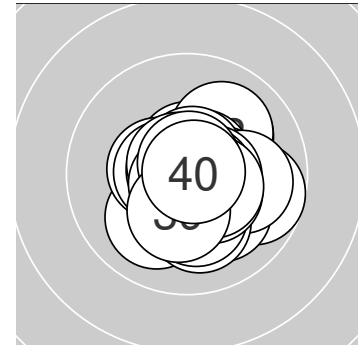

Serie 1: 103.9 (99)

10.8* →	10.6* ↙	10.8* ↘	9.7 →	10.7* ↘
10.6* →	10.0 ↙	10.2* ↓	10.4* ↓	10.1 ↗

beste Teiler: 43.9 (1.), 49.0 (3.), 70.7 (5.)
 Trefferlage: 0.47 mm rechts, 0.55 mm tief
 Streuwert: 1.11, horizontal: 1.16, vertikal: 1.05

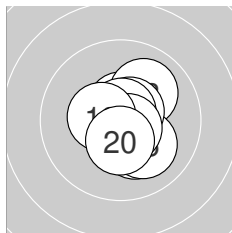

Serie 2: 104.5 (100)

10.6* ↘	10.6* ↑	10.0 ↗	10.2* ↘	10.1 ↘
10.6* ↗	10.8* ↑	10.7* ↘	10.5* ←	10.4* ↓

beste Teiler: 50.6 (17.), 68.6 (18.), 82.7 (16.)
 Trefferlage: 0.43 mm rechts, 0.18 mm tief
 Streuwert: 0.99, horizontal: 0.80, vertikal: 1.16

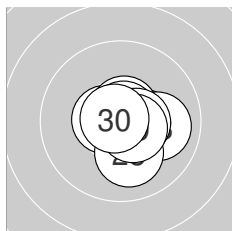

Serie 3: 105.1 (100)

10.6* →	10.4* →	10.0 →	10.6* ←	10.7* ↑
10.8* ↑	10.5* →	10.1 ↓	10.6* →	10.8* ↖

beste Teiler: 41.5 (26.), 43.4 (30.), 73.6 (25.)
 Trefferlage: 0.61 mm rechts, 0.20 mm tief
 Streuwert: 0.84, horizontal: 0.93, vertikal: 0.74

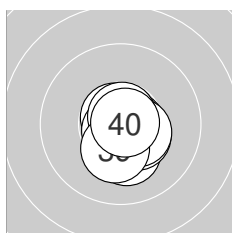

Serie 4: 105.7 (100)

10.2* ↓	10.7* →	10.6* ↓	10.7* ↖	10.4* ↘
10.7* ↙	10.5* ↘	10.8* ↑	10.3* ↓	10.8* →

beste Teiler: 30.6 (40.), 49.8 (38.), 51.6 (36.)
 Trefferlage: 0.24 mm rechts, 0.51 mm tief
 Streuwert: 0.68, horizontal: 0.56, vertikal: 0.78



Ergebnis: **412.6** (394)
 Serien: 103.9 103.7 102.7 102.3
 Zähler: 35 4 1 0 0 0 0 0 0 0
 Innenzehner: 30
 Weitester: 679 (36.), 437 (21.), 421 (24.)
 beste Teiler: 6.4 (40.), 17.8 (5.), 19.6 (20.)
 Trefferlage: 0.13 mm links, 0.01 mm tief
 Streuwert: 1.49, horizontal: 1.91, vertikal: 0.88

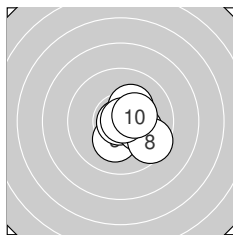
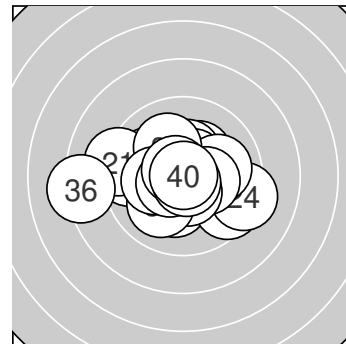

Serie 1: 103.9 (99)

10.7* →	10.4* →	10.2* ↓	10.5* →	10.9* ↙
10.1 →	10.3* ↗	9.6 ↘	10.8* →	10.4* →

beste Teiler: 17.8 (5.), 26.5 (9.), 71.4 (1.)
 Trefferlage: 0.97 mm rechts, 0.19 mm tief
 Streuwert: 1.02, horizontal: 1.00, vertikal: 1.04

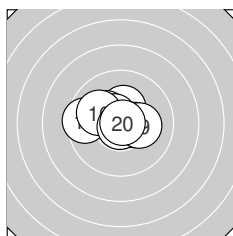

Serie 2: 103.7 (99)

10.3* ↑	10.8* ↖	10.2* ↖	9.5 ←	10.6* ↖
10.0 ↖	10.4* →	10.8* ↓	10.2* →	10.9* →

beste Teiler: 19.6 (20.), 33.1 (12.), 36.1 (18.)
 Trefferlage: 0.45 mm links, 0.39 mm hoch
 Streuwert: 1.21, horizontal: 1.59, vertikal: 0.62

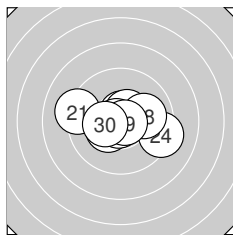

Serie 3: 102.7 (98)

9.2 ←	10.6* ↑	10.5* ↗	9.3 →	10.8* ←
10.4* ↙	10.8* ↓	10.0 →	10.8* →	10.3* ←

beste Teiler: 42.0 (25.), 43.6 (29.), 47.8 (27.)
 Trefferlage: 0.02 mm links, 0.00 mm
 Streuwert: 1.66, horizontal: 2.22, vertikal: 0.77

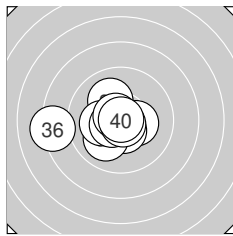

Serie 4: 102.3 (98)

10.3* →	10.1 ↖	10.5* ↓	10.0 ↙	10.2* ←
8.2 ←	10.6* ↙	10.7* ↖	10.8* ↘	10.9* ↗

beste Teiler: 6.4 (40.), 47.5 (39.), 64.5 (38.)
 Trefferlage: 1.02 mm links, 0.27 mm tief
 Streuwert: 1.72, horizontal: 2.23, vertikal: 0.98



Ergebnis: 418.2 (397)
Serien: 103.5 106.3 103.4 105.0
Zähler: 37 3 0 0 0 0 0 0 0 0 0
Innenzehner: 34
Weiteste: 312 (8.), 310 (4.), 286 (30.)
beste Teiler: 4.1 (40.), 13.8 (16.), 14.2 (33.)
Trefferlage: 0.11 mm rechts, 0.03 mm tief
Streuwert: 1.04, horizontal: 1.07, vertikal: 1.01

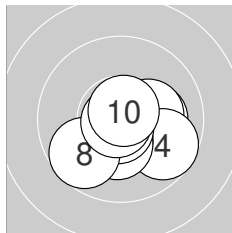
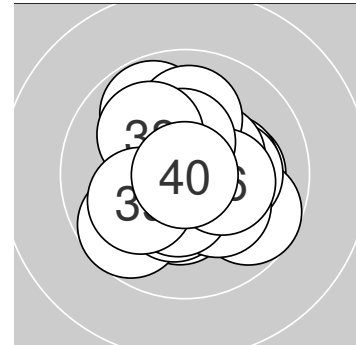

Serie 1: 103.5 (98)

10.8* ↗	10.2* →	10.2* →	9.7 ↘	10.4* ↓
10.3* ↓	10.7* ↓	9.7 ↙	10.8* ↖	10.7* ↑

beste Teiler: 28.1 (1.), 32.4 (9.), 56.3 (10.)
Trefferlage: 0.37 mm rechts, 0.63 mm tief
Streuwert: 1.21, horizontal: 1.42, vertikal: 0.94

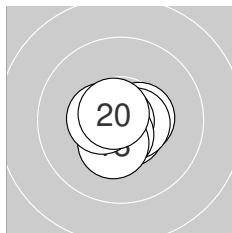

Serie 2: 106.3 (100)

10.5* →	10.6* ↘	10.8* ←	10.6* →	10.8* ↖
10.9* ↙	10.6* ↓	10.3* ↓	10.5* ←	10.7* ↘

beste Teiler: 13.8 (16.), 39.4 (13.), 49.1 (15.)
Trefferlage: 0.06 mm links, 0.25 mm tief
Streuwert: 0.65, horizontal: 0.71, vertikal: 0.59

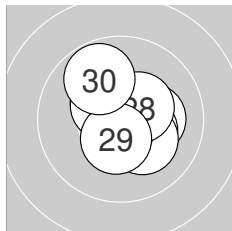

Serie 3: 103.4 (99)

10.6* →	10.2* →	10.7* ↑	10.3* ↘	10.4* ↖
10.4* ↖	10.2* ↘	10.4* ↗	10.4* ↓	9.8 ↖

beste Teiler: 56.0 (23.), 86.1 (21.), 126.3 (29.)
Trefferlage: 0.29 mm rechts, 0.27 mm hoch
Streuwert: 1.16, horizontal: 1.16, vertikal: 1.16

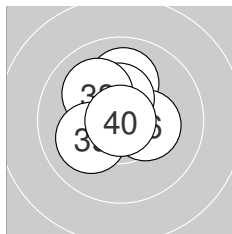

Serie 4: 105.0 (100)

10.7* ↗	10.8* ↖	10.9* ↗	10.8* ↑	10.0 ↑
10.3* →	10.4* ↑	10.1 ↘	10.1 ↖	10.9* ↓

beste Teiler: 4.1 (40.), 14.2 (33.), 27.5 (32.)
Trefferlage: 0.13 mm links, 0.47 mm hoch
Streuwert: 0.99, horizontal: 0.96, vertikal: 1.02

