

Ergebnis: **397** (414.4)
 Serien: 99 100 99 99 20
 Zähler: 39 3 0 0 0 0 0 0 0 0
 Innenzehner: 32
 weiteste: 343 (27), 304 (5), 283 (31)
 beste Teiler 48.3 (10.) 52.0 (28.) 64.5 (17.)
 Trefferlage 0.65 mm rechts, 0.28 mm tief
 Streuwert 1.06, horizontal: 1.13, vertikal: 0.99

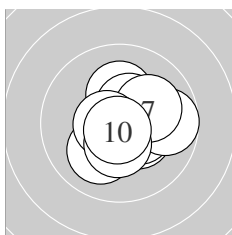

Serie 1:
 10.1 ↙ 10.2 * 10.4 * 10.4 * 9.7 →
 10.5 * 10.1 ↗ 10.6 * 10.4 * 10.8 *
 beste Teiler 48.3 (10.) 85.3 (8.) 124.1 (6.)
 Trefferlage 0.56 mm rechts, 0.09 mm tief
 Streuwert 1.23, horizontal: 1.31, vertikal: 1.14

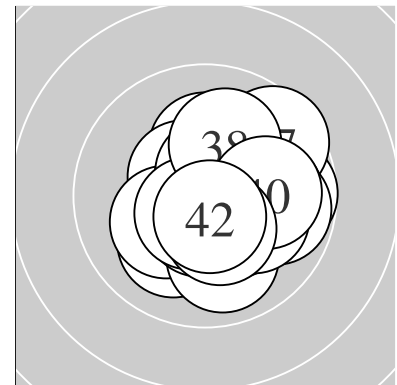
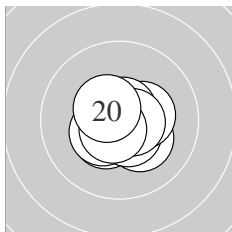

Serie 2:
 10.6 * 10.2 * 10.4 * 10.5 * 10.4 *
 10.4 * 10.7 * 10.6 * 10.7 * 10.5 *
 beste Teiler 64.5 (17.) 75.8 (19.) 80.2 (18.)
 Trefferlage 0.16 mm rechts, 0.36 mm tief
 Streuwert 0.83, horizontal: 0.94, vertikal: 0.71

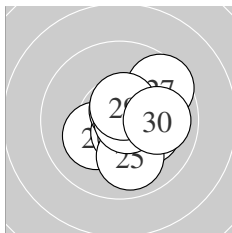

Serie 3:
 10.2 * 10.6 * 10.4 * 10.2 * 10.0 ↓
 10.7 * 9.6 ↗ 10.7 * 10.6 * 10.0 →
 beste Teiler 52.0 (28.) 69.5 (26.) 87.4 (22.)
 Trefferlage 0.83 mm rechts, 0.23 mm tief
 Streuwert 1.26, horizontal: 1.25, vertikal: 1.27

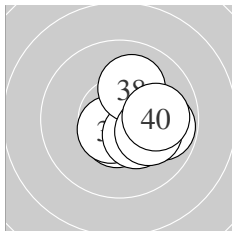

Serie 4:
 9.8 → 10.6 * 10.5 * 10.5 * 10.7 *
 10.6 * 10.3 * 10.1 ↑ 10.1 ↘ 10.0 →
 beste Teiler 75.9 (35.) 89.4 (36.) 99.6 (32.)
 Trefferlage 1.10 mm rechts, 0.29 mm tief
 Streuwert 0.98, horizontal: 1.05, vertikal: 0.91

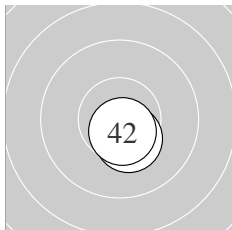

Serie 5:
 10.4 * 10.6 *
 beste Teiler
 Trefferlage 0.39 mm rechts, 1.07 mm tief
 Streuwert 0.32, horizontal: 0.29, vertikal: 0.34

Unterschrift des Schützen

Meyton Elektronik

Ergebnis: **394** (415.2)
 Serien: 98 99 98 99 20
 Zähler: 36 6 0 0 0 0 0 0 0
 Innenzehner: 32
 weiteste: 388 (27), 292 (10), 278 (2)
 beste Teiler 32.6 (9.) 39.3 (30.) 45.4 (40.)
 Trefferlage 0.31 mm rechts, 0.11 mm hoch
 Streuwert 1.14, horizontal: 1.18, vertikal: 1.09

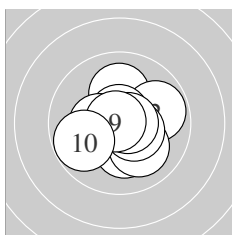
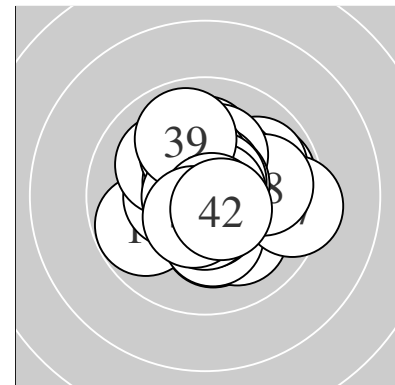

Serie 1:
 10.1 ↑ 9.8 → 10.7 * 10.2 * 10.1 ↘
 10.4 * 10.5 * 10.7 * 10.8 * 9.8 ←
 beste Teiler 32.6 (9.) 60.2 (3.) 61.0 (8.)
 Trefferlage 0.16 mm rechts, 0.16 mm tief
 Streuwert 1.36, horizontal: 1.48, vertikal: 1.24

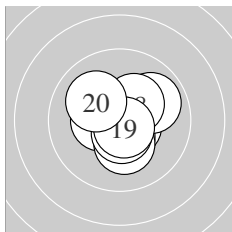

Serie 2:
 10.4 * 10.5 * 10.6 * 10.4 * 10.2 *
 10.6 * 9.9 → 10.3 * 10.7 * 10.1 ↘
 beste Teiler 62.7 (19.) 95.7 (13.) 96.3 (16.)
 Trefferlage 0.27 mm rechts, 0.22 mm tief
 Streuwert 1.14, horizontal: 1.14, vertikal: 1.14

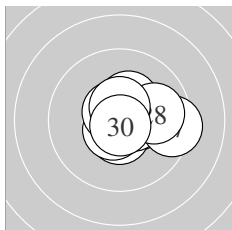

Serie 3:
 10.4 * 10.5 * 10.6 * 10.6 * 10.6 *
 10.3 * 9.4 → 9.9 → 10.6 * 10.8 *
 beste Teiler 39.3 (30.) 79.3 (25.) 84.8 (24.)
 Trefferlage 0.83 mm rechts, 0.08 mm hoch
 Streuwert 1.13, horizontal: 1.41, vertikal: 0.76

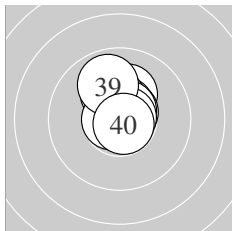

Serie 4:
 10.2 * 10.6 * 10.6 * 10.1 ↑ 10.4 *
 10.6 * 10.7 * 10.8 * 9.9 ↑ 10.8 *
 beste Teiler 45.4 (40.) 47.8 (38.) 56.0 (37.)
 Trefferlage 0.02 mm rechts, 0.94 mm hoch
 Streuwert 0.78, horizontal: 0.56, vertikal: 0.94

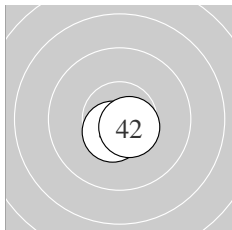

Serie 5:
 10.5 * 10.6 *
 beste Teiler
 Trefferlage 0.10 mm rechts, 0.76 mm tief
 Streuwert 0.63, horizontal: 0.86, vertikal: 0.24

Unterschrift des Schützen

Meyton Elektronik

Ergebnis: **385** (404.7)
 Serien: 94 98 96 97 20
 Zähler: 28 13 1 0 0 0 0 0 0
 Innenzehner: 21
 weiteste: 536 (2), 454 (15), 372 (7)
 beste Teiler 41.6 (24.) 48.3 (16.) 53.4 (36.)
 Trefferlage 0.42 mm links, 0.16 mm hoch
 Streuwert 1.63, horizontal: 1.80, vertikal: 1.44

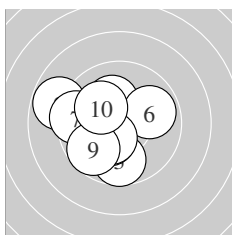
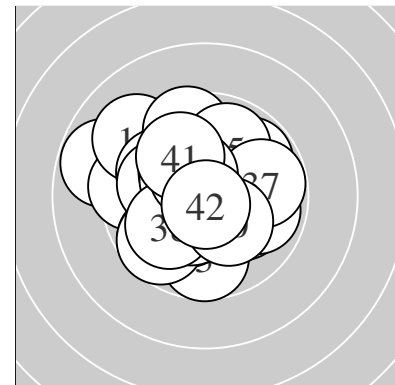

Serie 1:
 10.4 * 8.8 ↖ 9.7 ↓ 10.3 * 10.2 *
 9.9 → 9.5 ← 10.4 * 9.7 ↙ 10.1 ↖
 beste Teiler 146.2 (8.) 146.3 (1.) 162.8 (4.)
 Trefferlage 1.34 mm links, 0.07 mm tief
 Streuwert 1.91, horizontal: 2.06, vertikal: 1.75

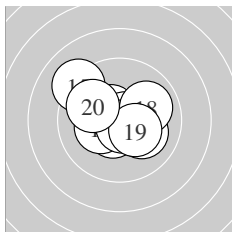

Serie 2:
 10.1 ↘ 10.5 * 10.3 * 10.5 * 9.1 ↖
 10.8 * 10.7 * 10.0 → 10.3 * 9.9 ↖
 beste Teiler 48.3 (16.) 58.6 (17.) 106.0 (14.)
 Trefferlage 0.25 mm links, 0.21 mm hoch
 Streuwert 1.58, horizontal: 1.84, vertikal: 1.27

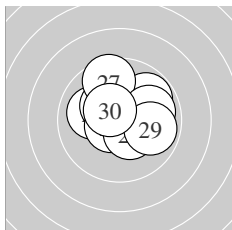

Serie 3:
 10.0 ↖ 10.3 * 10.6 * 10.8 * 10.4 *
 9.8 ↗ 9.6 ↖ 9.9 → 9.9 → 10.5 *
 beste Teiler 41.6 (24.) 88.4 (23.) 118.1 (30.)
 Trefferlage 0.27 mm rechts, 0.63 mm hoch
 Streuwert 1.52, horizontal: 1.71, vertikal: 1.29

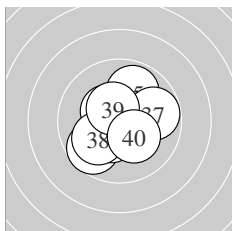

Serie 4:
 9.7 ↙ 10.1 ↙ 10.4 * 10.4 * 9.9 ↗
 10.7 * 9.8 → 10.0 ↙ 10.5 * 10.2 *
 beste Teiler 53.4 (36.) 120.8 (39.) 136.2 (33.)
 Trefferlage 0.33 mm links, 0.24 mm tief
 Streuwert 1.54, horizontal: 1.59, vertikal: 1.48

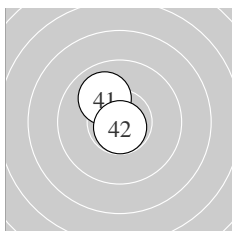

Serie 5:
 10.0 ↖ 10.8 *
 beste Teiler
 Trefferlage 0.61 mm links, 0.78 mm hoch
 Streuwert 1.38, horizontal: 0.92, vertikal: 1.73

Unterschrift des Schützen

Meyton Elektronik

Ergebnis: **391** (410.1)
 Serien: 98 98 98 97 20
 Zähler: 33 9 0 0 0 0 0 0 0
 Innenzehner: 27
 weiteste: 408 (32), 313 (24), 302 (6)
 beste Teiler 38.3 (30.) 42.9 (9.) 51.9 (17.)
 Trefferlage 0.37 mm rechts, 0.40 mm hoch
 Streuwert 1.31, horizontal: 1.36, vertikal: 1.24

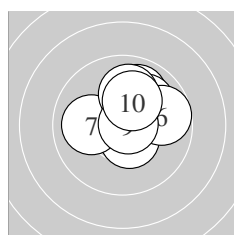
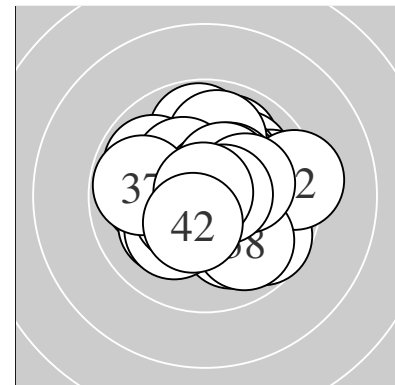

Serie 1:
 9.9 ↗ 10.0 ↗ 10.5 * 10.5 * 10.3 *
 9.7 → 10.0 ← 10.0 ↑ 10.8 * 10.2 *
 beste Teiler 42.9 (9.) 102.5 (4.) 112.7 (3.)
 Trefferlage 0.60 mm rechts, 1.05 mm hoch
 Streuwert 1.21, horizontal: 1.33, vertikal: 1.09

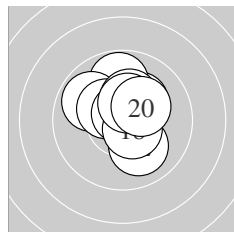

Serie 2:
 10.2 * 10.0 ↘ 9.8 ↑ 9.9 ↖ 10.4 *
 10.3 * 10.7 * 10.6 * 10.4 * 10.3 *
 beste Teiler 51.9 (17.) 98.4 (18.) 133.5 (19.)
 Trefferlage 0.14 mm rechts, 0.82 mm hoch
 Streuwert 1.24, horizontal: 1.18, vertikal: 1.31

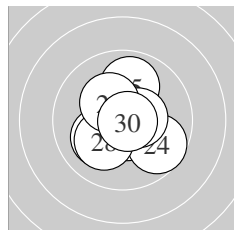

Serie 3:
 10.5 * 10.6 * 10.6 * 9.7 ↘ 9.9 ↑
 10.5 * 10.1 ↙ 10.1 ↙ 10.3 * 10.8 *
 beste Teiler 38.3 (30.) 86.9 (22.) 96.0 (23.)
 Trefferlage 0.25 mm rechts, 0.20 mm tief
 Streuwert 1.31, horizontal: 1.29, vertikal: 1.33

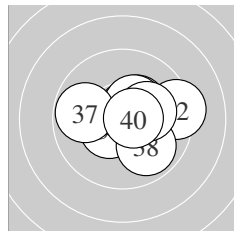

Serie 4:
 10.4 * 9.3 → 10.7 * 10.5 * 10.7 *
 10.4 * 9.8 ← 9.9 ↘ 10.2 * 10.6 *
 beste Teiler 66.3 (35.) 73.7 (33.) 81.3 (40.)
 Trefferlage 0.64 mm rechts, 0.12 mm hoch
 Streuwert 1.46, horizontal: 1.83, vertikal: 0.97

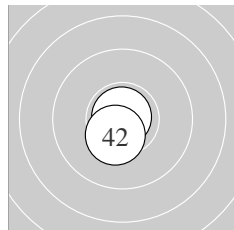

Serie 5:
 10.9 * 10.4 *
 beste Teiler
 Trefferlage 0.31 mm links, 0.52 mm tief
 Streuwert 0.72, horizontal: 0.33, vertikal: 0.97

Unterschrift des Schützen

Meyton Elektronik

Ergebnis: **386** (404.5)
 Serien: 95 97 97 97 20
 Zähler: 28 14 0 0 0 0 0 0 0
 Innenzehner: 21
 weiteste: 422 (13), 418 (7), 372 (3)
 beste Teiler 35.7 (18.) 53.4 (33.) 71.3 (11.)
 Trefferlage 0.41 mm links, 0.00 mm
 Streuwert 1.61, horizontal: 1.42, vertikal: 1.77

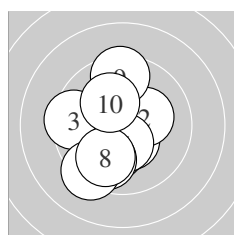
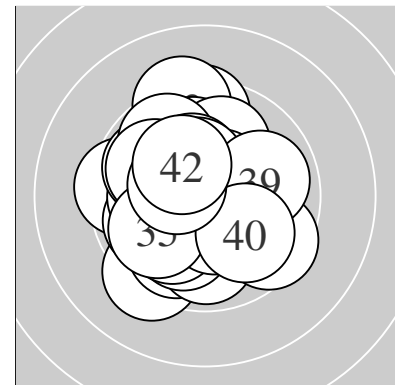

Serie 1:
 10.4 * 10.3 * 9.5 ← 10.2 * 10.4 *
 9.8 ↘ 9.3 ↙ 9.9 ↙ 9.5 ↑ 10.2 *
 beste Teiler 127.9 (1.) 135.3 (5.) 175.6 (2.)
 Trefferlage 0.80 mm links, 0.63 mm tief
 Streuwert 1.90, horizontal: 1.51, vertikal: 2.22

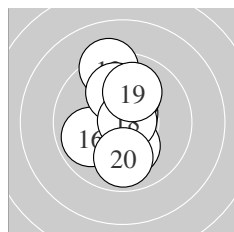

Serie 2:
 10.7 * 10.6 * 9.3 ↑ 10.2 * 10.1 ↑
 9.9 ← 10.0 ↑ 10.8 * 10.0 ↑ 9.9 ↓
 beste Teiler 35.7 (18.) 71.3 (11.) 76.5 (12.)
 Trefferlage 0.11 mm links, 0.64 mm hoch
 Streuwert 1.63, horizontal: 0.98, vertikal: 2.09

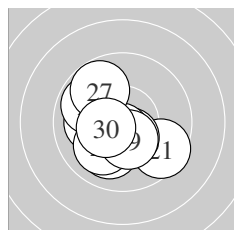

Serie 3:
 9.5 ↘ 10.1 ← 10.4 * 10.6 * 10.0 ↘
 9.9 ↘ 9.8 ↘ 10.0 ↙ 10.4 * 10.4 *
 beste Teiler 81.2 (24.) 126.2 (23.) 133.1 (30.)
 Trefferlage 0.64 mm links, 0.58 mm tief
 Streuwert 1.54, horizontal: 1.61, vertikal: 1.46

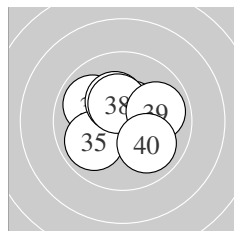

Serie 4:
 10.6 * 10.5 * 10.7 * 9.9 ↘ 9.9 ↙
 10.3 * 10.2 * 10.4 * 9.9 → 10.0 ↘
 beste Teiler 53.4 (33.) 78.1 (31.) 103.5 (32.)
 Trefferlage 0.05 mm rechts, 0.34 mm hoch
 Streuwert 1.40, horizontal: 1.64, vertikal: 1.10

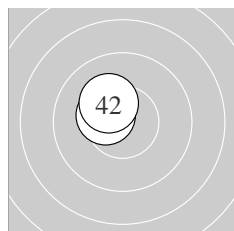

Serie 5:
 10.4 * 10.2 *
 beste Teiler
 Trefferlage 1.16 mm links, 0.96 mm hoch
 Streuwert 0.47, horizontal: 0.16, vertikal: 0.64

Unterschrift des Schützen

Meyton Elektronik

Ergebnis: **394** (413.6)
 Serien: 99 98 98 99 19
 Zähler: 35 7 0 0 0 0 0 0 0 0
 Innenzehner: 29
 weiteste: 394 (39), 375 (19), 322 (29)
 beste Teiler 10.0 (5.) 31.1 (14.) 40.7 (18.)
 Trefferlage 0.15 mm rechts, 0.25 mm hoch
 Streuwert 1.27, horizontal: 1.31, vertikal: 1.24

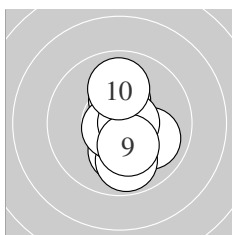
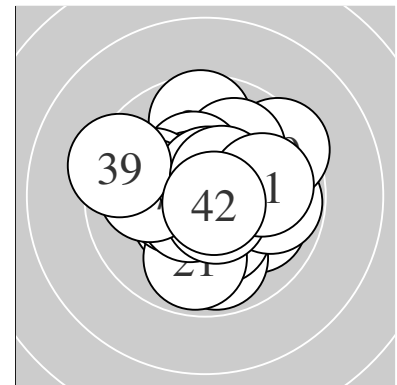

Serie 1:
 10.3 * 10.0 ↘ 10.2 * 9.9 ↓ 10.9 *
 10.7 * 10.7 * 10.7 * 10.3 * 10.0 ↑
 beste Teiler 10.0 (5.) 61.8 (7.) 65.0 (8.)
 Trefferlage 0.32 mm rechts, 0.43 mm tief
 Streuwert 1.24, horizontal: 0.75, vertikal: 1.59

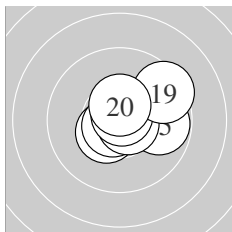

Serie 2:
 10.4 * 10.1 → 10.4 * 10.8 * 9.8 →
 10.7 * 10.7 * 10.8 * 9.5 ↗ 10.5 *
 beste Teiler 31.1 (14.) 40.7 (18.) 65.2 (16.)
 Trefferlage 0.84 mm rechts, 0.21 mm hoch
 Streuwert 1.18, horizontal: 1.44, vertikal: 0.85

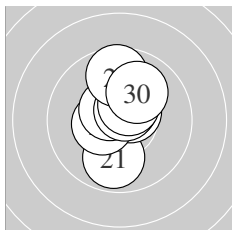

Serie 3:
 9.9 ↓ 10.5 * 10.6 * 10.4 * 10.5 *
 10.5 * 10.6 * 10.4 * 9.7 ↑ 10.0 ↗
 beste Teiler 81.8 (27.) 99.2 (23.) 104.0 (25.)
 Trefferlage 0.15 mm rechts, 0.74 mm hoch
 Streuwert 1.21, horizontal: 0.77, vertikal: 1.52

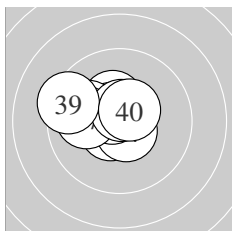

Serie 4:
 10.4 * 10.4 * 10.6 * 10.6 * 10.6 *
 10.0 ← 10.0 ← 10.6 * 9.4 ↖ 10.5 *
 beste Teiler 78.0 (38.) 78.5 (35.) 84.8 (34.)
 Trefferlage 0.96 mm links, 0.54 mm hoch
 Streuwert 1.12, horizontal: 1.42, vertikal: 0.72

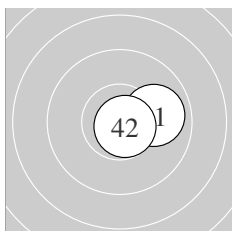

Serie 5:
 9.9 → 10.8 *
 beste Teiler
 Trefferlage 1.43 mm rechts, 0.08 mm hoch
 Streuwert 1.12, horizontal: 1.48, vertikal: 0.57

Unterschrift des Schützen

Meyton Elektronik

Ergebnis: **389** (407.3)
 Serien: 99 97 99 94 20
 Zähler: 32 9 1 0 0 0 0 0 0
 Innenzehner: 28
 weiteste: 515 (34), 455 (28), 409 (20)
 beste Teiler 9.8 (37.) 33.2 (26.) 42.4 (25.)
 Trefferlage 0.15 mm links, 0.23 mm tief
 Streuwert 1.58, horizontal: 1.91, vertikal: 1.17

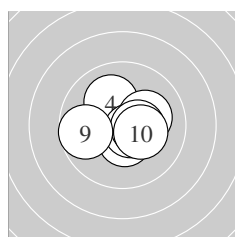
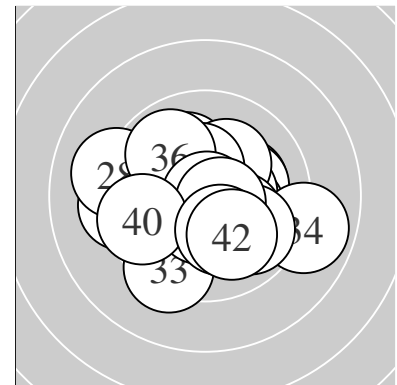

Serie 1:
 10.4 * 10.6 * 10.6 * 10.1 ↖ 10.5 *
 10.6 * 10.2 * 10.5 * 9.7 ← 10.3 *
 beste Teiler 79.0 (6.) 80.0 (3.) 93.5 (2.)
 Trefferlage 0.41 mm rechts, 0.08 mm tief
 Streuwert 1.21, horizontal: 1.47, vertikal: 0.88

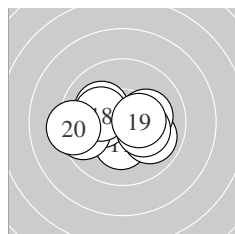

Serie 2:
 10.3 * 10.1 ↖ 9.9 ↘ 10.2 * 9.6 ←
 10.2 * 10.2 * 10.2 * 10.4 * 9.3 ←
 beste Teiler 135.6 (19.) 168.5 (11.) 176.4 (14.)
 Trefferlage 0.54 mm links, 0.22 mm tief
 Streuwert 1.73, horizontal: 2.29, vertikal: 0.89

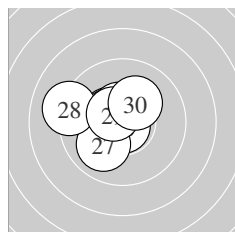

Serie 3:
 10.4 * 10.4 * 10.5 * 10.5 * 10.8 *
 10.8 * 10.0 ↙ 9.1 ← 10.5 * 10.2 *
 beste Teiler 33.2 (26.) 42.4 (25.) 101.3 (29.)
 Trefferlage 0.98 mm links, 0.38 mm hoch
 Streuwert 1.21, horizontal: 1.43, vertikal: 0.95

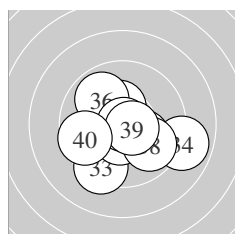

Serie 4:
 10.2 * 10.4 * 9.4 ↙ 8.9 → 10.5 *
 9.9 ↘ 10.9 * 9.8 ↘ 10.6 * 9.6 ←
 beste Teiler 9.8 (37.) 83.7 (39.) 117.0 (35.)
 Trefferlage 0.24 mm rechts, 0.70 mm tief
 Streuwert 1.98, horizontal: 2.30, vertikal: 1.60

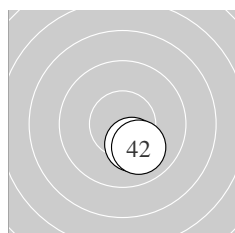

Serie 5:
 10.2 * 10.0 ↘
 beste Teiler
 Trefferlage 1.04 mm rechts, 1.80 mm tief
 Streuwert 0.31, horizontal: 0.40, vertikal: 0.16

Unterschrift des Schützen

Meyton Elektronik

Ergebnis: **382** (398.9)
 Serien: 94 96 98 94 19
 Zähler: 23 19 0 0 0 0 0 0 0
 Innenzehner: 20
 weiteste: 497 (17), 495 (4), 406 (40)
 beste Teiler 42.1 (30.) 84.0 (23.) 85.0 (11.)
 Trefferlage 0.25 mm links, 0.33 mm tief
 Streuwert 1.94, horizontal: 2.02, vertikal: 1.85

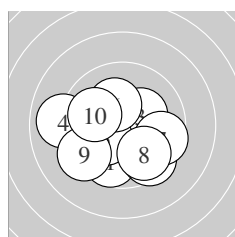
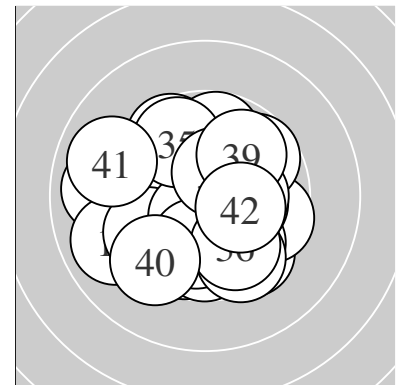

Serie 1:
 9.7 ↓ 9.5 ↘ 10.3 * 9.0 ← 10.2 *
 10.2 * 9.6 → 9.8 ↘ 9.4 ↙ 10.0 ↖
 beste Teiler 173.7 (3.) 178.2 (5.) 181.4 (6.)
 Trefferlage 0.48 mm links, 0.88 mm tief
 Streuwert 2.22, horizontal: 2.62, vertikal: 1.72

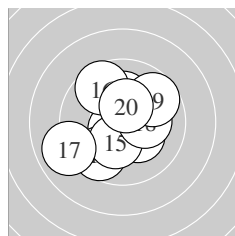

Serie 2:
 10.6 * 10.3 * 9.7 ↙ 10.2 * 10.3 *
 9.6 ↘ 9.0 ← 10.2 * 9.7 ↗ 10.4 *
 beste Teiler 85.0 (11.) 139.0 (20.) 170.0 (12.)
 Trefferlage 0.33 mm links, 0.00 mm
 Streuwert 1.99, horizontal: 2.04, vertikal: 1.92

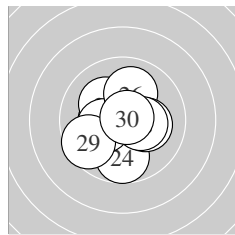

Serie 3:
 10.4 * 10.2 * 10.6 * 9.7 ↓ 10.3 *
 10.0 ↑ 10.2 * 10.3 * 9.6 ↙ 10.8 *
 beste Teiler 42.1 (30.) 84.0 (23.) 147.1 (21.)
 Trefferlage 0.28 mm links, 0.31 mm tief
 Streuwert 1.48, horizontal: 1.50, vertikal: 1.46

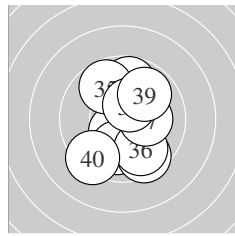

Serie 4:
 10.5 * 9.8 ↑ 10.0 ↓ 9.5 ↘ 9.7 ↘
 9.8 ↘ 10.2 * 10.4 * 9.9 ↗ 9.3 ↙
 beste Teiler 118.7 (31.) 131.4 (38.) 193.0 (37.)
 Trefferlage 0.32 mm rechts, 0.32 mm tief
 Streuwert 2.02, horizontal: 1.52, vertikal: 2.42

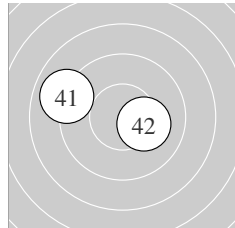

Serie 5:
 9.0 ↖ 10.2 *
 beste Teiler
 Trefferlage 1.44 mm links, 0.57 mm hoch
 Streuwert 3.41, horizontal: 4.54, vertikal: 1.63

Unterschrift des Schützen

Meyton Elektronik

Ergebnis: **391** (412.6)
 Serien: 96 98 99 98
 Zähler: 31 9 0 0 0 0 0 0 0 0
 Innenzehner: 27
 weiteste: 411 (10), 343 (35), 277 (38)
 beste Teiler 21.9 (27.) 31.1 (2.) 35.5 (23.)
 Trefferlage 0.05 mm rechts, 0.27 mm hoch
 Streuwert 1.31, horizontal: 1.20, vertikal: 1.42

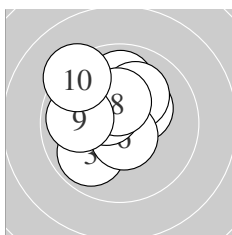
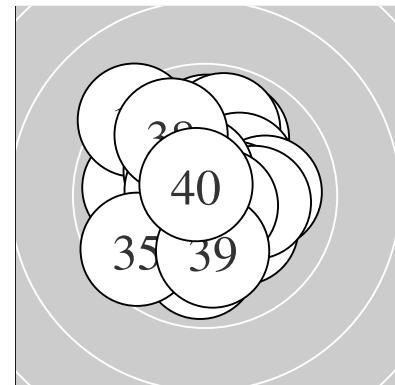

Serie 1:
 9.9 ↑ 10.8 * 9.9 ↙ 10.3 * 10.1 ↗
 10.6 * 10.5 * 10.4 * 9.9 ← 9.3 ↘
 beste Teiler 31.1 (2.) 89.8 (6.) 116.8 (7.)
 Trefferlage 0.58 mm links, 0.83 mm hoch
 Streuwert 1.47, horizontal: 1.44, vertikal: 1.50

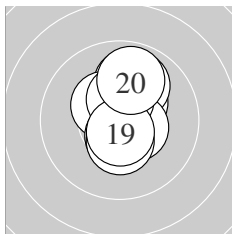

Serie 2:
 10.0 ↑ 10.4 * 9.9 ↗ 10.4 * 10.5 *
 10.4 * 10.5 * 10.4 * 10.6 * 9.9 ↑
 beste Teiler 79.1 (19.) 105.1 (17.) 110.9 (15.)
 Trefferlage 0.33 mm rechts, 0.71 mm hoch
 Streuwert 1.17, horizontal: 0.65, vertikal: 1.53

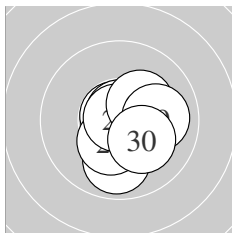

Serie 3:
 10.8 * 10.3 * 10.8 * 10.8 * 9.9 ↓
 10.4 * 10.9 * 10.3 * 10.0 → 10.2 *
 beste Teiler 21.9 (27.) 35.5 (23.) 42.0 (24.)
 Trefferlage 0.57 mm rechts, 0.29 mm tief
 Streuwert 1.07, horizontal: 1.03, vertikal: 1.12

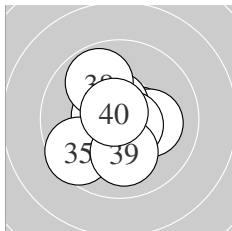

Serie 4:
 10.5 * 10.2 * 10.6 * 10.6 * 9.6 ↙
 10.7 * 10.7 * 9.8 ↘ 10.1 ↓ 10.7 *
 beste Teiler 57.6 (40.) 73.1 (36.) 75.2 (37.)
 Trefferlage 0.10 mm links, 0.14 mm tief
 Streuwert 1.35, horizontal: 1.34, vertikal: 1.35

Unterschrift des Schützen

Meyton Elektronik

Ergebnis: **397** (414.9)
 Serien: 100 99 99 99
 Zähler: 37 3 0 0 0 0 0 0 0 0
 Innenzehner: 31
 weiteste: 347 (39), 291 (22), 261 (20)
 beste Teiler 39.3 (10.) 54.5 (29.) 60.8 (26.)
 Trefferlage 0.09 mm links, 0.03 mm hoch
 Streuwert 1.15, horizontal: 1.12, vertikal: 1.19

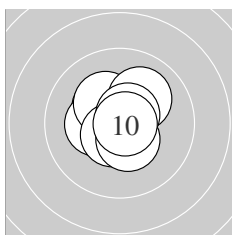
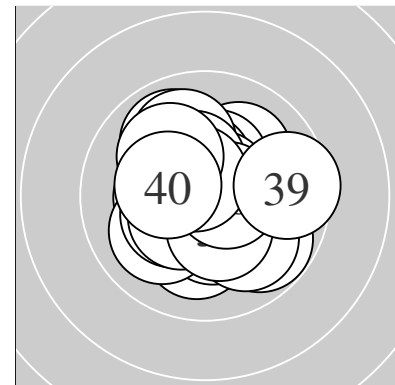

Serie 1:
 10.3 * 10.5 * 10.7 * 10.3 * 10.3 *
 10.6 * 10.1 ↗ 10.4 * 10.6 * 10.8 *
 beste Teiler 39.3 (10.) 69.6 (3.) 80.6 (9.)
 Trefferlage 0.18 mm links, 0.28 mm hoch
 Streuwert 0.97, horizontal: 0.97, vertikal: 0.96

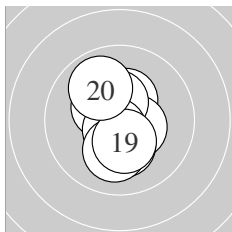

Serie 2:
 10.6 * 10.4 * 10.4 * 10.5 * 10.2 *
 10.4 * 10.6 * 10.1 ↓ 10.3 * 9.9 ↘
 beste Teiler 76.0 (17.) 99.6 (11.) 118.1 (14.)
 Trefferlage 0.14 mm links, 0.03 mm hoch
 Streuwert 1.19, horizontal: 0.73, vertikal: 1.52

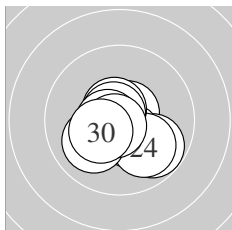

Serie 3:
 10.7 * 9.8 ↘ 10.5 * 10.0 ↘ 10.6 *
 10.7 * 10.0 ↙ 10.6 * 10.7 * 10.3 *
 beste Teiler 54.5 (29.) 60.8 (26.) 74.2 (21.)
 Trefferlage 0.00 mm , 0.56 mm tief
 Streuwert 1.13, horizontal: 1.29, vertikal: 0.95

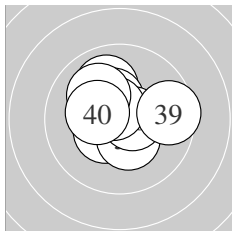

Serie 4:
 10.6 * 10.4 * 10.4 * 10.0 ↗ 10.4 *
 10.6 * 10.6 * 10.1 ↘ 9.6 → 10.3 *
 beste Teiler 86.4 (37.) 90.0 (36.) 99.1 (31.)
 Trefferlage 0.05 mm links, 0.38 mm hoch
 Streuwert 1.34, horizontal: 1.49, vertikal: 1.17

Unterschrift des Schützen

Meyton Elektronik

Ergebnis: **390** (408.0)
 Serien: 98 99 94 99
 Zähler: 30 10 0 0 0 0 0 0 0 0
 Innenzehner: 23
 weiteste: 339 (10), 337 (28), 313 (22)
 beste Teiler 29.8 (23.) 33.1 (3.) 51.3 (34.)
 Trefferlage 0.28 mm links, 0.14 mm tief
 Streuwert 1.45, horizontal: 1.43, vertikal: 1.47

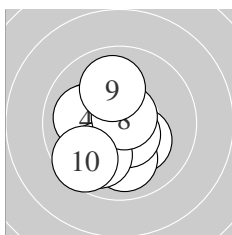
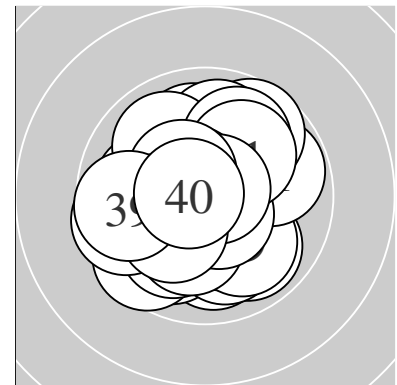

Serie 1:
 10.3 * 10.2 * 10.8 * 10.0 ← 10.0 ↓
 10.6 * 9.9 ↙ 10.7 * 10.0 ↑ 9.6 ↘
 beste Teiler 33.1 (3.) 53.6 (8.) 94.8 (6.)
 Trefferlage 0.58 mm links, 0.55 mm tief
 Streuwert 1.43, horizontal: 1.30, vertikal: 1.55

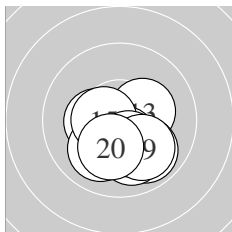

Serie 2:
 10.3 * 10.0 ↘ 10.3 * 10.4 * 10.5 *
 9.9 ↘ 10.0 ↓ 10.3 * 10.0 ↘ 10.2 *
 beste Teiler 107.0 (15.) 132.4 (14.) 156.2 (11.)
 Trefferlage 0.19 mm rechts, 1.22 mm tief
 Streuwert 1.14, horizontal: 1.25, vertikal: 1.01

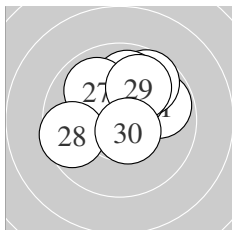

Serie 3:
 9.8 → 9.7 ↗ 10.8 * 10.2 * 10.2 *
 9.9 ↑ 9.9 ↘ 9.6 ← 9.9 ↗ 10.6 *
 beste Teiler 29.8 (23.) 93.4 (30.) 182.5 (24.)
 Trefferlage 0.15 mm rechts, 1.17 mm hoch
 Streuwert 1.55, horizontal: 1.76, vertikal: 1.31

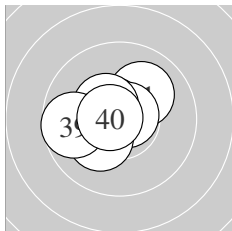

Serie 4:
 10.1 ↗ 10.4 * 10.6 * 10.7 * 10.4 *
 10.3 * 10.3 * 10.2 * 9.7 ← 10.7 *
 beste Teiler 51.3 (34.) 66.7 (40.) 84.3 (33.)
 Trefferlage 0.89 mm links, 0.02 mm hoch
 Streuwert 1.06, horizontal: 1.23, vertikal: 0.87

Unterschrift des Schützen

Meyton Elektronik

Ergebnis: **392** (408.9)
 Serien: 98 97 100 97
 Zähler: 32 8 0 0 0 0 0 0 0 0
 Innenzehner: 25
 weiteste: 312 (34), 310 (17), 303 (31)
 beste Teiler 65.3 (11.) 72.8 (37.) 79.3 (6.)
 Trefferlage 0.42 mm rechts, 0.28 mm hoch
 Streuwert 1.35, horizontal: 1.51, vertikal: 1.18

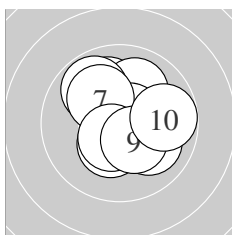
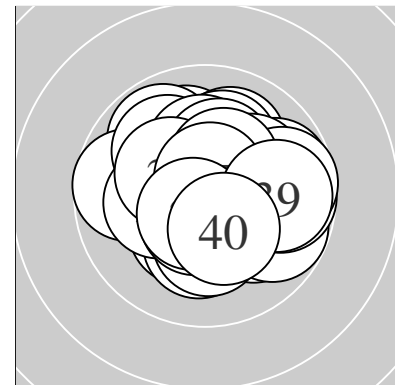

Serie 1:
 10.0 ↖ 10.0 ↗ 9.8 ↘ 10.3 * 10.0 ↘
 10.6 * 10.1 ↘ 10.5 * 10.4 * 9.8 →
 beste Teiler 79.3 (6.) 111.0 (8.) 147.4 (9.)
 Trefferlage 0.26 mm rechts, 0.43 mm hoch
 Streuwert 1.51, horizontal: 1.48, vertikal: 1.53

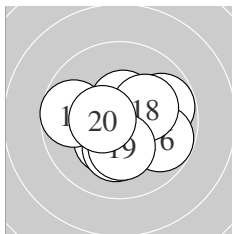

Serie 2:
 10.7 * 10.3 * 9.8 → 10.2 * 10.5 *
 9.8 ↘ 9.7 ← 10.2 * 10.2 * 10.5 *
 beste Teiler 65.3 (11.) 111.4 (15.) 115.1 (20.)
 Trefferlage 0.16 mm rechts, 0.26 mm tief
 Streuwert 1.52, horizontal: 1.81, vertikal: 1.16

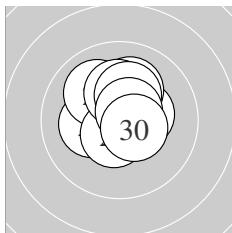

Serie 3:
 10.6 * 10.2 * 10.0 ↘ 10.4 * 10.6 *
 10.1 ↗ 10.2 * 10.3 * 10.6 * 10.5 *
 beste Teiler 85.5 (29.) 85.7 (21.) 100.4 (25.)
 Trefferlage 0.07 mm rechts, 0.73 mm hoch
 Streuwert 1.06, horizontal: 1.05, vertikal: 1.06

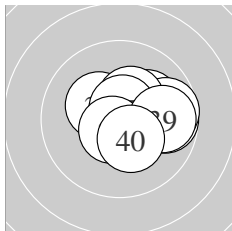

Serie 4:
 9.7 → 10.4 * 10.1 ↗ 9.7 → 10.3 *
 10.4 * 10.7 * 10.6 * 9.8 → 10.3 *
 beste Teiler 72.8 (37.) 87.0 (38.) 137.0 (32.)
 Trefferlage 1.19 mm rechts, 0.23 mm hoch
 Streuwert 1.23, horizontal: 1.53, vertikal: 0.82

Unterschrift des Schützen

Ergebnis: **391** (408.5)
 Serien: 97 97 99 98
 Zähler: 31 9 0 0 0 0 0 0 0 0
 Innenzehner: 25
 weiteste: 380 (13), 362 (40), 358 (1)
 beste Teiler 62.2 (38.) 67.8 (7.) 77.3 (30.)
 Trefferlage 0.08 mm links, 0.49 mm hoch
 Streuwert 1.40, horizontal: 1.30, vertikal: 1.50

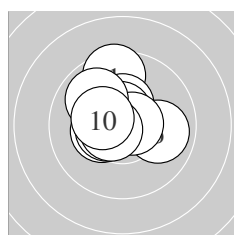
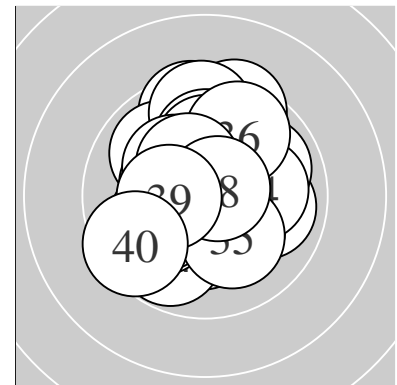

Serie 1:
 9.5 ↑ 10.3 * 10.5 * 10.4 * 10.6 *
 9.9 → 10.7 * 10.6 * 9.9 ↘ 10.3 *
 beste Teiler 67.8 (7.) 87.6 (8.) 88.4 (5.)
 Trefferlage 0.43 mm links, 0.67 mm hoch
 Streuwert 1.29, horizontal: 1.29, vertikal: 1.28

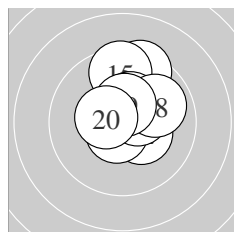

Serie 2:
 10.2 * 10.3 * 9.4 ↑ 10.6 * 9.5 ↑
 10.4 * 10.5 * 9.9 ↗ 10.5 * 10.5 *
 beste Teiler 79.4 (14.) 121.1 (17.) 121.8 (20.)
 Trefferlage 0.64 mm rechts, 1.14 mm hoch
 Streuwert 1.28, horizontal: 1.04, vertikal: 1.48

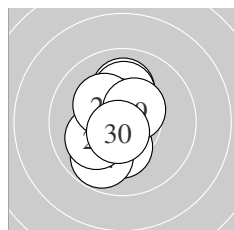

Serie 3:
 10.0 ↑ 10.5 * 10.2 * 9.8 ↙ 10.1 ↑
 10.6 * 10.1 ↖ 10.2 * 10.5 * 10.6 *
 beste Teiler 77.3 (30.) 97.9 (26.) 117.6 (22.)
 Trefferlage 0.57 mm links, 0.17 mm hoch
 Streuwert 1.29, horizontal: 0.84, vertikal: 1.62

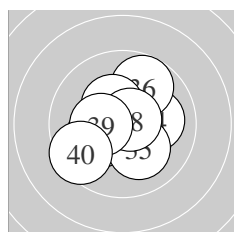

Serie 4:
 10.1 ↖ 10.2 * 10.2 * 10.1 → 10.1 ↘
 9.8 ↗ 10.4 * 10.7 * 10.3 * 9.5 ↙
 beste Teiler 62.2 (38.) 147.7 (37.) 154.1 (39.)
 Trefferlage 0.02 mm rechts, 0.01 mm tief
 Streuwert 1.62, horizontal: 1.69, vertikal: 1.54

Unterschrift des Schützen

Meyton Elektronik

Ergebnis: **392** (412.2)
 Serien: 97 98 98 99
 Zähler: 32 8 0 0 0 0 0 0 0 0
 Innenzehner: 27
 weiteste: 349 (17), 340 (11), 328 (1)
 beste Teiler 18.0 (5.) 40.1 (23.) 49.4 (14.)
 Trefferlage 0.09 mm rechts, 0.39 mm tief
 Streuwert 1.29, horizontal: 1.43, vertikal: 1.14

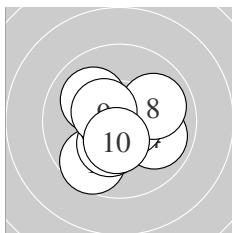
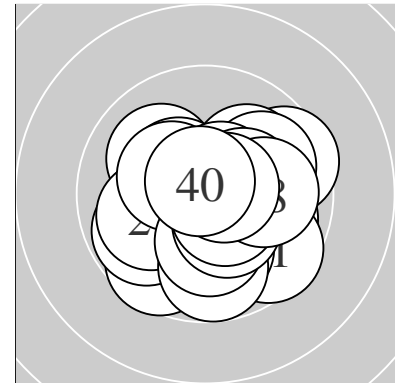

Serie 1:
 9.6 ↙ 10.3 * 10.0 ↘ 9.9 ↘ 10.9 *
 10.7 * 10.8 * 9.9 → 10.5 * 10.4 *
 beste Teiler 18.0 (5.) 50.9 (7.) 75.5 (6.)
 Trefferlage 0.04 mm links, 0.37 mm tief
 Streuwert 1.39, horizontal: 1.49, vertikal: 1.28

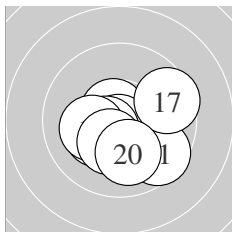

Serie 2:
 9.6 ↘ 10.7 * 10.7 * 10.8 * 10.2 *
 10.5 * 9.6 → 10.2 * 10.3 * 10.0 ↓
 beste Teiler 49.4 (14.) 72.2 (13.) 74.4 (12.)
 Trefferlage 0.03 mm rechts, 0.70 mm tief
 Streuwert 1.42, horizontal: 1.67, vertikal: 1.11

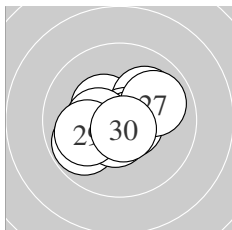

Serie 3:
 10.4 * 10.1 ↗ 10.8 * 9.8 ↙ 10.5 *
 10.6 * 9.9 → 10.4 * 10.0 ← 10.7 *
 beste Teiler 40.1 (23.) 65.3 (30.) 78.5 (26.)
 Trefferlage 0.20 mm links, 0.08 mm tief
 Streuwert 1.31, horizontal: 1.58, vertikal: 0.97

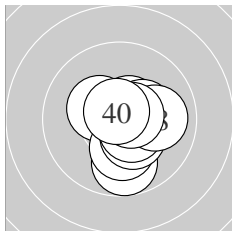

Serie 4:
 10.6 * 10.3 * 9.8 ↓ 10.2 * 10.3 *
 10.4 * 10.5 * 10.0 → 10.6 * 10.7 *
 beste Teiler 56.0 (40.) 82.2 (39.) 95.5 (31.)
 Trefferlage 0.60 mm rechts, 0.40 mm tief
 Streuwert 1.14, horizontal: 1.00, vertikal: 1.26

Unterschrift des Schützen

Ergebnis: **384** (402.2)
 Serien: 99 95 93 97
 Zähler: 26 12 2 0 0 0 0 0 0 0
 Innenzehner: 20
 weiteste: 568 (29), 517 (23), 436 (9)
 beste Teiler 54.0 (22.) 61.2 (25.) 70.3 (36.)
 Trefferlage 0.60 mm links, 0.17 mm hoch
 Streuwert 1.76, horizontal: 1.98, vertikal: 1.51

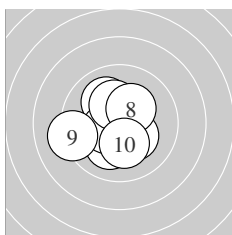
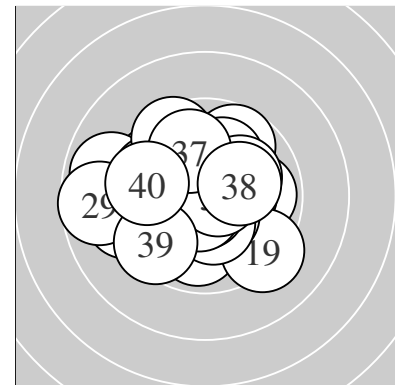

Serie 1:
 10.4 * 10.1 ↖ 10.1 ↗ 10.5 * 10.3 *
 10.5 * 10.3 * 10.3 * 9.2 ← 10.2 *
 beste Teiler 104.3 (6.) 123.1 (4.) 148.5 (1.)
 Trefferlage 0.57 mm links, 0.03 mm hoch
 Streuwert 1.53, horizontal: 1.58, vertikal: 1.47

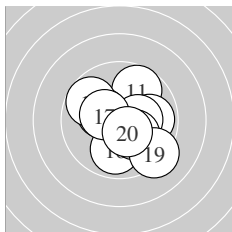

Serie 2:
 9.7 ↗ 9.9 → 10.3 * 10.3 * 9.7 ↖
 9.9 ↓ 10.4 * 10.2 * 9.3 ↘ 10.5 *
 beste Teiler 124.8 (20.) 143.6 (17.) 163.0 (14.)
 Trefferlage 0.51 mm rechts, 0.23 mm tief
 Streuwert 1.83, horizontal: 1.90, vertikal: 1.76

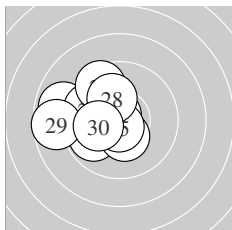

Serie 3:
 9.9 ← 10.7 * 8.9 ← 10.3 * 10.7 *
 9.8 ← 9.5 ↖ 10.1 ↖ 8.7 ← 10.2 *
 beste Teiler 54.0 (22.) 61.2 (25.) 151.8 (24.)
 Trefferlage 2.00 mm links, 0.32 mm hoch
 Streuwert 1.79, horizontal: 2.05, vertikal: 1.48

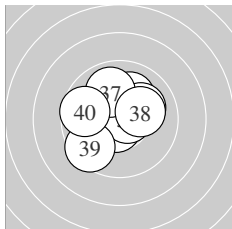

Serie 4:
 10.4 * 10.1 ↖ 10.1 ↗ 10.1 ↗ 10.6 *
 10.7 * 9.9 ↖ 10.2 * 9.5 ↗ 9.7 ←
 beste Teiler 70.3 (36.) 80.2 (35.) 134.1 (31.)
 Trefferlage 0.37 mm links, 0.58 mm hoch
 Streuwert 1.59, horizontal: 1.76, vertikal: 1.40

Unterschrift des Schützen

Meyton Elektronik

Ergebnis: **383** (401.1)
 Serien: 96 96 97 94
 Zähler: 25 13 2 0 0 0 0 0 0 0
 Innenzehner: 19
 weiteste: 557 (37), 538 (27), 474 (8)
 beste Teiler 40.6 (9.) 68.6 (7.) 69.3 (12.)
 Trefferlage 0.42 mm rechts, 0.31 mm tief
 Streuwert 1.85, horizontal: 1.75, vertikal: 1.96

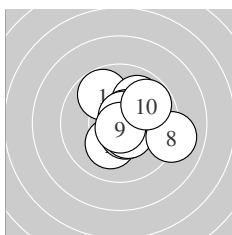
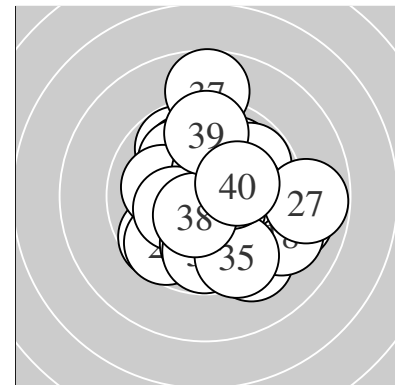

Serie 1:
 9.8 ↖ 10.2 * 9.9 ↗ 10.5 * 10.5 *
 10.6 * 10.7 * 9.1 → 10.8 * 9.8 ↗
 beste Teiler 40.6 (9.) 68.6 (7.) 93.8 (6.)
 Trefferlage 0.84 mm rechts, 0.22 mm hoch
 Streuwert 1.60, horizontal: 1.70, vertikal: 1.49

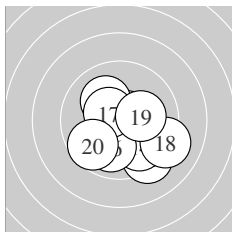

Serie 2:
 9.3 ↘ 10.7 * 10.2 * 9.8 ↘ 10.1 ↖
 10.0 ↓ 10.5 * 9.1 ↘ 10.2 * 9.7 ↙
 beste Teiler 69.3 (12.) 116.4 (17.) 182.9 (13.)
 Trefferlage 0.59 mm rechts, 1.08 mm tief
 Streuwert 1.84, horizontal: 1.97, vertikal: 1.69

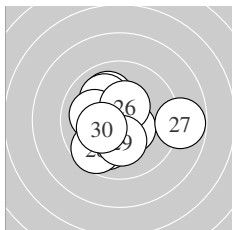

Serie 3:
 10.0 ↓ 10.0 ↖ 10.5 * 10.0 ↖ 10.0 ←
 10.4 * 8.8 → 9.7 ↙ 10.2 * 10.3 *
 beste Teiler 120.2 (23.) 132.2 (26.) 172.9 (30.)
 Trefferlage 0.24 mm links, 0.25 mm tief
 Streuwert 1.97, horizontal: 2.25, vertikal: 1.64

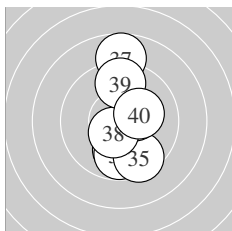

Serie 4:
 10.5 * 10.6 * 9.9 ↓ 9.8 ↓ 9.5 ↘
 10.4 * 8.7 ↑ 10.5 * 9.6 ↑ 10.2 *
 beste Teiler 86.8 (32.) 110.7 (31.) 114.9 (38.)
 Trefferlage 0.51 mm rechts, 0.13 mm tief
 Streuwert 2.06, horizontal: 0.80, vertikal: 2.80

Unterschrift des Schützen