

Ergebnis: **376.3** (356)
 Serien: 97.7 93.2 92.8 92.6
 Zähler: 11 15 13 1 0 0 0 0 0 0
 Innenzehner: 8
 Weitester: 753 (27.), 712 (32.), 684 (19.)
 beste Teiler: 10.2 (5.), 55.2 (1.), 95.6 (26.)
 Trefferlage: 0.36 mm links, 0.83 mm hoch
 Streuwert: 3.03, horizontal: 3.48, vertikal: 2.50

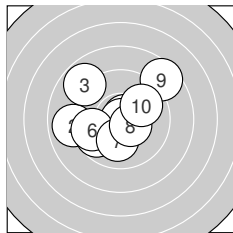
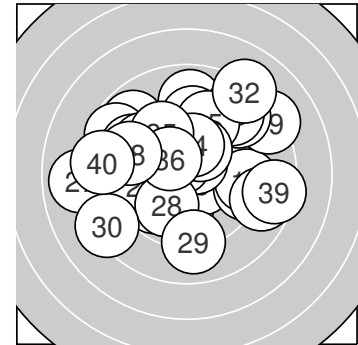

Serie 1:

10.7 *	8.9 ←	8.8 ↘	9.7 ↙	10.9 *
9.7 ←	10.1 ↓	10.5 *	8.5 ↗	9.9 ↗

beste Teiler: 10.2 (5.), 55.2 (1.), 123.8 (8.)
 Trefferlage: 0.65 mm links, 0.32 mm hoch
 Streuwert: 2.56, horizontal: 2.90, vertikal: 2.17

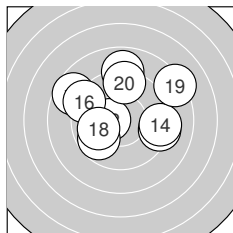

Serie 2:

8.7 ↘	10.5 *	9.3 →	9.3 →	9.7 ↗
9.2 ↘	8.9 ↑	10.0 ←	8.2 ↗	9.4 ↑

beste Teiler: 118.0 (12.), 250.3 (18.), 302.3 (15.)
 Trefferlage: 0.00 mm, 1.32 mm hoch
 Streuwert: 3.13, horizontal: 3.66, vertikal: 2.49

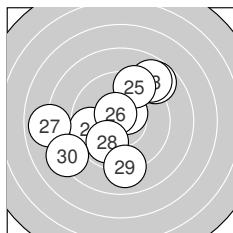

Serie 3:

8.8 ↗	10.5 *	8.8 ↗	9.6 ←	9.4 ↑
10.6 *	7.9 ←	9.9 ↙	9.0 ↓	8.3 ↙

beste Teiler: 95.6 (26.), 105.0 (22.), 260.1 (28.)
 Trefferlage: 0.89 mm links, 0.17 mm hoch
 Streuwert: 3.42, horizontal: 3.64, vertikal: 3.18

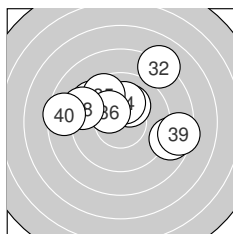

Serie 4:

10.2 *	8.1 ↗	9.5 ↘	10.1 ↑	9.6 ↘
10.3 *	8.7 →	9.2 ↖	8.4 →	8.5 ←

beste Teiler: 162.8 (36.), 196.8 (31.), 208.6 (34.)
 Trefferlage: 0.07 mm rechts, 1.50 mm hoch
 Streuwert: 3.25, horizontal: 4.07, vertikal: 2.12



Ergebnis: **405.6** (388)
 Serien: 102.6 100.2 103.2 99.6
 Zähler: 28 12 0 0 0 0 0 0 0
 Innenzehner: 24
 Weitesten: 387 (39.), 376 (20.), 376 (35.)
 beste Teiler: 35.4 (27.), 37.4 (28.), 83.1 (23.)
 Trefferlage: 0.14 mm rechts, 0.25 mm hoch
 Streuwert: 1.59, horizontal: 1.68, vertikal: 1.50

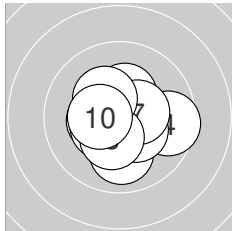
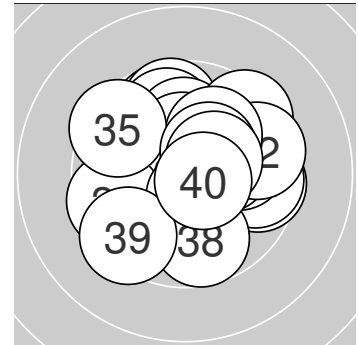

Serie 1:

10.4 *	10.0 ↓	10.3 *	9.6 →	10.4 *
10.4 *	10.4 *	10.4 *	10.3 *	10.4 *

beste Teiler: 127.6 (7.), 137.0 (6.), 137.0 (10.)
 Trefferlage: 0.06 mm rechts, 0.28 mm tief
 Streuwert: 1.36, horizontal: 1.53, vertikal: 1.18

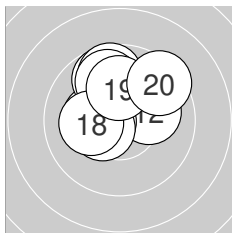

Serie 2:

10.3 *	10.1 →	9.7 ↗	10.5 *	9.7 ↑
10.4 *	9.8 ↖	10.2 *	10.1 ↑	9.4 ↘

beste Teiler: 109.4 (14.), 130.1 (16.), 171.5 (11.)
 Trefferlage: 0.38 mm links, 1.33 mm hoch
 Streuwert: 1.51, horizontal: 1.56, vertikal: 1.47

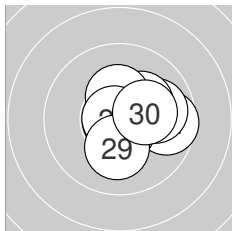

Serie 3:

10.5 *	9.7 →	10.6 *	9.9 →	10.2 *
10.3 *	10.8 *	10.8 *	10.2 *	10.2 *

beste Teiler: 35.4 (27.), 37.4 (28.), 83.1 (23.)
 Trefferlage: 0.87 mm rechts, 0.15 mm hoch
 Streuwert: 1.16, horizontal: 1.30, vertikal: 1.01

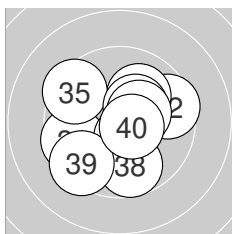

Serie 4:

9.6 ↙	9.6 →	10.5 *	10.1 ↗	9.4 ↖
10.3 *	10.4 *	9.7 ↓	9.4 ↘	10.6 *

beste Teiler: 89.5 (40.), 115.1 (33.), 149.3 (37.)
 Trefferlage: 0.01 mm rechts, 0.16 mm tief
 Streuwert: 2.03, horizontal: 2.22, vertikal: 1.82



Ergebnis: **398.4** (378)
 Serien: 100.8 97.7 100.3 99.6
 Zähler: 23 13 3 1 0 0 0 0 0 0
 Innenzehner: 19
 Weitester: 764 (34.), 534 (13.), 517 (28.)
 beste Teiler: 17.8 (35.), 38.8 (24.), 73.0 (9.)
 Trefferlage: 0.09 mm rechts, 0.04 mm hoch
 Streuwert: 2.10, horizontal: 2.15, vertikal: 2.04

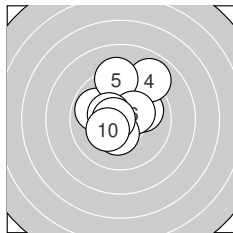
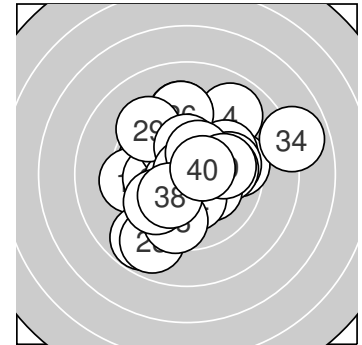

Serie 1:

10.5 *	9.9 ↖	10.0 →	8.9 ↗	9.3 ↑
10.4 *	10.4 *	10.4 *	10.7 *	10.3 *

beste Teiler: 73.0 (9.), 121.2 (1.), 130.0 (8.)
 Trefferlage: 0.11 mm links, 0.81 mm hoch
 Streuwert: 1.82, horizontal: 1.73, vertikal: 1.92

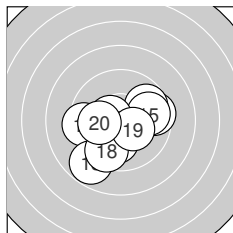

Serie 2:

9.4 ←	9.5 →	8.8 ↙	9.7 ↗	9.8 →
10.0 ↓	10.5 *	9.6 ↘	10.3 *	10.1 ←

beste Teiler: 111.6 (17.), 157.6 (19.), 220.5 (20.)
 Trefferlage: 0.17 mm links, 0.82 mm tief
 Streuwert: 2.27, horizontal: 2.60, vertikal: 1.87

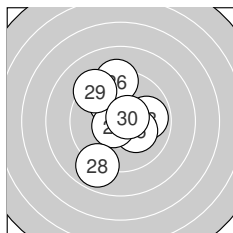

Serie 3:

10.6 *	10.1 ↘	9.9 →	10.8 *	10.2 *
9.3 ↑	10.6 *	8.9 ↙	9.3 ↘	10.6 *

beste Teiler: 38.8 (24.), 82.8 (30.), 89.0 (21.)
 Trefferlage: 0.11 mm links, 0.32 mm hoch
 Streuwert: 2.08, horizontal: 1.68, vertikal: 2.41

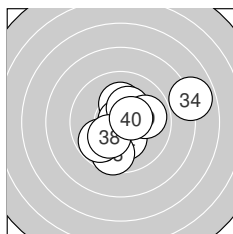

Serie 4:

10.2 *	10.3 *	9.6 ↓	7.9 →	10.9 *
10.3 *	9.8 ↙	10.2 *	9.9 →	10.5 *

beste Teiler: 17.8 (35.), 115.1 (40.), 164.5 (36.)
 Trefferlage: 0.78 mm rechts, 0.14 mm tief
 Streuwert: 2.26, horizontal: 2.61, vertikal: 1.85



Ergebnis: **412.0** (394)
 Serien: 103.0 102.8 103.4 102.8
 Zähler: 34 6 0 0 0 0 0 0 0 0
 Innenzehner: 32
 Weitestе: 468 (32.), 392 (19.), 346 (5.)
 beste Teiler: 0.0 (39.), 43.5 (8.), 48.7 (28.)
 Trefferlage: 0.43 mm links, 0.09 mm tief
 Streuwert: 1.30, horizontal: 1.36, vertikal: 1.25

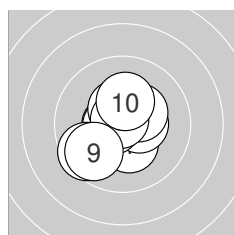
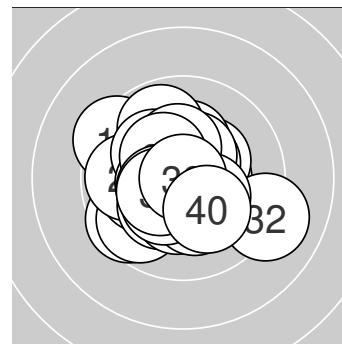

Serie 1:
 10.3 * 10.4 * 10.6 *
 10.5 * 10.3 * 10.8 *
 beste Teiler: 43.5 (8.), 84.7 (4.), 90.0 (3.)
 Trefferlage: 0.41 mm links, 0.16 mm tief
 Streuwert: 1.34, horizontal: 1.34, vertikal: 1.34

10.6 * 9.6 ↙
 9.7 ↘ 10.2 *

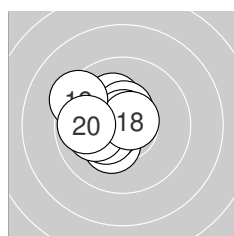

Serie 2:
 10.2 * 10.3 * 10.6 *
 10.8 * 10.1 ← 10.7 *
 beste Teiler: 49.2 (16.), 66.8 (18.), 99.0 (13.)
 Trefferlage: 1.13 mm links, 0.26 mm hoch
 Streuwert: 1.20, horizontal: 1.29, vertikal: 1.12

10.5 * 10.4 *
 9.4 ↘ 9.8 ←

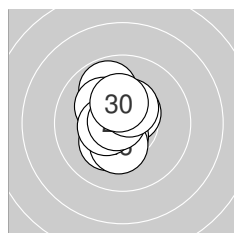

Serie 3:
 10.2 * 9.8 ↖ 10.5 *
 10.3 * 10.4 * 10.8 *
 beste Teiler: 48.7 (28.), 103.3 (25.), 105.4 (23.)
 Trefferlage: 0.50 mm links, 0.31 mm hoch
 Streuwert: 1.11, horizontal: 0.74, vertikal: 1.39

10.2 * 10.5 *
 10.4 * 10.3 *

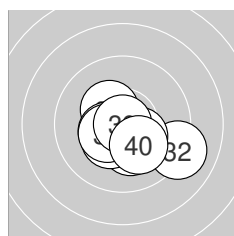

Serie 4:
 10.7 * 9.1 ↗ 10.4 *
 10.3 * 10.4 * 10.3 *
 beste Teiler: 0.0 (39.), 69.4 (31.), 130.1 (35.)
 Trefferlage: 0.32 mm rechts, 0.82 mm tief
 Streuwert: 1.35, horizontal: 1.67, vertikal: 0.91

10.2 * 10.4 *
 10.9 * 10.1 ↘



Ergebnis: **401.6** (385)
 Serien: 99.8 103.1 98.8 99.9
 Zähler: 26 13 1 0 0 0 0 0 0 0
 Innenzehner: 20
 Weitestе: 518 (9.), 500 (22.), 500 (28.)
 beste Teiler: 33.0 (21.), 55.3 (29.), 58.4 (3.)
 Trefferlage: 0.24 mm links, 0.29 mm hoch
 Streuwert: 1.92, horizontal: 2.29, vertikal: 1.47

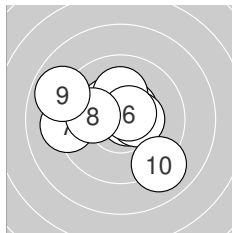
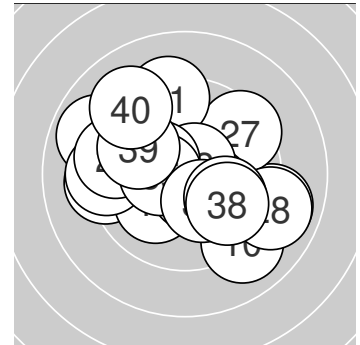

Serie 1:
 10.5 * 10.4 * 10.7 *
 10.6 * 9.2 ← 10.0 ←
 beste Teiler: 58.4 (3.), 83.2 (6.), 112.6 (1.)
 Trefferlage: 0.59 mm links, 0.27 mm hoch
 Streuwert: 2.11, horizontal: 2.51, vertikal: 1.62

10.1 ↑ 10.4 *
 8.9 ↖ 9.0 ↘

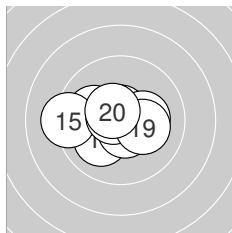

Serie 2:
 10.1 ← 10.7 * 10.1 ↗
 10.6 * 10.7 * 10.2 *
 beste Teiler: 63.0 (14.), 65.3 (17.), 66.3 (12.)
 Trefferlage: 0.47 mm links, 0.02 mm tief
 Streuwert: 1.41, horizontal: 1.85, vertikal: 0.73

10.7 * 9.2 ←
 10.2 * 10.6 *

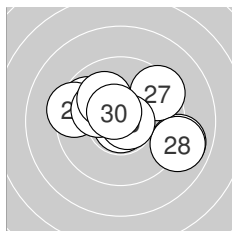

Serie 3:
 10.8 * 9.0 → 9.7 ↖
 10.1 ↘ 9.4 ↗ 9.0 →
 beste Teiler: 33.0 (21.), 55.3 (29.), 93.4 (30.)
 Trefferlage: 0.28 mm rechts, 0.41 mm hoch
 Streuwert: 2.32, horizontal: 2.97, vertikal: 1.39

9.4 ← 10.1 ↖
 10.7 * 10.6 *

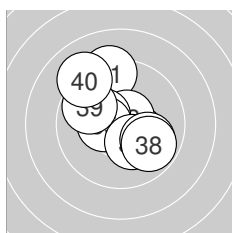

Serie 4:
 9.3 ↑ 10.3 * 10.7 *
 10.3 * 9.9 → 9.8 ↘
 beste Teiler: 73.5 (33.), 133.0 (35.), 157.0 (34.)
 Trefferlage: 0.18 mm links, 0.52 mm hoch
 Streuwert: 1.97, horizontal: 1.90, vertikal: 2.04

10.3 * 10.4 *
 9.8 ↖ 9.1 ↘



Ergebnis: **365.7** (349)
 Serien: 97.9 86.8 85.7 95.3
 Zähler: 10 15 11 2 2 0 0 0 0 0
 Innenzehner: 6
 Weitester: 1185 (14.), 1143 (29.), 860 (27.)
 beste Teiler: 90.1 (7.), 99.7 (2.), 142.2 (34.)
 Trefferlage: 0.40 mm rechts, 0.49 mm hoch
 Streuwert: 3.70, horizontal: 4.34, vertikal: 2.93

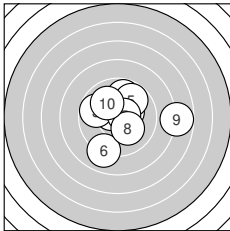
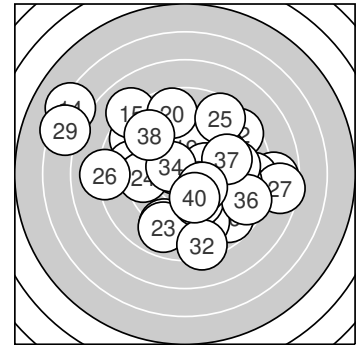

Serie 1:
 9.8 ↗ 10.6 * 9.8 ↖ 10.4 * 9.8 ↗
 9.0 ↘ 10.6 * 10.1 ↘ 7.8 → 10.0 ↘
 beste Teiler: 90.1 (7.), 99.7 (2.), 150.7 (4.)
 Trefferlage: 0.70 mm rechts, 0.31 mm hoch
 Streuwert: 2.59, horizontal: 3.00, vertikal: 2.10

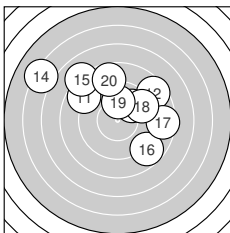

Serie 2:
 8.8 ↖ 8.5 ↗ 9.9 ↗ 6.2 ↖ 8.0 ↖
 8.8 ↘ 8.5 → 9.4 ↗ 10.0 ↑ 8.7 ↑
 beste Teiler: 243.1 (19.), 271.5 (13.), 377.1 (18.)
 Trefferlage: 0.07 mm links, 2.57 mm hoch
 Streuwert: 4.22, horizontal: 5.16, vertikal: 2.99

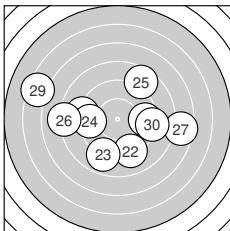

Serie 3:
 9.0 ↖ 9.1 ↘ 8.9 ↘ 9.5 ↖ 8.6 ↗
 8.1 ↖ 7.5 → 9.5 → 6.4 ↖ 9.1 →
 beste Teiler: 370.0 (28.), 375.9 (24.), 460.1 (22.)
 Trefferlage: 0.66 mm links, 0.16 mm tief
 Streuwert: 4.76, horizontal: 6.00, vertikal: 3.05

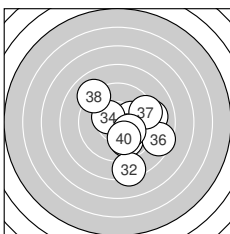

Serie 4:
 9.9 ↘ 8.4 ↘ 10.2 * 10.4 * 9.1 →
 8.6 → 9.4 → 9.1 ↖ 10.2 * 10.0 ↘
 beste Teiler: 142.2 (34.), 191.0 (33.), 194.8 (39.)
 Trefferlage: 1.63 mm rechts, 0.75 mm tief
 Streuwert: 2.66, horizontal: 2.59, vertikal: 2.72



Ergebnis: **364.6** (344)
 Serien: 93.1 89.2 91.1 91.2
 Zähler: 7 19 8 3 3 0 0 0 0 0
 Innenzehner: 7
 Weitester: 1163 (31.), 1129 (1.), 1021 (22.)
 beste Teiler: 85.2 (27.), 120.4 (26.), 129.5 (30.)
 Trefferlage: 2.77 mm links, 1.48 mm hoch
 Streuwert: 3.08, horizontal: 3.26, vertikal: 2.89

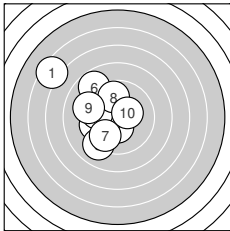
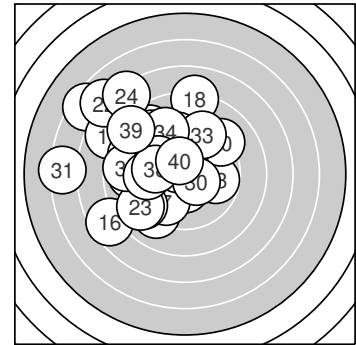

Serie 1:

6.4 ↘	10.4 *	9.6 ←	9.8 ←	9.1 ↗
8.8 ↘	9.7 ↗	9.8 ↑	9.2 ↘	10.3 *

beste Teiler: 142.0 (2.), 153.1 (10.), 294.5 (8.)
 Trefferlage: 2.65 mm links, 0.71 mm hoch
 Streuwert: 3.03, horizontal: 2.92, vertikal: 3.15

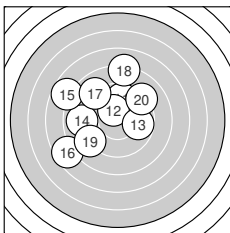

Serie 2:

9.7 ↑	10.3 *	9.8 →	8.9 ←	7.7 ↘
7.6 ↙	9.0 ↘	8.1 ↑	9.0 ↗	9.1 ↗

beste Teiler: 151.9 (12.), 296.7 (13.), 311.8 (11.)
 Trefferlage: 1.92 mm links, 1.39 mm hoch
 Streuwert: 3.71, horizontal: 3.93, vertikal: 3.49

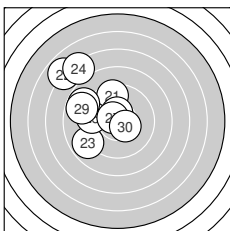

Serie 3:

9.5 ↑	6.9 ↘	8.9 ↙	7.2 ↘	9.5 ←
10.5 *	10.6 *	8.8 ↘	8.8 ↘	10.4 *

beste Teiler: 85.2 (27.), 120.4 (26.), 129.5 (30.)
 Trefferlage: 3.14 mm links, 2.06 mm hoch
 Streuwert: 3.05, horizontal: 2.86, vertikal: 3.22

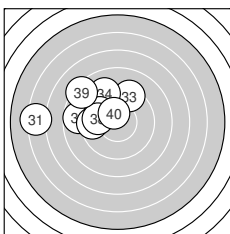

Serie 4:

6.3 ←	9.9 ↘	9.3 ↑	9.2 ↘	8.7 ←
9.8 ↘	9.5 ←	9.8 ←	8.3 ↘	10.4 *

beste Teiler: 136.3 (40.), 261.4 (32.), 284.0 (38.)
 Trefferlage: 3.39 mm links, 1.76 mm hoch
 Streuwert: 2.77, horizontal: 3.57, vertikal: 1.64



LG 40 ZR – Wertung –
StandNr: 121
Moser,, Letizia #70415221

Jungschützinnen

StartNr: 14
3. Mai 2022 15:25
SG_Münster

Ergebnis: **0.0** (0)_{,DNS}
Serien:
Zähler: 0 0 0 0 0 0 0 0 0 0
Innenzehner: 0
Weiteste:
~~beste Teile~~_{nicht gestartet}
Trefferlage: 0.00 mm , 0.00 mm
Streuwert:

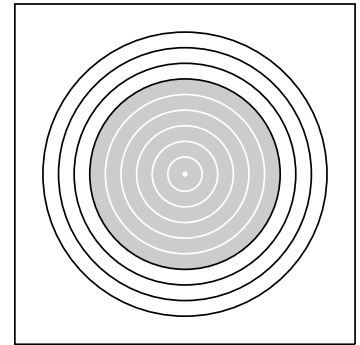

Ergebnis: **333.1** (316)
 Serien: 72.8 85.6 87.4 87.3
 Zähler: 9 10 5 7 6 1 0 2 0 0
 Innenzehner: 7
 Weitester: 1893 (2.), 1878 (5.), 1372 (4.)
 beste Teiler: 9.0 (9.), 83.0 (20.), 96.3 (31.)
 Trefferlage: 0.93 mm rechts, 0.01 mm hoch
 Streuwert: 5.67, horizontal: 5.90, vertikal: 5.42

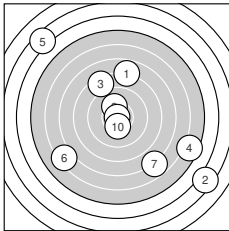
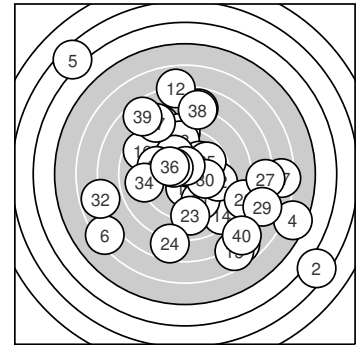

Serie 1:

7.8 ↑	3.4 ↘	8.3 ↖	5.5 ↘	3.4 ↖
6.2 ↙	6.8 ↘	10.2 *	10.9 *	10.3 *

beste Teiler: 9.0 (9.), 158.0 (10.), 198.0 (8.)
 Trefferlage: 0.99 mm rechts, 0.44 mm tief
 Streuwert: 8.32, horizontal: 8.83, vertikal: 7.78

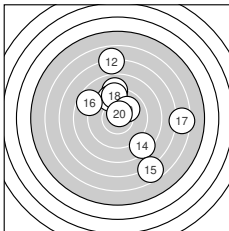

Serie 2:

9.0 ↑	6.9 ↑	9.5 ↖	8.4 ↘	6.7 ↘
8.7 ↖	6.4 →	9.4 ↑	10.0 ↗	10.6 *

beste Teiler: 83.0 (20.), 228.4 (19.), 369.6 (13.)
 Trefferlage: 1.49 mm rechts, 1.30 mm hoch
 Streuwert: 4.93, horizontal: 4.57, vertikal: 5.26

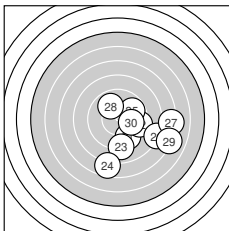

Serie 3:

9.5 ↘	9.4 →	9.0 ↓	7.6 ↓	9.8 ↗
8.0 ↘	7.2 →	9.9 ↖	7.0 ↘	10.0 →

beste Teiler: 245.2 (30.), 259.0 (28.), 294.4 (25.)
 Trefferlage: 3.35 mm rechts, 2.10 mm tief
 Streuwert: 3.55, horizontal: 3.95, vertikal: 3.11

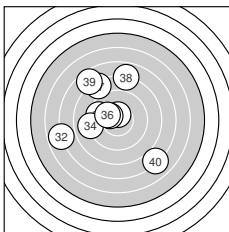

Serie 4:

10.6 *	6.8 ←	9.6 ↖	9.0 ←	10.4 *
10.2 *	8.2 ↖	7.9 ↑	7.6 ↖	7.0 ↘

beste Teiler: 96.3 (31.), 150.9 (35.), 199.0 (36.)
 Trefferlage: 2.11 mm links, 1.28 mm hoch
 Streuwert: 4.47, horizontal: 4.39, vertikal: 4.54



Ergebnis: **385.9** (364)
 Serien: 96.2 96.8 94.9 98.0
 Zähler: 11 22 7 0 0 0 0 0 0 0
 Innenzehner: 8
 Weitester: 630 (22.), 627 (15.), 610 (10.)
 beste Teiler: 52.4 (2.), 68.6 (12.), 79.0 (1.)
 Trefferlage: 0.67 mm links, 0.80 mm hoch
 Streuwert: 2.46, horizontal: 2.82, vertikal: 2.04

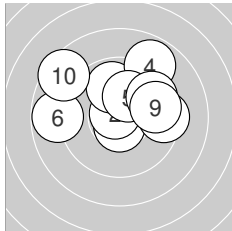
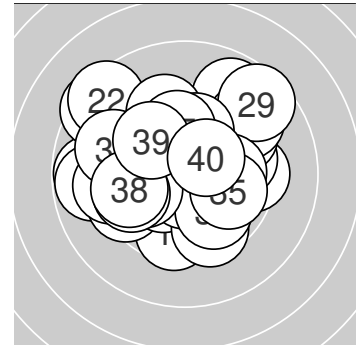

Serie 1:

10.6 *	10.7 *	9.9 ↑	8.9 ↗	10.2 *
8.8 ←	9.6 ↗	9.4 →	9.6 →	8.5 ↘

beste Teiler: 52.4 (2.), 79.0 (1.), 197.3 (5.)
 Trefferlage: 0.18 mm rechts, 1.49 mm hoch
 Streuwert: 2.58, horizontal: 3.22, vertikal: 1.71

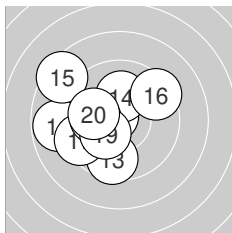

Serie 2:

8.8 ←	10.7 *	9.6 ↓	10.1 ↑	8.4 ↘
9.4 ↗	9.4 ←	10.1 ←	10.3 *	10.0 ←

beste Teiler: 68.6 (12.), 169.8 (19.), 206.4 (14.)
 Trefferlage: 1.73 mm links, 0.24 mm hoch
 Streuwert: 2.32, horizontal: 2.53, vertikal: 2.08

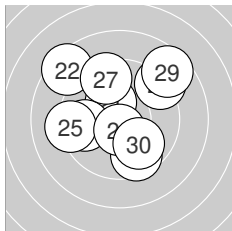

Serie 3:

10.3 *	8.4 ↘	9.1 ↗	9.7 ←	9.2 ←
9.6 ↓	9.5 ↑	10.6 *	8.6 ↗	9.9 ↘

beste Teiler: 94.0 (28.), 165.0 (21.), 269.8 (30.)
 Trefferlage: 0.30 mm links, 0.92 mm hoch
 Streuwert: 2.91, horizontal: 3.06, vertikal: 2.75

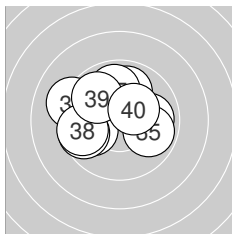

Serie 4:

9.2 ↘	9.9 →	9.9 ↑	9.9 ←	9.9 →
9.6 ←	9.9 ↑	9.6 ←	9.8 ↘	10.3 *

beste Teiler: 156.0 (40.), 251.2 (32.), 253.4 (34.)
 Trefferlage: 0.84 mm links, 0.58 mm hoch
 Streuwert: 2.04, horizontal: 2.47, vertikal: 1.50



Ergebnis: **386.8** (371)
 Serien: 95.7 94.5 99.5 97.1
 Zähler: 19 16 2 3 0 0 0 0 0 0
 Innenzehner: 10
 Weitester: 967 (5.), 936 (14.), 920 (13.)
 beste Teiler: 57.0 (28.), 71.4 (30.), 78.3 (12.)
 Trefferlage: 1.53 mm rechts, 0.27 mm hoch
 Streuwert: 2.52, horizontal: 3.24, vertikal: 1.48

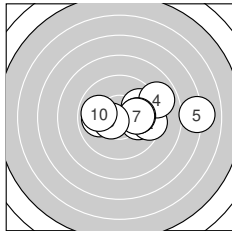
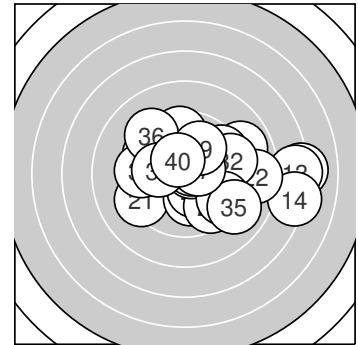

Serie 1:

10.0 →	9.4 →	9.8 ↗	8.9 ↗	7.1 →
10.1 →	10.1 →	9.9 ←	10.5 *	9.9 ←

beste Teiler: 116.4 (9.), 213.4 (7.), 225.8 (6.)
 Trefferlage: 2.10 mm rechts, 0.28 mm hoch
 Streuwert: 2.65, horizontal: 3.65, vertikal: 0.88

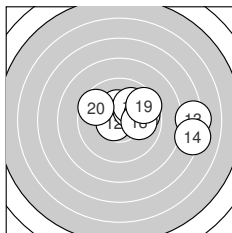

Serie 2:

10.3 *	10.6 *	7.3 →	7.2 →	10.2 *
10.0 ↗	9.8 →	10.0 →	9.5 ↗	9.6 ↖

beste Teiler: 78.3 (12.), 158.0 (11.), 189.0 (15.)
 Trefferlage: 2.53 mm rechts, 0.64 mm hoch
 Streuwert: 2.92, horizontal: 3.94, vertikal: 1.25

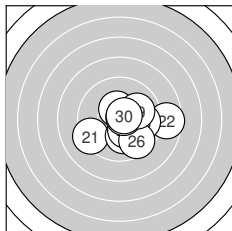

Serie 3:

9.3 ←	8.6 →	9.8 →	10.1 ↓	10.3 *
9.6 ↘	10.4 *	10.7 *	10.0 →	10.7 *

beste Teiler: 57.0 (28.), 71.4 (30.), 132.2 (27.)
 Trefferlage: 1.13 mm rechts, 0.58 mm tief
 Streuwert: 1.99, horizontal: 2.44, vertikal: 1.39

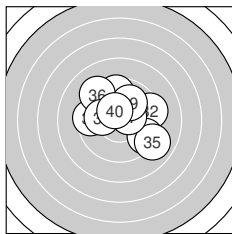

Serie 4:

9.6 ↑	9.4 →	9.4 ↘	9.5 ←	9.0 ↘
9.2 ↘	10.5 *	10.1 ←	10.0 ↗	10.4 *

beste Teiler: 119.9 (37.), 132.3 (40.), 221.7 (38.)
 Trefferlage: 0.37 mm rechts, 0.74 mm hoch
 Streuwert: 2.41, horizontal: 2.77, vertikal: 1.99



Ergebnis: **377.2** (357)
 Serien: 96.3 95.6 91.1 94.2
 Zähler: 12 18 6 3 1 0 0 0 0 0
 Innenzehner: 10
 Weitester: 1090 (10.), 961 (21.), 841 (17.)
 beste Teiler: 34.7 (7.), 72.2 (36.), 119.8 (4.)
 Trefferlage: 0.14 mm rechts, 1.11 mm hoch
 Streuwert: 3.12, horizontal: 3.67, vertikal: 2.45

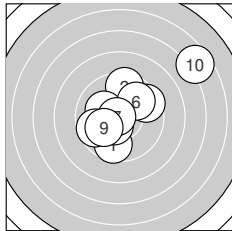
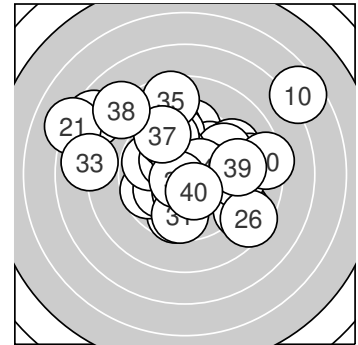

Serie 1:

9.6 ↓ 9.5 ↑ 9.5 ↗
 9.9 ↗ 10.8 * 9.7 ↖

10.5 * 10.1 ↖
 10.1 ↖ 6.6 ↗

beste Teiler: 34.7 (7.), 119.8 (4.), 202.6 (5.)
 Trefferlage: 0.63 mm rechts, 0.77 mm hoch
 Streuwert: 3.11, horizontal: 3.43, vertikal: 2.75

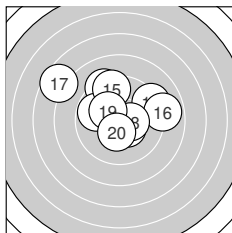

Serie 2:

10.4 * 9.3 ↘ 9.2 ↗
 8.9 → 7.6 ↖ 10.4 *

9.8 ↖ 9.4 ↑
 10.2 * 10.4 *

beste Teiler: 129.4 (18.), 130.1 (11.), 145.2 (20.)
 Trefferlage: 0.34 mm links, 1.44 mm hoch
 Streuwert: 2.82, horizontal: 3.44, vertikal: 2.02

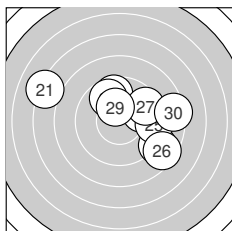

Serie 3:

7.1 ↖ 9.9 → 8.8 ↘
 8.5 ↘ 9.5 → 9.7 ↘

9.6 ↑ 9.3 →
 10.3 * 8.4 →

beste Teiler: 173.6 (29.), 273.0 (22.), 303.6 (28.)
 Trefferlage: 1.42 mm rechts, 0.84 mm hoch
 Streuwert: 3.60, horizontal: 4.46, vertikal: 2.44

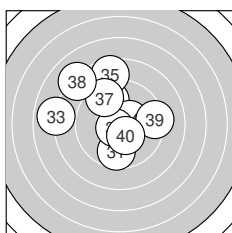

Serie 4:

9.7 ↓ 9.7 ↘ 7.9 ←
 10.7 * 9.5 ↘ 8.1 ↖

10.4 * 8.6 ↑
 9.3 → 10.3 *

beste Teiler: 72.2 (36.), 131.0 (34.), 152.5 (40.)
 Trefferlage: 1.14 mm links, 1.39 mm hoch
 Streuwert: 3.04, horizontal: 3.24, vertikal: 2.83



Ergebnis: **391.3** (370)
 Serien: 96.6 98.4 99.5 96.8
 Zähler: 17 17 5 1 0 0 0 0 0 0
 Innenzehner: 15
 Weitester: 865 (38.), 701 (2.), 661 (18.)
 beste Teiler: 8.6 (39.), 54.0 (36.), 63.3 (13.)
 Trefferlage: 0.82 mm rechts, 0.21 mm hoch
 Streuwert: 2.38, horizontal: 2.94, vertikal: 1.65

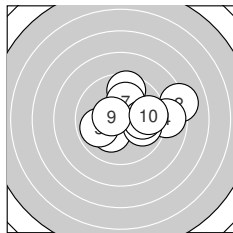
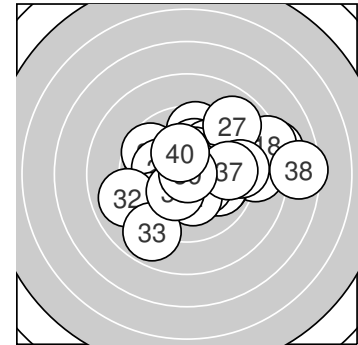

Serie 1:

10.2 *	8.1 →	9.6 ↑	8.8 →	9.9 ←
9.9 ↘	10.1 ↑	9.9 →	10.5 *	9.6 →

beste Teiler: 110.0 (9.), 190.3 (1.), 211.8 (7.)
 Trefferlage: 1.69 mm rechts, 0.47 mm hoch
 Streuwert: 2.34, horizontal: 2.94, vertikal: 1.53

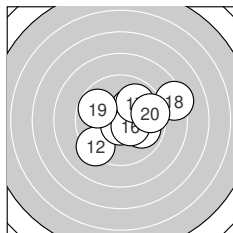

Serie 2:

9.9 ↘	9.3 ↙	10.7 *	10.2 *	10.4 *
10.4 *	9.9 ↗	8.3 →	9.8 ↖	9.5 →

beste Teiler: 63.3 (13.), 134.3 (16.), 140.6 (15.)
 Trefferlage: 1.17 mm rechts, 0.22 mm hoch
 Streuwert: 2.23, horizontal: 2.70, vertikal: 1.63

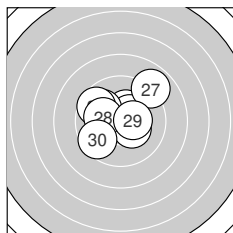

Serie 3:

10.4 *	10.4 *	9.9 ↖	9.9 ↖	10.3 *
9.6 ↖	8.9 ↗	10.1 ←	10.4 *	9.6 ↙

beste Teiler: 132.4 (22.), 143.4 (29.), 150.4 (21.)
 Trefferlage: 0.40 mm links, 0.79 mm hoch
 Streuwert: 1.93, horizontal: 2.23, vertikal: 1.58

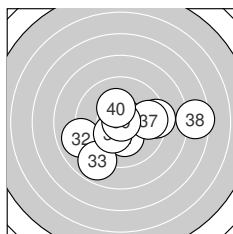

Serie 4:

10.2 *	9.0 ←	8.9 ↙	9.3 →	10.3 *
10.7 *	9.7 →	7.5 →	10.9 *	10.3 *

beste Teiler: 8.6 (39.), 54.0 (36.), 160.5 (35.)
 Trefferlage: 0.81 mm rechts, 0.62 mm tief
 Streuwert: 2.91, horizontal: 3.73, vertikal: 1.74



Ergebnis: **403.7** (383)
 Serien: 100.1 102.0 101.7 99.9
 Zähler: 23 17 0 0 0 0 0 0 0
 Innenzehner: 18
 Weitestе: 430 (11.), 406 (39.), 386 (22.)
 beste Teiler: 38.3 (18.), 58.8 (28.), 59.0 (38.)
 Trefferlage: 0.74 mm links, 0.26 mm hoch
 Streuwert: 1.63, horizontal: 1.75, vertikal: 1.51

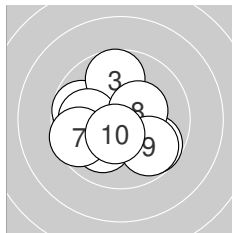
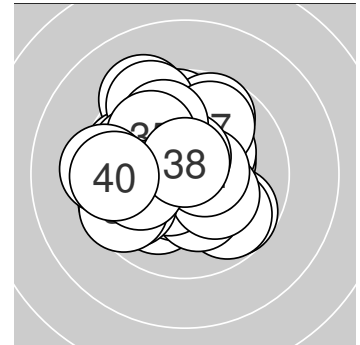

Serie 1:
 9.7 ← 10.6 * 9.7 ↑ 10.1 ↙ 10.0 ←
 9.7 ↘ 9.6 ← 10.4 * 9.8 ↘ 10.5 *
 beste Teiler: 94.6 (2.), 118.6 (10.), 147.1 (8.)
 Trefferlage: 0.40 mm links, 0.42 mm tief
 Streuwert: 1.83, horizontal: 2.05, vertikal: 1.58

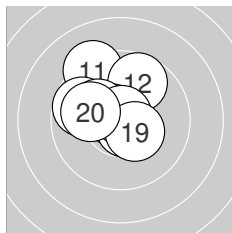

Serie 2:
 9.2 ↘ 9.7 ↑ 10.6 * 9.7 ↘ 10.7 *
 10.7 * 10.2 * 10.8 * 10.4 * 10.0 ←
 beste Teiler: 38.3 (18.), 59.1 (15.), 68.2 (16.)
 Trefferlage: 0.72 mm links, 0.88 mm hoch
 Streuwert: 1.44, horizontal: 1.46, vertikal: 1.42

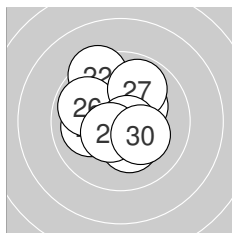

Serie 3:
 10.2 * 9.4 ↘ 10.0 ← 10.3 * 10.6 *
 9.9 ↘ 9.9 ↑ 10.7 * 10.5 * 10.2 *
 beste Teiler: 58.8 (28.), 92.2 (25.), 115.3 (29.)
 Trefferlage: 0.12 mm links, 0.33 mm hoch
 Streuwert: 1.60, horizontal: 1.55, vertikal: 1.64

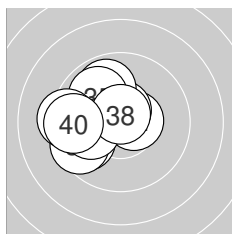

Serie 4:
 9.8 ← 10.6 * 10.6 * 9.9 ↘ 9.9 ↘
 9.6 ← 10.0 ← 10.7 * 9.3 ← 9.5 ←
 beste Teiler: 59.0 (38.), 90.2 (33.), 100.6 (32.)
 Trefferlage: 1.72 mm links, 0.25 mm hoch
 Streuwert: 1.52, horizontal: 1.69, vertikal: 1.32



Ergebnis: **345.1** (328)
 Serien: 79.6 90.9 89.4 85.2
 Zähler: 4 15 10 8 2 1 0 0 0 0
 Innenzehner: 2
 Weitester: 1389 (7.), 1215 (16.), 1143 (36.)
 beste Teiler: 189.6 (18.), 195.3 (11.), 210.1 (26.)
 Trefferlage: 2.55 mm rechts, 1.46 mm hoch
 Streuwert: 4.20, horizontal: 5.10, vertikal: 3.04

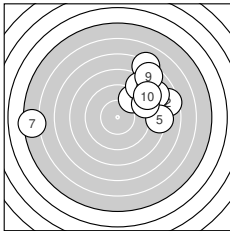
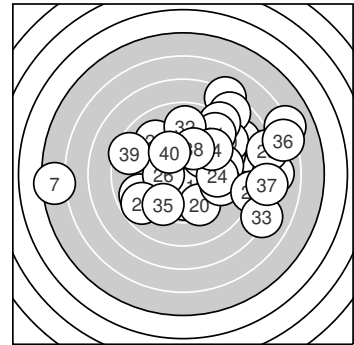

Serie 1:

9.4 ↗	7.6 →	8.1 ↗	7.2 ↗	8.2 →
8.5 ↗	5.4 ←	9.0 ↗	7.6 ↗	8.6 ↗

beste Teiler: 378.4 (1.), 497.8 (8.), 596.2 (10.)
 Trefferlage: 3.20 mm rechts, 3.32 mm hoch
 Streuwert: 4.83, horizontal: 6.21, vertikal: 2.83

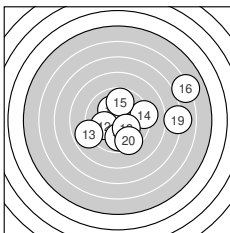

Serie 2:

10.2 *	10.0 ←	8.9 ←	9.2 →	9.8 ↑
6.1 ↗	9.9 ↓	10.2 *	7.1 →	9.5 ↓

beste Teiler: 189.6 (18.), 195.3 (11.), 231.9 (12.)
 Trefferlage: 2.10 mm rechts, 0.03 mm hoch
 Streuwert: 4.00, horizontal: 4.98, vertikal: 2.67

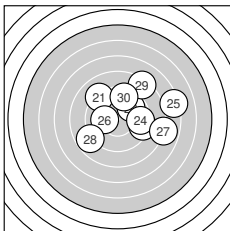

Serie 3:

9.1 ↘	9.3 →	9.8 ↗	9.5 →	7.2 →
10.1 ←	7.9 →	8.8 ↗	8.2 ↗	9.5 ↑

beste Teiler: 210.1 (26.), 285.0 (23.), 371.5 (24.)
 Trefferlage: 2.19 mm rechts, 1.05 mm hoch
 Streuwert: 3.68, horizontal: 4.40, vertikal: 2.79

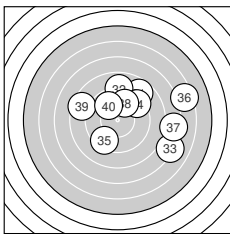

Serie 4:

8.7 ↗	8.9 ↑	7.1 ↘	9.3 ↗	9.4 ↗
6.4 →	7.3 →	9.8 ↑	8.5 ↘	9.8 ↘

beste Teiler: 277.5 (40.), 297.1 (38.), 390.8 (35.)
 Trefferlage: 2.69 mm rechts, 1.41 mm hoch
 Streuwert: 4.47, horizontal: 5.40, vertikal: 3.28



Ergebnis: **394.0** (375)
 Serien: 97.7 99.1 97.2 100.0
 Zähler: 18 19 3 0 0 0 0 0 0 0
 Innenzehner: 11
 Weitester: 684 (14.), 561 (4.), 521 (10.)
 beste Teiler: 60.2 (15.), 69.8 (6.), 89.1 (40.)
 Trefferlage: 0.55 mm links, 0.63 mm hoch
 Streuwert: 2.13, horizontal: 2.55, vertikal: 1.61

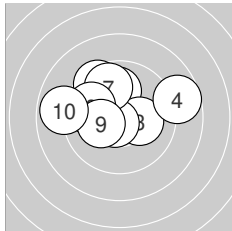
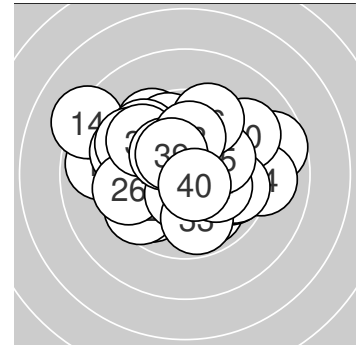

Serie 1:

10.0 ↑	9.5 ↘	10.2 *	8.7 →	9.9 ←
10.7 *	9.8 ↘	9.8 ↘	10.2 *	8.9 ←

beste Teiler: 69.8 (6.), 182.7 (9.), 188.6 (3.)
 Trefferlage: 0.87 mm links, 1.06 mm hoch
 Streuwert: 2.25, horizontal: 2.86, vertikal: 1.38

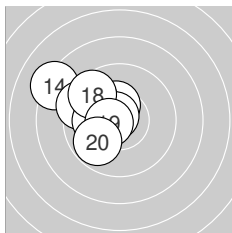

Serie 2:

10.4 *	10.5 *	9.8 ↘	8.2 ↘	10.7 *
9.4 ↘	10.1 ←	9.6 ↘	10.6 *	9.8 ↘

beste Teiler: 60.2 (15.), 100.6 (19.), 110.6 (12.)
 Trefferlage: 2.16 mm links, 0.81 mm hoch
 Streuwert: 1.62, horizontal: 1.71, vertikal: 1.52

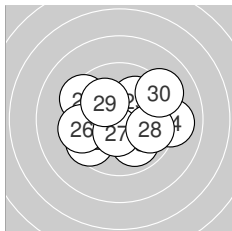

Serie 3:

9.4 ↘	9.6 ↘	9.9 ↘	9.1 →	10.1 ↗
9.5 ←	10.5 *	9.8 →	10.1 ↘	9.2 ↗

beste Teiler: 123.5 (27.), 207.6 (29.), 225.8 (25.)
 Trefferlage: 0.28 mm rechts, 0.00 mm
 Streuwert: 2.44, horizontal: 2.98, vertikal: 1.74

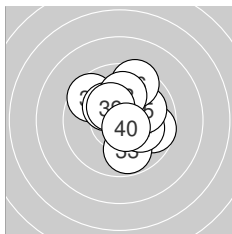

Serie 4:

9.6 ↘	9.7 →	9.8 ↓	10.1 →	10.0 →
9.5 ↗	10.3 *	10.0 ↑	10.4 *	10.6 *

beste Teiler: 89.1 (40.), 148.3 (39.), 173.9 (37.)
 Trefferlage: 0.54 mm rechts, 0.63 mm hoch
 Streuwert: 1.77, horizontal: 1.72, vertikal: 1.83



Ergebnis: **381.1** (365)
 Serien: 93.6 96.8 94.2 96.5
 Zähler: 17 13 8 2 0 0 0 0 0 0
 Innenzehner: 9
 Weitester: 794 (6.), 758 (20.), 700 (27.)
 beste Teiler: 30.0 (13.), 116.4 (3.), 124.2 (25.)
 Trefferlage: 0.71 mm rechts, 0.51 mm tief
 Streuwert: 2.82, horizontal: 2.98, vertikal: 2.64

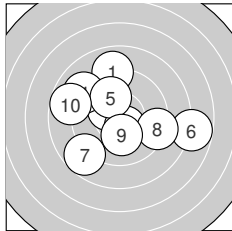
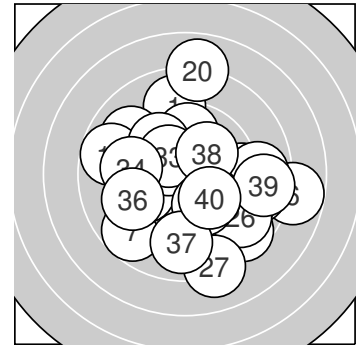

Serie 1:
 9.0 ↑ 10.4 * 10.5 * 9.1 ↘ 10.0 ↓
 7.8 → 8.7 ↙ 9.2 → 10.2 * 8.7 ←
 beste Teiler: 116.4 (3.), 147.8 (2.), 194.3 (9.)
 Trefferlage: 0.32 mm links, 0.23 mm hoch
 Streuwert: 3.34, horizontal: 3.92, vertikal: 2.64

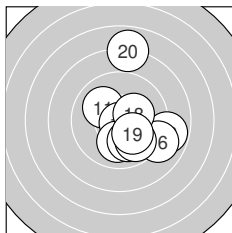

Serie 2:
 10.0 ↘ 8.8 → 10.8 * 10.0 ↓ 10.0 ↓
 9.0 ↘ 9.8 ↘ 10.3 * 10.2 * 7.9 ↑
 beste Teiler: 30.0 (13.), 167.4 (18.), 200.8 (19.)
 Trefferlage: 1.37 mm rechts, 0.26 mm tief
 Streuwert: 2.58, horizontal: 2.03, vertikal: 3.04

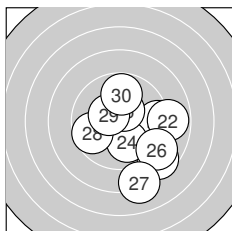

Serie 3:
 9.3 → 8.8 → 8.6 ↘ 10.0 ↓ 10.5 *
 8.9 ↘ 8.2 ↓ 9.7 ← 10.4 * 9.8 ↑
 beste Teiler: 124.2 (25.), 134.9 (29.), 236.3 (24.)
 Trefferlage: 1.70 mm rechts, 1.24 mm tief
 Streuwert: 2.75, horizontal: 2.68, vertikal: 2.83

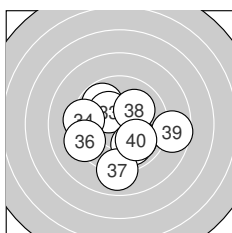

Serie 4:
 9.8 ↘ 10.0 ↘ 10.3 * 9.4 ← 9.9 ↓
 9.3 ← 9.0 ↓ 10.1 ↗ 8.7 → 10.0 ↘
 beste Teiler: 175.5 (33.), 220.6 (38.), 245.6 (32.)
 Trefferlage: 0.11 mm rechts, 0.76 mm tief
 Streuwert: 2.58, horizontal: 2.93, vertikal: 2.17



Ergebnis: **364.3** (348)
 Serien: 92.5 89.7 91.4 90.7
 Zähler: 11 12 13 2 2 0 0 0 0 0
 Innenzehner: 5
 Weitester: 1193 (13.), 1118 (17.), 836 (21.)
 beste Teiler: 44.2 (14.), 63.5 (15.), 105.0 (22.)
 Trefferlage: 0.07 mm links, 0.84 mm tief
 Streuwert: 3.71, horizontal: 4.21, vertikal: 3.14

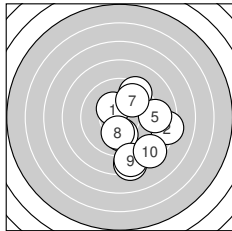
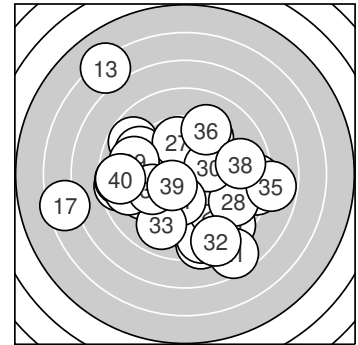

Serie 1:

10.4 *	8.3 →	8.4 ↓	9.4 ↗	9.0 →
10.0 ↓	9.8 ↗	10.1 ↓	8.6 ↓	8.5 ↘

beste Teiler: 146.8 (1.), 209.4 (8.), 237.2 (6.)
 Trefferlage: 2.11 mm rechts, 1.56 mm tief
 Streuwert: 2.86, horizontal: 2.33, vertikal: 3.30

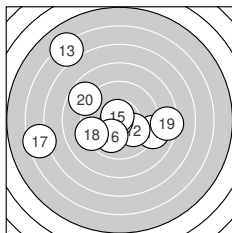

Serie 2:

9.0 →	10.0 ↘	6.2 ↘	10.8 *	10.7 *
10.0 ↘	6.5 ←	9.3 ←	8.4 →	8.8 ↘

beste Teiler: 44.2 (14.), 63.5 (15.), 226.6 (12.)
 Trefferlage: 1.55 mm links, 0.28 mm hoch
 Streuwert: 4.51, horizontal: 5.23, vertikal: 3.64

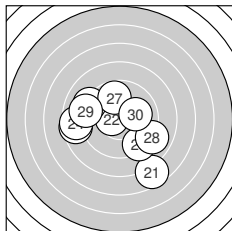

Serie 3:

7.6 ↘	10.5 *	8.5 ←	8.6 ←	9.2 ↘
9.1 ↘	9.8 ↑	8.9 ↘	9.1 ←	10.1 →

beste Teiler: 105.0 (22.), 225.1 (30.), 299.0 (27.)
 Trefferlage: 0.86 mm links, 0.77 mm tief
 Streuwert: 3.57, horizontal: 4.10, vertikal: 2.94

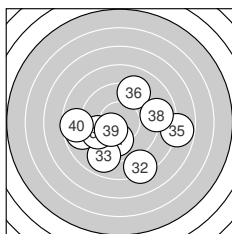

Serie 4:

10.0 ↓	8.3 ↘	9.0 ↓	8.9 ←	7.8 →
9.2 ↗	9.7 ←	8.9 →	10.3 *	8.6 ←

beste Teiler: 154.4 (39.), 238.8 (31.), 324.3 (37.)
 Trefferlage: 0.00 mm, 1.32 mm tief
 Streuwert: 3.64, horizontal: 4.35, vertikal: 2.75



Ergebnis: **378.9** (358)
 Serien: 94.5 91.8 95.9 96.7
 Zähler: 11 19 9 0 0 1 0 0 0 0
 Innenzehner: 8
 Weitester: 1264 (20.), 637 (16.), 635 (35.)
 beste Teiler: 82.1 (13.), 101.0 (40.), 120.5 (36.)
 Trefferlage: 0.41 mm links, 0.20 mm hoch
 Streuwert: 3.02, horizontal: 3.75, vertikal: 2.05

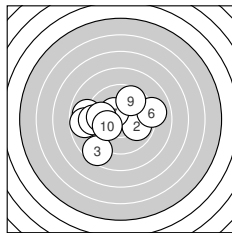
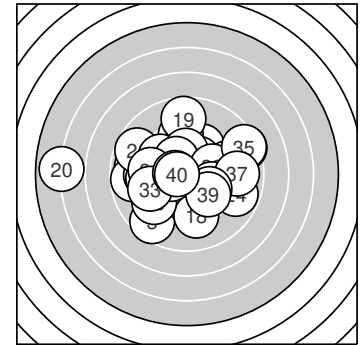

Serie 1:
 8.9 ← 9.9 → 8.6 ↙ 8.8 ← 9.3 ←
 9.0 → 10.4 * 9.8 ← 9.7 ↗ 10.1 ←
 beste Teiler: 142.8 (7.), 223.6 (10.), 262.2 (2.)
 Trefferlage: 1.53 mm links, 0.13 mm tief
 Streuwert: 2.79, horizontal: 3.41, vertikal: 1.97

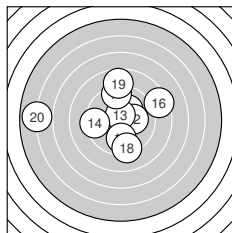

Serie 2:
 10.2 * 10.2 * 10.6 * 9.4 ← 9.9 ↓
 8.4 → 9.3 ↑ 9.2 ↓ 8.7 ↑ 5.9 ←
 beste Teiler: 82.1 (13.), 193.4 (11.), 194.6 (12.)
 Trefferlage: 0.76 mm links, 0.79 mm hoch
 Streuwert: 3.98, horizontal: 4.82, vertikal: 2.90

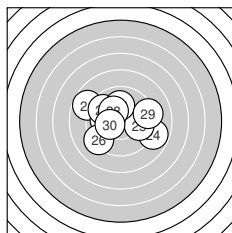

Serie 3:
 8.7 ↖ 10.0 ← 9.7 ↖ 8.8 → 9.8 →
 9.2 ↙ 10.0 ↑ 10.2 * 9.2 → 10.3 *
 beste Teiler: 168.2 (30.), 188.0 (28.), 235.6 (22.)
 Trefferlage: 0.42 mm links, 0.34 mm hoch
 Streuwert: 2.68, horizontal: 3.33, vertikal: 1.81

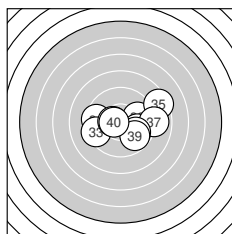

Serie 4:
 9.5 ← 9.9 → 9.4 ← 9.9 → 8.4 →
 10.5 * 8.9 → 9.9 ↘ 9.8 ↘ 10.5 *
 beste Teiler: 101.0 (40.), 120.5 (36.), 266.6 (32.)
 Trefferlage: 1.06 mm rechts, 0.19 mm tief
 Streuwert: 2.55, horizontal: 3.32, vertikal: 1.39



Ergebnis: **367.9** (351)
 Serien: 86.9 90.5 94.3 96.2
 Zähler: 9 19 8 2 2 0 0 0 0 0
 Innenzehner: 8
 Weitester: 1167 (12.), 1016 (4.), 974 (8.)
 beste Teiler: 89.4 (18.), 121.0 (35.), 132.6 (33.)
 Trefferlage: 0.24 mm links, 1.11 mm hoch
 Streuwert: 3.53, horizontal: 4.45, vertikal: 2.26

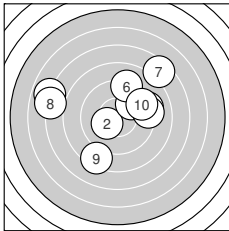
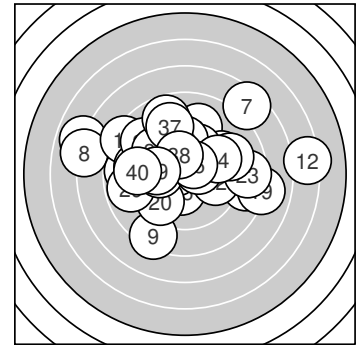

Serie 1:

9.2 →	10.3 *	9.9 ↗	6.9 ←	9.2 →
9.1 ↑	7.5 ↗	7.1 ←	8.3 ↘	9.4 ↗

beste Teiler: 173.4 (2.), 270.1 (3.), 390.1 (10.)
 Trefferlage: 0.25 mm links, 1.53 mm hoch
 Streuwert: 4.59, horizontal: 5.61, vertikal: 3.27

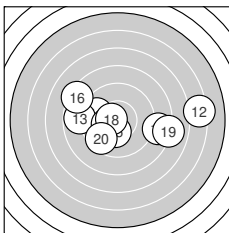

Serie 2:

9.7 ←	6.3 →	8.8 ←	10.3 *	10.3 *
8.3 ↖	8.6 →	10.6 *	8.0 →	9.6 ↘

beste Teiler: 89.4 (18.), 158.1 (14.), 166.1 (15.)
 Trefferlage: 0.54 mm rechts, 0.15 mm tief
 Streuwert: 4.23, horizontal: 5.74, vertikal: 1.72

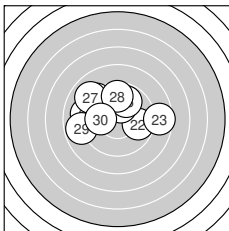

Serie 3:

9.1 ←	9.8 →	8.6 →	10.2 *	9.3 ↘
9.8 ↗	9.0 ↖	9.7 ↑	8.8 ←	10.0 ←

beste Teiler: 177.0 (24.), 240.0 (30.), 276.8 (26.)
 Trefferlage: 0.83 mm links, 1.21 mm hoch
 Streuwert: 2.78, horizontal: 3.56, vertikal: 1.68

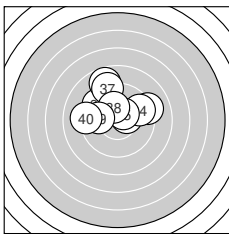

Serie 4:

9.5 ↖	9.1 →	10.4 *	9.6 →	10.5 *
8.7 ↑	9.1 ↑	10.2 *	9.9 ←	9.2 ←

beste Teiler: 121.0 (35.), 132.6 (33.), 189.8 (38.)
 Trefferlage: 0.42 mm links, 1.86 mm hoch
 Streuwert: 2.31, horizontal: 2.77, vertikal: 1.73

