

Ergebnis:	395	(412.4)
Serien:	99	100 98 98
Zähler:	35 5	0 0 0 0 0 0 0 0
Innenzehner:	29	
weiteste:	428 (26), 372 (23), 346 (7)	
beste Teiler	36.4 (13.)	44.0 (3.) 46.0 (35.)
Trefferlage	0.02 mm links, 0.43 mm hoch	
Streuwert	1.28, horizontal: 1.43, vertikal: 1.11	

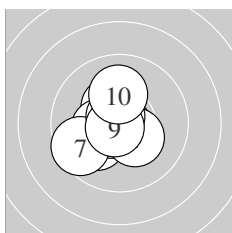

Serie 1:

10.1 ↙	10.7 *	10.8 *	10.3 *	10.4 *
10.4 *	9.6 ↙	10.7 *	10.8 *	10.1 ↑
beste Teiler	44.0 (3.) 48.9 (9.) 60.2 (8.)			
Trefferlage	0.68 mm links, 0.17 mm tief			
Streuwert	1.18, horizontal: 1.15, vertikal: 1.20			

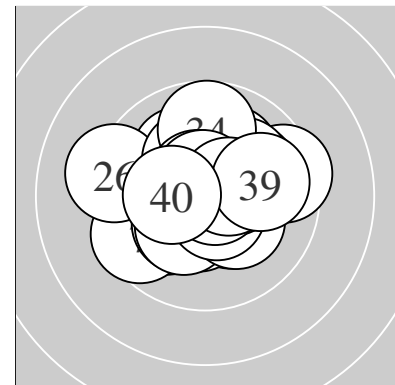
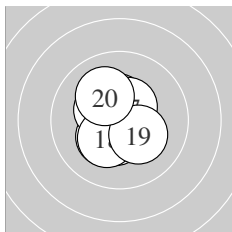

Serie 2:

10.5 *	10.7 *	10.8 *	10.3 *	10.4 *
10.4 *	10.5 *	10.3 *	10.2 *	10.1 ↘
beste Teiler	36.4 (13.) 69.8 (12.) 119.8 (17.)			
Trefferlage	0.38 mm links, 0.03 mm hoch			
Streuwert	1.04, horizontal: 0.86, vertikal: 1.20			

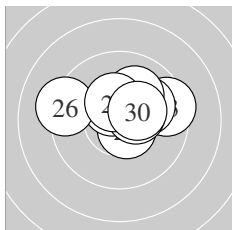

Serie 3:

10.3 *	10.6 *	9.5 →	10.5 *	10.0 ↗
9.2 ↖	10.4 *	10.1 ↑	10.4 *	10.3 *
beste Teiler	88.4 (22.) 117.7 (24.) 130.9 (27.)			
Trefferlage	0.59 mm rechts, 0.86 mm hoch			
Streuwert	1.52, horizontal: 2.04, vertikal: 0.68			

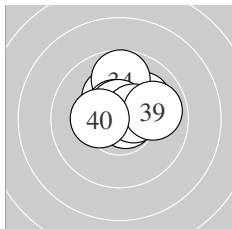

Serie 4:

10.3 *	10.1 ↗	10.2 *	9.7 ↑	10.8 *
10.6 *	10.6 *	10.5 *	9.9 →	10.3 *
beste Teiler	46.0 (35.) 77.6 (37.) 85.0 (36.)			
Trefferlage	0.38 mm rechts, 1.03 mm hoch			
Streuwert	1.05, horizontal: 1.18, vertikal: 0.91			

Unterschrift des Schützen

Meyton Elektronik

Ergebnis: **387** (404.5)
 Serien: 99 97 96 95
 Zähler: 27 13 0 0 0 0 0 0 0 0
 Innenzehner: 20
 weiteste: 464 (21), 397 (24), 395 (39)
 beste Teiler 1.4 (7.) 4.0 (23.) 75.6 (5.)
 Trefferlage 0.39 mm rechts, 0.03 mm hoch
 Streuwert 1.68, horizontal: 2.12, vertikal: 1.06

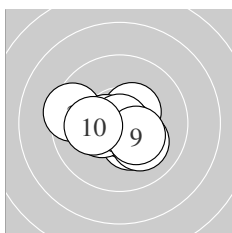
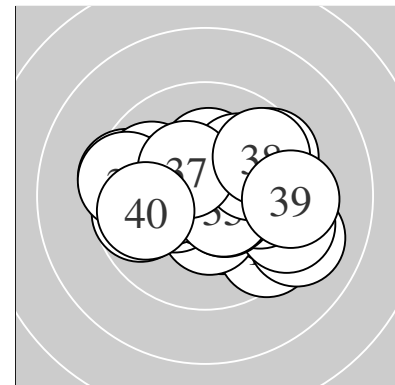

Serie 1:
 10.4 * 10.5 * 9.5 ← 10.3 * 10.7 *
 10.4 * 10.9 * 10.1 ↘ 10.3 * 10.1 ←
 beste Teiler 1.4 (7.) 75.6 (5.) 106.1 (2.)
 Trefferlage 0.29 mm links, 0.32 mm tief
 Streuwert 1.31, horizontal: 1.67, vertikal: 0.79

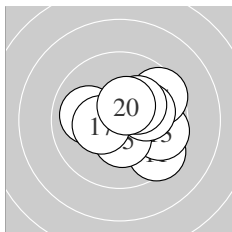

Serie 2:
 9.5 ↘ 10.4 * 9.7 → 9.6 ↗ 10.4 *
 10.0 ← 10.4 * 10.1 → 10.2 * 10.5 *
 beste Teiler 122.1 (20.) 134.4 (12.) 140.5 (15.)
 Trefferlage 1.02 mm rechts, 0.10 mm hoch
 Streuwert 1.61, horizontal: 1.86, vertikal: 1.32

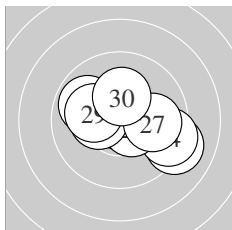

Serie 3:
 9.1 ↘ 10.6 * 10.9 * 9.4 → 10.5 *
 10.3 * 9.9 → 9.9 ← 10.1 ← 10.2 *
 beste Teiler 4.0 (23.) 80.4 (22.) 108.2 (25.)
 Trefferlage 0.63 mm rechts, 0.01 mm tief
 Streuwert 1.81, horizontal: 2.32, vertikal: 1.10

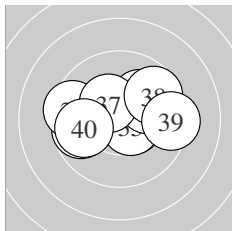

Serie 4:
 10.5 * 9.7 ← 9.5 ← 10.1 ↗ 10.5 *
 10.0 ↗ 10.4 * 9.7 ↗ 9.4 → 9.8 ←
 beste Teiler 102.0 (35.) 113.7 (31.) 148.4 (37.)
 Trefferlage 0.19 mm rechts, 0.37 mm hoch
 Streuwert 1.98, horizontal: 2.61, vertikal: 1.01

Unterschrift des Schützen

Ergebnis: **387** (404.3)
 Serien: 96 96 97 98
 Zähler: 27 13 0 0 0 0 0 0 0 0
 Innenzehner: 22
 weiteste: 496 (8), 465 (10), 439 (6)
 beste Teiler 8.2 (32.) 18.3 (17.) 80.0 (3.)
 Trefferlage 0.15 mm rechts, 0.90 mm hoch
 Streuwert 1.57, horizontal: 1.77, vertikal: 1.33

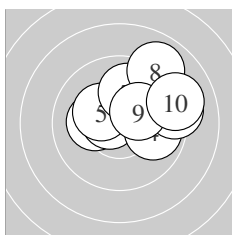
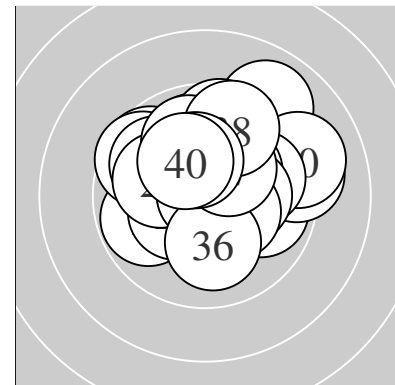

Serie 1:
 10.6 * 10.2 * 10.6 * 9.9 → 10.3 *
 9.2 → 10.0 † 9.0 † 10.3 * 9.1 →
 beste Teiler 80.0 (3.) 88.0 (1.) 166.5 (5.)
 Trefferlage 1.13 mm rechts, 1.12 mm hoch
 Streuwert 1.89, horizontal: 2.32, vertikal: 1.34

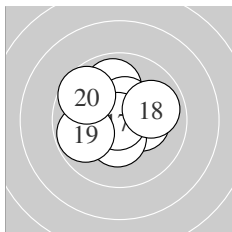

Serie 2:
 10.4 * 10.5 * 9.9 † 10.3 * 10.5 *
 10.4 * 10.9 * 9.9 → 9.8 ← 9.7 ↘
 beste Teiler 18.3 (17.) 116.2 (12.) 121.1 (15.)
 Trefferlage 0.37 mm links, 0.39 mm hoch
 Streuwert 1.46, horizontal: 1.63, vertikal: 1.28

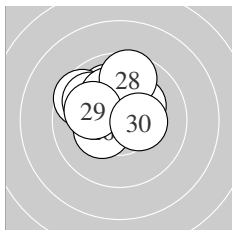

Serie 3:
 10.0 † 9.6 ↖ 10.4 * 9.9 ↖ 10.2 *
 10.3 * 10.1 † 9.6 † 10.1 ↖ 10.4 *
 beste Teiler 134.3 (23.) 149.6 (30.) 154.8 (26.)
 Trefferlage 0.55 mm links, 1.19 mm hoch
 Streuwert 1.41, horizontal: 1.64, vertikal: 1.15

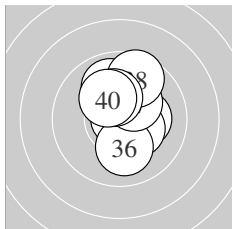

Serie 4:
 10.2 * 10.9 * 9.9 † 10.3 * 10.4 *
 10.1 ↓ 10.3 * 9.6 † 10.3 * 10.2 *
 beste Teiler 8.2 (32.) 149.5 (35.) 161.5 (34.)
 Trefferlage 0.43 mm rechts, 0.88 mm hoch
 Streuwert 1.30, horizontal: 0.94, vertikal: 1.58

Unterschrift des Schützen

Meyton Elektronik

Ergebnis: **382** (402.1)
 Serien: 99 95 96 92
 Zähler: 24 14 2 0 0 0 0 0 0 0
 Innenzehner: 19
 weiteste: 697 (39), 513 (33), 455 (30)
 beste Teiler 45.5 (16.) 48.7 (29.) 73.6 (34.)
 Trefferlage 0.07 mm rechts, 0.23 mm tief
 Streuwert 1.87, horizontal: 2.28, vertikal: 1.32

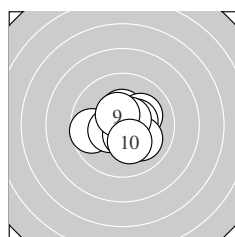
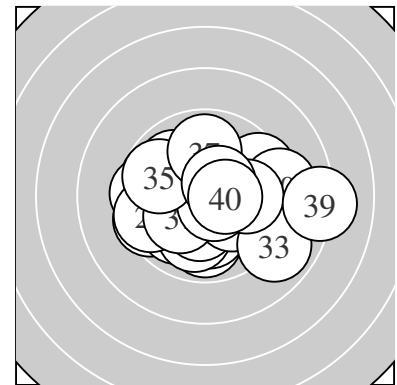

Serie 1:
 9.7 ← 10.4 * 10.1 ↗ 10.4 * 10.4 *
 10.6 * 10.1 ↘ 10.6 * 10.5 * 10.2 *
 beste Teiler 88.4 (8.) 97.5 (6.) 117.6 (9.)
 Trefferlage 0.15 mm rechts, 0.06 mm tief
 Streuwert 1.32, horizontal: 1.51, vertikal: 1.08

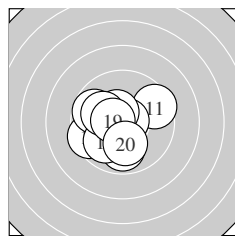

Serie 2:
 9.5 ↗ 9.5 ← 9.7 ↖ 9.9 ↓ 9.9 ↘
 10.8 * 10.5 * 10.1 ↖ 10.6 * 10.1 ↓
 beste Teiler 45.5 (16.) 100.4 (19.) 118.7 (17.)
 Trefferlage 0.75 mm links, 0.32 mm tief
 Streuwert 1.74, horizontal: 1.90, vertikal: 1.56

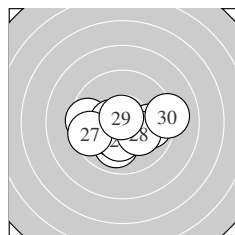

Serie 3:
 10.0 ↓ 10.3 * 9.8 → 9.5 ← 10.5 *
 10.3 * 9.6 ← 10.2 * 10.8 * 9.1 →
 beste Teiler 48.7 (29.) 109.0 (25.) 156.7 (22.)
 Trefferlage 0.10 mm links, 0.67 mm tief
 Streuwert 1.90, horizontal: 2.50, vertikal: 1.00

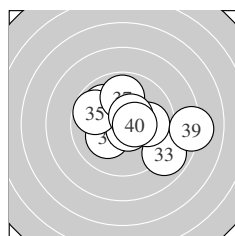

Serie 4:
 10.2 * 9.9 ↖ 8.9 ↘ 10.7 * 9.7 ↖
 9.9 → 9.9 ↑ 10.5 * 8.2 → 10.5 *
 beste Teiler 73.6 (34.) 114.5 (38.) 122.1 (40.)
 Trefferlage 1.00 mm rechts, 0.12 mm hoch
 Streuwert 2.37, horizontal: 2.95, vertikal: 1.60

Unterschrift des Schützen

Ergebnis: **373** (391.1)
 Serien: 92 93 92 96
 Zähler: 18 17 5 0 0 0 0 0 0 0
 Innenzehner: 11
 weiteste: 722 (39), 615 (8), 556 (27)
 beste Teiler 41.7 (31.) 67.4 (38.) 69.1 (32.)
 Trefferlage 0.28 mm rechts, 0.51 mm hoch
 Streuwert 2.34, horizontal: 2.80, vertikal: 1.78

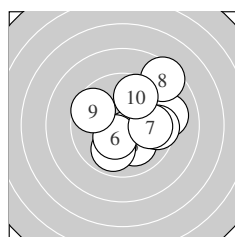
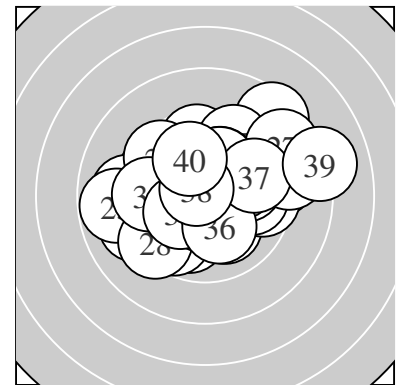

Serie 1:
 9.1 → 10.6 * 10.1 ↘ 9.6 → 9.9 ↘
 10.4 * 9.8 → 8.5 ↗ 9.6 ↖ 9.7 ↗
 beste Teiler 94.8 (2.) 141.1 (6.) 222.1 (3.)
 Trefferlage 1.30 mm rechts, 0.33 mm hoch
 Streuwert 2.31, horizontal: 2.42, vertikal: 2.20

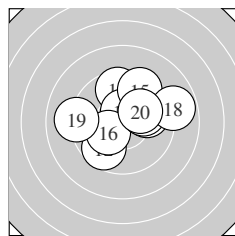

Serie 2:
 9.9 → 9.7 ↘ 9.6 ↑ 10.5 * 9.5 ↗
 10.2 * 10.0 → 8.8 → 9.1 ← 10.1 ↗
 beste Teiler 108.0 (14.) 179.6 (16.) 210.6 (20.)
 Trefferlage 0.47 mm rechts, 0.83 mm hoch
 Streuwert 2.31, horizontal: 2.75, vertikal: 1.77

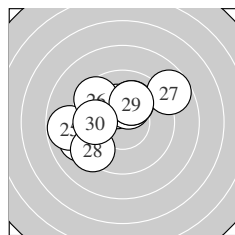

Serie 3:
 10.3 * 9.1 ← 10.3 * 10.1 ↗ 8.8 ←
 9.5 ↖ 8.7 ↗ 9.3 ↘ 10.1 ↗ 9.8 ←
 beste Teiler 164.5 (23.) 167.6 (21.) 212.1 (29.)
 Trefferlage 1.15 mm links, 0.72 mm hoch
 Streuwert 2.52, horizontal: 3.00, vertikal: 1.91

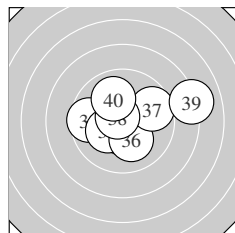

Serie 4:
 10.8 * 10.7 * 9.6 ← 10.5 * 10.2 *
 10.1 ↘ 9.7 → 10.7 * 8.1 → 10.0 ↘
 beste Teiler 41.7 (31.) 67.4 (38.) 69.1 (32.)
 Trefferlage 0.50 mm rechts, 0.15 mm hoch
 Streuwert 2.20, horizontal: 2.81, vertikal: 1.34

Unterschrift des Schützen

Meyton Elektronik

Ergebnis: **376** (396.7)

Serien: 95 93 95 93

Zähler: 19 18 3 0 0 0 0 0 0 0

Innenzehner: 15

weiteste: 626 (27), 546 (10), 537 (14)

beste Teiler 29.1 (21.) 36.0 (19.) 59.0 (22.)

Trefferlage 0.35 mm rechts, 0.63 mm hoch

Streuwert 2.05, horizontal: 2.11, vertikal: 1.99

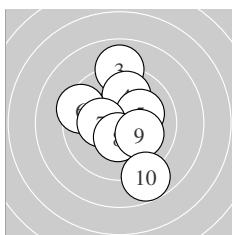
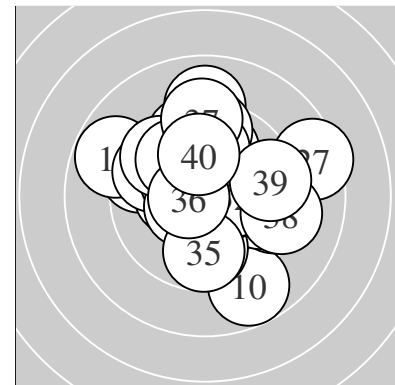

Serie 1:

10.3 *	10.1 ↑	9.0 ↑	9.9 ↑	10.1 ↗
9.4 ↖	10.3 *	10.4 *	10.1 ↘	8.8 ↘

beste Teiler 129.9 (8.) 167.0 (7.) 170.2 (1.)

Trefferlage 0.24 mm rechts, 0.61 mm hoch

Streuwert 2.26, horizontal: 1.78, vertikal: 2.64

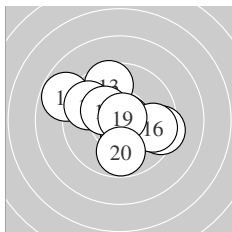

Serie 2:

10.3 *	10.7 *	9.6 ↑	8.8 ↖	9.4 →
9.7 →	9.7 ↖	10.3 *	10.8 *	9.8 ↓

beste Teiler 36.0 (19.) 60.0 (12.) 161.1 (18.)

Trefferlage 0.18 mm links, 0.17 mm hoch

Streuwert 2.23, horizontal: 2.57, vertikal: 1.82

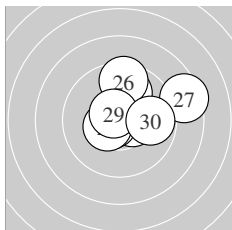

Serie 3:

10.8 *	10.7 *	10.5 *	10.6 *	9.9 ↑
9.5 ↑	8.4 →	10.4 *	10.6 *	9.8 →

beste Teiler 29.1 (21.) 59.0 (22.) 77.4 (24.)

Trefferlage 0.95 mm rechts, 0.75 mm hoch

Streuwert 1.78, horizontal: 2.07, vertikal: 1.43

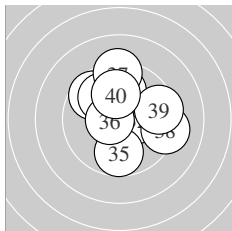

Serie 4:

9.6 ↖	10.3 *	9.9 ↑	9.9 ↖	9.7 ↓
10.6 *	9.3 ↑	9.2 →	9.5 →	10.0 ↑

beste Teiler 90.4 (36.) 159.0 (32.) 231.6 (40.)

Trefferlage 0.41 mm rechts, 1.00 mm hoch

Streuwert 2.11, horizontal: 2.14, vertikal: 2.09

Unterschrift des Schützen

Meyton Elektronik

Ergebnis:	360	(378.4)
Serien:	89 88 92 91	
Zähler:	13 16 9 2 0 0 0 0 0 0	
Innenzehner:	9	
weiteste:	867 (20), 834 (4), 708 (37)	
beste Teiler	26.6 (40.) 63.1 (31.) 107.9 (30.)	
Trefferlage	0.43 mm rechts, 0.62 mm tief	
Streuwert	3.01, horizontal: 3.57, vertikal: 2.32	

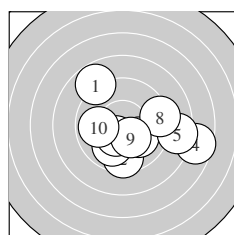
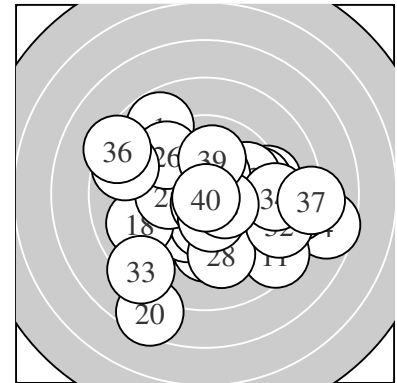

Serie 1:	8.8 ↖	9.5 ↓	10.1 ↘	7.6 →	8.5 →
	9.9 ↙	10.4 *	9.2 →	10.3 *	9.9 ←
beste Teiler	140.4 (7.)	164.4 (9.)	223.6 (3.)		
Trefferlage	1.35 mm rechts, 0.75 mm tief				
Streuwert	3.05, horizontal: 3.70, vertikal: 2.22				

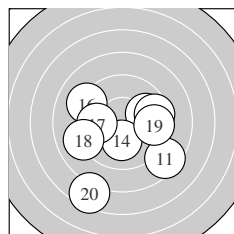

Serie 2:	8.5 ↘	9.9 →	9.8 ←	10.1 ↓	9.5 →
	9.2 ↖	9.8 ←	9.0 ←	9.5 →	7.5 ↙
beste Teiler	202.2 (14.)	273.0 (12.)	286.3 (17.)		
Trefferlage	0.36 mm links, 1.25 mm tief				
Streuwert	3.28, horizontal: 3.61, vertikal: 2.91				

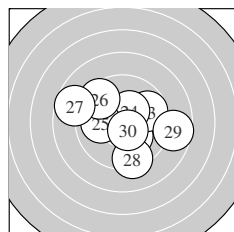

Serie 3:	9.6 ↖	10.2 *	9.7 →	10.4 *	10.0 ←
	9.5 ↖	8.7 ↖	9.3 ↓	8.7 →	10.5 *
beste Teiler	107.9 (30.)	145.4 (24.)	191.8 (22.)		
Trefferlage	0.13 mm links, 0.08 mm hoch				
Streuwert	2.66, horizontal: 3.20, vertikal: 1.98				

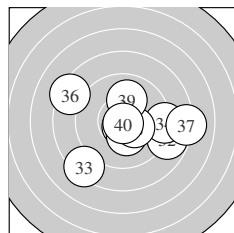

Serie 4:	10.7 *	8.8 →	8.3 ↙	9.1 →	10.3 *
	8.3 ↖	8.1 →	10.4 *	10.0 ↑	10.8 *
beste Teiler	26.6 (40.)	63.1 (31.)	149.8 (38.)		
Trefferlage	0.88 mm rechts, 0.55 mm tief				
Streuwert	3.23, horizontal: 3.99, vertikal: 2.22				

Unterschrift des Schützen

Ergebnis: **377** (392.9)
 Serien: 95 92 98 92
 Zähler: 19 19 2 0 0 0 0 0 0 0
 Innenzehner: 12
 weiteste: 528 (19), 515 (17), 485 (34)
 beste Teiler 77.7 (31.) 88.5 (36.) 93.9 (28.)
 Trefferlage 0.32 mm rechts, 0.22 mm tief
 Streuwert 2.18, horizontal: 2.25, vertikal: 2.11

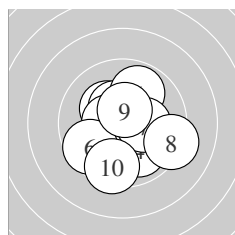
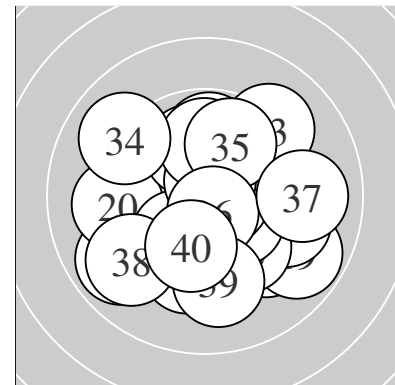

Serie 1:
 10.2 * 10.4 * 10.5 * 9.9 ↘ 9.9 ↗
 9.6 ↙ 10.3 * 9.2 ↘ 10.5 * 9.5 ↓
 beste Teiler 109.3 (9.) 110.4 (3.) 135.9 (2.)
 Trefferlage 0.19 mm rechts, 0.32 mm tief
 Streuwert 1.90, horizontal: 1.91, vertikal: 1.89

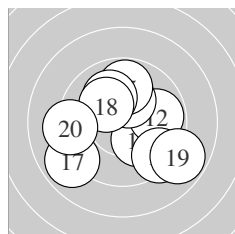

Serie 2:
 10.2 * 9.8 → 9.3 ↘ 10.2 * 9.8 ↑
 10.0 ↘ 8.9 ↙ 10.2 * 8.8 ↘ 9.2 ←
 beste Teiler 183.3 (14.) 191.0 (11.) 195.2 (18.)
 Trefferlage 0.13 mm rechts, 0.19 mm tief
 Streuwert 2.59, horizontal: 2.92, vertikal: 2.21

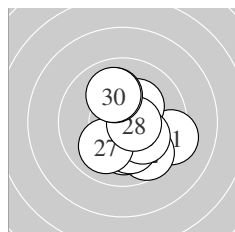

Serie 3:
 9.3 ↘ 9.7 ↘ 10.1 ↓ 10.3 * 10.1 ↓
 10.1 ↘ 10.0 ↙ 10.6 * 10.0 ↑ 10.0 ↑
 beste Teiler 93.9 (28.) 174.2 (24.) 202.0 (26.)
 Trefferlage 0.76 mm rechts, 0.53 mm tief
 Streuwert 1.69, horizontal: 1.56, vertikal: 1.82

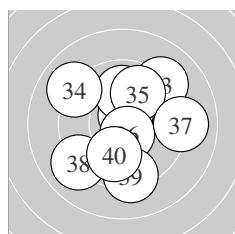

Serie 4:
 10.6 * 9.9 ↑ 9.2 ↗ 9.0 ↘ 9.8 ↗
 10.6 * 9.0 → 9.0 ↙ 9.3 ↓ 9.9 ↓
 beste Teiler 77.7 (31.) 88.5 (36.) 255.0 (32.)
 Trefferlage 0.21 mm rechts, 0.13 mm hoch
 Streuwert 2.68, horizontal: 2.65, vertikal: 2.71

Unterschrift des Schützen

Meyton Elektronik

Ergebnis: **388** (404.8)
 Serien: 97 96 97 98
 Zähler: 29 10 1 0 0 0 0 0 0 0
 Innenzehner: 21
 weiteste: 569 (17), 469 (7), 434 (9)
 beste Teiler 48.0 (2.) 50.5 (27.) 62.1 (25.)
 Trefferlage 0.14 mm rechts, 0.42 mm hoch
 Streuwert 1.71, horizontal: 2.04, vertikal: 1.31

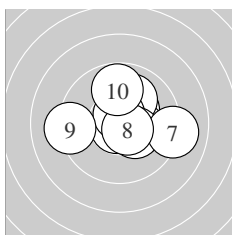
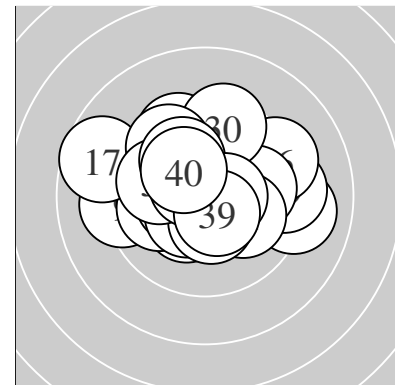

Serie 1:
 10.3 * 10.8 * 10.2 * 10.0 ↗ 10.7 *
 10.3 * 9.1 → 10.6 * 9.2 ← 9.8 ↑
 beste Teiler 48.0 (2.) 74.2 (5.) 87.0 (8.)
 Trefferlage 0.58 mm rechts, 0.34 mm hoch
 Streuwert 1.83, horizontal: 2.23, vertikal: 1.31

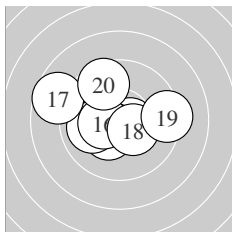

Serie 2:
 10.6 * 10.6 * 10.3 * 10.0 ↖ 10.0 ←
 10.4 * 8.7 ↖ 10.4 * 9.3 → 9.6 ↘
 beste Teiler 95.6 (12.) 95.8 (11.) 141.4 (16.)
 Trefferlage 0.80 mm links, 0.25 mm hoch
 Streuwert 2.03, horizontal: 2.52, vertikal: 1.39

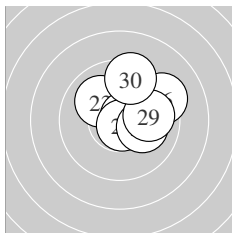

Serie 3:
 10.6 * 10.0 ↗ 10.0 ↖ 10.5 * 10.7 *
 9.3 ↗ 10.8 * 10.1 → 9.9 → 9.5 ↑
 beste Teiler 50.5 (27.) 62.1 (25.) 87.2 (21.)
 Trefferlage 1.20 mm rechts, 0.80 mm hoch
 Streuwert 1.37, horizontal: 1.44, vertikal: 1.30

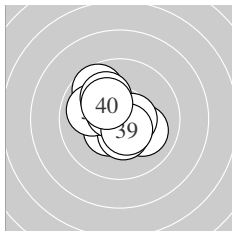

Serie 4:
 10.1 ↘ 10.4 * 10.4 * 9.7 ↘ 9.9 ↖
 10.6 * 10.1 ↘ 10.5 * 10.5 * 10.3 *
 beste Teiler 90.6 (36.) 102.0 (38.) 108.4 (39.)
 Trefferlage 0.42 mm links, 0.29 mm hoch
 Streuwert 1.36, horizontal: 1.37, vertikal: 1.34

Unterschrift des Schützen

Meyton Elektronik

Ergebnis: **387** (403.3)
 Serien: 96 99 95 97
 Zähler: 29 9 2 0 0 0 0 0 0 0
 Innenzehner: 22
 weiteste: 618 (30), 591 (2), 386 (35)
 beste Teiler 72.5 (17.) 72.6 (33.) 98.5 (1.)
 Trefferlage 0.41 mm links, 0.22 mm tief
 Streuwert 1.75, horizontal: 2.16, vertikal: 1.20

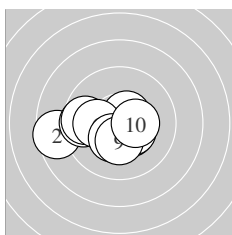
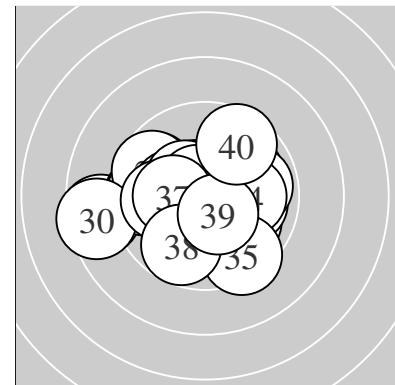

Serie 1:
 10.6 * 8.6 ← 9.6 ← 9.7 ← 10.4 *
 10.1 ← 10.4 * 10.3 * 10.3 * 10.4 *
 beste Teiler 98.5 (1.) 132.3 (5.) 136.7 (7.)
 Trefferlage 1.09 mm links, 0.46 mm tief
 Streuwert 1.80, horizontal: 2.43, vertikal: 0.78

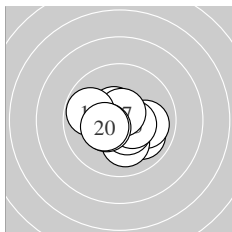

Serie 2:
 10.0 ↘ 10.0 → 10.1 ↓ 10.5 * 10.5 *
 10.5 * 10.7 * 9.8 ← 10.4 * 10.3 *
 beste Teiler 72.5 (17.) 101.8 (16.) 120.4 (14.)
 Trefferlage 0.11 mm rechts, 0.42 mm tief
 Streuwert 1.32, horizontal: 1.59, vertikal: 0.97

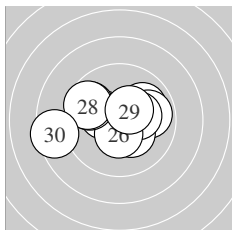

Serie 3:
 10.0 ↗ 9.9 → 10.3 * 10.3 * 10.3 *
 10.4 * 9.7 ↖ 9.6 ↖ 10.4 * 8.5 ←
 beste Teiler 128.3 (26.) 130.8 (29.) 155.2 (25.)
 Trefferlage 0.49 mm links, 0.25 mm hoch
 Streuwert 2.11, horizontal: 2.77, vertikal: 1.10

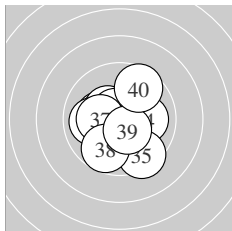

Serie 4:
 10.2 * 10.4 * 10.7 * 10.0 → 9.4 ↘
 10.0 ← 10.2 * 9.7 ↓ 10.5 * 9.6 ↗
 beste Teiler 72.6 (33.) 124.8 (39.) 139.8 (32.)
 Trefferlage 0.20 mm links, 0.26 mm tief
 Streuwert 1.77, horizontal: 1.77, vertikal: 1.77

Unterschrift des Schützen

Meyton Elektronik

Ergebnis: **392** (410.4)
 Serien: 98 98 99 97
 Zähler: 33 6 1 0 0 0 0 0 0 0
 Innenzehner: 27
 weiteste: 515 (18), 447 (9), 379 (2)
 beste Teiler 26.0 (21.) 35.8 (40.) 68.0 (38.)
 Trefferlage 0.38 mm rechts, 0.50 mm tief
 Streuwert 1.38, horizontal: 1.37, vertikal: 1.39

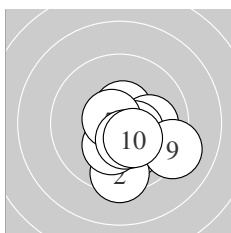
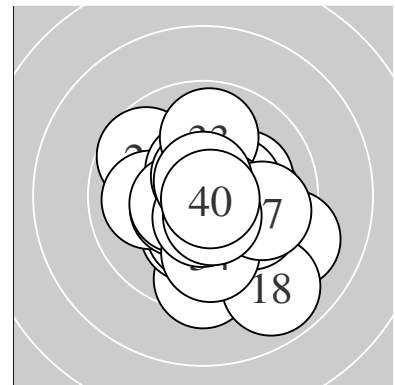

Serie 1:
 10.1 ↘ 9.4 ↓ 10.2 * 10.6 * 10.1 →
 10.5 * 10.7 * 10.4 * 9.2 ↘ 10.3 *
 beste Teiler 68.8 (7.) 99.9 (4.) 122.5 (6.)
 Trefferlage 0.87 mm rechts, 1.10 mm tief
 Streuwert 1.38, horizontal: 1.40, vertikal: 1.36

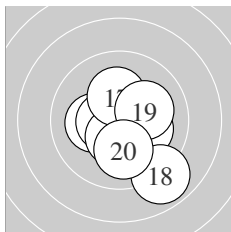

Serie 2:
 10.7 * 10.2 * 10.5 * 10.4 * 10.4 *
 10.2 * 10.2 * 8.9 ↘ 10.1 → 10.1 ↓
 beste Teiler 72.6 (11.) 108.6 (13.) 131.3 (15.)
 Trefferlage 0.42 mm rechts, 0.80 mm tief
 Streuwert 1.56, horizontal: 1.49, vertikal: 1.62

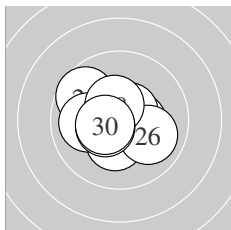

Serie 3:
 10.8 * 10.4 * 10.3 * 9.7 ↘ 10.6 *
 10.0 ↘ 10.0 ← 10.5 * 10.5 * 10.5 *
 beste Teiler 26.0 (21.) 91.3 (25.) 116.6 (30.)
 Trefferlage 0.37 mm links, 0.01 mm tief
 Streuwert 1.29, horizontal: 1.51, vertikal: 1.02

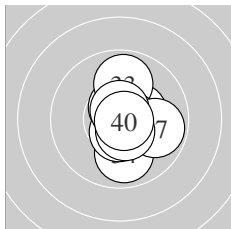

Serie 4:
 10.6 * 10.4 * 9.9 ↑ 9.9 ↓ 10.6 *
 10.6 * 9.8 ↘ 10.7 * 10.6 * 10.8 *
 beste Teiler 35.8 (40.) 68.0 (38.) 90.9 (31.)
 Trefferlage 0.61 mm rechts, 0.08 mm tief
 Streuwert 1.16, horizontal: 0.86, vertikal: 1.40

Unterschrift des Schützen

Ergebnis: **377** (396.8)
 Serien: 93 97 95 92
 Zähler: 20 17 3 0 0 0 0 0 0 0
 Innenzehner: 17
 weiteste: 677 (9), 541 (38), 512 (24)
 beste Teiler 23.4 (4.) 30.0 (13.) 72.4 (21.)
 Trefferlage 0.73 mm links, 0.61 mm hoch
 Streuwert 2.00, horizontal: 2.51, vertikal: 1.30

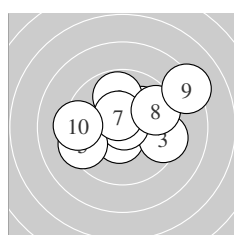
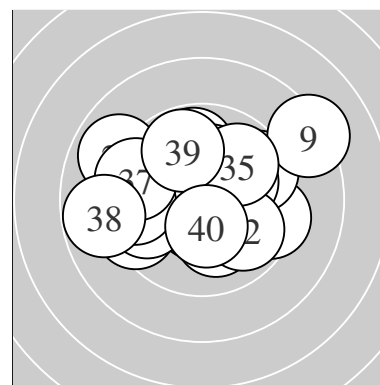

Serie 1:
 10.5 * 10.1 ↗ 9.4 → 10.9 * 9.4 ←
 9.8 ↑ 10.5 * 9.6 ↗ 8.2 ↗ 9.3 ←
 beste Teiler 23.4 (4.) 108.2 (1.) 110.1 (7.)
 Trefferlage 0.55 mm rechts, 0.70 mm hoch
 Streuwert 2.49, horizontal: 3.10, vertikal: 1.66

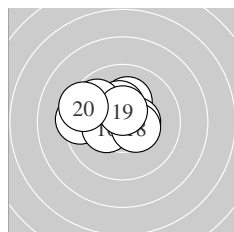

Serie 2:
 10.2 * 10.3 * 10.8 * 9.8 ↘ 9.4 ←
 10.3 * 10.5 * 10.4 * 10.5 * 9.4 ↘
 beste Teiler 30.0 (13.) 105.0 (19.) 121.0 (17.)
 Trefferlage 0.83 mm links, 0.66 mm hoch
 Streuwert 1.48, horizontal: 1.87, vertikal: 0.93

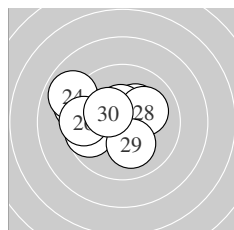

Serie 3:
 10.7 * 10.3 * 9.2 ↘ 8.9 ↘ 9.7 ←
 9.5 ← 10.5 * 10.1 ↗ 10.1 ↓ 10.3 *
 beste Teiler 72.4 (21.) 118.3 (27.) 158.1 (30.)
 Trefferlage 1.23 mm links, 0.60 mm hoch
 Streuwert 1.89, horizontal: 2.36, vertikal: 1.26

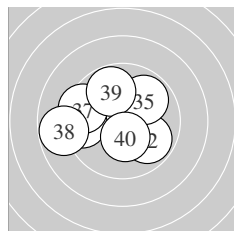

Serie 4:
 10.4 * 9.9 ↘ 9.8 ↘ 10.3 * 9.9 ↗
 9.5 ← 9.4 ← 8.8 ← 9.8 ↑ 10.4 *
 beste Teiler 138.2 (31.) 145.9 (40.) 175.8 (34.)
 Trefferlage 1.40 mm links, 0.49 mm hoch
 Streuwert 2.02, horizontal: 2.46, vertikal: 1.46

Unterschrift des Schützen

Meyton Elektronik

Ergebnis: **382** (401.2)
 Serien: 95 96 97 94
 Zähler: 22 18 0 0 0 0 0 0 0 0
 Innenzehner: 17
 weiteste: 465 (8), 456 (26), 445 (14)
 beste Teiler 69.1 (28.) 71.5 (4.) 83.1 (22.)
 Trefferlage 0.21 mm links, 0.39 mm hoch
 Streuwert 1.81, horizontal: 2.15, vertikal: 1.38

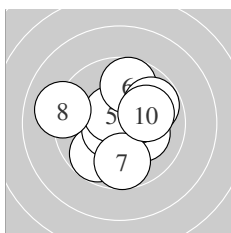
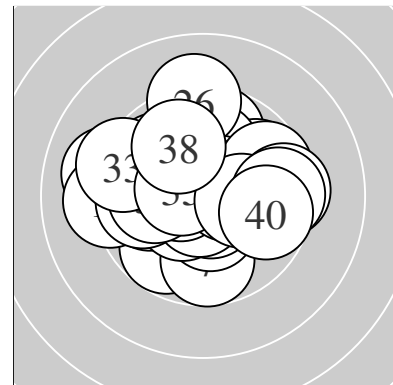

Serie 1:
 9.8 ↘ 10.2 * 10.6 * 10.7 * 10.6 *
 9.7 ↑ 9.7 ↓ 9.1 ← 9.8 ↗ 10.1 →
 beste Teiler 71.5 (4.) 94.6 (3.) 96.4 (5.)
 Trefferlage 0.01 mm rechts, 0.07 mm hoch
 Streuwert 1.96, horizontal: 2.09, vertikal: 1.82

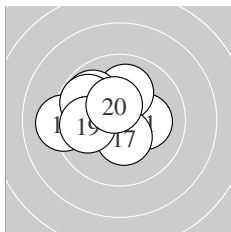

Serie 2:
 10.2 * 10.1 ↑ 10.0 ↖ 9.2 ← 9.8 ↖
 10.1 ← 10.4 * 9.8 ↖ 9.9 ← 10.4 *
 beste Teiler 128.4 (20.) 139.4 (17.) 196.3 (11.)
 Trefferlage 1.34 mm links, 0.56 mm hoch
 Streuwert 1.56, horizontal: 1.89, vertikal: 1.14

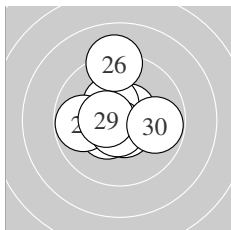

Serie 3:
 10.4 * 10.6 * 10.5 * 10.6 * 10.4 *
 9.1 ↑ 9.8 ← 10.7 * 10.5 * 9.8 →
 beste Teiler 69.1 (28.) 83.1 (22.) 93.3 (24.)
 Trefferlage 0.31 mm links, 0.45 mm hoch
 Streuwert 1.54, horizontal: 1.46, vertikal: 1.61

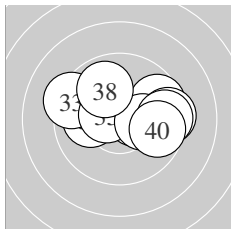

Serie 4:
 10.5 * 10.0 ← 9.3 ↖ 9.6 ↗ 10.5 *
 9.4 → 10.2 * 9.9 ↘ 9.5 → 9.7 →
 beste Teiler 108.7 (35.) 120.2 (31.) 185.4 (37.)
 Trefferlage 0.81 mm rechts, 0.48 mm hoch
 Streuwert 2.03, horizontal: 2.72, vertikal: 0.94

Unterschrift des Schützen

Meyton Elektronik

Ergebnis: **389** (405.1)
 Serien: 97 96 98 98
 Zähler: 29 11 0 0 0 0 0 0 0 0
 Innenzehner: 24
 weiteste: 410 (11), 391 (23), 385 (6)
 beste Teiler 31.7 (39.) 43.3 (16.) 54.5 (25.)
 Trefferlage 0.83 mm rechts, 0.32 mm hoch
 Streuwert 1.54, horizontal: 1.52, vertikal: 1.55

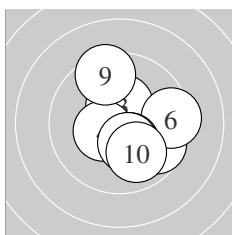
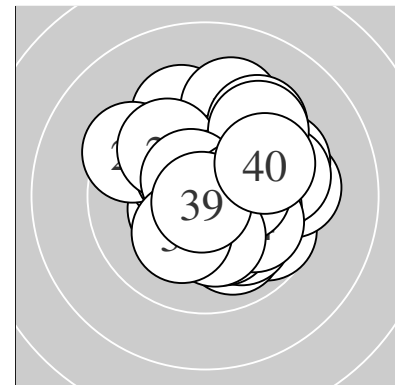

Serie 1:
 10.3 * 10.4 * 10.4 * 10.4 * 9.7 ↘
 9.4 → 10.3 * 10.3 * 9.5 ↑ 10.0 ↘
 beste Teiler 134.1 (4.) 135.7 (2.) 138.2 (3.)
 Trefferlage 0.83 mm rechts, 0.07 mm tief
 Streuwert 1.68, horizontal: 1.59, vertikal: 1.77

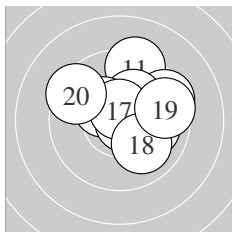

Serie 2:
 9.3 ↑ 10.0 → 9.5 ↗ 10.2 * 10.3 *
 10.8 * 10.6 * 10.0 ↘ 9.6 → 9.4 ↖
 beste Teiler 43.3 (16.) 80.0 (17.) 154.9 (15.)
 Trefferlage 0.87 mm rechts, 0.92 mm hoch
 Streuwert 1.80, horizontal: 2.03, vertikal: 1.54

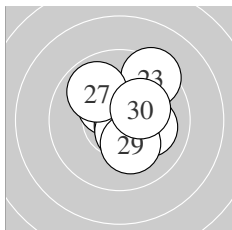

Serie 3:
 10.3 * 10.4 * 9.4 ↗ 10.2 * 10.7 *
 10.6 * 9.9 ↖ 10.1 → 10.2 * 10.3 *
 beste Teiler 54.5 (25.) 91.2 (26.) 142.2 (22.)
 Trefferlage 0.81 mm rechts, 0.42 mm hoch
 Streuwert 1.39, horizontal: 1.30, vertikal: 1.47

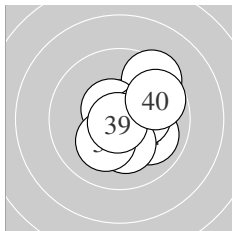

Serie 4:
 10.7 * 10.6 * 9.5 ↗ 10.0 ↘ 10.6 *
 10.3 * 10.2 * 10.2 * 10.8 * 9.7 ↗
 beste Teiler 31.7 (39.) 66.9 (31.) 77.8 (32.)
 Trefferlage 0.81 mm rechts, 0.05 mm hoch
 Streuwert 1.38, horizontal: 1.31, vertikal: 1.46

Unterschrift des Schützen

Meyton Elektronik

Ergebnis: **356** (372.1)
 Serien: 93 81 94 88
 Zähler: 14 18 5 2 0 0 0 0 0 0
 Innenzehner: 9
 weiteste: 2809 (18), 870 (19), 752 (35)
 beste Teiler 48.7 (30.) 69.6 (37.) 98.4 (25.)
 Trefferlage 0.94 mm links, 0.46 mm tief
 Streuwert 4.18, horizontal: 3.29, vertikal: 4.91

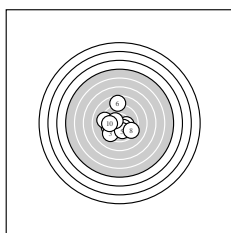
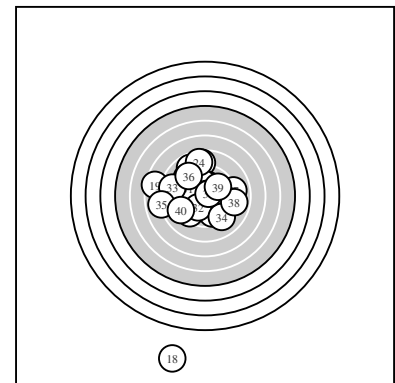

Serie 1:
 10.2 * 9.7 ← 9.4 ↙ 10.3 * 10.0 ↓
 8.7 ↑ 9.2 ← 9.4 ↘ 10.4 * 9.8 ←
 beste Teiler 143.6 (9.) 163.4 (4.) 191.4 (1.)
 Trefferlage 0.72 mm links, 0.28 mm tief
 Streuwert 2.42, horizontal: 2.44, vertikal: 2.41

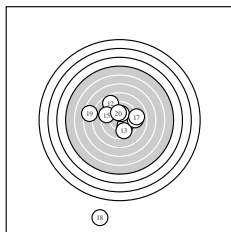

Serie 2:
 10.1 ↘ 8.8 ↖ 9.7 ↓ 9.2 → 9.4 ↖
 10.2 * 9.0 → 0.0 ↓ 7.5 ← 10.1 ↑
 beste Teiler 190.4 (16.) 212.5 (20.) 213.6 (11.)
 Trefferlage 0.81 mm links, 1.88 mm tief
 Streuwert 7.20, horizontal: 4.26, vertikal: 9.26

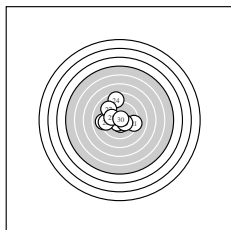

Serie 3:
 9.3 → 9.1 ← 10.5 * 8.6 ↑ 10.6 *
 9.4 ← 9.2 ↘ 10.0 ← 10.3 * 10.8 *
 beste Teiler 48.7 (30.) 98.4 (25.) 123.5 (23.)
 Trefferlage 0.91 mm links, 0.52 mm hoch
 Streuwert 2.43, horizontal: 2.63, vertikal: 2.23

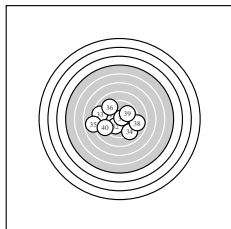

Serie 4:
 9.7 ↖ 10.0 ↙ 8.7 ← 9.1 ↓ 7.9 ←
 9.2 ↘ 10.7 * 8.9 → 9.9 ↗ 9.1 ←
 beste Teiler 69.6 (37.) 227.0 (32.) 267.4 (39.)
 Trefferlage 1.34 mm links, 0.23 mm tief
 Streuwert 3.18, horizontal: 3.94, vertikal: 2.18

Unterschrift des Schützen

Ergebnis: **379** (397.9)
 Serien: 95 94 95 95
 Zähler: 20 19 1 0 0 0 0 0 0 0
 Innenzehner: 16
 weiteste: 509 (23), 441 (32), 435 (20)
 beste Teiler 48.0 (26.) 80.4 (30.) 82.0 (12.)
 Trefferlage 0.08 mm rechts, 0.18 mm hoch
 Streuwert 2.01, horizontal: 2.25, vertikal: 1.74

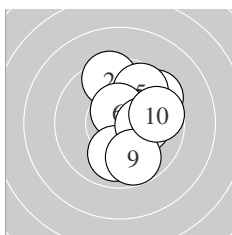
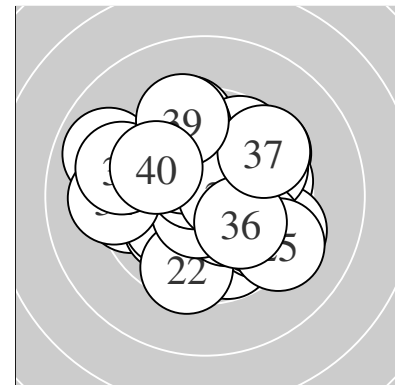

Serie 1:
 9.5 ↗ 9.5 ↑ 10.4 * 10.4 * 9.7 ↗
 10.6 * 10.0 ↓ 10.2 * 9.8 ↓ 9.7 →
 beste Teiler 99.7 (6.) 126.3 (4.) 135.2 (3.)
 Trefferlage 1.14 mm rechts, 0.38 mm hoch
 Streuwert 1.72, horizontal: 1.29, vertikal: 2.07

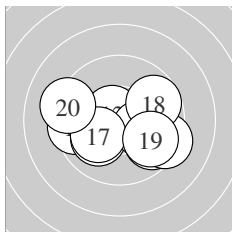

Serie 2:
 9.7 ↘ 10.6 * 9.5 ← 9.3 ↘ 10.1 ↗
 10.3 * 10.1 ↖ 9.7 ↗ 9.8 ↘ 9.2 ←
 beste Teiler 82.0 (12.) 175.6 (16.) 209.4 (17.)
 Trefferlage 0.13 mm rechts, 0.56 mm tief
 Streuwert 2.19, horizontal: 2.85, vertikal: 1.20

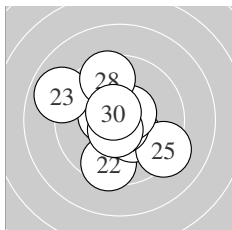

Serie 3:
 10.5 * 9.5 ↓ 8.9 ↖ 10.3 * 9.2 ↘
 10.8 * 10.6 * 9.6 ↑ 10.6 * 10.6 *
 beste Teiler 48.0 (26.) 80.4 (30.) 84.5 (29.)
 Trefferlage 0.30 mm links, 0.13 mm tief
 Streuwert 2.03, horizontal: 2.07, vertikal: 1.99

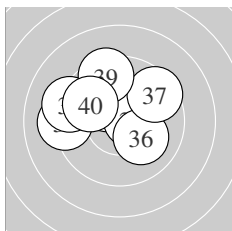

Serie 4:
 10.4 * 9.2 ← 10.5 * 10.3 * 10.6 *
 10.1 ↘ 9.5 ↗ 9.3 ↖ 9.4 ↑ 9.9 ↖
 beste Teiler 93.6 (35.) 103.7 (33.) 140.4 (31.)
 Trefferlage 0.61 mm links, 1.06 mm hoch
 Streuwert 1.96, horizontal: 2.42, vertikal: 1.34

Unterschrift des Schützen

Meyton Elektronik

Ergebnis: **391** (407.7)
 Serien: 99 99 97 96
 Zähler: 31 9 0 0 0 0 0 0 0 0
 Innenzehner: 23
 weiteste: 495 (40), 380 (39), 362 (27)
 beste Teiler 33.2 (23.) 50.3 (22.) 62.6 (28.)
 Trefferlage 0.17 mm links, 0.39 mm hoch
 Streuwert 1.50, horizontal: 1.43, vertikal: 1.57

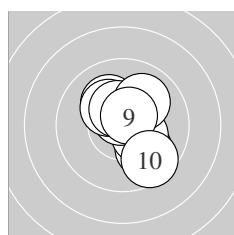
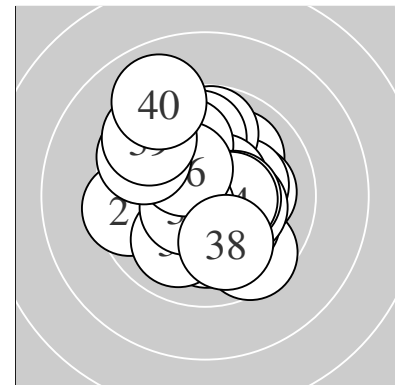

Serie 1:
 10.0 ↘ 10.1 ↖ 10.3 * 10.7 * 10.2 *
 10.5 * 10.4 * 10.0 ↗ 10.6 * 9.6 ↘
 beste Teiler 67.9 (4.) 90.1 (9.) 111.0 (6.)
 Trefferlage 0.49 mm rechts, 0.32 mm hoch
 Streuwert 1.38, horizontal: 1.16, vertikal: 1.57

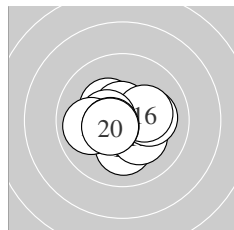

Serie 2:
 10.1 ↓ 10.2 * 10.3 * 10.6 * 10.1 →
 10.2 * 10.5 * 9.9 ← 10.5 * 10.5 *
 beste Teiler 81.7 (14.) 105.5 (19.) 111.3 (20.)
 Trefferlage 0.17 mm links, 0.20 mm tief
 Streuwert 1.25, horizontal: 1.48, vertikal: 0.97

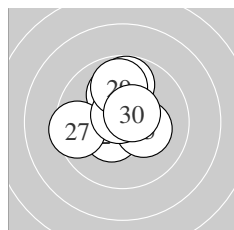

Serie 3:
 10.1 ↖ 10.8 * 10.8 * 10.5 * 10.3 *
 9.8 ↑ 9.5 ← 10.7 * 9.8 ↑ 10.5 *
 beste Teiler 33.2 (23.) 50.3 (22.) 62.6 (28.)
 Trefferlage 0.21 mm links, 0.71 mm hoch
 Streuwert 1.40, horizontal: 1.39, vertikal: 1.42

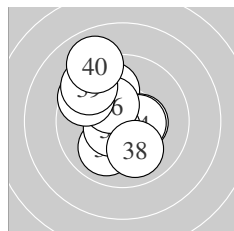

Serie 4:
 9.9 ↖ 10.4 * 10.0 ↙ 10.5 * 10.5 *
 10.3 * 9.6 ↘ 10.0 ↓ 9.4 ↘ 9.0 ↖
 beste Teiler 101.2 (35.) 120.0 (34.) 135.4 (32.)
 Trefferlage 0.81 mm links, 0.76 mm hoch
 Streuwert 1.88, horizontal: 1.55, vertikal: 2.16

Unterschrift des Schützen

Meyton Elektronik

Ergebnis:	384	(405.5)
Serien:	97 96 97 94	
Zähler:	24 16 0 0 0 0 0 0 0 0	
Innenzehner:	23	
weiteste:	463 (37), 431 (18), 404 (28)	
beste Teiler	24.3 (11.) 38.0 (9.) 58.1 (15.)	
Trefferlage	1.06 mm rechts, 0.12 mm hoch	
Streuwert	1.48, horizontal: 1.71, vertikal: 1.20	

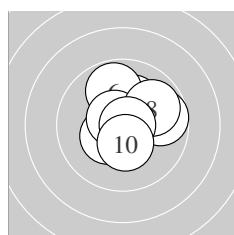
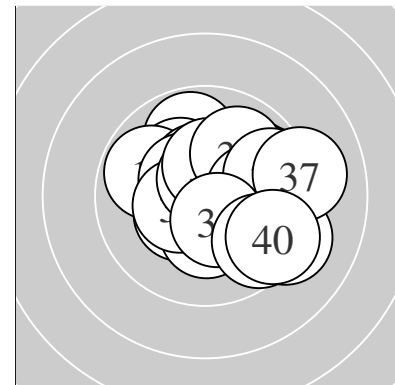

Serie 1:	10.2 *	10.7 *	10.6 *	10.4 *	9.7 →
	9.8 ↑	10.6 *	9.9 ↗	10.8 *	10.4 *
beste Teiler	38.0 (9.)	68.1 (2.)	83.0 (7.)		
Trefferlage	0.45 mm rechts, 0.45 mm hoch				
Streuwert	1.30, horizontal: 1.35, vertikal: 1.24				

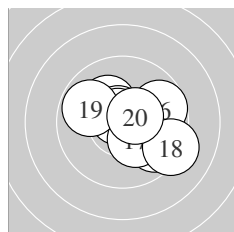

Serie 2:	10.9 *	9.7 ↘	10.2 *	10.7 *	10.7 *
	9.7 ↗	10.3 *	9.2 ↘	9.8 ↖	10.5 *
beste Teiler	24.3 (11.)	58.1 (15.)	74.3 (14.)		
Trefferlage	0.70 mm rechts, 0.02 mm hoch				
Streuwert	1.65, horizontal: 1.97, vertikal: 1.26				

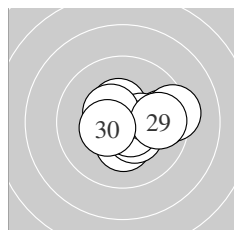

Serie 3:	9.7 →	10.4 *	10.4 *	10.3 *	10.4 *
	10.6 *	10.5 *	9.3 →	9.8 →	10.4 *
beste Teiler	81.8 (26.)	120.7 (27.)	126.3 (22.)		
Trefferlage	1.05 mm rechts, 0.05 mm tief				
Streuwert	1.40, horizontal: 1.77, vertikal: 0.88				

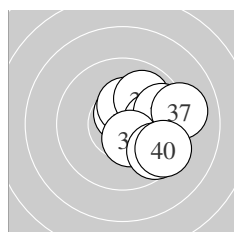

Serie 4:	10.6 *	10.4 *	9.9 ↗	10.0 →	9.9 →
	9.6 →	9.1 →	10.4 *	9.6 ↘	9.4 ↘
beste Teiler	82.2 (31.)	129.2 (38.)	148.3 (32.)		
Trefferlage	2.05 mm rechts, 0.05 mm hoch				
Streuwert	1.47, horizontal: 1.47, vertikal: 1.47				

Unterschrift des Schützen

Ergebnis:	382	(401.9)
Serien:	95 96 97 94	
Zähler:	23 16 1 0 0 0 0 0 0 0	
Innenzehner:	19	
weiteste:	550 (29), 484 (16), 473 (15)	
beste Teiler	58.8 (23.) 61.4 (14.) 69.8 (11.)	
Trefferlage	0.20 mm rechts, 0.12 mm hoch	
Streuwert	1.86, horizontal: 1.88, vertikal: 1.84	

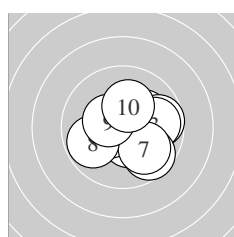
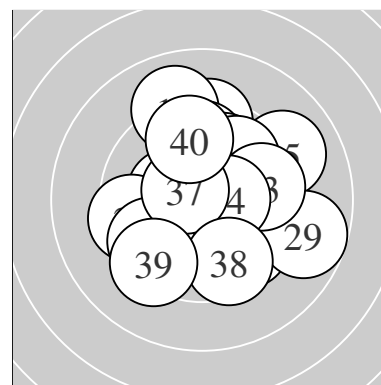

Serie 1:	10.1 ↗	9.7 →	9.9 →	10.4 *	9.7 ↘
	10.5 *	9.9 ↘	9.8 ↙	10.4 *	10.2 *
beste Teiler	115.1 (6.) 131.9 (9.) 133.0 (4.)				
Trefferlage	0.78 mm rechts, 0.27 mm tief				
Streuwert	1.62, horizontal: 1.88, vertikal: 1.32				

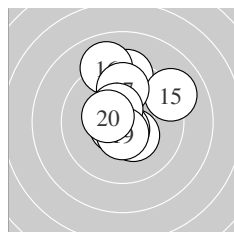

Serie 2:	10.7 *	9.4 ↑	10.4 *	10.7 *	9.1 ↗
	9.0 ↑	9.8 ↑	10.5 *	10.6 *	10.4 *
beste Teiler	61.4 (14.) 69.8 (11.) 97.0 (19.)				
Trefferlage	0.17 mm rechts, 1.23 mm hoch				
Streuwert	1.85, horizontal: 1.56, vertikal: 2.11				

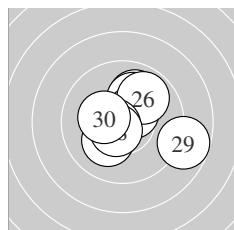

Serie 3:	10.0 ↗	10.1 ↗	10.7 *	10.5 *	10.2 *
	9.9 ↗	10.7 *	10.6 *	8.8 →	10.3 *
beste Teiler	58.8 (23.) 74.3 (27.) 89.6 (28.)				
Trefferlage	0.50 mm rechts, 0.33 mm hoch				
Streuwert	1.74, horizontal: 1.99, vertikal: 1.46				

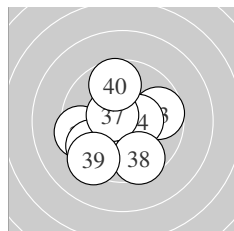

Serie 4:	10.5 *	10.0 ↘	9.7 →	10.4 *	9.5 ←
	9.6 ↙	10.6 *	9.6 ↘	9.3 ↙	9.7 ↑
beste Teiler	100.8 (37.) 122.4 (31.) 126.0 (34.)				
Trefferlage	0.64 mm links, 0.81 mm tief				
Streuwert	2.01, horizontal: 2.05, vertikal: 1.97				

Unterschrift des Schützen

Meyton Elektronik

Ergebnis:	388	(406.7)
Serien:	96 98 98 96	
Zähler:	28 12 0 0 0 0 0 0 0 0	
Innenzehner:	23	
weiteste:	474 (19), 403 (4), 379 (28)	
beste Teiler	8.0 (10.) 34.0 (23.) 48.2 (26.)	
Trefferlage	0.36 mm rechts, 0.89 mm hoch	
Streuwert	1.42, horizontal: 1.59, vertikal: 1.24	

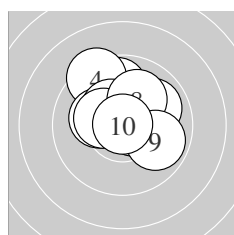
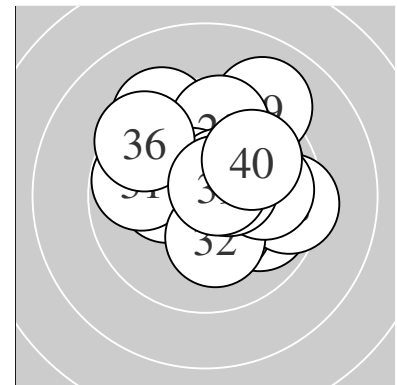

Serie 1:	9.8 ↑	10.6 *	9.9 ↗	9.3 ↘	10.2 *
	10.4 *	10.3 *	10.1 ↗	9.9 ↘	10.9 *
beste Teiler	8.0 (10.)	85.3 (2.)	147.6 (6.)		
Trefferlage	0.01 mm rechts, 1.06 mm hoch				
Streuwert	1.49, horizontal: 1.58, vertikal: 1.40				

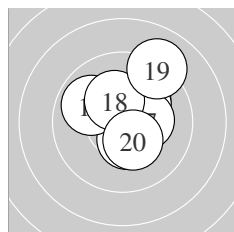

Serie 2:	10.4 *	10.5 *	10.1 ↗	10.4 *	10.2 *
	9.9 ↘	10.3 *	10.3 *	9.1 ↗	10.3 *
beste Teiler	124.1 (12.)	129.6 (11.)	132.9 (14.)		
Trefferlage	0.39 mm rechts, 0.96 mm hoch				
Streuwert	1.49, horizontal: 1.44, vertikal: 1.54				

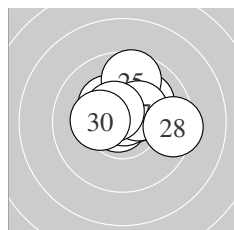

Serie 3:	10.1 ↗	10.3 *	10.8 *	10.4 *	9.7 ↑
	10.8 *	10.4 *	9.4 →	10.5 *	10.3 *
beste Teiler	34.0 (23.)	48.2 (26.)	102.6 (29.)		
Trefferlage	0.47 mm rechts, 0.86 mm hoch				
Streuwert	1.31, horizontal: 1.58, vertikal: 0.98				

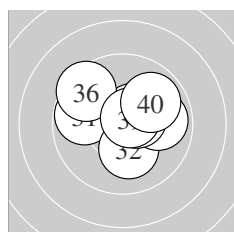

Serie 4:	9.8 ↖	10.2 *	10.1 ↗	10.0 ↗	10.5 *
	9.5 ↘	9.9 →	10.5 *	10.7 *	9.9 ↗
beste Teiler	75.4 (39.)	111.0 (35.)	114.7 (38.)		
Trefferlage	0.59 mm rechts, 0.70 mm hoch				
Streuwert	1.57, horizontal: 1.92, vertikal: 1.12				

Unterschrift des Schützen

Ergebnis: **381** (401.9)
 Serien: 95 97 96 93
 Zähler: 21 19 0 0 0 0 0 0 0 0
 Innenzehner: 18
 weiteste: 457 (40), 433 (10), 417 (15)
 beste Teiler 25.0 (6.) 80.6 (25.) 89.8 (9.)
 Trefferlage 0.02 mm rechts, 0.41 mm tief
 Streuwert 1.76, horizontal: 1.80, vertikal: 1.72

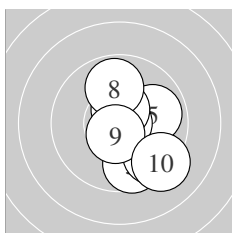
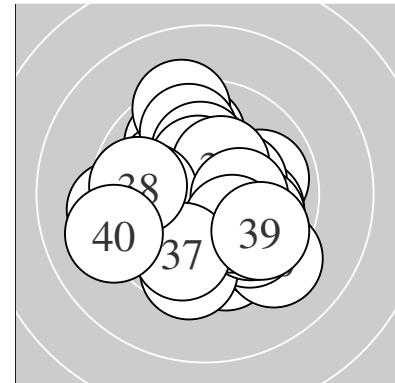

Serie 1:
 10.6 * 10.4 * 9.7 ↓ 9.6 ↘ 9.9 →
 10.9 * 10.5 * 9.9 ↑ 10.6 * 9.2 ↘
 beste Teiler 25.0 (6.) 89.8 (9.) 98.5 (1.)
 Trefferlage 0.94 mm rechts, 0.70 mm tief
 Streuwert 1.61, horizontal: 1.30, vertikal: 1.87

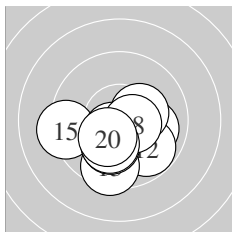

Serie 2:
 10.0 → 9.8 ↘ 9.5 ↓ 10.3 * 9.3 ←
 10.1 ↓ 10.5 * 10.5 * 10.2 * 10.3 *
 beste Teiler 101.2 (18.) 103.2 (17.) 159.2 (20.)
 Trefferlage 0.08 mm links, 1.25 mm tief
 Streuwert 1.56, horizontal: 1.89, vertikal: 1.13

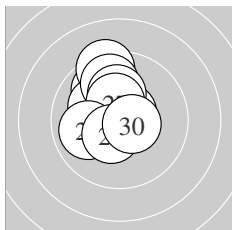

Serie 3:
 9.9 ↖ 10.1 ↖ 9.3 ↑ 9.8 ↑ 10.6 *
 10.2 * 10.4 * 9.9 ← 10.5 * 10.6 *
 beste Teiler 80.6 (25.) 97.7 (30.) 124.6 (29.)
 Trefferlage 0.71 mm links, 1.18 mm hoch
 Streuwert 1.35, horizontal: 1.02, vertikal: 1.62

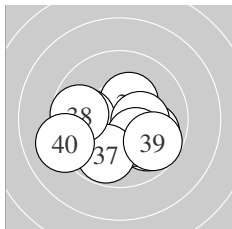

Serie 4:
 9.9 ↘ 9.9 ↘ 10.3 * 9.9 ← 10.3 *
 10.2 * 9.8 ↓ 9.7 ← 9.7 ↘ 9.1 ←
 beste Teiler 151.2 (33.) 158.6 (35.) 184.7 (36.)
 Trefferlage 0.04 mm links, 0.86 mm tief
 Streuwert 1.96, horizontal: 2.49, vertikal: 1.23

Unterschrift des Schützen

Meyton Elektronik

Ergebnis: **376** (392.5)
 Serien: 93 99 93 91
 Zähler: 19 18 3 0 0 0 0 0 0 0
 Innenzehner: 13
 weiteste: 701 (28), 616 (31), 544 (6)
 beste Teiler 59.9 (18.) 112.5 (39.) 117.1 (14.)
 Trefferlage 0.19 mm links, 0.54 mm hoch
 Streuwert 2.23, horizontal: 2.36, vertikal: 2.09

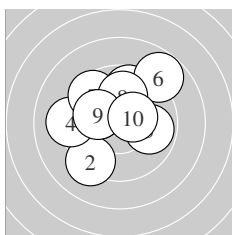
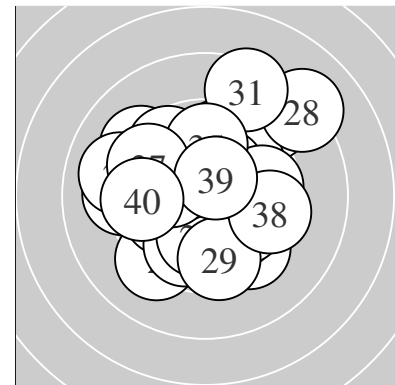

Serie 1:
 10.1 ↖ 9.2 ↙ 9.7 ↑ 9.2 ← 9.9 →
 8.8 ↗ 9.6 ↘ 10.0 ↑ 10.1 ↖ 10.4 *
 beste Teiler 131.0 (10.) 210.9 (9.) 211.3 (1.)
 Trefferlage 0.48 mm links, 1.04 mm hoch
 Streuwert 2.36, horizontal: 2.57, vertikal: 2.14

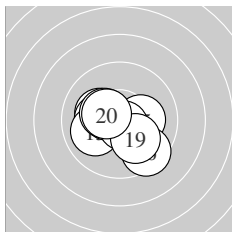

Serie 2:
 10.2 * 10.2 * 10.0 ↙ 10.5 * 10.2 *
 9.5 ↘ 10.3 * 10.7 * 10.1 ↘ 10.4 *
 beste Teiler 59.9 (18.) 117.1 (14.) 130.6 (20.)
 Trefferlage 0.34 mm links, 0.35 mm tief
 Streuwert 1.46, horizontal: 1.71, vertikal: 1.15

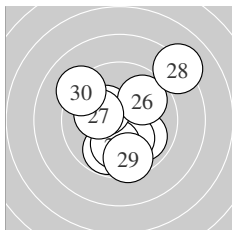

Serie 3:
 9.8 ↙ 9.9 ↘ 10.2 * 10.1 ↓ 10.3 *
 9.9 ↗ 10.2 * 8.1 ↗ 9.6 ↓ 9.2 ↘
 beste Teiler 153.2 (25.) 188.0 (23.) 196.5 (27.)
 Trefferlage 0.29 mm rechts, 0.07 mm tief
 Streuwert 2.54, horizontal: 2.48, vertikal: 2.60

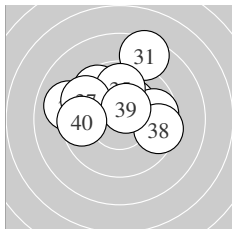

Serie 4:
 8.5 ↑ 9.6 ↘ 10.3 * 9.7 → 9.8 ↑
 9.0 ← 9.6 ↖ 9.5 → 10.5 * 9.6 ←
 beste Teiler 112.5 (39.) 170.8 (33.) 277.0 (35.)
 Trefferlage 0.26 mm links, 1.57 mm hoch
 Streuwert 2.41, horizontal: 2.86, vertikal: 1.85

Unterschrift des Schützen

Meyton Elektronik

Ergebnis: **386** (404.0)
 Serien: 95 98 96 97
 Zähler: 27 12 1 0 0 0 0 0 0 0
 Innenzehner: 19
 weiteste: 529 (4), 494 (26), 445 (27)
 beste Teiler 26.0 (29.) 40.7 (15.) 47.1 (7.)
 Trefferlage 0.72 mm rechts, 0.73 mm tief
 Streuwert 1.63, horizontal: 1.93, vertikal: 1.26

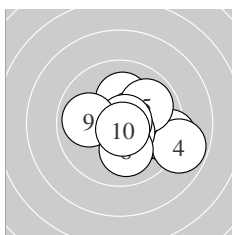
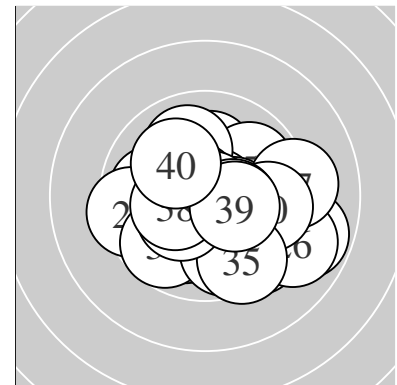

Serie 1:
 10.0 → 10.1 ↑ 9.2 → 8.8 → 9.9 ↗
 10.6 * 10.8 * 10.1 ↓ 9.9 ← 10.7 *
 beste Teiler 47.1 (7.) 55.9 (10.) 99.7 (6.)
 Trefferlage 1.31 mm rechts, 0.33 mm tief
 Streuwert 1.79, horizontal: 2.16, vertikal: 1.33

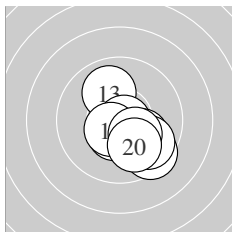

Serie 2:
 9.5 ↘ 10.7 * 10.0 ↖ 10.5 * 10.8 *
 10.5 * 10.1 ↘ 9.8 ↘ 10.3 * 10.0 ↓
 beste Teiler 40.7 (15.) 67.1 (12.) 104.7 (16.)
 Trefferlage 0.79 mm rechts, 0.94 mm tief
 Streuwert 1.30, horizontal: 1.25, vertikal: 1.35

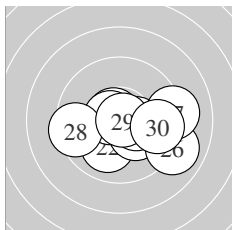

Serie 3:
 10.7 * 10.0 ↙ 10.3 * 10.6 * 10.4 *
 9.0 → 9.2 → 9.5 ← 10.8 * 9.7 →
 beste Teiler 26.0 (29.) 66.6 (21.) 79.5 (24.)
 Trefferlage 0.89 mm rechts, 0.59 mm tief
 Streuwert 1.95, horizontal: 2.57, vertikal: 1.01

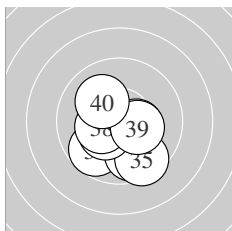

Serie 4:
 10.5 * 9.7 ↙ 9.8 ↓ 10.6 * 9.5 ↓
 10.4 * 10.3 * 10.3 * 10.3 * 10.1 ↘
 beste Teiler 87.8 (34.) 114.7 (31.) 143.9 (36.)
 Trefferlage 0.12 mm links, 1.08 mm tief
 Streuwert 1.41, horizontal: 1.43, vertikal: 1.38

Unterschrift des Schützen

Meyton Elektronik

Ergebnis:	367	(384.8)
Serien:	91 88 94 94	
Zähler:	18 12 9 1 0 0 0 0 0 0	
Innenzehner:	14	
weiteste:	802 (5), 723 (33), 684 (10)	
beste Teiler	29.0 (12.) 48.2 (9.) 73.8 (36.)	
Trefferlage	0.58 mm links, 0.11 mm hoch	
Streuwert	2.79, horizontal: 3.53, vertikal: 1.76	

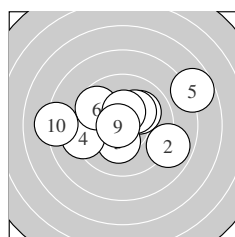
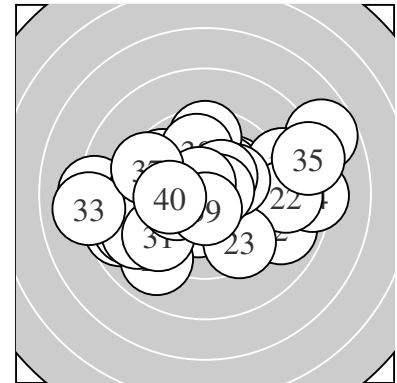

Serie 1:	10.1 ↗	8.9 ↘	10.3 *	9.3 ↙	7.7 ↘
	9.7 ↘	10.2 *	10.4 *	10.8 *	8.2 ↙
beste Teiler	48.2 (9.)	137.5 (8.)	171.9 (3.)		
Trefferlage	0.05 mm rechts, 0.45 mm hoch				
Streuwert	3.14, horizontal: 4.07, vertikal: 1.77				

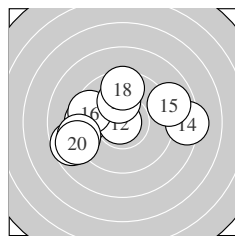

Serie 2:	9.5 ↙	10.8 *	8.7 ↙	8.3 →	8.9 →
	9.5 ↙	10.1 ↑	9.6 ↑	9.1 ↙	8.9 ↙
beste Teiler	29.0 (12.)	217.5 (17.)	350.0 (18.)		
Trefferlage	1.08 mm links, 0.27 mm hoch				
Streuwert	3.18, horizontal: 4.09, vertikal: 1.88				

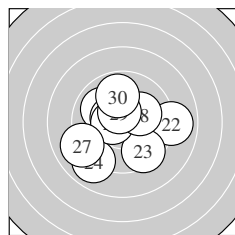

Serie 3:	10.0 ↘	8.9 →	9.5 ↘	9.0 ↙	10.5 *
	10.5 *	9.0 ↙	10.2 *	10.5 *	9.9 ↑
beste Teiler	104.1 (26.)	110.0 (29.)	119.7 (25.)		
Trefferlage	0.33 mm links, 0.31 mm tief				
Streuwert	2.42, horizontal: 2.69, vertikal: 2.12				

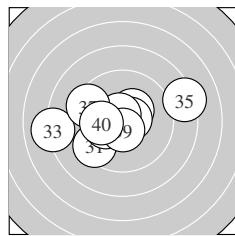

Serie 4:	9.4 ↙	10.4 *	8.1 ↙	10.6 *	8.3 →
	10.7 *	9.4 ↘	10.2 *	10.6 *	10.1 ↙
beste Teiler	73.8 (36.)	81.7 (34.)	92.0 (39.)		
Trefferlage	0.96 mm links, 0.05 mm hoch				
Streuwert	2.69, horizontal: 3.55, vertikal: 1.39				

Unterschrift des Schützen

Meyton Elektronik