

Ergebnis: **387** (408.8)
 Serien: 96 98 98 95
 Zähler: 27 13 0 0 0 0 0 0 0 0
 Innenzehner: 24
 weiteste: 394 (1), 373 (31), 339 (25)
 beste Teiler 37.0 (37.) 44.2 (10.) 46.3 (20.)
 Trefferlage 0.18 mm links, 0.27 mm hoch
 Streuwert 1.49, horizontal: 1.68, vertikal: 1.26

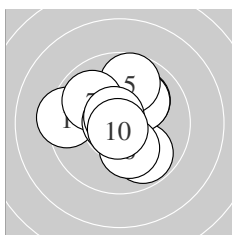

Serie 1:
 9.4 ← 9.8 ↘ 10.0 ↗ 10.1 ↗ 9.7 ↑
 10.2 * 9.9 ↖ 10.7 * 10.7 * 10.8 *
 beste Teiler 44.2 (10.) 54.7 (8.) 63.0 (9.)
 Trefferlage 0.08 mm links, 0.44 mm hoch
 Streuwert 1.71, horizontal: 1.78, vertikal: 1.63

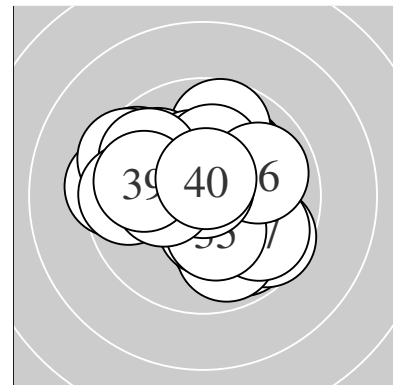
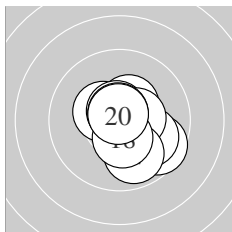

Serie 2:
 9.6 ↘ 10.0 ↘ 10.4 * 10.4 * 10.7 *
 10.5 * 9.9 ↓ 10.4 * 10.7 * 10.8 *
 beste Teiler 46.3 (20.) 53.3 (19.) 71.4 (15.)
 Trefferlage 0.64 mm rechts, 0.32 mm tief
 Streuwert 1.23, horizontal: 1.20, vertikal: 1.25

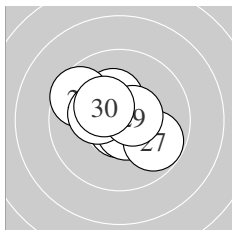

Serie 3:
 10.7 * 10.4 * 10.7 * 10.3 * 9.6 ↖
 10.6 * 9.8 ↘ 10.3 * 10.5 * 10.3 *
 beste Teiler 51.4 (21.) 54.5 (23.) 88.2 (26.)
 Trefferlage 0.30 mm links, 0.32 mm hoch
 Streuwert 1.31, horizontal: 1.53, vertikal: 1.03

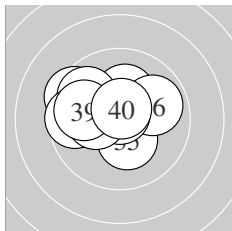

Serie 4:
 9.5 ↖ 10.2 * 9.8 ↖ 9.6 ← 10.3 *
 9.9 → 10.8 * 10.3 * 9.9 ← 10.6 *
 beste Teiler 37.0 (37.) 78.0 (40.) 162.3 (35.)
 Trefferlage 0.98 mm links, 0.64 mm hoch
 Streuwert 1.56, horizontal: 1.96, vertikal: 1.01

Unterschrift des Schützen

Meyton Elektronik

Ergebnis: **397** (414.4)
 Serien: 100 98 100 99
 Zähler: 38 1 1 0 0 0 0 0 0
 Innenzehner: 32
 weiteste: 558 (20), 284 (38), 234 (3)
 beste Teiler 25.0 (32.) 32.2 (6.) 41.1 (12.)
 Trefferlage 0.04 mm links, 0.35 mm hoch
 Streuwert 1.22, horizontal: 1.04, vertikal: 1.39

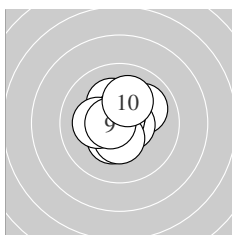
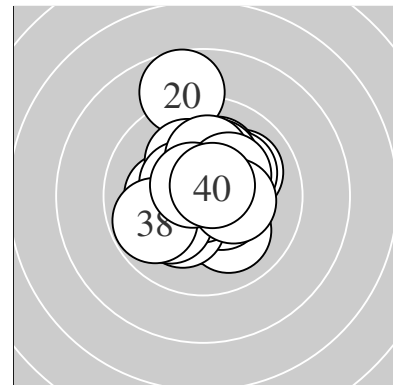

Serie 1:
 10.4 * 10.2 * 10.0 ↗ 10.6 * 10.7 *
 10.8 * 10.4 * 10.2 * 10.6 * 10.1 ↑
 beste Teiler 32.2 (6.) 74.1 (5.) 81.0 (9.)
 Trefferlage 0.05 mm links, 0.31 mm hoch
 Streuwert 1.10, horizontal: 1.07, vertikal: 1.13

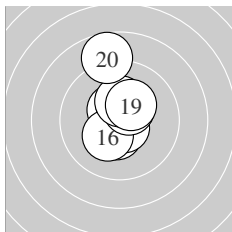

Serie 2:
 10.4 * 10.8 * 10.5 * 10.7 * 10.5 *
 10.3 * 10.5 * 10.3 * 10.3 * 8.7 ↑
 beste Teiler 41.1 (12.) 73.2 (14.) 109.2 (13.)
 Trefferlage 0.01 mm links, 0.83 mm hoch
 Streuwert 1.47, horizontal: 0.73, vertikal: 1.95

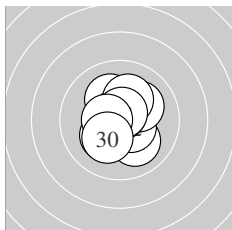

Serie 3:
 10.1 ↘ 10.5 * 10.1 ↗ 10.2 * 10.2 *
 10.8 * 10.2 * 10.7 * 10.5 * 10.2 *
 beste Teiler 50.2 (26.) 67.0 (28.) 111.0 (29.)
 Trefferlage 0.07 mm rechts, 0.07 mm hoch
 Streuwert 1.23, horizontal: 1.09, vertikal: 1.35

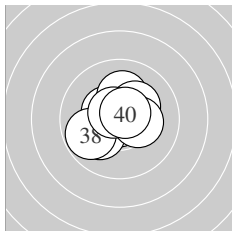

Serie 4:
 10.4 * 10.9 * 10.7 * 10.1 ↑ 10.1 ↙
 10.3 * 10.3 * 9.8 ↙ 10.6 * 10.7 *
 beste Teiler 25.0 (32.) 66.7 (33.) 73.6 (40.)
 Trefferlage 0.17 mm links, 0.19 mm hoch
 Streuwert 1.18, horizontal: 1.32, vertikal: 1.03

Unterschrift des Schützen

Meyton Elektronik

Ergebnis: **392** (409.5)
 Serien: 97 99 97 99
 Zähler: 32 8 0 0 0 0 0 0 0 0
 Innenzehner: 22
 weiteste: 320 (3), 292 (19), 282 (1)
 beste Teiler 17.0 (39.) 28.8 (40.) 56.9 (34.)
 Trefferlage 0.39 mm rechts, 0.05 mm hoch
 Streuwert 1.38, horizontal: 1.44, vertikal: 1.32

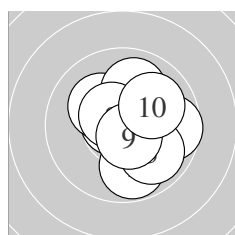
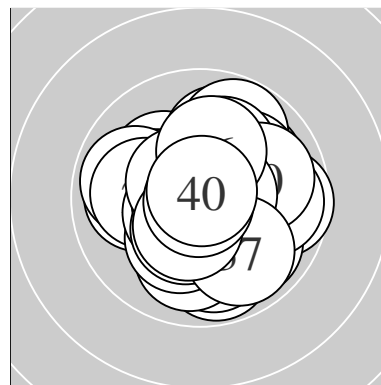

Serie 1:
 9.8 ↓ 10.7 * 9.7 → 10.6 * 9.9 ↘
 10.2 * 10.0 ↑ 10.6 * 10.6 * 10.0 ↗
 beste Teiler 64.8 (2.) 80.7 (4.) 86.0 (9.)
 Trefferlage 0.69 mm rechts, 0.05 mm hoch
 Streuwert 1.47, horizontal: 1.42, vertikal: 1.51

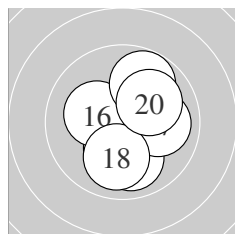

Serie 2:
 10.2 * 10.2 * 10.3 * 10.0 ↓ 10.1 ↗
 10.2 * 10.0 → 10.0 ↓ 9.8 ↑ 10.1 ↗
 beste Teiler 168.5 (13.) 179.7 (12.) 183.4 (16.)
 Trefferlage 0.86 mm rechts, 0.05 mm tief
 Streuwert 1.50, horizontal: 1.33, vertikal: 1.66

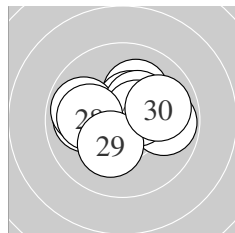

Serie 3:
 10.1 ↑ 9.8 → 10.5 * 10.0 ← 9.9 ←
 10.4 * 10.5 * 10.1 ← 10.2 * 9.9 →
 beste Teiler 107.7 (27.) 120.8 (23.) 150.8 (26.)
 Trefferlage 0.04 mm rechts, 0.45 mm hoch
 Streuwert 1.55, horizontal: 1.98, vertikal: 0.94

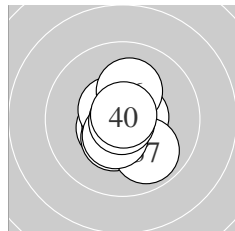

Serie 4:
 10.5 * 10.6 * 10.4 * 10.7 * 10.6 *
 10.2 * 9.9 ↘ 10.5 * 10.9 * 10.8 *
 beste Teiler 17.0 (39.) 28.8 (40.) 56.9 (34.)
 Trefferlage 0.03 mm links, 0.25 mm tief
 Streuwert 0.98, horizontal: 0.81, vertikal: 1.12

Unterschrift des Schützen

Meyton Elektronik

Ergebnis: **394** (411.0)
 Serien: 99 99 98 98
 Zähler: 34 6 0 0 0 0 0 0 0 0
 Innenzehner: 28
 weiteste: 387 (25), 317 (29), 314 (34)
 beste Teiler 34.5 (10.) 37.1 (26.) 62.4 (12.)
 Trefferlage 0.07 mm rechts, 0.07 mm tief
 Streuwert 1.34, horizontal: 1.51, vertikal: 1.14

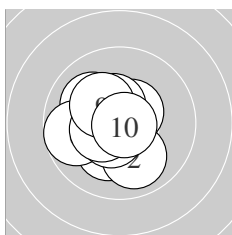
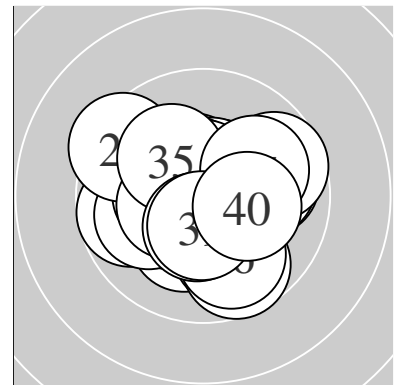

Serie 1:
 10.2 * 10.0 ↘ 10.5 * 10.1 ↖ 10.5 *
 9.7 ← 10.5 * 10.4 * 10.3 * 10.8 *
 beste Teiler 34.5 (10.) 101.2 (7.) 111.0 (3.)
 Trefferlage 0.69 mm links, 0.15 mm tief
 Streuwert 1.24, horizontal: 1.21, vertikal: 1.26

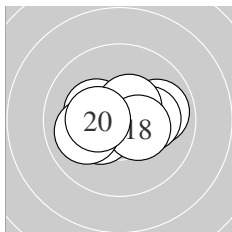

Serie 2:
 9.9 → 10.7 * 10.3 * 10.6 * 10.2 *
 10.5 * 10.3 * 10.4 * 10.0 ← 10.4 *
 beste Teiler 62.4 (12.) 95.7 (14.) 112.4 (16.)
 Trefferlage 0.01 mm rechts, 0.09 mm hoch
 Streuwert 1.26, horizontal: 1.67, vertikal: 0.60

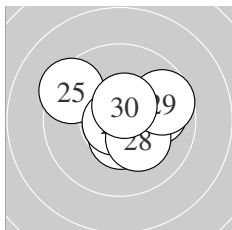

Serie 3:
 10.5 * 10.3 * 10.5 * 10.5 * 9.4 ↖
 10.8 * 10.0 → 10.2 * 9.7 → 10.5 *
 beste Teiler 37.1 (26.) 104.3 (30.) 104.8 (21.)
 Trefferlage 0.68 mm rechts, 0.15 mm hoch
 Streuwert 1.44, horizontal: 1.73, vertikal: 1.07

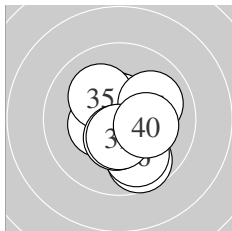

Serie 4:
 10.5 * 10.4 * 10.6 * 9.7 ↘ 10.1 ↖
 9.9 ↘ 10.0 → 10.4 * 10.5 * 10.2 *
 beste Teiler 90.0 (33.) 112.9 (31.) 123.1 (39.)
 Trefferlage 0.30 mm rechts, 0.39 mm tief
 Streuwert 1.39, horizontal: 1.24, vertikal: 1.53

Unterschrift des Schützen

Meyton Elektronik

Ergebnis: **381** (398.7)
 Serien: 99 91 96 95
 Zähler: 25 12 2 1 0 0 0 0 0 0
 Innenzehner: 21
 weiteste: 847 (15), 621 (16), 548 (25)
 beste Teiler 31.9 (32.) 38.2 (4.) 90.5 (40.)
 Trefferlage 0.26 mm rechts, 0.46 mm hoch
 Streuwert 2.08, horizontal: 2.37, vertikal: 1.74

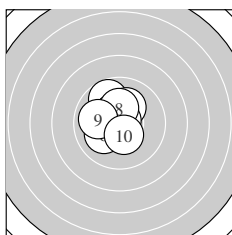
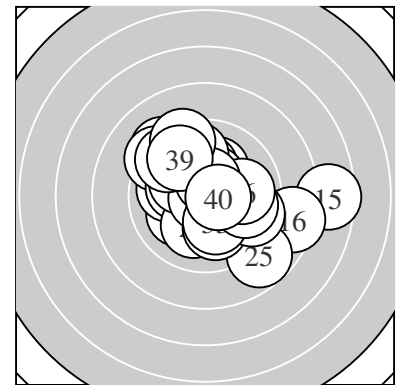

Serie 1:
 10.5 * 9.7 ↖ 10.2 * 10.8 * 10.5 *
 10.1 ↙ 10.4 * 10.3 * 10.0 ← 10.4 *
 beste Teiler 38.2 (4.) 124.2 (1.) 125.9 (5.)
 Trefferlage 0.59 mm links, 0.78 mm hoch
 Streuwert 1.16, horizontal: 1.03, vertikal: 1.29

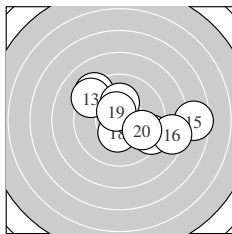

Serie 2:
 10.3 * 9.2 ↖ 9.3 ↖ 9.4 ↗ 7.6 →
 8.5 → 10.2 * 10.4 * 10.5 * 9.8 →
 beste Teiler 106.4 (19.) 142.0 (18.) 173.9 (11.)
 Trefferlage 1.33 mm rechts, 0.44 mm hoch
 Streuwert 2.98, horizontal: 3.79, vertikal: 1.85

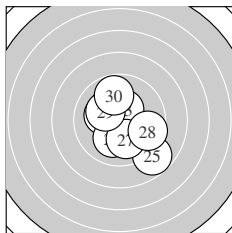

Serie 3:
 10.2 * 10.4 * 10.4 * 10.2 * 8.8 ↘
 10.1 ↓ 10.0 ↓ 9.6 ↗ 10.2 * 9.8 ↑
 beste Teiler 132.6 (23.) 141.5 (22.) 189.8 (29.)
 Trefferlage 0.13 mm rechts, 0.10 mm tief
 Streuwert 2.04, horizontal: 1.93, vertikal: 2.14

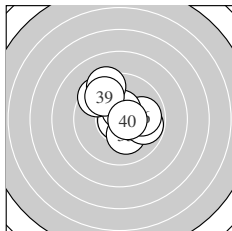

Serie 4:
 10.6 * 10.8 * 10.2 * 9.5 ↖ 9.8 →
 9.9 → 10.5 * 9.3 ↖ 9.7 ↖ 10.6 *
 beste Teiler 31.9 (32.) 90.5 (40.) 92.0 (31.)
 Trefferlage 0.18 mm rechts, 0.72 mm hoch
 Streuwert 1.74, horizontal: 1.76, vertikal: 1.72

Unterschrift des Schützen

Meyton Elektronik

Ergebnis: **383** (401.2)
 Serien: 95 94 97 97
 Zähler: 23 17 0 0 0 0 0 0 0 0
 Innenzehner: 17
 weiteste: 481 (24), 444 (17), 436 (27)
 beste Teiler 10.4 (34.) 47.5 (25.) 75.1 (28.)
 Trefferlage 0.44 mm links, 0.31 mm hoch
 Streuwert 1.81, horizontal: 1.99, vertikal: 1.61

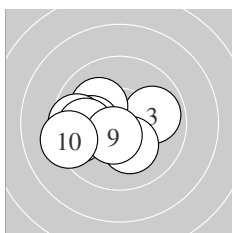
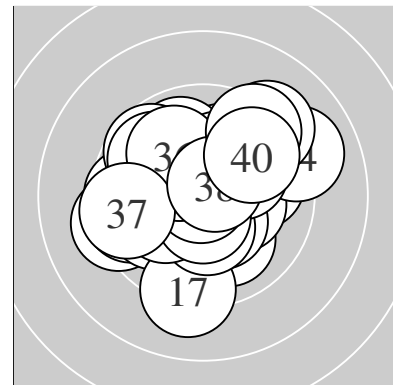

Serie 1:
 9.6 ← 10.5 * 9.9 → 10.1 ↘ 10.1 ←
 9.6 ← 10.2 * 9.9 ← 10.5 * 9.3 ←
 beste Teiler 107.3 (9.) 125.8 (2.) 188.7 (7.)
 Trefferlage 1.32 mm links, 0.40 mm tief
 Streuwert 1.67, horizontal: 2.18, vertikal: 0.92

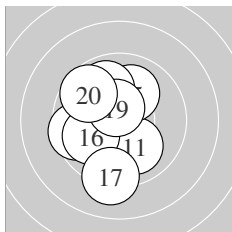

Serie 2:
 10.0 ↘ 9.6 ← 9.9 ↘ 10.2 * 10.0 ↗
 9.9 ← 9.2 ↓ 9.9 ↘ 10.6 * 9.7 ↘
 beste Teiler 100.0 (19.) 200.0 (14.) 227.1 (15.)
 Trefferlage 1.04 mm links, 0.29 mm hoch
 Streuwert 1.93, horizontal: 1.45, vertikal: 2.30

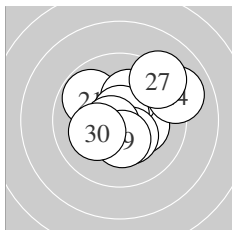

Serie 3:
 9.8 ↘ 10.3 * 10.2 * 9.0 → 10.8 *
 10.4 * 9.2 ↗ 10.7 * 10.4 * 10.2 *
 beste Teiler 47.5 (25.) 75.1 (28.) 145.0 (26.)
 Trefferlage 0.61 mm rechts, 0.47 mm hoch
 Streuwert 1.82, horizontal: 2.03, vertikal: 1.59

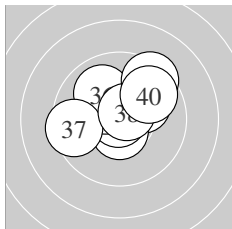

Serie 4:
 10.1 ↗ 10.3 * 10.6 * 10.9 * 10.3 *
 10.0 ↘ 9.5 ← 10.6 * 9.4 ↗ 9.8 ↗
 beste Teiler 10.4 (34.) 79.1 (38.) 93.0 (33.)
 Trefferlage 0.03 mm links, 0.90 mm hoch
 Streuwert 1.58, horizontal: 1.87, vertikal: 1.23

Unterschrift des Schützen

Ergebnis:	368	(387.9)
Serien:	88 95 94 91	
Zähler:	15 19 5 1 0 0 0 0 0 0	
Innenzehner:	12	
weiteste:	791 (1), 687 (10), 595 (39)	
beste Teiler	30.0 (20.) 38.2 (33.) 47.2 (7.)	
Trefferlage	0.33 mm rechts, 1.06 mm hoch	
Streuwert	2.46, horizontal: 3.12, vertikal: 1.53	

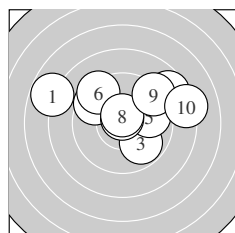
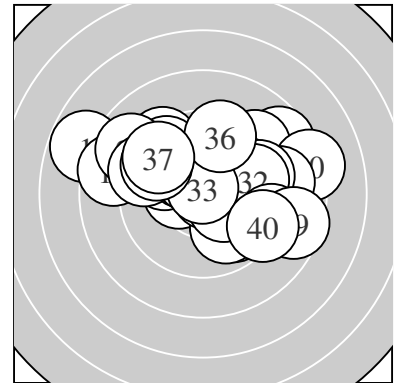

Serie 1:	7.8 ↖	8.7 ↗	9.8 ↘	9.5 ↖	9.8 →
	9.3 ↖	10.8 *	10.6 *	9.2 ↗	8.2 →
beste Teiler	47.2 (7.) 82.0 (8.) 278.7 (3.)				
Trefferlage	0.64 mm rechts, 1.62 mm hoch				
Streuwert	3.15, horizontal: 4.12, vertikal: 1.67				

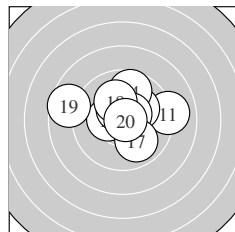

Serie 2:	9.0 →	10.2 *	10.3 *	9.7 ↑	10.5 *
	10.5 *	9.9 ↘	10.1 ↖	8.6 ↖	10.8 *
beste Teiler	30.0 (20.) 102.0 (16.) 118.5 (15.)				
Trefferlage	0.13 mm rechts, 0.81 mm hoch				
Streuwert	2.10, horizontal: 2.65, vertikal: 1.36				

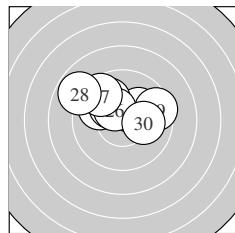

Serie 3:	10.4 *	10.1 ↗	9.9 ↖	10.2 *	9.9 ↖
	10.4 *	9.6 ↖	8.8 ↖	9.5 →	10.1 →
beste Teiler	134.8 (21.) 138.2 (26.) 186.0 (24.)				
Trefferlage	0.43 mm links, 1.41 mm hoch				
Streuwert	1.85, horizontal: 2.46, vertikal: 0.91				

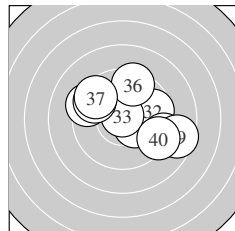

Serie 4:	10.4 *	9.6 →	10.8 *	9.4 ↖	9.6 ↖
	9.4 ↑	9.5 ↖	9.1 →	8.6 →	9.3 ↘
beste Teiler	38.2 (33.) 150.5 (31.) 326.0 (32.)				
Trefferlage	0.97 mm rechts, 0.42 mm hoch				
Streuwert	2.70, horizontal: 3.30, vertikal: 1.93				

Unterschrift des Schützen

Meyton Elektronik

Ergebnis: **380** (400.7)
 Serien: 92 95 95 98
 Zähler: 20 20 0 0 0 0 0 0 0 0
 Innenzehner: 14
 weiteste: 492 (8), 396 (7), 369 (35)
 beste Teiler 33.2 (36.) 51.9 (26.) 66.7 (3.)
 Trefferlage 0.09 mm links, 0.02 mm tief
 Streuwert 1.85, horizontal: 2.00, vertikal: 1.70

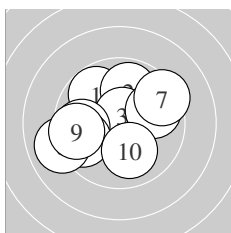
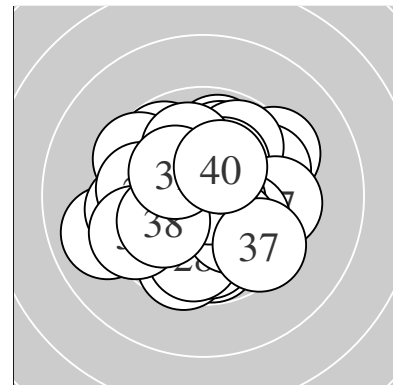

Serie 1:
 9.8 ↘ 9.9 ↑ 10.7 * 9.7 ← 9.8 →
 9.7 ← 9.4 ↗ 9.0 ← 9.5 ← 10.0 ↓
 beste Teiler 66.7 (3.) 232.8 (10.) 271.1 (2.)
 Trefferlage 0.80 mm links, 0.24 mm hoch
 Streuwert 2.30, horizontal: 2.75, vertikal: 1.74

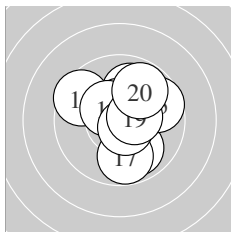

Serie 2:
 9.9 ↘ 10.0 ↑ 10.5 * 9.5 ↖ 9.7 →
 10.4 * 9.8 ↓ 10.7 * 10.5 * 9.8 ↗
 beste Teiler 75.2 (18.) 113.0 (13.) 123.2 (19.)
 Trefferlage 0.48 mm rechts, 0.43 mm hoch
 Streuwert 1.72, horizontal: 1.62, vertikal: 1.81

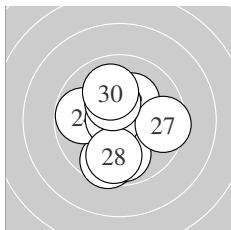

Serie 3:
 10.5 * 10.2 * 9.6 ↓ 9.8 ← 9.9 ↓
 10.7 * 9.6 → 9.8 ↓ 10.4 * 10.0 ↑
 beste Teiler 51.9 (26.) 118.5 (21.) 150.4 (29.)
 Trefferlage 0.24 mm links, 0.29 mm tief
 Streuwert 1.81, horizontal: 1.65, vertikal: 1.97

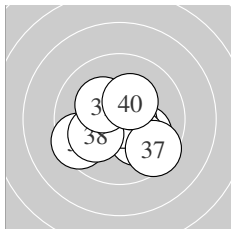

Serie 4:
 10.1 ↘ 10.6 * 10.6 * 10.1 ↘ 9.5 ←
 10.8 * 9.5 ↘ 10.1 ← 10.3 * 10.3 *
 beste Teiler 33.2 (36.) 80.6 (33.) 86.8 (32.)
 Trefferlage 0.18 mm rechts, 0.49 mm tief
 Streuwert 1.59, horizontal: 1.83, vertikal: 1.30

Unterschrift des Schützen

Meyton Elektronik

Ergebnis: **397** (418.1)
 Serien: 98 100 99 100
 Zähler: 37 3 0 0 0 0 0 0 0 0
 Innenzehner: 33
 weiteste: 300 (4), 289 (3), 271 (22)
 beste Teiler 8.0 (38.) 8.6 (2.) 38.3 (8.)
 Trefferlage 0.09 mm rechts, 0.04 mm hoch
 Streuwert 1.04, horizontal: 0.96, vertikal: 1.11

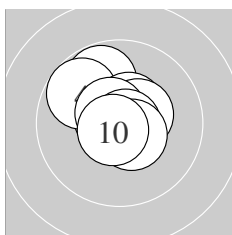
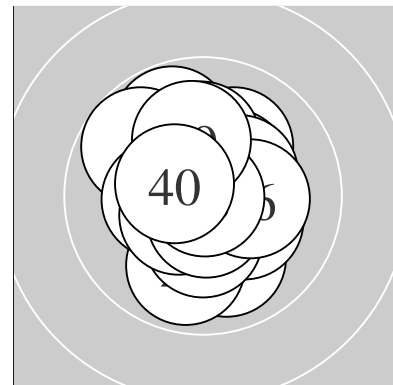

Serie 1:
 10.7 * 10.9 * 9.8 ↗ 9.8 ↘ 10.5 *
 10.4 * 10.6 * 10.8 * 10.5 * 10.7 *
 beste Teiler 8.6 (2.) 38.3 (8.) 60.1 (10.)
 Trefferlage 0.22 mm links, 0.56 mm hoch
 Streuwert 1.04, horizontal: 1.04, vertikal: 1.04

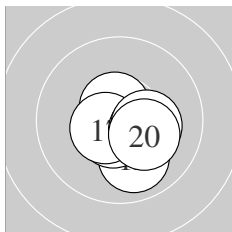

Serie 2:
 10.8 * 10.0 ↓ 10.6 * 10.6 * 10.6 *
 10.4 * 10.5 * 10.3 * 10.3 * 10.2 *
 beste Teiler 49.5 (11.) 80.9 (13.) 83.5 (15.)
 Trefferlage 0.44 mm rechts, 0.54 mm tief
 Streuwert 0.94, horizontal: 1.05, vertikal: 0.81

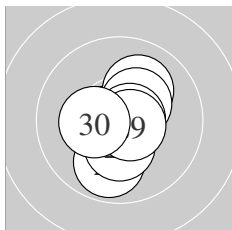

Serie 3:
 10.7 * 9.9 ↓ 10.7 * 10.1 ↗ 10.4 *
 10.7 * 10.7 * 10.3 * 10.7 * 10.3 *
 beste Teiler 61.8 (23.) 64.3 (27.) 72.4 (21.)
 Trefferlage 0.06 mm rechts, 0.29 mm tief
 Streuwert 1.08, horizontal: 0.88, vertikal: 1.25

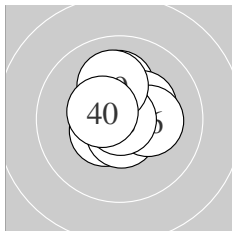

Serie 4:
 10.5 * 10.1 ↑ 10.7 * 10.6 * 10.3 *
 10.2 * 10.7 * 10.9 * 10.1 ↑ 10.5 *
 beste Teiler 8.0 (38.) 54.4 (33.) 63.1 (37.)
 Trefferlage 0.09 mm rechts, 0.46 mm hoch
 Streuwert 0.96, horizontal: 0.91, vertikal: 1.01

Unterschrift des Schützen

Meyton Elektronik

Ergebnis: **390** (410.3)
 Serien: 98 99 99 94
 Zähler: 30 10 0 0 0 0 0 0 0 0
 Innenzehner: 28
 weiteste: 411 (27), 366 (15), 303 (38)
 beste Teiler 10.2 (16.) 22.3 (14.) 32.0 (4.)
 Trefferlage 0.16 mm links, 0.08 mm hoch
 Streuwert 1.40, horizontal: 1.56, vertikal: 1.21

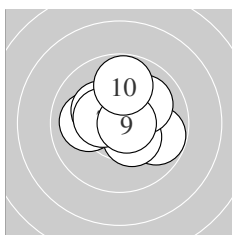
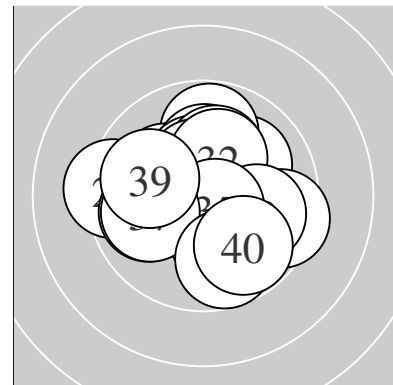

Serie 1:
 9.8 → 10.0 ← 10.3 * 10.8 * 10.6 *
 10.4 * 10.4 * 10.0 ↗ 10.7 * 9.8 ↑
 beste Teiler 32.0 (4.) 54.0 (9.) 88.8 (5.)
 Trefferlage 0.07 mm rechts, 0.45 mm hoch
 Streuwert 1.36, horizontal: 1.55, vertikal: 1.13

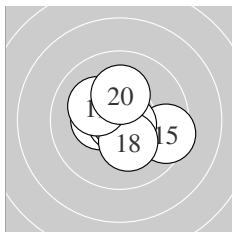

Serie 2:
 10.7 * 10.4 * 10.4 * 10.9 * 9.5 →
 10.9 * 10.7 * 10.3 * 10.2 * 10.2 *
 beste Teiler 10.2 (16.) 22.3 (14.) 62.0 (11.)
 Trefferlage 0.01 mm rechts, 0.01 mm tief
 Streuwert 1.27, horizontal: 1.49, vertikal: 1.01

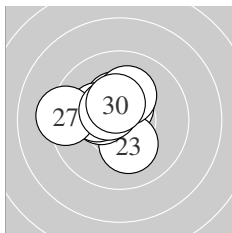

Serie 3:
 10.5 * 10.5 * 10.2 * 10.4 * 10.4 *
 10.2 * 9.3 ← 10.2 * 10.5 * 10.4 *
 beste Teiler 105.9 (21.) 111.2 (29.) 119.8 (22.)
 Trefferlage 0.81 mm links, 0.63 mm hoch
 Streuwert 1.22, horizontal: 1.41, vertikal: 0.99

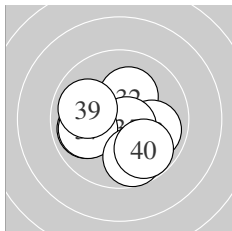

Serie 4:
 10.6 * 10.2 * 9.9 → 10.2 * 10.6 *
 9.9 ← 9.9 ← 9.7 ↓ 9.9 ← 9.8 ↓
 beste Teiler 77.7 (35.) 87.8 (31.) 181.3 (34.)
 Trefferlage 0.07 mm rechts, 0.72 mm tief
 Streuwert 1.61, horizontal: 1.83, vertikal: 1.35

Unterschrift des Schützen

Meyton Elektronik

Ergebnis: **396** (413.9)
 Serien: 100 100 98 98
 Zähler: 36 4 0 0 0 0 0 0 0 0
 Innenzehner: 33
 weiteste: 431 (35), 421 (21), 397 (25)
 beste Teiler 28.0 (8.) 35.2 (18.) 35.3 (16.)
 Trefferlage 0.00 mm , 0.31 mm hoch
 Streuwert 1.26, horizontal: 1.21, vertikal: 1.31

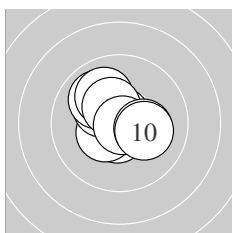
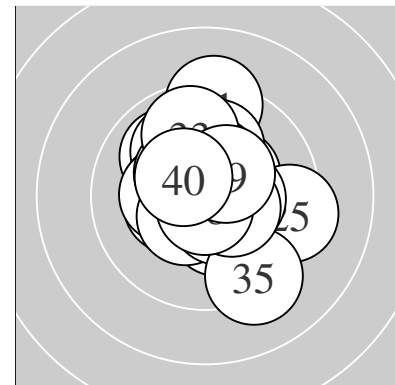

Serie 1:
 10.6 * 10.4 * 10.2 * 10.0 ↘ 10.7 *
 10.0 ↘ 10.4 * 10.8 * 10.2 * 10.2 *
 beste Teiler 28.0 (8.) 52.6 (5.) 82.9 (1.)
 Trefferlage 0.21 mm links, 0.41 mm hoch
 Streuwert 1.17, horizontal: 1.25, vertikal: 1.09

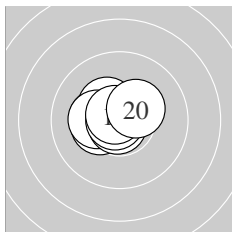

Serie 2:
 10.3 * 10.3 * 10.5 * 10.4 * 10.3 *
 10.8 * 10.8 * 10.8 * 10.7 * 10.3 *
 beste Teiler 35.2 (18.) 35.3 (16.) 39.8 (17.)
 Trefferlage 0.65 mm links, 0.22 mm hoch
 Streuwert 0.73, horizontal: 0.92, vertikal: 0.47

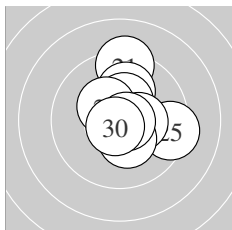

Serie 3:
 9.3 ↑ 10.1 ↑ 10.5 * 10.4 * 9.4 →
 10.4 * 10.4 * 10.3 * 10.7 * 10.7 *
 beste Teiler 51.1 (29.) 58.8 (30.) 105.0 (23.)
 Trefferlage 0.64 mm rechts, 0.69 mm hoch
 Streuwert 1.50, horizontal: 1.31, vertikal: 1.66

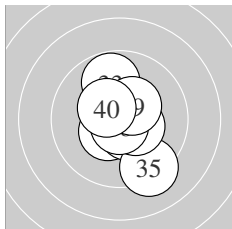

Serie 4:
 10.5 * 10.4 * 9.8 ↑ 10.5 * 9.2 ↘
 10.6 * 10.4 * 10.8 * 10.4 * 10.4 *
 beste Teiler 47.0 (38.) 88.3 (36.) 111.5 (34.)
 Trefferlage 0.23 mm rechts, 0.07 mm tief
 Streuwert 1.43, horizontal: 1.10, vertikal: 1.70

Unterschrift des Schützen

Ergebnis: **385** (403.0)
 Serien: 99 95 95 96
 Zähler: 26 13 1 0 0 0 0 0 0 0
 Innenzehner: 20
 weiteste: 583 (12), 436 (35), 429 (19)
 beste Teiler 20.2 (13.) 55.5 (11.) 57.6 (6.)
 Trefferlage 0.01 mm links, 0.54 mm tief
 Streuwert 1.75, horizontal: 1.64, vertikal: 1.85

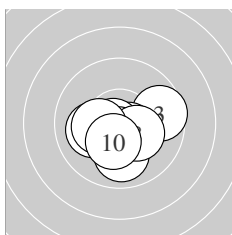
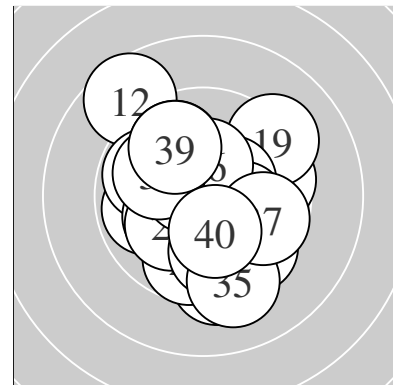

Serie 1:
 10.6 * 10.1 ← 9.6 → 10.6 * 10.0 ↓
 10.7 * 10.6 * 10.3 * 10.3 * 10.3 *
 beste Teiler 57.6 (6.) 90.4 (4.) 93.2 (7.)
 Trefferlage 0.03 mm links, 0.68 mm tief
 Streuwert 1.25, horizontal: 1.54, vertikal: 0.86

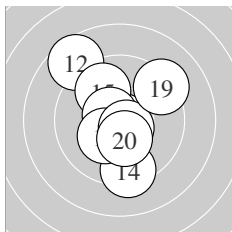

Serie 2:
 10.7 * 8.6 ↖ 10.9 * 9.3 ↓ 9.9 ↖
 10.6 * 10.3 * 10.6 * 9.2 ↗ 10.3 *
 beste Teiler 20.2 (13.) 55.5 (11.) 82.3 (18.)
 Trefferlage 0.15 mm links, 0.21 mm hoch
 Streuwert 2.15, horizontal: 1.77, vertikal: 2.46

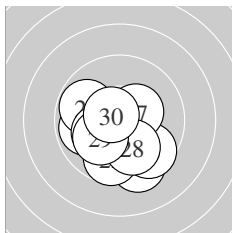

Serie 3:
 9.4 ↓ 9.7 ↓ 9.9 ← 9.8 ↖ 9.6 ↘
 10.2 * 10.4 * 10.0 ↓ 10.1 ↗ 10.6 *
 beste Teiler 79.6 (30.) 147.1 (27.) 193.2 (26.)
 Trefferlage 0.36 mm links, 1.21 mm tief
 Streuwert 1.70, horizontal: 1.80, vertikal: 1.60

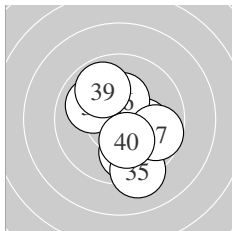

Serie 4:
 9.9 ↓ 10.2 * 10.1 ↘ 10.3 * 9.2 ↓
 10.3 * 9.7 ↘ 10.0 ↖ 9.9 ↖ 10.2 *
 beste Teiler 151.9 (36.) 166.0 (34.) 181.5 (40.)
 Trefferlage 0.48 mm rechts, 0.50 mm tief
 Streuwert 1.84, horizontal: 1.59, vertikal: 2.06

Unterschrift des Schützen

Meyton Elektronik

Ergebnis: **386** (403.0)
 Serien: 99 95 98 94
 Zähler: 27 12 1 0 0 0 0 0 0 0
 Innenzehner: 23
 weiteste: 640 (37), 488 (32), 417 (7)
 beste Teiler 55.2 (25.) 55.4 (3.) 92.1 (9.)
 Trefferlage 0.52 mm links, 0.33 mm hoch
 Streuwert 1.74, horizontal: 1.84, vertikal: 1.64

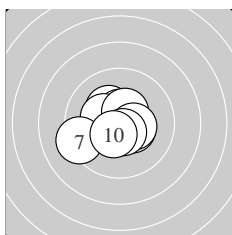
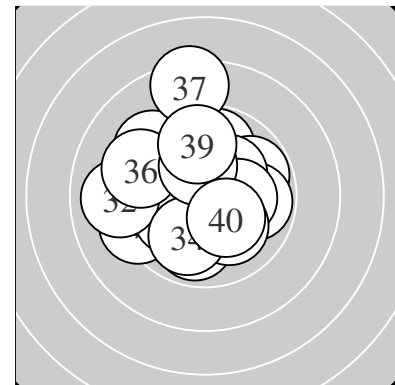

Serie 1:
 10.3 * 10.6 * 10.7 * 10.3 * 10.5 *
 10.4 * 9.3 ← 10.4 * 10.6 * 10.5 *
 beste Teiler 55.4 (3.) 92.1 (9.) 100.0 (2.)
 Trefferlage 0.32 mm links, 0.00 mm
 Streuwert 1.30, horizontal: 1.53, vertikal: 1.03

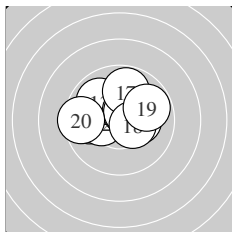

Serie 2:
 9.8 ← 10.3 * 9.9 ↘ 10.5 * 10.5 *
 10.2 * 9.8 ↑ 10.4 * 9.8 → 9.5 ←
 beste Teiler 104.2 (14.) 109.1 (15.) 132.8 (18.)
 Trefferlage 0.26 mm links, 0.66 mm hoch
 Streuwert 1.66, horizontal: 2.12, vertikal: 1.02

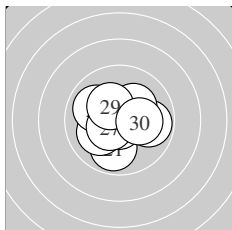

Serie 3:
 9.9 ↓ 10.3 * 10.1 ← 10.0 ↘ 10.7 *
 9.8 → 10.5 * 10.2 * 10.3 * 10.2 *
 beste Teiler 55.2 (25.) 114.2 (27.) 160.0 (29.)
 Trefferlage 0.23 mm links, 0.16 mm tief
 Streuwert 1.47, horizontal: 1.70, vertikal: 1.21

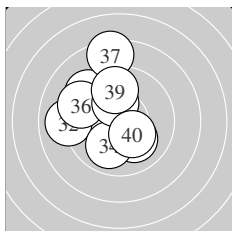

Serie 4:
 10.3 * 9.0 ← 10.1 ↘ 10.0 ↓ 9.3 ↘
 9.3 ↘ 8.4 ↑ 10.2 * 9.8 ↑ 10.3 *
 beste Teiler 169.7 (31.) 173.2 (40.) 176.8 (38.)
 Trefferlage 1.27 mm links, 0.84 mm hoch
 Streuwert 2.39, horizontal: 2.02, vertikal: 2.71

Unterschrift des Schützen

Meyton Elektronik

Ergebnis: **383** (399.7)
 Serien: 98 93 96 96
 Zähler: 26 11 3 0 0 0 0 0 0 0
 Innenzehner: 20
 weiteste: 640 (36), 519 (28), 507 (12)
 beste Teiler 13.3 (4.) 68.9 (24.) 71.0 (3.)
 Trefferlage 0.63 mm links, 0.17 mm hoch
 Streuwert 1.95, horizontal: 2.07, vertikal: 1.83

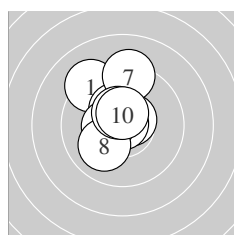
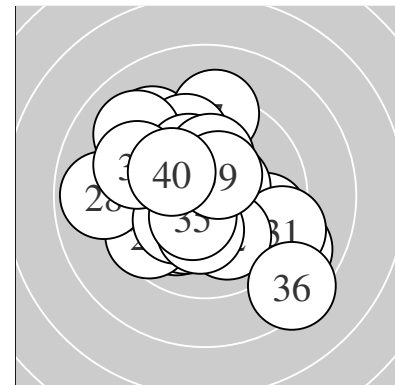

Serie 1:
 9.2 ↘ 10.6 * 10.7 * 10.9 * 10.4 *
 10.4 * 9.3 ↑ 10.0 ↙ 10.5 * 10.5 *
 beste Teiler 13.3 (4.) 71.0 (3.) 81.2 (2.)
 Trefferlage 0.61 mm links, 0.98 mm hoch
 Streuwert 1.41, horizontal: 1.02, vertikal: 1.72

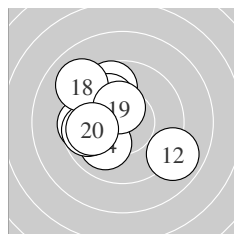

Serie 2:
 10.2 * 8.9 ↘ 9.6 ← 10.0 ↙ 9.7 ←
 9.7 ↑ 10.1 ↘ 9.1 ↘ 10.4 * 9.9 ←
 beste Teiler 128.5 (19.) 191.1 (11.) 224.1 (17.)
 Trefferlage 1.37 mm links, 0.42 mm hoch
 Streuwert 2.11, horizontal: 2.25, vertikal: 1.96

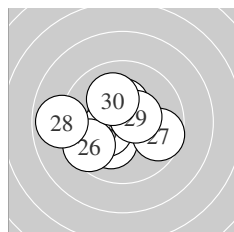

Serie 3:
 10.2 * 10.4 * 10.5 * 10.7 * 10.3 *
 9.6 ↙ 9.7 ↘ 8.9 ← 10.5 * 10.1 ↘
 beste Teiler 68.9 (24.) 106.3 (23.) 120.1 (29.)
 Trefferlage 0.84 mm links, 0.05 mm tief
 Streuwert 1.80, horizontal: 2.19, vertikal: 1.31

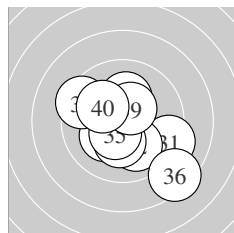

Serie 4:
 9.2 ↘ 10.0 ↘ 10.2 * 10.3 * 10.5 *
 8.4 ↘ 10.2 * 9.4 ↘ 10.4 * 10.1 ↘
 beste Teiler 121.5 (35.) 126.7 (39.) 175.7 (34.)
 Trefferlage 0.29 mm rechts, 0.65 mm tief
 Streuwert 2.27, horizontal: 2.45, vertikal: 2.08

Unterschrift des Schützen

Ergebnis: **382** (402.0)
 Serien: 95 97 94 96
 Zähler: 24 14 2 0 0 0 0 0 0 0
 Innenzehner: 18
 weiteste: 630 (24), 563 (40), 449 (9)
 beste Teiler 16.7 (14.) 18.2 (37.) 34.7 (25.)
 Trefferlage 0.52 mm rechts, 0.05 mm tief
 Streuwert 1.86, horizontal: 2.05, vertikal: 1.64

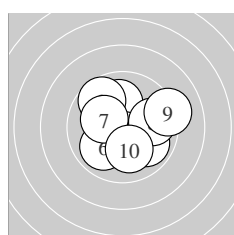
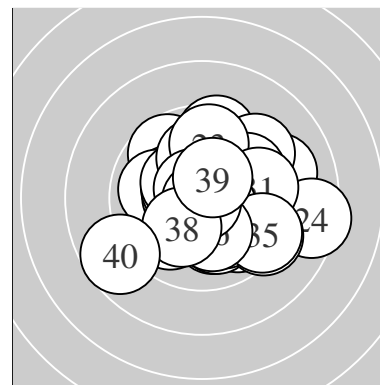

Serie 1:
 10.0 ↑ 9.9 ↘ 9.7 ↘ 10.5 * 10.6 *
 9.9 ↙ 10.2 * 9.8 → 9.2 → 10.1 ↓
 beste Teiler 86.0 (5.) 112.4 (4.) 188.5 (7.)
 Trefferlage 0.33 mm rechts, 0.08 mm hoch
 Streuwert 1.92, horizontal: 2.15, vertikal: 1.65

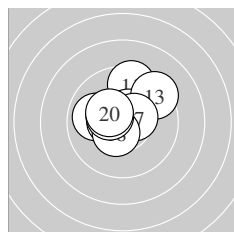

Serie 2:
 9.5 ↑ 10.5 * 9.4 ↗ 10.9 * 9.9 ←
 10.5 * 10.5 * 10.5 * 10.4 * 10.3 *
 beste Teiler 16.7 (14.) 101.3 (12.) 114.1 (16.)
 Trefferlage 0.14 mm links, 0.84 mm hoch
 Streuwert 1.43, horizontal: 1.56, vertikal: 1.30

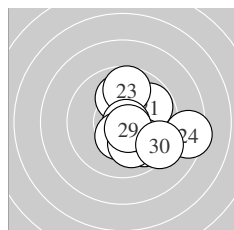

Serie 3:
 9.8 ↗ 10.0 ↑ 9.7 ↑ 8.4 → 10.8 *
 9.8 ↘ 10.4 * 10.1 ↓ 10.6 * 9.3 ↘
 beste Teiler 34.7 (25.) 80.8 (29.) 136.1 (27.)
 Trefferlage 1.55 mm rechts, 0.25 mm tief
 Streuwert 1.97, horizontal: 2.06, vertikal: 1.88

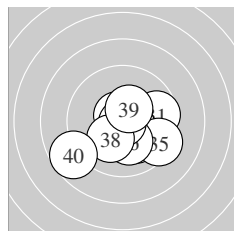

Serie 4:
 9.7 → 10.7 * 10.6 * 10.1 ↓ 9.4 ↘
 10.2 * 10.9 * 10.1 ↙ 10.4 * 8.7 ↙
 beste Teiler 18.2 (37.) 72.1 (32.) 93.6 (33.)
 Trefferlage 0.35 mm rechts, 0.88 mm tief
 Streuwert 1.89, horizontal: 2.27, vertikal: 1.41

Unterschrift des Schützen

Meyton Elektronik

Ergebnis: **368** (388.5)
 Serien: 90 92 91 95
 Zähler: 14 22 2 2 0 0 0 0 0 0
 Innenzehner: 14
 weiteste: 873 (14), 865 (6), 723 (21)
 beste Teiler 89.6 (34.) 92.6 (18.) 108.9 (11.)
 Trefferlage 0.06 mm links, 0.00 mm
 Streuwert 2.60, horizontal: 3.13, vertikal: 1.94

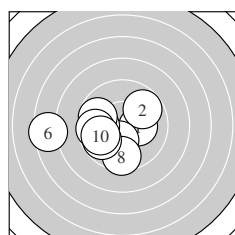
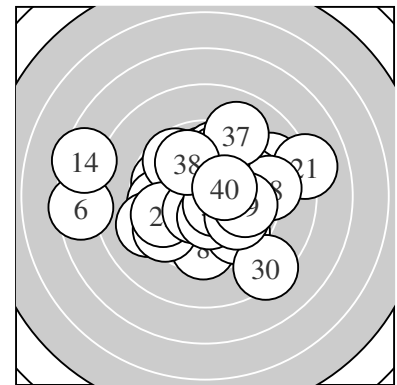

Serie 1:
 10.2 * 9.8 ↗ 10.2 * 9.9 ← 9.7 ↖
 7.5 ← 9.7 ← 9.5 ↓ 9.8 ↙ 9.8 ←
 beste Teiler 179.6 (1.) 179.8 (3.) 260.3 (4.)
 Trefferlage 1.86 mm links, 0.69 mm tief
 Streuwert 2.43, horizontal: 3.08, vertikal: 1.50

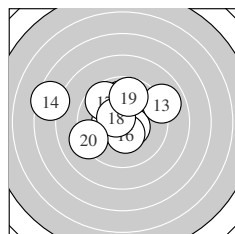

Serie 2:
 10.5 * 9.9 ↑ 9.0 ↗ 7.5 ↖ 10.4 *
 10.4 * 9.7 ↘ 10.6 * 9.7 ↑ 9.2 ←
 beste Teiler 92.6 (18.) 108.9 (11.) 132.5 (15.)
 Trefferlage 1.01 mm links, 0.92 mm hoch
 Streuwert 2.72, horizontal: 3.40, vertikal: 1.81

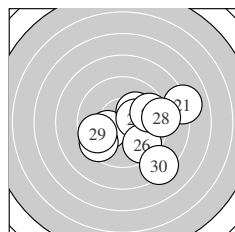

Serie 3:
 8.1 → 10.2 * 9.5 ↙ 10.2 * 10.3 *
 9.6 ↘ 9.6 → 9.2 → 9.7 ← 8.4 ↘
 beste Teiler 153.8 (25.) 193.0 (24.) 195.4 (22.)
 Trefferlage 1.64 mm rechts, 0.66 mm tief
 Streuwert 2.77, horizontal: 3.28, vertikal: 2.15

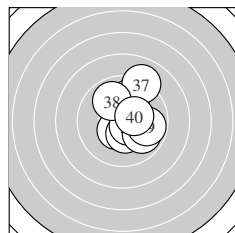

Serie 4:
 10.4 * 10.4 * 10.4 * 10.6 * 9.9 ↘
 9.9 ↑ 9.0 ↑ 9.9 ↘ 9.8 → 10.4 *
 beste Teiler 89.6 (34.) 126.7 (31.) 146.5 (40.)
 Trefferlage 0.98 mm rechts, 0.40 mm hoch
 Streuwert 1.67, horizontal: 1.28, vertikal: 1.99

Unterschrift des Schützen

Ergebnis:	383	(401.2)
Serien:	97 93 98 95	
Zähler:	25 13 2 0 0 0 0 0 0 0	
Innenzehner:	20	
weiteste:	701 (36), 614 (19), 465 (14)	
beste Teiler	13.0 (3.) 34.9 (17.) 68.0 (33.)	
Trefferlage	0.23 mm links, 0.57 mm hoch	
Streuwert	1.90, horizontal: 2.28, vertikal: 1.42	

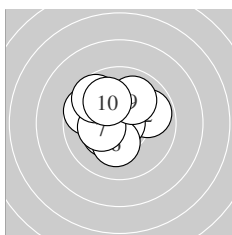
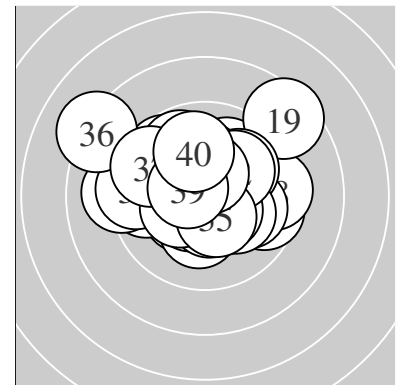

Serie 1:	10.6 *	9.9 →	10.9 *	10.3 *	9.7 ↖
	10.2 *	10.3 *	9.7 ↘	10.0 ↗	10.0 ↘
beste Teiler	13.0 (3.)	77.9 (1.)	154.6 (4.)		
Trefferlage	0.50 mm links, 0.59 mm hoch				
Streuwert	1.53, horizontal: 1.68, vertikal: 1.37				

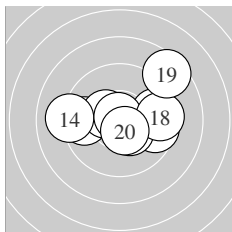

Serie 2:	9.6 ←	9.6 →	10.4 *	9.1 ←	9.6 →
	10.4 *	10.8 *	9.4 →	8.5 ↗	10.5 *
beste Teiler	34.9 (17.)	109.1 (20.)	141.0 (13.)		
Trefferlage	0.68 mm rechts, 0.35 mm hoch				
Streuwert	2.44, horizontal: 3.09, vertikal: 1.53				

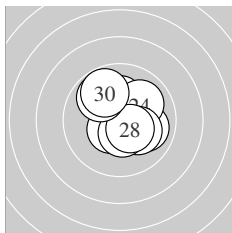

Serie 3:	10.6 *	10.2 *	10.0 →	10.0 ↗	10.2 *
	10.5 *	10.5 *	10.5 *	9.9 ↘	9.8 ↘
beste Teiler	99.0 (21.)	116.0 (26.)	121.5 (27.)		
Trefferlage	0.30 mm rechts, 0.44 mm hoch				
Streuwert	1.44, horizontal: 1.40, vertikal: 1.48				

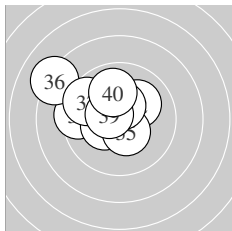

Serie 4:	9.4 ←	10.1 ↗	10.7 *	10.3 *	10.4 *
	8.1 ↘	9.6 ↘	10.5 *	10.5 *	9.9 ↗
beste Teiler	68.0 (33.)	105.6 (39.)	125.4 (38.)		
Trefferlage	1.40 mm links, 0.90 mm hoch				
Streuwert	1.92, horizontal: 2.30, vertikal: 1.45				

Unterschrift des Schützen

Ergebnis: **396** (409.6)

Serien: 97 100 99 100

Zähler: 36 4 0 0 0 0 0 0 0 0

Innenzehner: 23

weiteste: 373 (2), 314 (30), 269 (9)

beste Teiler 29.0 (39.) 43.0 (37.) 53.7 (27.)

Trefferlage 0.00 mm , 0.36 mm hoch

Streuwert 1.35, horizontal: 1.42, vertikal: 1.28

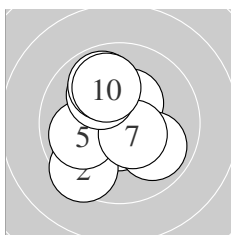
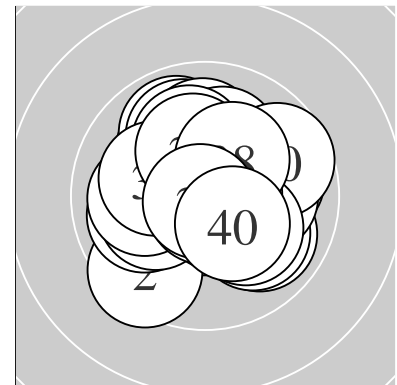

Serie 1:

10.6 *	9.5 ↙	10.4 *	10.3 *	10.0 ←
9.9 ↘	10.5 *	10.1 ↘	9.9 ↗	10.0 ↑

beste Teiler 86.1 (1.) 112.1 (7.) 144.9 (3.)

Trefferlage 0.59 mm links, 0.11 mm hoch

Streuwert 1.64, horizontal: 1.47, vertikal: 1.79

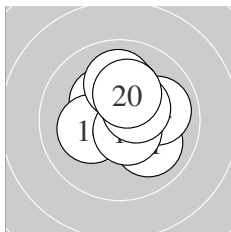

Serie 2:

10.0 ↘	10.2 *	10.5 *	10.0 →	10.3 *
10.2 *	10.6 *	10.4 *	10.0 ↑	10.2 *

beste Teiler 85.8 (17.) 112.2 (13.) 132.0 (18.)

Trefferlage 0.48 mm rechts, 0.61 mm hoch

Streuwert 1.25, horizontal: 1.27, vertikal: 1.23

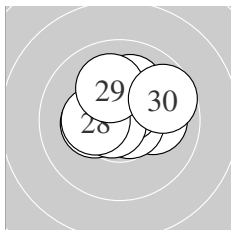

Serie 3:

10.1 →	10.7 *	10.2 *	10.6 *	10.3 *
10.1 ↑	10.7 *	10.3 *	10.1 ↑	9.7 →

beste Teiler 53.7 (27.) 70.0 (22.) 93.0 (24.)

Trefferlage 0.34 mm rechts, 0.71 mm hoch

Streuwert 1.24, horizontal: 1.46, vertikal: 0.97

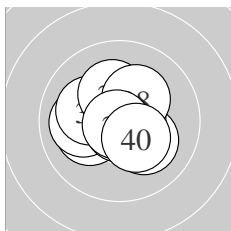

Serie 4:

10.1 ←	10.0 ←	10.1 ↘	10.1 ↖	10.2 *
10.6 *	10.8 *	10.2 *	10.8 *	10.3 *

beste Teiler 29.0 (39.) 43.0 (37.) 77.3 (36.)

Trefferlage 0.24 mm links, 0.02 mm hoch

Streuwert 1.23, horizontal: 1.42, vertikal: 1.00

Unterschrift des Schützen

Ergebnis:	381	(399.9)							
Serien:	94	96	95	96					
Zähler:	22	17	1	0	0	0	0	0	0
Innenzehner:	16								
weiteste:	532 (25), 467 (20), 466 (6)								
beste Teiler	41.0 (5.)	61.0 (4.)	62.5 (36.)						
Trefferlage	0.39 mm links, 0.29 mm hoch								
Streuwert	1.86, horizontal: 2.02, vertikal: 1.69								

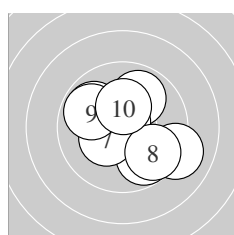
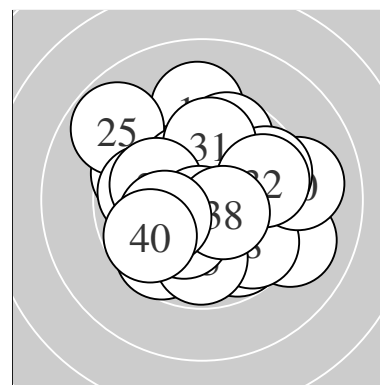

Serie 1:	9.8 ↘	9.9 ↖	9.9 ↗	10.7 *	10.8 *
	9.1 ↘	10.3 *	9.7 ↘	9.8 ↖	10.3 *
beste Teiler	41.0 (5.) 61.0 (4.) 155.3 (7.)				
Trefferlage	0.30 mm rechts, 0.01 mm tief				
Streuwert	1.93, horizontal: 2.13, vertikal: 1.71				

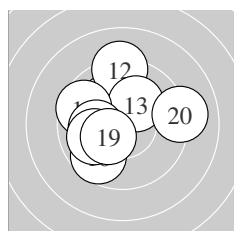

Serie 2:	10.1 ↘	9.2 ↑	10.2 *	9.6 ↖	10.3 *
	9.7 ↙	10.1 ←	10.0 ←	10.3 *	9.1 →
beste Teiler	152.3 (19.) 166.0 (15.) 194.9 (13.)				
Trefferlage	0.77 mm links, 0.38 mm hoch				
Streuwert	2.10, horizontal: 2.22, vertikal: 1.98				

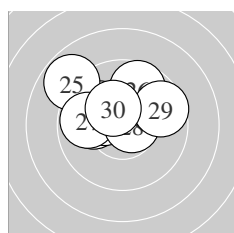

Serie 3:	10.1 ↘	10.0 ←	10.3 *	10.4 *	8.8 ↖
	9.7 ↗	9.8 ←	10.7 *	9.6 →	10.3 *
beste Teiler	73.0 (28.) 134.3 (24.) 154.9 (30.)				
Trefferlage	0.75 mm links, 1.28 mm hoch				
Streuwert	1.72, horizontal: 2.16, vertikal: 1.11				

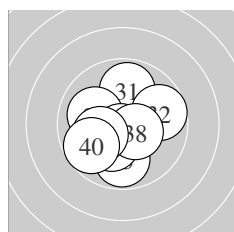

Serie 4:	9.9 ↑	9.7 →	10.6 *	10.0 ↖	9.8 ↓
	10.7 *	10.2 *	10.5 *	10.2 *	9.7 ↙
beste Teiler	62.5 (36.) 100.3 (33.) 118.8 (38.)				
Trefferlage	0.36 mm links, 0.47 mm tief				
Streuwert	1.59, horizontal: 1.62, vertikal: 1.56				

Unterschrift des Schützen

Meyton Elektronik

Ergebnis:	390	(408.5)
Serien:	96 99 98 97	
Zähler:	30 10 0 0 0 0 0 0 0 0	
Innenzehner:	24	
weiteste:	357 (5), 339 (29), 315 (31)	
beste Teiler	53.9 (15.) 54.0 (21.) 57.8 (36.)	
Trefferlage	0.15 mm rechts, 0.38 mm hoch	
Streuwert	1.43, horizontal: 1.74, vertikal: 1.03	

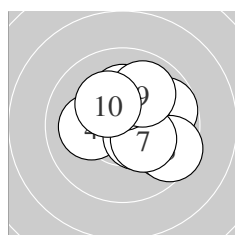
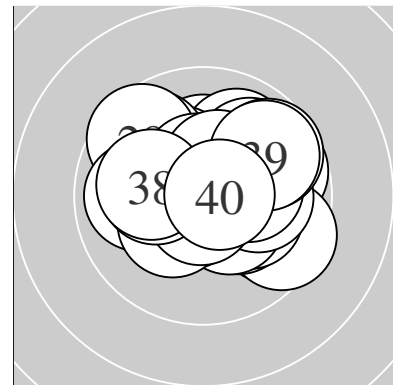

Serie 1:	9.7 ↘	10.4 *	9.7 →	10.1 ←	9.5 ↘
	10.5 *	10.3 *	10.2 *	9.9 ↗	10.3 *
beste Teiler	119.9 (6.)	132.4 (2.)	170.2 (7.)		
Trefferlage	0.84 mm rechts, 0.25 mm hoch				
Streuwert	1.62, horizontal: 1.83, vertikal: 1.37				

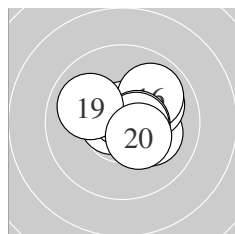

Serie 2:	10.4 *	10.7 *	10.2 *	10.0 ↗	10.7 *
	9.9 ↗	10.6 *	10.6 *	10.0 ↘	10.4 *
beste Teiler	53.9 (15.)	68.1 (12.)	94.5 (18.)		
Trefferlage	0.69 mm rechts, 0.19 mm hoch				
Streuwert	1.13, horizontal: 1.31, vertikal: 0.91				

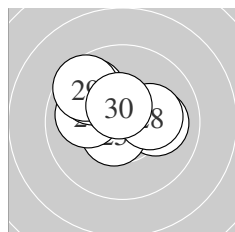

Serie 3:	10.7 *	10.4 *	10.1 →	10.5 *	10.6 *
	10.0 ←	9.8 ↘	10.2 *	9.6 ↘	10.5 *
beste Teiler	54.0 (21.)	93.2 (25.)	113.7 (30.)		
Trefferlage	0.59 mm links, 0.74 mm hoch				
Streuwert	1.32, horizontal: 1.63, vertikal: 0.91				

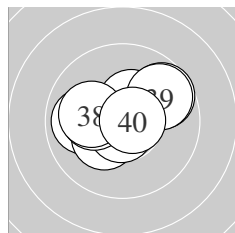

Serie 4:	9.7 ↗	10.2 *	10.4 *	9.9 ←	10.3 *
	10.7 *	10.2 *	10.1 ←	9.8 ↗	10.7 *
beste Teiler	57.8 (36.)	67.1 (40.)	138.2 (33.)		
Trefferlage	0.34 mm links, 0.34 mm hoch				
Streuwert	1.51, horizontal: 1.91, vertikal: 0.94				

Unterschrift des Schützen

Ergebnis: **377** (396.0)
 Serien: 96 92 94 95
 Zähler: 19 19 2 0 0 0 0 0 0 0
 Innenzehner: 16
 weiteste: 611 (15), 552 (20), 458 (39)
 beste Teiler 67.0 (38.) 83.1 (6.) 90.8 (35.)
 Trefferlage 0.03 mm rechts, 0.82 mm hoch
 Streuwert 1.99, horizontal: 2.41, vertikal: 1.47

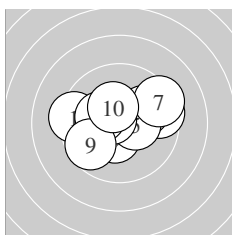
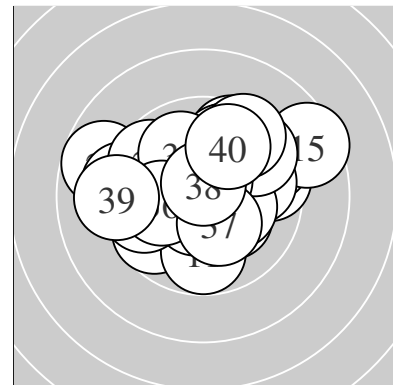

Serie 1:
 9.3 ← 9.5 → 10.4 * 10.0 → 10.4 *
 10.6 * 9.4 ↗ 10.2 * 9.7 ↖ 10.3 *
 beste Teiler 83.1 (6.) 133.4 (3.) 139.5 (5.)
 Trefferlage 0.04 mm rechts, 0.35 mm hoch
 Streuwert 1.97, horizontal: 2.52, vertikal: 1.17

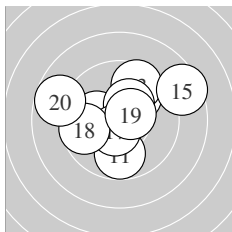

Serie 2:
 9.8 ↓ 9.9 ↗ 9.6 ↗ 10.1 ← 8.5 →
 10.3 * 10.6 * 9.7 ← 10.5 * 8.7 ←
 beste Teiler 99.0 (17.) 111.0 (19.) 162.2 (16.)
 Trefferlage 0.05 mm links, 0.71 mm hoch
 Streuwert 2.46, horizontal: 2.94, vertikal: 1.86

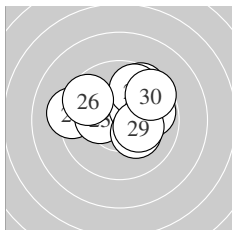

Serie 3:
 9.3 ← 9.6 ↗ 10.3 * 10.3 * 9.8 ↗
 9.6 ↖ 9.8 → 10.2 * 10.2 * 9.5 ↗
 beste Teiler 167.1 (24.) 172.9 (23.) 176.4 (29.)
 Trefferlage 0.43 mm rechts, 1.04 mm hoch
 Streuwert 1.96, horizontal: 2.43, vertikal: 1.34

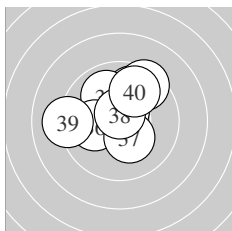

Serie 4:
 10.2 * 9.8 ↗ 9.9 ↖ 9.4 ↗ 10.6 *
 10.1 ← 10.3 * 10.7 * 9.1 ← 9.8 ↗
 beste Teiler 67.0 (38.) 90.8 (35.) 168.5 (37.)
 Trefferlage 0.28 mm links, 1.20 mm hoch
 Streuwert 1.76, horizontal: 1.97, vertikal: 1.52

Unterschrift des Schützen

Meyton Elektronik

Ergebnis: **371** (388.2)
 Serien: 93 88 96 94
 Zähler: 17 18 4 1 0 0 0 0 0 0
 Innenzehner: 11
 weiteste: 767 (15), 737 (2), 569 (17)
 beste Teiler 34.2 (37.) 40.6 (39.) 79.3 (25.)
 Trefferlage 0.18 mm rechts, 1.27 mm hoch
 Streuwert 2.39, horizontal: 2.53, vertikal: 2.25

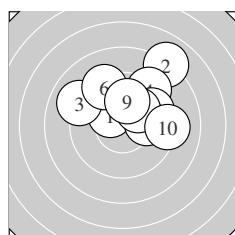
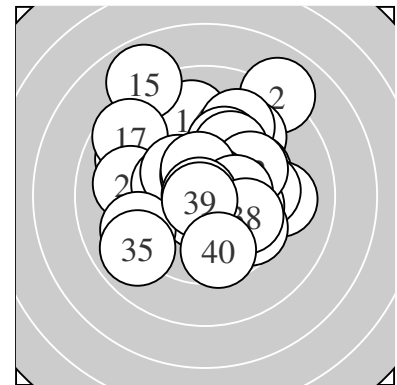

Serie 1:
 10.3 * 8.0 ↗ 9.0 ↘ 9.2 ↗ 9.7 ↗
 9.3 ↘ 10.0 → 10.1 ↗ 10.0 ↑ 9.2 →
 beste Teiler 158.2 (1.) 213.5 (8.) 240.9 (7.)
 Trefferlage 1.13 mm rechts, 2.18 mm hoch
 Streuwert 2.39, horizontal: 2.83, vertikal: 1.85

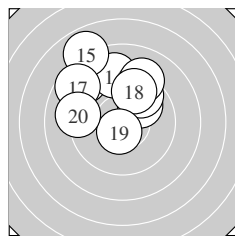

Serie 2:
 10.0 ↗ 9.7 ↗ 8.7 ↘ 9.1 ↑ 7.9 ↘
 9.1 ↗ 8.7 ↘ 9.6 ↑ 10.6 * 9.2 ←
 beste Teiler 99.9 (19.) 240.4 (11.) 322.3 (12.)
 Trefferlage 1.08 mm links, 3.03 mm hoch
 Streuwert 2.47, horizontal: 2.74, vertikal: 2.17

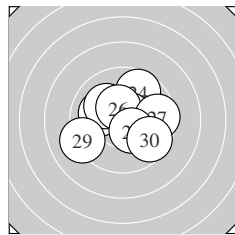

Serie 3:
 10.4 * 10.1 ↘ 10.1 ↘ 9.7 ↗ 10.6 *
 10.4 * 9.6 → 10.4 * 9.2 ↙ 9.6 ↘
 beste Teiler 79.3 (25.) 128.5 (21.) 131.8 (26.)
 Trefferlage 0.13 mm rechts, 0.32 mm hoch
 Streuwert 1.93, horizontal: 2.26, vertikal: 1.54

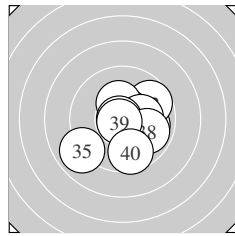

Serie 4:
 9.9 → 9.7 ↗ 10.6 * 10.3 * 8.9 ↙
 10.2 * 10.8 * 9.9 ↘ 10.8 * 9.6 ↓
 beste Teiler 34.2 (37.) 40.6 (39.) 84.2 (33.)
 Trefferlage 0.56 mm rechts, 0.43 mm tief
 Streuwert 1.86, horizontal: 2.02, vertikal: 1.68

Unterschrift des Schützen

Meyton Elektronik

Ergebnis:	381	(396.7)
Serien:	96	95 95 95
Zähler:	25	11 4 0 0 0 0 0 0 0
Innenzehner:	18	
weiteste:	591	(22), 573 (11), 538 (13)
beste Teiler	17.8	(24.) 50.8 (40.) 53.2 (15.)
Trefferlage	0.61 mm	links, 0.46 mm hoch
Streuwert	2.12,	horizontal: 2.35, vertikal: 1.85

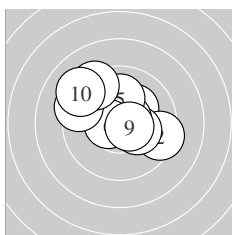
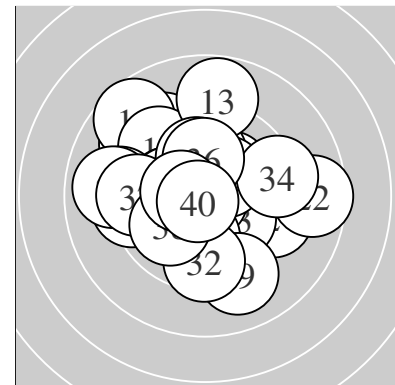

Serie 1:	10.2 *	9.4 →	10.3 *	10.6 *	10.0 ↑
	10.5 *	9.3 ↖	9.3 ↘	10.6 *	9.1 ↖
beste Teiler	80.1	(4.) 95.1 (9.)	102.3 (6.)		
Trefferlage	0.23 mm	links, 0.96 mm hoch			
Streuwert	2.03,	horizontal: 2.41, vertikal: 1.56			

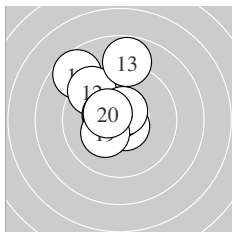

Serie 2:	8.7 ↘	9.5 ↘	8.8 ↑	10.7 *	10.7 *
	10.4 *	10.5 *	10.6 *	10.2 *	10.5 *
beste Teiler	53.2	(15.) 75.0 (14.)	88.9 (18.)		
Trefferlage	0.99 mm	links, 1.34 mm hoch			
Streuwert	1.78,	horizontal: 1.43, vertikal: 2.08			

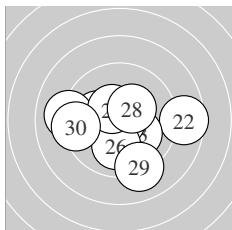

Serie 3:	10.1 ↖	8.6 →	10.1 ↘	10.9 *	9.1 ←
	10.0 ↓	10.5 *	10.3 *	9.1 ↓	9.3 ←
beste Teiler	17.8	(24.) 123.7 (27.)	154.2 (28.)		
Trefferlage	0.11 mm	links, 0.55 mm tief			
Streuwert	2.47,	horizontal: 3.07, vertikal: 1.67			

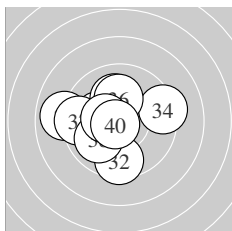

Serie 4:	8.9 ←	9.5 ↓	10.2 *	9.3 →	10.1 ↑
	10.1 ↑	9.5 ←	10.0 ↙	10.4 *	10.8 *
beste Teiler	50.8	(40.) 134.3 (39.)	196.9 (33.)		
Trefferlage	1.10 mm	links, 0.09 mm hoch			
Streuwert	2.09,	horizontal: 2.42, vertikal: 1.69			

Unterschrift des Schützen

Meyton Elektronik

Ergebnis: **365** (384.1)
 Serien: 89 92 92 92
 Zähler: 13 19 8 0 0 0 0 0 0 0
 Innenzehner: 10
 weiteste: 690 (10), 633 (2), 614 (18)
 beste Teiler 44.5 (33.) 82.6 (34.) 83.0 (26.)
 Trefferlage 0.33 mm links, 0.14 mm hoch
 Streuwert 2.69, horizontal: 3.12, vertikal: 2.18

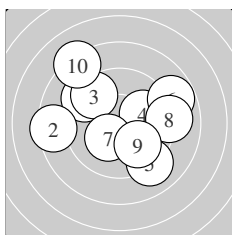
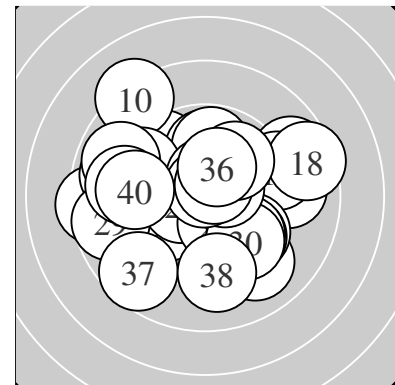

Serie 1:
 9.3 ↘ 8.4 ← 9.5 ↘ 10.0 → 9.1 ↘
 8.8 → 10.3 * 9.1 → 9.9 ↘ 8.2 ↘
 beste Teiler 175.8 (7.) 239.9 (4.) 264.5 (9.)
 Trefferlage 0.07 mm links, 0.66 mm hoch
 Streuwert 3.36, horizontal: 3.90, vertikal: 2.71

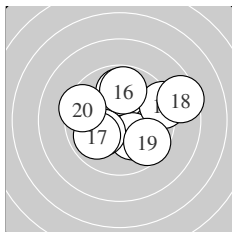

Serie 2:
 10.0 ↑ 9.9 ↑ 10.2 * 10.1 ↙ 9.2 →
 9.8 ↑ 9.9 ↙ 8.5 → 9.6 ↘ 9.5 ←
 beste Teiler 195.8 (13.) 205.2 (14.) 233.8 (11.)
 Trefferlage 0.68 mm rechts, 0.61 mm hoch
 Streuwert 2.46, horizontal: 2.88, vertikal: 1.96

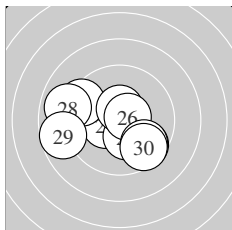

Serie 3:
 10.4 * 9.6 ↘ 10.3 * 9.4 ↖ 10.5 *
 10.6 * 9.7 ↘ 8.9 ← 8.7 ← 9.6 ↘
 beste Teiler 83.0 (26.) 109.0 (25.) 141.3 (21.)
 Trefferlage 0.68 mm links, 0.62 mm tief
 Streuwert 2.41, horizontal: 3.01, vertikal: 1.61

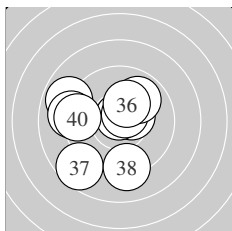

Serie 4:
 8.9 ↖ 10.5 * 10.8 * 10.6 * 9.9 ↗
 10.2 * 8.6 ↗ 9.2 ↓ 9.1 ← 9.3 ←
 beste Teiler 44.5 (33.) 82.6 (34.) 122.5 (32.)
 Trefferlage 1.26 mm links, 0.05 mm tief
 Streuwert 2.52, horizontal: 2.68, vertikal: 2.36

Unterschrift des Schützen

Meyton Elektronik

Ergebnis: **387** (404.3)
 Serien: 97 95 97 98
 Zähler: 27 13 0 0 0 0 0 0 0 0
 Innenzehner: 22
 weiteste: 489 (16), 403 (25), 380 (10)
 beste Teiler 57.4 (30.) 60.3 (12.) 67.6 (29.)
 Trefferlage 0.96 mm rechts, 0.25 mm tief
 Streuwert 1.51, horizontal: 1.70, vertikal: 1.30

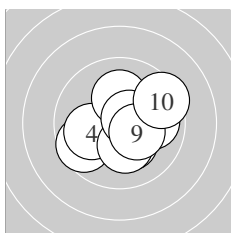
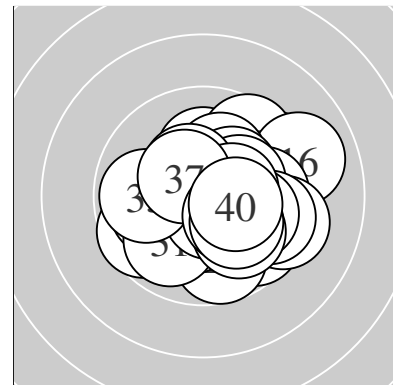

Serie 1:
 10.3 * 10.6 * 9.6 ↙ 10.0 ↙ 10.2 *
 10.1 ↑ 9.9 → 10.6 * 10.3 * 9.4 ↗
 beste Teiler 85.4 (8.) 89.4 (2.) 155.1 (9.)
 Trefferlage 0.50 mm rechts, 0.23 mm tief
 Streuwert 1.64, horizontal: 1.89, vertikal: 1.35

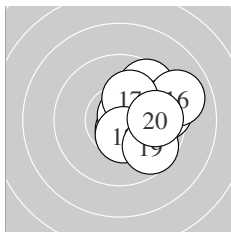

Serie 2:
 10.6 * 10.7 * 10.2 * 9.5 → 9.6 ↗
 9.0 ↗ 10.2 * 10.5 * 9.7 ↘ 9.8 →
 beste Teiler 60.3 (12.) 80.7 (11.) 120.7 (18.)
 Trefferlage 1.88 mm rechts, 0.45 mm hoch
 Streuwert 1.47, horizontal: 1.48, vertikal: 1.47

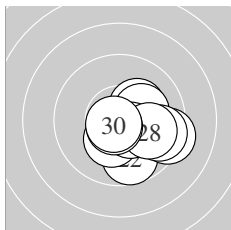

Serie 3:
 10.2 * 9.7 ↓ 10.2 * 10.3 * 9.3 →
 10.5 * 9.6 ↘ 10.0 ↘ 10.7 * 10.7 *
 beste Teiler 57.4 (30.) 67.6 (29.) 119.6 (26.)
 Trefferlage 1.26 mm rechts, 0.75 mm tief
 Streuwert 1.35, horizontal: 1.54, vertikal: 1.12

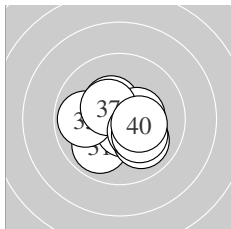

Serie 4:
 9.9 ↙ 10.4 * 10.6 * 10.0 ↘ 9.9 ←
 10.4 * 10.4 * 10.3 * 10.1 ↘ 10.3 *
 beste Teiler 85.6 (33.) 128.7 (37.) 138.3 (32.)
 Trefferlage 0.19 mm rechts, 0.47 mm tief
 Streuwert 1.35, horizontal: 1.57, vertikal: 1.09

Unterschrift des Schützen

Meyton Elektronik

Ergebnis: **398** (416.3)
 Serien: 99 100 99 100
 Zähler: 38 2 0 0 0 0 0 0 0 0
 Innenzehner: 33
 weiteste: 461 (23), 279 (7), 240 (13)
 beste Teiler 39.4 (8.) 40.3 (25.) 40.8 (32.)
 Trefferlage 0.11 mm links, 0.17 mm hoch
 Streuwert 1.14, horizontal: 1.39, vertikal: 0.81

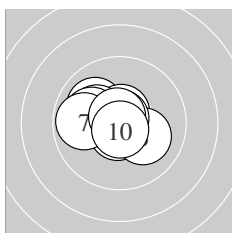
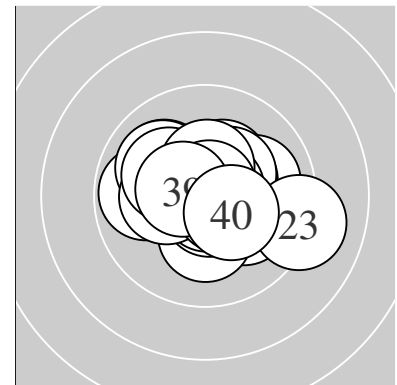

Serie 1:
 10.0 ↘ 10.6 * 10.7 * 10.2 * 10.0 ↖
 10.1 ↗ 9.8 ← 10.8 * 10.7 * 10.8 *
 beste Teiler 39.4 (8.) 50.1 (10.) 56.6 (9.)
 Trefferlage 0.70 mm links, 0.23 mm hoch
 Streuwert 1.13, horizontal: 1.42, vertikal: 0.75

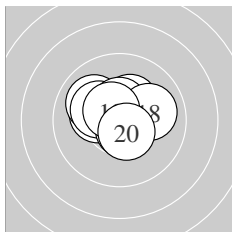

Serie 2:
 10.2 * 10.3 * 10.0 ↘ 10.2 * 10.6 *
 10.5 * 10.6 * 10.0 → 10.6 * 10.5 *
 beste Teiler 78.2 (17.) 85.0 (15.) 100.0 (19.)
 Trefferlage 0.13 mm links, 0.53 mm hoch
 Streuwert 1.11, horizontal: 1.36, vertikal: 0.78

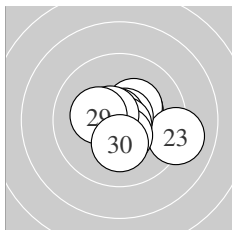

Serie 3:
 10.4 * 10.3 * 9.1 → 10.8 * 10.8 *
 10.8 * 10.5 * 10.6 * 10.3 * 10.2 *
 beste Teiler 40.3 (25.) 48.2 (24.) 49.4 (26.)
 Trefferlage 0.51 mm rechts, 0.15 mm tief
 Streuwert 1.33, horizontal: 1.62, vertikal: 0.96

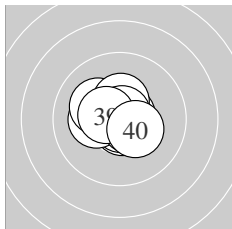

Serie 4:
 10.7 * 10.8 * 10.2 * 10.7 * 10.6 *
 10.2 * 10.4 * 10.8 * 10.5 * 10.4 *
 beste Teiler 40.8 (32.) 42.4 (38.) 64.0 (34.)
 Trefferlage 0.13 mm links, 0.10 mm hoch
 Streuwert 0.89, horizontal: 1.04, vertikal: 0.70

Unterschrift des Schützen

Ergebnis: **382** (402.0)
 Serien: 96 97 94 95
 Zähler: 23 16 1 0 0 0 0 0 0 0
 Innenzehner: 19
 weiteste: 532 (39), 432 (8), 400 (2)
 beste Teiler 28.0 (38.) 31.3 (9.) 37.2 (21.)
 Trefferlage 0.19 mm links, 0.18 mm hoch
 Streuwert 1.85, horizontal: 1.87, vertikal: 1.84

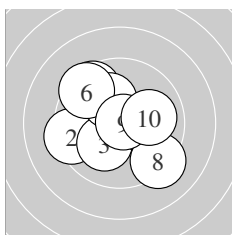
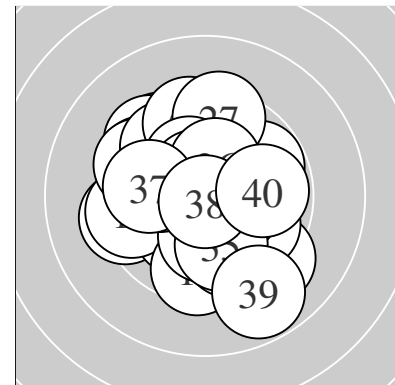

Serie 1:
 10.8 * 9.4 ← 10.1 ↙ 9.6 ↘ 10.2 *
 9.5 ↘ 10.2 * 9.2 ↘ 10.8 * 10.0 →
 beste Teiler 31.3 (9.) 48.8 (1.) 196.3 (7.)
 Trefferlage 0.26 mm links, 0.23 mm hoch
 Streuwert 2.08, horizontal: 2.29, vertikal: 1.84

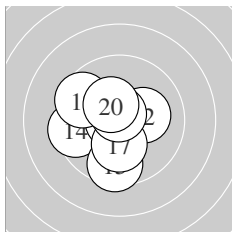

Serie 2:
 10.4 * 10.2 * 10.2 * 9.5 ← 9.5 ↓
 10.7 * 10.2 * 10.8 * 9.6 ↘ 10.4 *
 beste Teiler 49.6 (18.) 54.5 (16.) 135.3 (11.)
 Trefferlage 0.93 mm links, 0.13 mm tief
 Streuwert 1.56, horizontal: 1.55, vertikal: 1.56

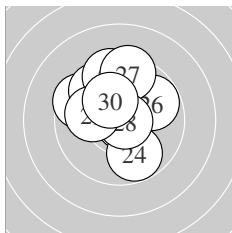

Serie 3:
 10.8 * 9.6 ↘ 9.7 ↘ 9.8 ↓ 9.5 ↑
 9.8 → 9.4 ↑ 10.8 * 10.1 ← 10.2 *
 beste Teiler 37.2 (21.) 43.9 (28.) 177.1 (30.)
 Trefferlage 0.35 mm links, 1.17 mm hoch
 Streuwert 1.82, horizontal: 1.73, vertikal: 1.91

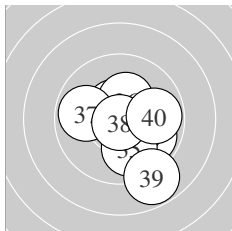

Serie 4:
 10.5 * 10.6 * 9.9 ↘ 10.4 * 10.0 ↓
 10.3 * 9.9 ← 10.8 * 8.8 ↓ 9.8 →
 beste Teiler 28.0 (38.) 97.8 (32.) 105.6 (31.)
 Trefferlage 0.78 mm rechts, 0.53 mm tief
 Streuwert 1.75, horizontal: 1.65, vertikal: 1.85

Unterschrift des Schützen

Meyton Elektronik

Ergebnis: **376** (396.4)
 Serien: 97 95 93 91
 Zähler: 18 20 2 0 0 0 0 0 0 0
 Innenzehner: 8
 weiteste: 621 (22), 510 (36), 385 (11)
 beste Teiler 41.0 (7.) 72.0 (15.) 72.0 (33.)
 Trefferlage 0.71 mm links, 0.55 mm hoch
 Streuwert 1.91, horizontal: 2.09, vertikal: 1.72

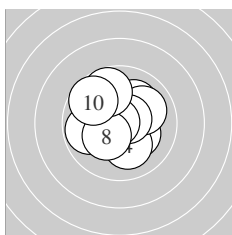
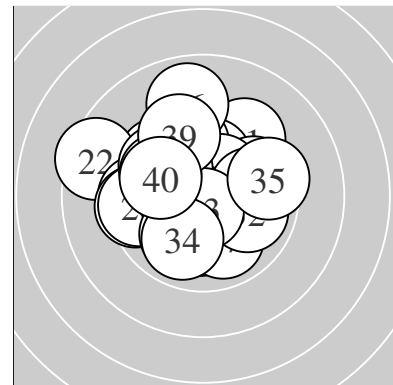

Serie 1:
 9.8 ← 10.2 * 10.1 ↗ 10.1 ↓ 10.0 ↗
 10.6 * 10.8 * 10.3 * 9.7 ↑ 9.7 ↘
 beste Teiler 41.0 (7.) 79.1 (6.) 163.3 (8.)
 Trefferlage 0.14 mm links, 0.36 mm hoch
 Streuwert 1.61, horizontal: 1.67, vertikal: 1.56

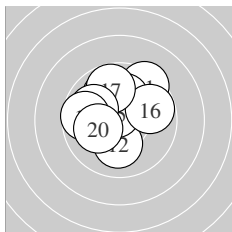

Serie 2:
 9.4 ↗ 10.1 ↓ 10.1 ↑ 10.0 ↖ 10.7 *
 9.8 → 9.8 ↑ 9.9 ↖ 9.7 ← 10.1 ←
 beste Teiler 72.0 (15.) 207.5 (13.) 210.2 (20.)
 Trefferlage 0.44 mm links, 1.03 mm hoch
 Streuwert 1.77, horizontal: 1.90, vertikal: 1.63

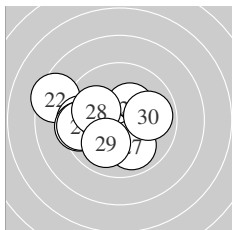

Serie 3:
 10.4 * 8.5 ↖ 9.5 ← 9.5 ← 10.2 *
 9.5 ← 9.9 ↓ 10.0 ↖ 10.0 ↙ 9.9 →
 beste Teiler 147.8 (21.) 180.8 (25.) 231.7 (28.)
 Trefferlage 1.65 mm links, 0.23 mm tief
 Streuwert 2.11, horizontal: 2.62, vertikal: 1.41

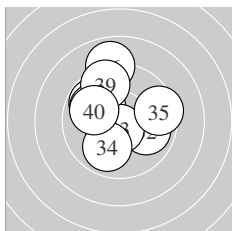

Serie 4:
 10.1 ↘ 9.9 → 10.7 * 9.9 ↙ 9.5 →
 8.9 ↑ 9.8 ↖ 9.9 ↖ 9.5 ↑ 9.9 ↖
 beste Teiler 72.0 (33.) 224.3 (31.) 253.1 (40.)
 Trefferlage 0.60 mm links, 1.07 mm hoch
 Streuwert 2.09, horizontal: 2.07, vertikal: 2.10

Unterschrift des Schützen

Meyton Elektronik

Ergebnis: **371** (389.6)
 Serien: 90 92 94 95
 Zähler: 15 21 4 0 0 0 0 0 0 0
 Innenzehner: 8
 weiteste: 589 (6), 559 (23), 512 (2)
 beste Teiler 49.2 (31.) 97.4 (7.) 98.0 (29.)
 Trefferlage 0.24 mm links, 0.88 mm hoch
 Streuwert 2.28, horizontal: 2.71, vertikal: 1.74

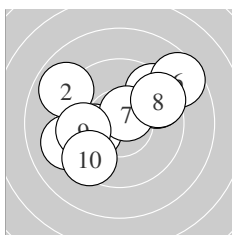
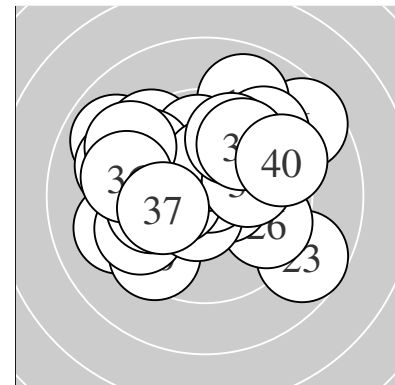

Serie 1:
 9.2 ← 8.9 ↘ 9.5 ↗ 9.5 ↗ 10.1 ←
 8.6 ↗ 10.6 * 9.5 ↗ 9.7 ← 9.4 ↘
 beste Teiler 97.4 (7.) 217.2 (5.) 301.8 (9.)
 Trefferlage 0.18 mm links, 0.76 mm hoch
 Streuwert 2.83, horizontal: 3.40, vertikal: 2.10

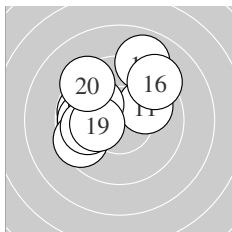

Serie 2:
 10.0 ↗ 9.8 ← 8.9 ↑ 9.8 ← 10.0 ↘
 9.3 ↗ 9.5 ← 9.9 ← 10.2 * 9.4 ↘
 beste Teiler 185.6 (19.) 229.0 (15.) 238.4 (11.)
 Trefferlage 1.09 mm links, 1.14 mm hoch
 Streuwert 2.17, horizontal: 2.37, vertikal: 1.93

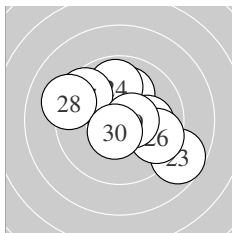

Serie 3:
 10.5 * 10.1 ↑ 8.7 ↘ 9.9 ↑ 10.1 →
 9.6 ↘ 9.6 ↘ 9.2 ← 10.6 * 10.5 *
 beste Teiler 98.0 (29.) 101.7 (30.) 114.1 (21.)
 Trefferlage 0.46 mm rechts, 0.37 mm hoch
 Streuwert 2.24, horizontal: 2.61, vertikal: 1.78

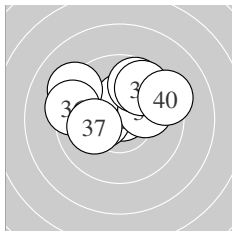

Serie 4:
 10.8 * 10.4 * 10.3 * 10.1 → 9.2 ↘
 9.4 ← 10.1 ← 9.7 ↑ 9.7 ↗ 9.3 ↗
 beste Teiler 49.2 (31.) 140.3 (32.) 153.5 (33.)
 Trefferlage 0.16 mm links, 1.23 mm hoch
 Streuwert 1.96, horizontal: 2.53, vertikal: 1.15

Unterschrift des Schützen

Ergebnis: **384** (399.8)
 Serien: 94 96 96 98
 Zähler: 24 16 0 0 0 0 0 0 0 0
 Innenzehner: 16
 weiteste: 495 (15), 483 (5), 481 (4)
 beste Teiler 51.8 (31.) 83.7 (19.) 95.4 (29.)
 Trefferlage 0.21 mm rechts, 0.66 mm tief
 Streuwert 1.82, horizontal: 1.85, vertikal: 1.80

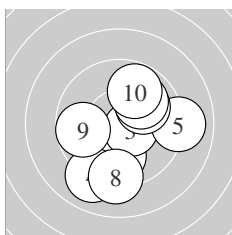
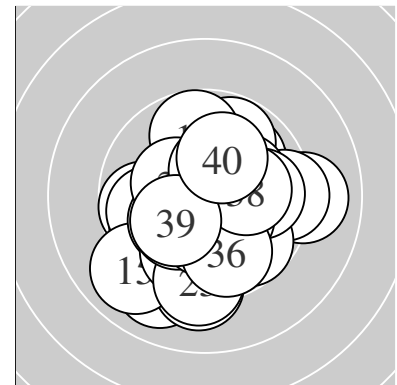

Serie 1:
 10.1 ↙ 9.9 ↓ 10.5 * 9.0 ↘ 9.0 →
 10.0 ↗ 10.0 ↗ 9.2 ↓ 9.7 ← 9.8 ↗
 beste Teiler 102.8 (3.) 204.8 (1.) 234.1 (6.)
 Trefferlage 0.37 mm rechts, 0.83 mm tief
 Streuwert 2.35, horizontal: 2.28, vertikal: 2.42

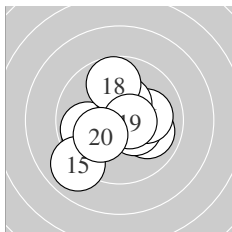

Serie 2:
 9.8 ↙ 10.0 ↘ 10.4 * 9.9 ← 9.0 ↘
 10.1 → 10.4 * 9.7 ↑ 10.6 * 10.2 *
 beste Teiler 83.7 (19.) 138.3 (13.) 141.0 (17.)
 Trefferlage 0.37 mm links, 0.41 mm tief
 Streuwert 1.91, horizontal: 2.06, vertikal: 1.75

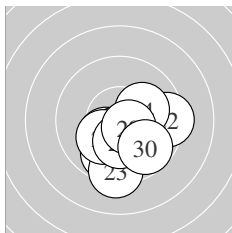

Serie 3:
 9.8 ↘ 9.4 → 9.3 ↓ 10.1 ↗ 10.3 *
 10.5 * 10.2 * 10.3 * 10.6 * 9.7 ↘
 beste Teiler 95.4 (29.) 113.4 (26.) 164.7 (25.)
 Trefferlage 0.46 mm rechts, 1.42 mm tief
 Streuwert 1.55, horizontal: 1.68, vertikal: 1.41

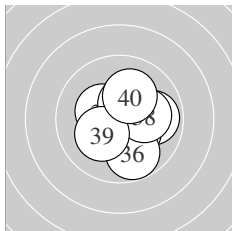

Serie 4:
 10.7 * 10.5 * 9.9 → 10.3 * 10.3 *
 9.8 ↓ 10.4 * 10.1 → 10.2 * 10.1 ↗
 beste Teiler 51.8 (31.) 118.8 (32.) 133.7 (37.)
 Trefferlage 0.39 mm rechts, 0.01 mm hoch
 Streuwert 1.39, horizontal: 1.43, vertikal: 1.34

Unterschrift des Schützen

Ergebnis: **379** (396.0)
 Serien: 92 95 98 94
 Zähler: 20 19 1 0 0 0 0 0 0 0
 Innenzehner: 13
 weiteste: 725 (13), 499 (3), 480 (15)
 beste Teiler 17.6 (28.) 62.8 (10.) 110.9 (34.)
 Trefferlage 0.14 mm rechts, 0.10 mm hoch
 Streuwert 2.11, horizontal: 2.68, vertikal: 1.31

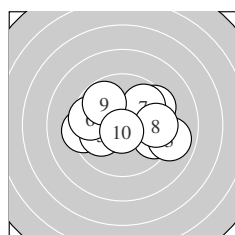
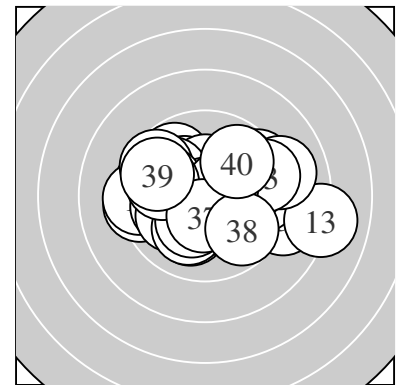

Serie 1:
 9.6 → 9.5 ↗ 9.0 → 9.3 ← 10.0 ←
 9.6 ← 9.8 ↖ 9.6 → 9.8 ↘ 10.7 *
 beste Teiler 62.8 (10.) 236.6 (5.) 289.5 (7.)
 Trefferlage 0.53 mm rechts, 0.20 mm hoch
 Streuwert 2.47, horizontal: 3.20, vertikal: 1.38

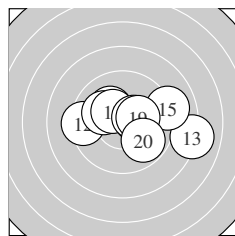

Serie 2:
 10.2 * 9.3 ← 8.1 → 10.4 * 9.0 →
 10.1 ↖ 10.4 * 10.5 * 10.3 * 9.8 ↘
 beste Teiler 123.5 (18.) 141.2 (14.) 148.6 (17.)
 Trefferlage 0.96 mm rechts, 0.26 mm hoch
 Streuwert 2.43, horizontal: 3.25, vertikal: 1.14

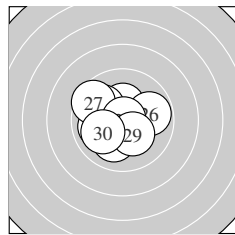

Serie 3:
 10.1 ↓ 10.3 * 10.0 ↖ 10.0 ← 10.2 *
 9.8 → 9.6 ↖ 10.9 * 10.3 * 10.0 ←
 beste Teiler 17.6 (28.) 153.0 (22.) 174.6 (29.)
 Trefferlage 0.81 mm links, 0.03 mm tief
 Streuwert 1.57, horizontal: 1.78, vertikal: 1.34

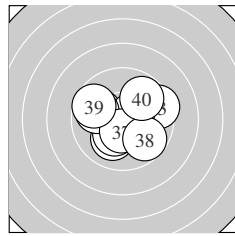

Serie 4:
 9.9 ↖ 10.1 ↓ 9.4 → 10.5 * 10.3 *
 9.9 ← 10.5 * 9.7 ↘ 9.7 ↖ 9.8 ↗
 beste Teiler 110.9 (34.) 122.5 (37.) 173.1 (35.)
 Trefferlage 0.10 mm links, 0.00 mm
 Streuwert 1.92, horizontal: 2.25, vertikal: 1.53

Unterschrift des Schützen

Meyton Elektronik

Ergebnis: **377** (393.4)
 Serien: 94 94 97 92
 Zähler: 19 19 2 0 0 0 0 0 0 0
 Innenzehner: 12
 weiteste: 559 (10), 514 (36), 493 (32)
 beste Teiler 21.2 (17.) 57.0 (6.) 68.0 (29.)
 Trefferlage 0.48 mm links, 0.50 mm hoch
 Streuwert 2.20, horizontal: 2.41, vertikal: 1.96

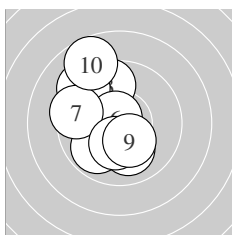
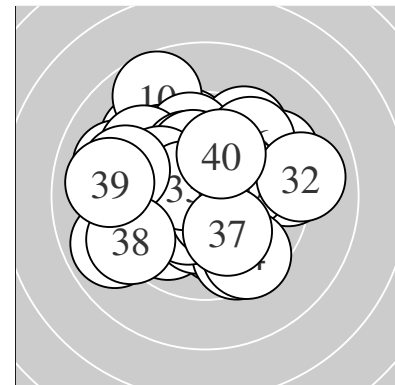

Serie 1:
 9.9 ↘ 10.0 ↓ 9.6 ↑ 10.4 * 9.3 ↖
 10.7 * 9.5 ← 10.3 * 10.3 * 8.7 ↑
 beste Teiler 57.0 (6.) 141.1 (4.) 167.4 (9.)
 Trefferlage 1.05 mm links, 0.39 mm hoch
 Streuwert 2.14, horizontal: 1.61, vertikal: 2.56

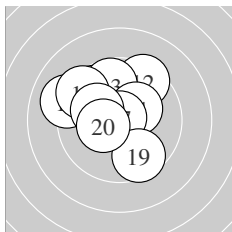

Serie 2:
 9.7 ↖ 9.4 ↗ 9.7 ↑ 10.3 * 9.1 ↖
 9.4 ↖ 10.9 * 10.1 ↖ 9.6 ↓ 10.4 *
 beste Teiler 21.2 (17.) 145.7 (20.) 167.2 (14.)
 Trefferlage 0.87 mm links, 1.10 mm hoch
 Streuwert 2.00, horizontal: 2.12, vertikal: 1.87

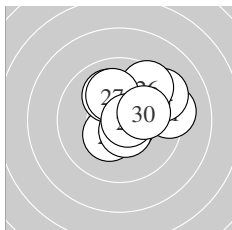

Serie 3:
 9.3 → 10.4 * 10.6 * 9.3 ↗ 10.1 ↖
 9.5 ↗ 10.1 ↑ 10.6 * 10.7 * 10.1 →
 beste Teiler 68.0 (29.) 86.4 (23.) 100.7 (28.)
 Trefferlage 1.15 mm rechts, 0.76 mm hoch
 Streuwert 1.62, horizontal: 1.80, vertikal: 1.42

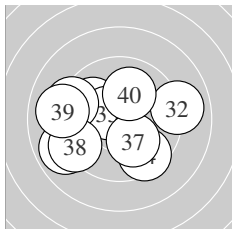

Serie 4:
 9.9 ↖ 9.0 → 10.5 * 9.5 ↓ 9.3 ↖
 8.9 ↖ 10.1 ↓ 9.2 ↖ 9.0 ← 10.0 ↑
 beste Teiler 113.6 (33.) 210.8 (37.) 226.9 (40.)
 Trefferlage 1.15 mm links, 0.24 mm tief
 Streuwert 2.67, horizontal: 3.28, vertikal: 1.87

Unterschrift des Schützen

Meyton Elektronik

Ergebnis: **392** (410.9)
 Serien: 98 98 97 99
 Zähler: 32 8 0 0 0 0 0 0 0 0
 Innenzehner: 28
 weiteste: 353 (22), 315 (23), 309 (16)
 beste Teiler 6.0 (19.) 13.3 (26.) 50.8 (8.)
 Trefferlage 0.88 mm links, 0.14 mm hoch
 Streuwert 1.19, horizontal: 1.20, vertikal: 1.19

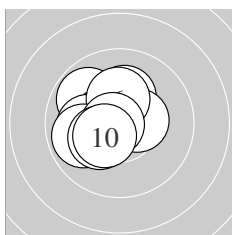
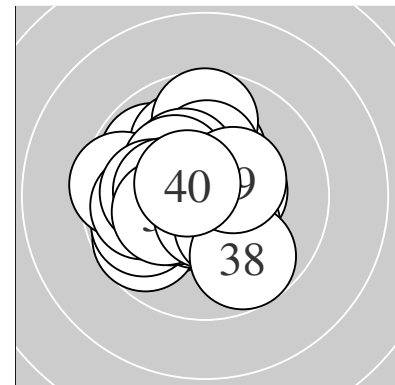

Serie 1:
 10.2 * 9.8 ↘ 10.5 * 10.6 * 10.1 ←
 10.3 * 9.9 ← 10.8 * 10.3 * 10.4 *
 beste Teiler 50.8 (8.) 86.2 (4.) 125.6 (3.)
 Trefferlage 0.92 mm links, 0.27 mm hoch
 Streuwert 1.17, horizontal: 1.22, vertikal: 1.12

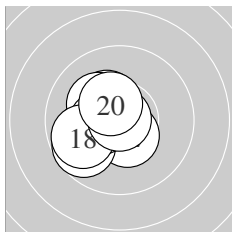

Serie 2:
 10.7 * 10.5 * 10.3 * 10.0 ← 10.2 *
 9.7 ← 10.4 * 9.8 ← 10.9 * 10.4 *
 beste Teiler 6.0 (19.) 51.1 (11.) 121.1 (12.)
 Trefferlage 1.11 mm links, 0.19 mm tief
 Streuwert 1.09, horizontal: 1.10, vertikal: 1.08

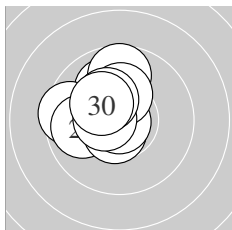

Serie 3:
 10.0 ↖ 9.5 ← 9.7 ↑ 9.9 ← 10.6 *
 10.9 * 10.2 * 10.5 * 10.3 * 10.3 *
 beste Teiler 13.3 (26.) 88.7 (25.) 104.2 (28.)
 Trefferlage 1.05 mm links, 0.88 mm hoch
 Streuwert 1.22, horizontal: 1.17, vertikal: 1.27

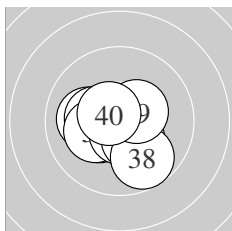

Serie 4:
 10.3 * 10.7 * 10.1 ← 10.3 * 10.2 *
 10.6 * 10.3 * 9.7 ↘ 10.4 * 10.6 *
 beste Teiler 60.1 (32.) 83.3 (36.) 91.8 (40.)
 Trefferlage 0.43 mm links, 0.40 mm tief
 Streuwert 1.19, horizontal: 1.34, vertikal: 1.01

Unterschrift des Schützen

Meyton Elektronik

Ergebnis: **398** (415.3)
 Serien: 99 100 100 99
 Zähler: 38 2 0 0 0 0 0 0 0 0
 Innenzehner: 34
 weiteste: 462 (2), 429 (31), 237 (7)
 beste Teiler 21.6 (17.) 41.1 (12.) 50.0 (14.)
 Trefferlage 0.01 mm links, 0.15 mm hoch
 Streuwert 1.21, horizontal: 1.39, vertikal: 0.98

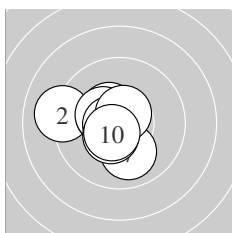
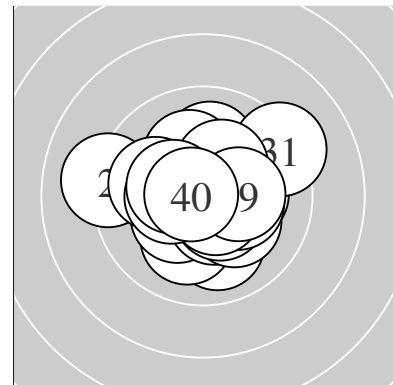

Serie 1:
 10.7 * 9.1 ← 10.4 * 10.4 * 10.4 *
 10.7 * 10.0 ↓ 10.5 * 10.6 * 10.6 *
 beste Teiler 55.0 (1.) 71.5 (6.) 82.6 (9.)
 Trefferlage 0.92 mm links, 0.01 mm hoch
 Streuwert 1.25, horizontal: 1.43, vertikal: 1.05

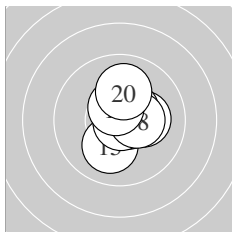

Serie 2:
 10.2 * 10.8 * 10.5 * 10.8 * 10.1 ↘
 10.7 * 10.9 * 10.4 * 10.5 * 10.0 ↑
 beste Teiler 21.6 (17.) 41.1 (12.) 50.0 (14.)
 Trefferlage 0.44 mm rechts, 0.27 mm hoch
 Streuwert 0.94, horizontal: 0.79, vertikal: 1.08

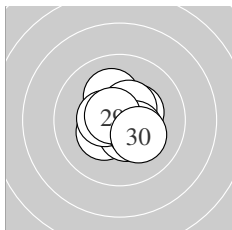

Serie 3:
 10.7 * 10.2 * 10.4 * 10.3 * 10.5 *
 10.5 * 10.5 * 10.4 * 10.7 * 10.2 *
 beste Teiler 66.0 (29.) 73.4 (21.) 118.0 (26.)
 Trefferlage 0.09 mm rechts, 0.01 mm hoch
 Streuwert 1.03, horizontal: 1.07, vertikal: 0.99

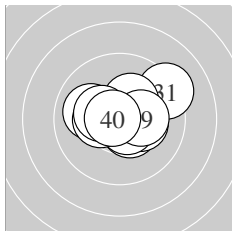

Serie 4:
 9.2 ↗ 10.5 * 10.3 * 10.6 * 10.3 *
 10.0 ← 10.3 * 10.4 * 10.3 * 10.7 *
 beste Teiler 57.4 (40.) 84.8 (34.) 118.1 (32.)
 Trefferlage 0.35 mm rechts, 0.29 mm hoch
 Streuwert 1.44, horizontal: 1.81, vertikal: 0.93

Unterschrift des Schützen

Ergebnis: **391** (407.7)
 Serien: 98 97 98 98
 Zähler: 31 9 0 0 0 0 0 0 0 0
 Innenzehner: 24
 weiteste: 448 (16), 431 (34), 425 (24)
 beste Teiler 14.5 (19.) 54.2 (31.) 58.0 (39.)
 Trefferlage 0.48 mm rechts, 0.73 mm hoch
 Streuwert 1.43, horizontal: 1.44, vertikal: 1.41

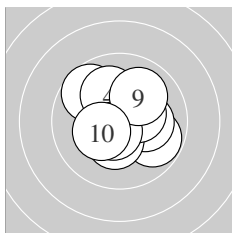
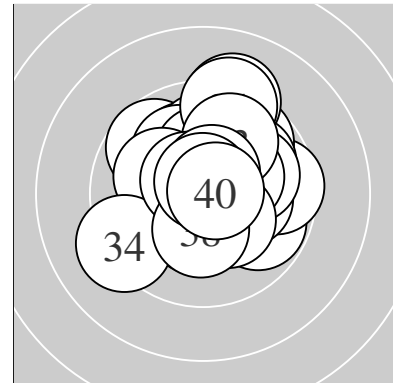

Serie 1:
 9.8 ↘ 10.5 * 9.7 ↘ 10.1 ↗ 10.2 *
 10.3 * 10.4 * 10.6 * 10.0 ↗ 10.3 *
 beste Teiler 91.2 (8.) 110.1 (2.) 147.8 (7.)
 Trefferlage 0.27 mm rechts, 0.30 mm hoch
 Streuwert 1.49, horizontal: 1.57, vertikal: 1.40

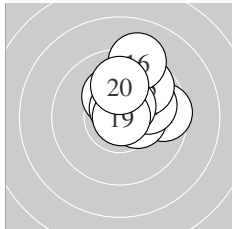

Serie 2:
 9.6 → 10.3 * 10.4 * 10.0 → 9.7 ↗
 9.2 ↑ 10.7 * 10.6 * 10.9 * 10.0 ↑
 beste Teiler 14.5 (19.) 68.7 (17.) 100.9 (18.)
 Trefferlage 1.02 mm rechts, 1.33 mm hoch
 Streuwert 1.31, horizontal: 1.26, vertikal: 1.36

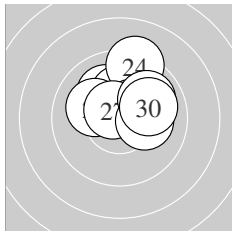

Serie 3:
 10.1 ↘ 10.2 * 10.3 * 9.3 ↑ 10.5 *
 10.1 ↘ 10.6 * 10.2 * 9.9 ↗ 10.0 →
 beste Teiler 81.6 (27.) 120.8 (25.) 172.6 (23.)
 Trefferlage 0.64 mm rechts, 1.26 mm hoch
 Streuwert 1.32, horizontal: 1.45, vertikal: 1.17

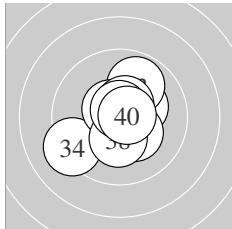

Serie 4:
 10.7 * 10.3 * 9.9 ↗ 9.2 ↙ 10.6 *
 10.3 * 10.5 * 10.3 * 10.7 * 10.7 *
 beste Teiler 54.2 (31.) 58.0 (39.) 59.6 (40.)
 Trefferlage 0.00 mm , 0.02 mm hoch
 Streuwert 1.44, horizontal: 1.48, vertikal: 1.40

Unterschrift des Schützen

Meyton Elektronik

Ergebnis: **382** (399.1)
 Serien: 96 96 94 96
 Zähler: 23 16 1 0 0 0 0 0 0 0
 Innenzehner: 13
 weiteste: 719 (27), 464 (4), 418 (3)
 beste Teiler 72.8 (10.) 79.2 (7.) 92.4 (21.)
 Trefferlage 0.05 mm rechts, 0.13 mm hoch
 Streuwert 1.94, horizontal: 1.91, vertikal: 1.98

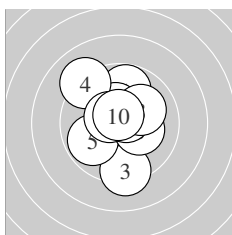
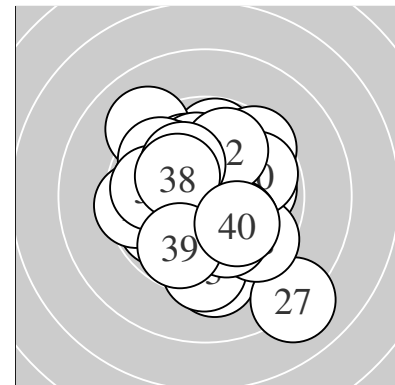

Serie 1:
 9.8 ↑ 10.4 * 9.3 ↓ 9.1 ↘ 9.8 ↙
 10.2 * 10.6 * 10.1 ↗ 10.5 * 10.7 *
 beste Teiler 72.8 (10.) 79.2 (7.) 104.1 (9.)
 Trefferlage 0.15 mm links, 0.45 mm hoch
 Streuwert 1.91, horizontal: 1.59, vertikal: 2.18

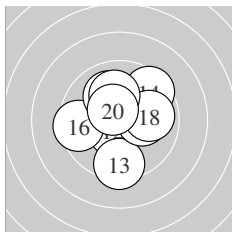

Serie 2:
 10.0 → 10.5 * 9.4 ↓ 9.5 ↗ 10.2 *
 9.5 ← 10.0 ↘ 9.9 → 10.1 ↑ 10.5 *
 beste Teiler 106.0 (12.) 109.8 (20.) 198.0 (15.)
 Trefferlage 0.32 mm rechts, 0.32 mm hoch
 Streuwert 1.95, horizontal: 2.03, vertikal: 1.87

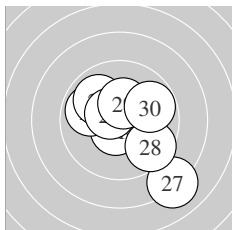

Serie 3:
 10.6 * 10.1 → 10.1 ↘ 9.9 ↖ 9.9 ↘
 10.5 * 8.1 ↘ 9.5 ↘ 10.4 * 9.8 →
 beste Teiler 92.4 (21.) 101.5 (26.) 150.4 (29.)
 Trefferlage 0.48 mm rechts, 0.11 mm tief
 Streuwert 2.33, horizontal: 2.41, vertikal: 2.24

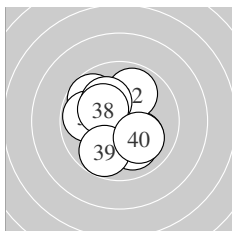

Serie 4:
 10.1 ↘ 9.9 ↑ 10.4 * 9.7 ↘ 9.8 ←
 10.1 ↘ 10.0 ↘ 10.2 * 9.8 ↙ 10.1 ↘
 beste Teiler 147.1 (33.) 179.2 (38.) 203.0 (36.)
 Trefferlage 0.42 mm links, 0.13 mm tief
 Streuwert 1.75, horizontal: 1.67, vertikal: 1.83

Unterschrift des Schützen

Meyton Elektronik

Ergebnis: **385** (403.1)
 Serien: 96 97 96 96
 Zähler: 26 13 1 0 0 0 0 0 0 0
 Innenzehner: 19
 weiteste: 562 (22), 424 (39), 395 (32)
 beste Teiler 37.1 (27.) 56.2 (35.) 88.0 (33.)
 Trefferlage 0.07 mm rechts, 0.32 mm hoch
 Streuwert 1.76, horizontal: 1.86, vertikal: 1.64

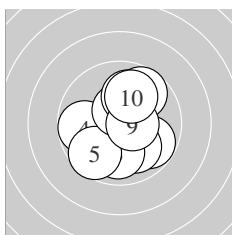
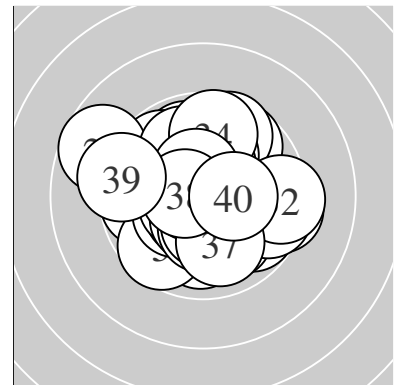

Serie 1:
 9.8 ↘ 10.0 ↘ 10.0 ↓ 9.8 ← 9.6 ↙
 9.7 ↗ 10.5 * 10.0 ↑ 10.5 * 10.0 ↑
 beste Teiler 109.3 (7.) 109.3 (9.) 236.2 (8.)
 Trefferlage 0.30 mm rechts, 0.08 mm tief
 Streuwert 1.86, horizontal: 1.70, vertikal: 2.02

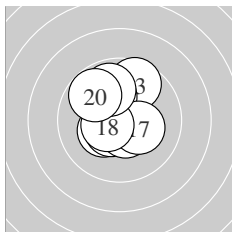

Serie 2:
 10.3 * 10.2 * 9.6 ↑ 10.1 ↖ 10.5 *
 10.5 * 10.3 * 10.5 * 9.9 ↖ 9.8 ↘
 beste Teiler 108.2 (16.) 110.6 (15.) 110.8 (18.)
 Trefferlage 0.46 mm links, 0.75 mm hoch
 Streuwert 1.43, horizontal: 1.19, vertikal: 1.63

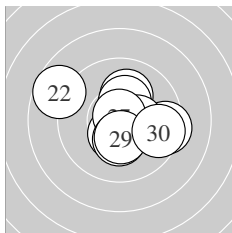

Serie 3:
 9.4 → 8.7 ↖ 10.1 ↑ 10.3 * 10.4 *
 10.5 * 10.8 * 10.3 * 10.4 * 9.6 →
 beste Teiler 37.1 (27.) 122.9 (26.) 145.3 (29.)
 Trefferlage 0.41 mm rechts, 0.04 mm hoch
 Streuwert 2.01, horizontal: 2.43, vertikal: 1.48

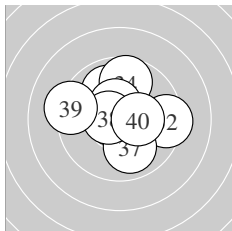

Serie 4:
 9.9 ↖ 9.4 → 10.6 * 9.7 ↑ 10.7 *
 10.5 * 10.0 ↓ 10.6 * 9.3 ← 10.3 *
 beste Teiler 56.2 (35.) 88.0 (33.) 92.7 (38.)
 Trefferlage 0.04 mm rechts, 0.57 mm hoch
 Streuwert 1.81, horizontal: 2.07, vertikal: 1.49

Unterschrift des Schützen

Meyton Elektronik

Ergebnis:	380	(397.5)
Serien:	94 95 96 95	
Zähler:	21 18 1 0 0 0 0 0 0 0	
Innenzehner:	14	
weiteste:	689 (6), 490 (33), 463 (1)	
beste Teiler	18.4 (7.) 89.0 (16.) 89.1 (17.)	
Trefferlage	0.43 mm rechts, 0.22 mm hoch	
Streuwert	2.00, horizontal: 2.15, vertikal: 1.83	

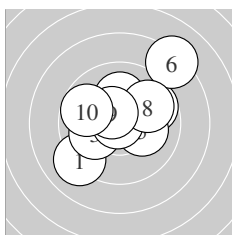
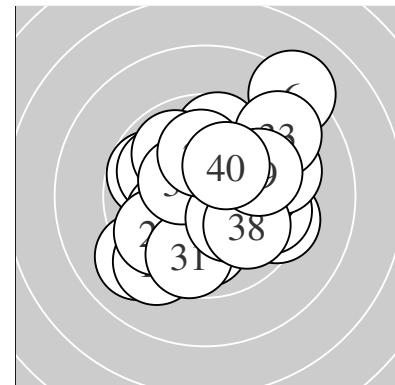

Serie 1:	9.1 ↙	9.7 ↗	10.0 ↙	10.1 ↑	10.1 →
	8.2 ↗	10.9 *	9.8 ↗	10.5 *	9.7 ↖
beste Teiler	18.4 (7.)	111.6 (9.)	202.4 (5.)		
Trefferlage	0.24 mm rechts, 0.77 mm hoch				
Streuwert	2.41, horizontal: 2.61, vertikal: 2.19				

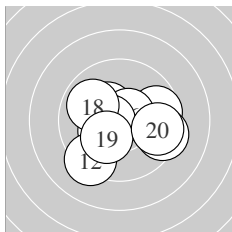

Serie 2:	10.3 *	9.3 ↙	10.4 *	9.7 →	9.4 →
	10.6 *	10.6 *	9.9 ↘	10.2 *	9.6 →
beste Teiler	89.0 (16.)	89.1 (17.)	145.6 (13.)		
Trefferlage	0.16 mm rechts, 0.43 mm tief				
Streuwert	1.95, horizontal: 2.38, vertikal: 1.41				

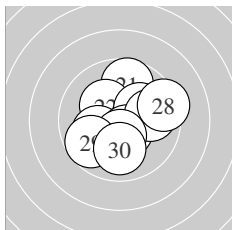

Serie 3:	9.7 ↑	10.3 *	10.1 ↙	10.2 *	10.5 *
	9.9 →	10.4 *	9.4 →	9.7 ↙	10.0 ↓
beste Teiler	112.0 (25.)	133.1 (27.)	173.2 (22.)		
Trefferlage	0.39 mm rechts, 0.05 mm tief				
Streuwert	1.84, horizontal: 1.95, vertikal: 1.73				

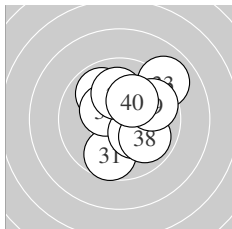

Serie 4:	9.7 ↓	9.9 ↘	9.0 ↗	10.4 *	10.3 *
	10.0 →	10.1 ↑	9.9 ↘	9.7 →	10.2 *
beste Teiler	143.1 (34.)	169.1 (35.)	189.7 (40.)		
Trefferlage	0.94 mm rechts, 0.63 mm hoch				
Streuwert	1.87, horizontal: 1.81, vertikal: 1.93				

Unterschrift des Schützen

Meyton Elektronik

Ergebnis: **390** (409.1)
 Serien: 100 98 95 97
 Zähler: 30 10 0 0 0 0 0 0 0 0
 Innenzehner: 24
 weiteste: 341 (27), 334 (20), 309 (24)
 beste Teiler 55.0 (33.) 63.9 (16.) 80.8 (2.)
 Trefferlage 0.01 mm links, 0.55 mm hoch
 Streuwert 1.37, horizontal: 1.51, vertikal: 1.21

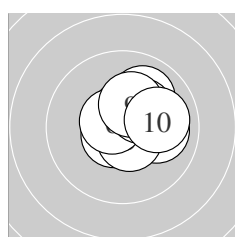
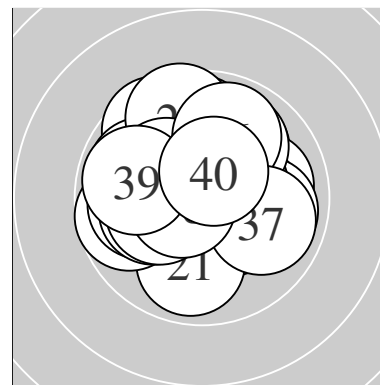

Serie 1:
 10.5 * 10.6 * 10.6 * 10.0 → 10.6 *
 10.6 * 10.0 ↗ 10.3 * 10.3 * 10.0 →
 beste Teiler 80.8 (2.) 82.3 (6.) 87.0 (3.)
 Trefferlage 0.78 mm rechts, 0.57 mm hoch
 Streuwert 0.99, horizontal: 1.08, vertikal: 0.89

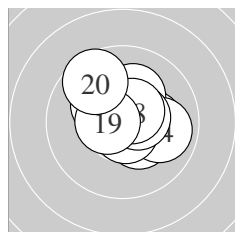

Serie 2:
 10.2 * 10.4 * 10.2 * 9.9 → 10.2 *
 10.7 * 10.5 * 10.6 * 10.5 * 9.6 ↘
 beste Teiler 63.9 (16.) 99.3 (18.) 103.0 (19.)
 Trefferlage 0.39 mm rechts, 0.47 mm hoch
 Streuwert 1.30, horizontal: 1.42, vertikal: 1.17

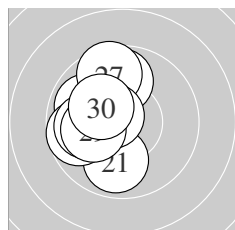

Serie 3:
 9.9 ↓ 9.9 ↖ 9.8 ↑ 9.7 ← 10.6 *
 10.0 ← 9.6 ↗ 10.6 * 10.1 ← 10.2 *
 beste Teiler 87.3 (28.) 100.1 (25.) 180.6 (30.)
 Trefferlage 1.45 mm links, 0.49 mm hoch
 Streuwert 1.40, horizontal: 0.97, vertikal: 1.72

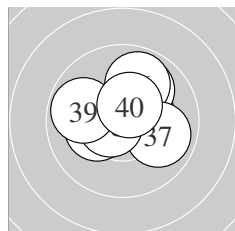

Serie 4:
 10.4 * 10.4 * 10.7 * 10.2 * 10.0 ↗
 9.9 ↗ 9.9 → 10.6 * 9.8 ← 10.5 *
 beste Teiler 55.0 (33.) 86.8 (38.) 120.0 (40.)
 Trefferlage 0.23 mm rechts, 0.68 mm hoch
 Streuwert 1.35, horizontal: 1.57, vertikal: 1.08

Unterschrift des Schützen

Meyton Elektronik

Ergebnis: **356** (372.9)
 Serien: 89 88 91 88
 Zähler: 11 14 15 0 0 0 0 0 0
 Innenzehner: 7
 weiteste: 740 (11), 705 (2), 701 (34)
 beste Teiler 80.0 (8.) 129.2 (18.) 173.7 (16.)
 Trefferlage 1.00 mm links, 0.28 mm tief
 Streuwert 3.10, horizontal: 3.55, vertikal: 2.57

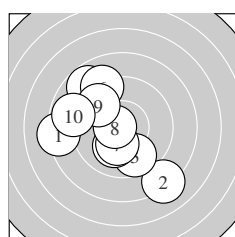
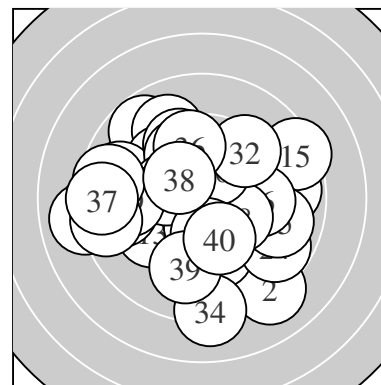

Serie 1:
 8.3 ← 8.1 ↘ 9.7 ↘ 8.8 ↘ 10.1 ↘
 9.1 ↘ 10.2 * 10.6 * 9.6 ↘ 8.8 ←
 beste Teiler 80.0 (8.) 180.5 (7.) 213.9 (5.)
 Trefferlage 1.67 mm links, 0.10 mm tief
 Streuwert 3.13, horizontal: 3.12, vertikal: 3.15

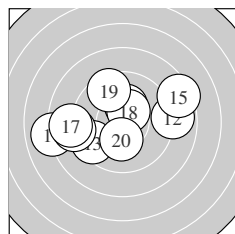

Serie 2:
 8.0 ← 8.9 → 9.5 ↖ 8.9 ← 8.4 →
 10.3 * 8.8 ← 10.4 * 9.5 ↘ 10.2 *
 beste Teiler 129.2 (18.) 173.7 (16.) 179.4 (20.)
 Trefferlage 1.03 mm links, 0.30 mm hoch
 Streuwert 3.35, horizontal: 4.35, vertikal: 1.89

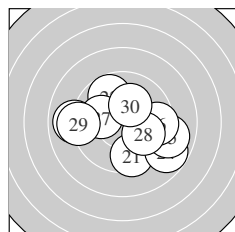

Serie 3:
 9.5 ↘ 9.7 ↘ 8.9 ← 8.8 ↘ 9.0 →
 9.5 → 10.0 ← 10.0 ↘ 9.1 ← 10.2 *
 beste Teiler 193.8 (30.) 227.2 (27.) 247.9 (28.)
 Trefferlage 0.35 mm rechts, 0.44 mm tief
 Streuwert 2.85, horizontal: 3.55, vertikal: 1.92

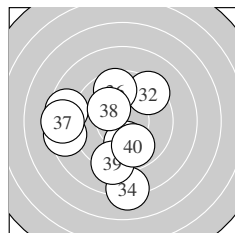

Serie 4:
 8.6 ← 9.4 ↗ 8.5 ← 8.1 ↓ 10.0 ↓
 9.6 ↑ 8.5 ← 10.2 * 9.2 ↓ 9.9 ↘
 beste Teiler 189.1 (38.) 226.8 (35.) 275.4 (40.)
 Trefferlage 1.67 mm links, 0.90 mm tief
 Streuwert 3.23, horizontal: 3.21, vertikal: 3.24

Unterschrift des Schützen

Meyton Elektronik