

Ergebnis: **384.3** (366)
 Serien: 94.7 95.2 95.1 99.3
 Zähler: 12 23 4 1 0 0 0 0 0 0
 Innenzehner: 8
 weiteste: 777 (16), 535 (29), 529 (30)
 beste Teiler 25.5 (5.) 54.4 (34.) 97.7 (25.)
 Trefferlage 0.65 mm rechts, 0.33 mm hoch
 Streuwert 2.61, horizontal: 2.98, vertikal: 2.17

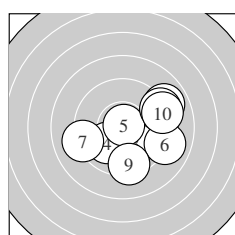

Serie 1:
 8.9 ↗ 9.3 → 10.0 ↘ 10.0 ✓ 10.9 *
 9.0 → 9.1 ← 9.1 → 9.3 ↓ 9.1 →
 beste Teiler 25.5 (5.) 228.4 (3.) 238.3 (4.)
 Trefferlage 1.76 mm rechts, 0.35 mm tief
 Streuwert 2.63, horizontal: 3.06, vertikal: 2.11

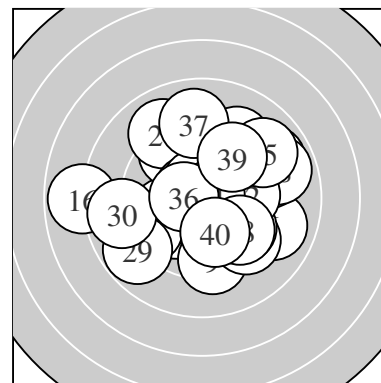
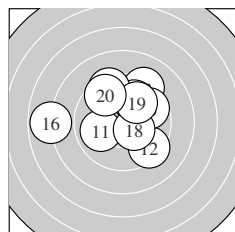

Serie 2:
 9.9 ← 9.4 ↘ 9.2 ↗ 9.9 ↗ 9.7 ↗
 7.8 ← 9.4 ↖ 10.4 * 9.9 ↗ 9.6 ↘
 beste Teiler 148.1 (18.) 252.3 (11.) 260.0 (19.)
 Trefferlage 0.15 mm links, 1.16 mm hoch
 Streuwert 2.79, horizontal: 3.30, vertikal: 2.18

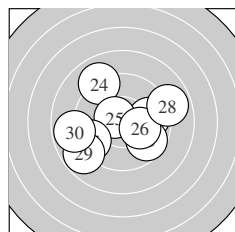

Serie 3:
 10.0 → 9.8 → 9.7 ↘ 9.0 ↘ 10.6 *
 10.2 * 9.3 ← 8.9 → 8.8 ✓ 8.8 ←
 beste Teiler 97.7 (25.) 198.9 (26.) 240.6 (21.)
 Trefferlage 0.17 mm links, 0.25 mm tief
 Streuwert 2.91, horizontal: 3.51, vertikal: 2.14

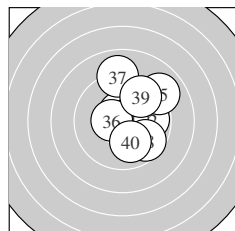

Serie 4:
 10.4 * 9.8 → 10.6 * 10.7 * 9.0 ↗
 10.5 * 9.0 ↑ 9.7 ↘ 9.6 ↗ 10.0 ↓
 beste Teiler 54.4 (34.) 98.3 (33.) 118.2 (36.)
 Trefferlage 1.18 mm rechts, 0.78 mm hoch
 Streuwert 1.93, horizontal: 1.63, vertikal: 2.20

Unterschrift des Schützen

Meyton Elektronik

Ergebnis: **601.8** (575)
 Serien: 103.2 101.3 97.1 100.5 100.1 99.6
 Zähler: 36 23 1 0 0 0 0 0 0
 Innenzehner: 30
 weiteste: 660 (52), 469 (18), 442 (58)
 beste Teiler 41.1 (33.) 45.2 (7.) 70.2 (9.)
 Trefferlage 0.02 mm links, 0.26 mm hoch
 Streuwert 1.85, horizontal: 2.37, vertikal: 1.11

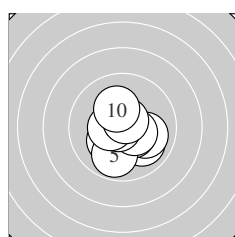
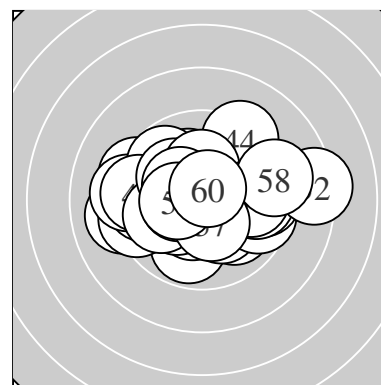

Serie 1:
 10.0 ↘ 10.0 → 10.5 * 10.2 * 9.9 ↓
 10.4 * 10.8 * 10.5 * 10.7 * 10.2 *
 beste Teiler 45.2 (7.) 70.2 (9.) 118.0 (8.)
 Trefferlage 0.22 mm rechts, 0.53 mm tief
 Streuwert 1.24, horizontal: 1.26, vertikal: 1.21

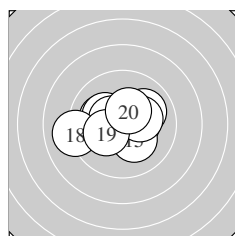

Serie 2:
 10.1 ↖ 10.4 * 10.2 * 10.5 * 10.2 *
 10.0 ↗ 10.2 * 9.1 ← 10.2 * 10.4 *
 beste Teiler 118.1 (14.) 141.9 (20.) 142.0 (12.)
 Trefferlage 0.41 mm links, 0.18 mm hoch
 Streuwert 1.65, horizontal: 2.13, vertikal: 0.95

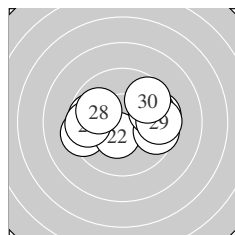

Serie 3:
 9.4 ← 10.4 * 9.7 ← 9.5 → 9.6 →
 9.8 → 9.6 ← 9.9 ↖ 9.5 → 9.7 ↗
 beste Teiler 138.9 (22.) 256.7 (28.) 299.8 (26.)
 Trefferlage 0.24 mm rechts, 0.21 mm hoch
 Streuwert 2.36, horizontal: 3.15, vertikal: 1.10

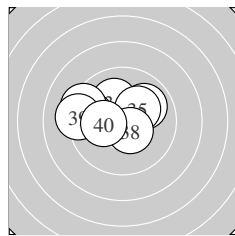

Serie 4:
 9.9 ↗ 10.6 * 10.8 * 10.1 ↖ 10.2 *
 9.7 ← 9.3 ↖ 10.5 * 9.2 ← 10.2 *
 beste Teiler 41.1 (33.) 82.8 (32.) 118.8 (38.)
 Trefferlage 0.97 mm links, 0.61 mm hoch
 Streuwert 1.70, horizontal: 2.24, vertikal: 0.89

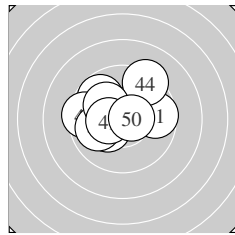

Serie 5:
 9.7 → 9.7 ↖ 10.6 * 9.3 ↗ 9.5 ←
 10.3 * 9.9 ← 10.1 ↖ 10.4 * 10.6 *
 beste Teiler 81.0 (43.) 87.5 (50.) 136.0 (49.)
 Trefferlage 0.63 mm links, 0.66 mm hoch
 Streuwert 1.82, horizontal: 2.17, vertikal: 1.38

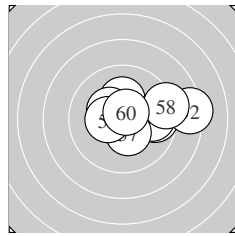

Serie 6:
 9.7 → 8.3 → 10.6 * 10.2 * 10.3 *
 9.8 → 10.4 * 9.2 → 10.4 * 10.7 *
 beste Teiler 73.7 (60.) 79.1 (53.) 143.1 (59.)
 Trefferlage 1.41 mm rechts, 0.41 mm hoch
 Streuwert 1.98, horizontal: 2.66, vertikal: 0.88

LG 60 ZR – Wertung – Junioren

StandNr: 117

Fankhauser,, Thomas #70804016

StartNr: 15

13. Januar 2019 10:39

SG_Fügenberg

Unterschrift des Schützen

Meyton Elektronik

Ergebnis: **601.1** (573)
 Serien: 98.9 101.1 97.6 101.4 100.6 101.5
 Zähler: 34 25 1 0 0 0 0 0 0
 Innenzehner: 24
 weiteste: 714 (22), 485 (17), 436 (5)
 beste Teiler 16.1 (30.) 28.0 (48.) 47.8 (15.)
 Trefferlage 0.48 mm links, 0.09 mm tief
 Streuwert 1.88, horizontal: 2.10, vertikal: 1.63

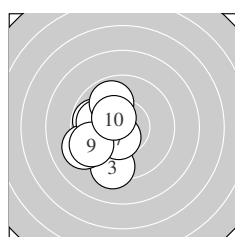
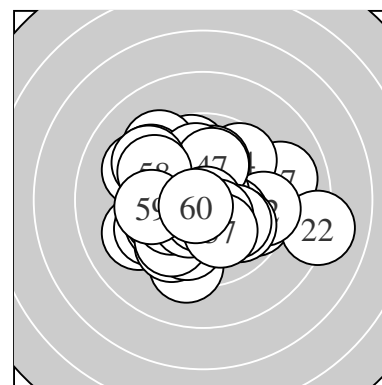

Serie 1:
 10.3 * 10.0 ↙ 9.3 ↓ 9.8 ↖ 9.2 ↙
 10.0 ↖ 10.5 * 9.9 ↘ 9.5 ↙ 10.4 *
 beste Teiler 109.5 (7.) 128.7 (10.) 166.2 (1.)
 Trefferlage 1.83 mm links, 0.48 mm tief
 Streuwert 1.59, horizontal: 1.15, vertikal: 1.93

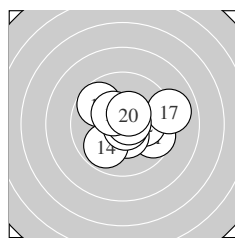

Serie 2:
 9.6 → 10.1 → 10.4 * 9.9 ↙ 10.8 *
 9.7 ↘ 9.0 → 10.7 * 10.4 * 10.5 *
 beste Teiler 47.8 (15.) 65.0 (18.) 121.4 (20.)
 Trefferlage 0.68 mm rechts, 0.06 mm hoch
 Streuwert 1.78, horizontal: 2.15, vertikal: 1.31

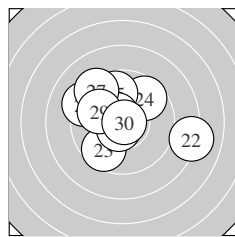

Serie 3:
 9.2 ↘ 8.1 → 9.6 ↙ 9.6 ↗ 9.8 ↑
 10.6 * 9.3 ↘ 10.6 * 9.9 ↖ 10.9 *
 beste Teiler 16.1 (30.) 81.4 (28.) 97.1 (26.)
 Trefferlage 0.32 mm links, 0.69 mm hoch
 Streuwert 2.58, horizontal: 3.06, vertikal: 1.98

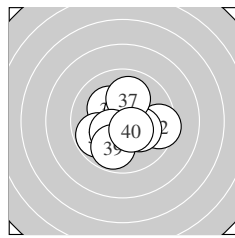

Serie 4:
 10.5 * 9.5 → 10.2 * 10.6 * 10.2 *
 9.8 ↙ 10.0 ↑ 10.3 * 9.8 ↓ 10.5 *
 beste Teiler 99.9 (34.) 123.0 (40.) 125.8 (31.)
 Trefferlage 0.11 mm rechts, 0.41 mm tief
 Streuwert 1.61, horizontal: 1.75, vertikal: 1.46

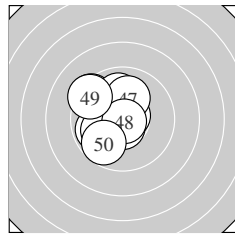

Serie 5:
 10.7 * 9.4 ↘ 9.9 ↙ 10.6 * 10.0 ↑
 10.0 ↙ 10.1 ↑ 10.8 * 9.4 ↖ 9.7 ↙
 beste Teiler 28.0 (48.) 65.5 (41.) 83.0 (44.)
 Trefferlage 1.20 mm links, 0.38 mm hoch
 Streuwert 1.65, horizontal: 1.53, vertikal: 1.77

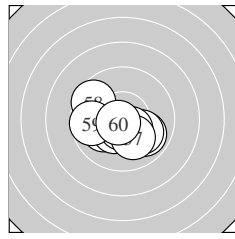

Serie 6:
 9.9 ↘ 10.1 ↙ 10.4 * 10.0 ↘ 10.6 *
 10.4 * 10.1 ↘ 9.6 ↖ 9.7 ↖ 10.7 *
 beste Teiler 57.4 (60.) 92.0 (55.) 127.2 (56.)
 Trefferlage 0.34 mm links, 0.80 mm tief
 Streuwert 1.50, horizontal: 1.88, vertikal: 0.98

Meyton Elektronik

LG 60 ZR – Wertung – Junioren

StandNr: 120

Unterpertinger,, Felix #70401045

StartNr: 16

13. Januar 2019 10:59

SG_Angerberg

Unterschrift des Schützen

Meyton Elektronik

Ergebnis:	609.0	(585)
Serien:	99.2	102.9 102.5 102.8 101.5 100.1
Zähler:	45	15 0 0 0 0 0 0 0 0
Innenzehner:	32	
weiteste:	486 (54), 444 (25), 393 (4)	
beste Teiler	18.8 (16.)	30.6 (38.) 49.7 (10.)
Trefferlage	0.18 mm rechts,	0.68 mm hoch
Streuwert	1.53, horizontal:	1.71, vertikal: 1.32

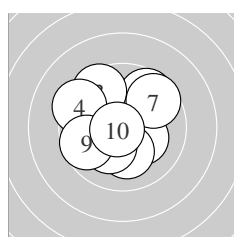
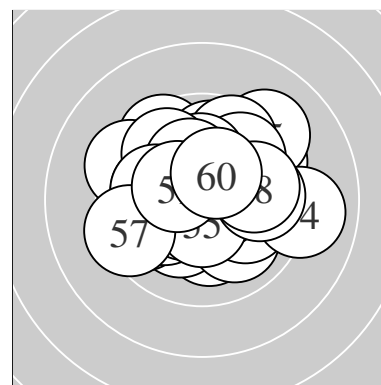

Serie 1:

9.7 ↗	10.0 ←	9.5 ↘	9.4 ↖	10.2 *
10.1 ↓	9.6 ↗	10.2 *	9.7 ↙	10.8 *
beste Teiler	49.7 (10.)	177.7 (5.)	190.8 (8.)	
Trefferlage	0.58 mm links, 0.41 mm hoch			
Streuwert	1.99, horizontal: 2.13, vertikal: 1.84			

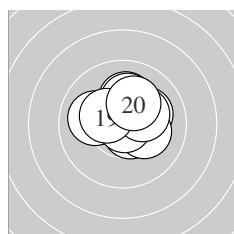

Serie 2:

10.0 ←	10.1 ↑	10.1 ↗	10.6 *	10.2 *
10.9 *	10.2 *	10.2 *	10.4 *	10.2 *
beste Teiler	18.8 (16.)	87.6 (14.)	148.0 (19.)	
Trefferlage	0.40 mm rechts, 0.72 mm hoch			
Streuwert	1.17, horizontal: 1.34, vertikal: 0.97			

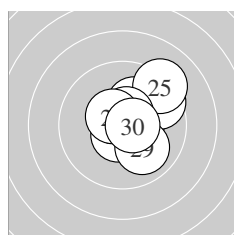

Serie 3:

10.2 *	10.5 *	9.6 ↗	10.7 *	9.2 ↗
10.6 *	10.6 *	10.5 *	10.0 ↘	10.6 *
beste Teiler	67.1 (24.)	82.0 (30.)	87.2 (27.)	
Trefferlage	0.92 mm rechts, 0.63 mm hoch			
Streuwert	1.39, horizontal: 1.35, vertikal: 1.42			

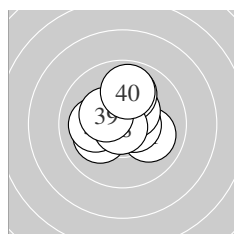

Serie 4:

10.0 ↘	10.6 *	10.1 ↙	10.6 *	10.4 *
10.0 ↑	10.1 ←	10.8 *	10.3 *	9.9 ↑
beste Teiler	30.6 (38.)	88.6 (32.)	94.3 (34.)	
Trefferlage	0.02 mm rechts, 0.48 mm hoch			
Streuwert	1.33, horizontal: 1.40, vertikal: 1.26			

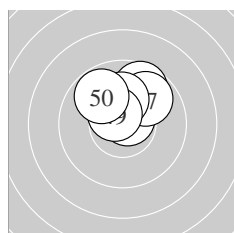

Serie 5:

10.2 *	10.5 *	10.0 ↘	10.7 *	10.2 *
9.7 ↗	9.8 ↗	10.1 ↑	10.5 *	9.8 ↘
beste Teiler	60.8 (44.)	104.8 (49.)	115.1 (42.)	
Trefferlage	0.07 mm rechts, 1.74 mm hoch			
Streuwert	0.96, horizontal: 1.15, vertikal: 0.74			

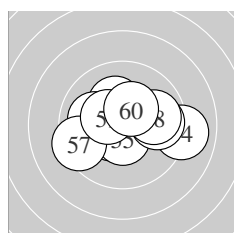

Serie 6:

10.5 *	10.2 *	10.0 ←	9.0 →	10.5 *
9.8 →	9.4 ↙	9.9 →	10.4 *	10.4 *
beste Teiler	107.0 (55.)	111.2 (51.)	138.7 (59.)	
Trefferlage	0.24 mm rechts, 0.11 mm hoch			
Streuwert	1.95, horizontal: 2.55, vertikal: 1.07			

Meyton Elektronik

LG 60 ZR – Wertung – Juniorinnen

StandNr: 119

Wachtler,, Manuela #70804069

StartNr: 17

13. Januar 2019 10:31

SG_Fügenberg

Unterschrift des Schützen

Meyton Elektronik

Ergebnis: **597.3** (570)
 Serien: 101.6 97.2 101.3 96.6 100.1 100.5
 Zähler: 34 22 4 0 0 0 0 0 0
 Innenzehner: 26
 weiteste: 606 (35), 597 (18), 541 (49)
 beste Teiler 13.4 (42.) 45.3 (6.) 57.4 (46.)
 Trefferlage 0.75 mm links, 0.05 mm hoch
 Streuwert 1.99, horizontal: 2.22, vertikal: 1.72

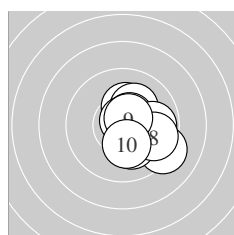
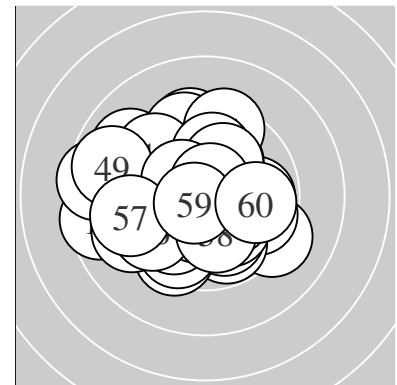

Serie 1:
 10.3 * 10.2 * 9.2 ↘ 10.6 * 9.8 →
 10.8 * 10.2 * 9.7 → 10.6 * 10.2 *
 beste Teiler 45.3 (6.) 84.6 (9.) 99.3 (4.)
 Trefferlage 1.31 mm rechts, 0.17 mm tief
 Streuwert 1.38, horizontal: 1.30, vertikal: 1.45

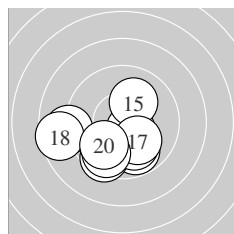

Serie 2:
 9.8 ↘ 10.6 * 9.5 ↙ 8.9 ← 10.1 ↗
 10.0 ↘ 10.1 ↘ 8.6 ← 9.7 ↙ 9.9 ↙
 beste Teiler 97.0 (12.) 210.7 (15.) 217.4 (17.)
 Trefferlage 1.03 mm links, 1.55 mm tief
 Streuwert 2.14, horizontal: 2.63, vertikal: 1.49

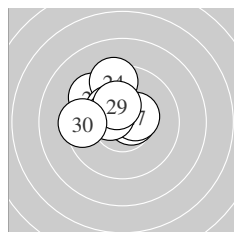

Serie 3:
 10.6 * 10.6 * 9.5 ↘ 9.4 ↑ 10.3 *
 10.3 * 10.4 * 10.4 * 10.3 * 9.5 ←
 beste Teiler 81.8 (21.) 93.0 (22.) 127.9 (28.)
 Trefferlage 0.95 mm links, 1.18 mm hoch
 Streuwert 1.31, horizontal: 1.47, vertikal: 1.13

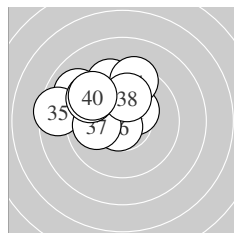

Serie 4:
 10.4 * 9.0 ↘ 9.5 ↑ 9.4 ↑ 8.5 ←
 10.7 * 10.0 ← 10.1 ↑ 9.5 ↘ 9.5 ↘
 beste Teiler 65.0 (36.) 149.8 (31.) 222.9 (38.)
 Trefferlage 1.72 mm links, 1.74 mm hoch
 Streuwert 1.96, horizontal: 2.36, vertikal: 1.47

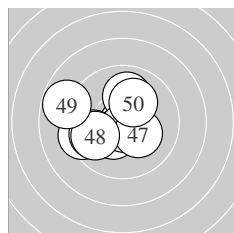

Serie 5:
 9.4 ← 10.9 * 10.0 ↑ 9.8 ← 10.4 *
 10.7 * 10.2 * 9.8 ← 8.8 ↘ 10.1 ↗
 beste Teiler 13.4 (42.) 57.4 (46.) 147.0 (45.)
 Trefferlage 1.19 mm links, 0.07 mm tief
 Streuwert 1.87, horizontal: 2.21, vertikal: 1.44

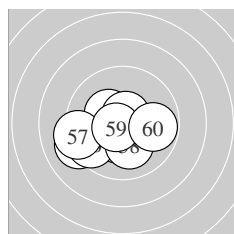

Serie 6:
 10.3 * 9.1 ← 10.7 * 10.7 * 10.3 *
 9.6 ← 9.2 ← 10.1 ↘ 10.7 * 9.8 →
 beste Teiler 71.0 (53.) 72.1 (59.) 73.9 (54.)
 Trefferlage 0.93 mm links, 0.82 mm tief
 Streuwert 1.74, horizontal: 2.22, vertikal: 1.05

LG 60 ZR – Wertung – **Männer**

StandNr: 121

Insam,, Fabian #70804040

StartNr: 19

13. Januar 2019 11:08

SG_Fügenberg

Unterschrift des Schützen

Meyton Elektronik

Ergebnis: **613.1** (582)
 Serien: 99.7 101.4 101.9 102.6 104.4 103.1
 Zähler: 42 18 0 0 0 0 0 0 0
 Innenzehner: 36
 weiteste: 393 (7), 380 (11), 357 (6)
 beste Teiler 13.0 (41.) 57.6 (37.) 58.6 (17.)
 Trefferlage 0.14 mm rechts, 0.67 mm hoch
 Streuwert 1.39, horizontal: 1.23, vertikal: 1.54

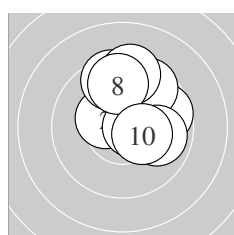
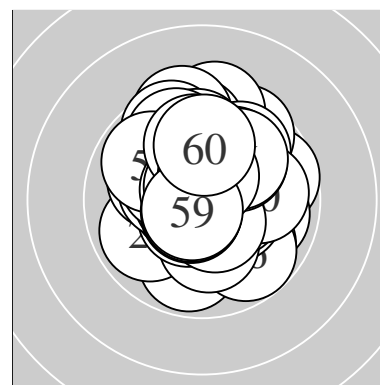

Serie 1:
 10.5 * 10.4 * 10.7 * 9.7 → 9.6 ↗
 9.5 ↑ 9.4 ↑ 9.7 ↑ 9.9 → 10.3 *
 beste Teiler 75.0 (3.) 111.6 (1.) 142.2 (2.)
 Trefferlage 0.74 mm rechts, 1.50 mm hoch
 Streuwert 1.58, horizontal: 1.44, vertikal: 1.71

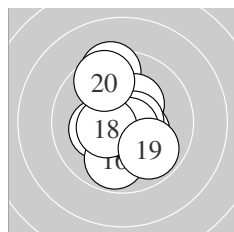

Serie 2:
 9.4 ↑ 10.2 * 10.3 * 10.4 * 10.6 *
 9.8 ↓ 10.7 * 10.5 * 9.9 ↘ 9.6 ↖
 beste Teiler 58.6 (17.) 80.1 (15.) 124.2 (18.)
 Trefferlage 0.05 mm links, 0.14 mm hoch
 Streuwert 1.68, horizontal: 1.25, vertikal: 2.02

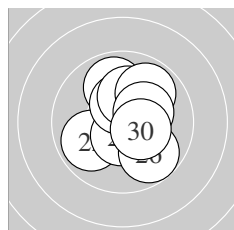

Serie 3:
 9.9 ↑ 9.9 ↙ 10.5 * 10.6 * 10.4 *
 9.8 ↘ 10.2 * 9.9 ↗ 10.3 * 10.4 *
 beste Teiler 98.8 (24.) 118.7 (23.) 135.4 (25.)
 Trefferlage 0.42 mm rechts, 0.25 mm hoch
 Streuwert 1.51, horizontal: 1.31, vertikal: 1.68

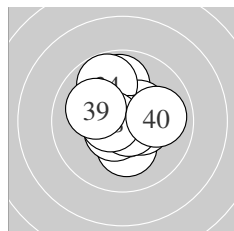

Serie 4:
 9.9 ↑ 10.4 * 10.2 * 9.8 ↖ 10.6 *
 10.4 * 10.7 * 10.6 * 10.1 ↗ 9.9 →
 beste Teiler 57.6 (37.) 88.0 (38.) 94.3 (35.)
 Trefferlage 0.09 mm rechts, 0.41 mm hoch
 Streuwert 1.38, horizontal: 1.33, vertikal: 1.43

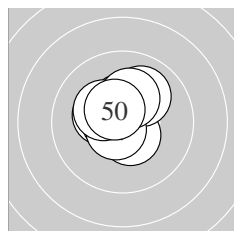

Serie 5:
 10.9 * 10.4 * 10.5 * 10.3 * 10.6 *
 10.0 ↗ 10.7 * 10.3 * 10.2 * 10.5 *
 beste Teiler 13.0 (41.) 73.6 (47.) 78.1 (45.)
 Trefferlage 0.25 mm links, 0.57 mm hoch
 Streuwert 0.92, horizontal: 0.89, vertikal: 0.96

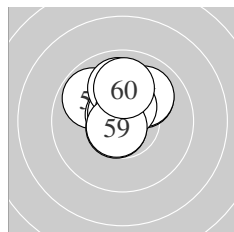

Serie 6:
 9.8 ↘ 10.0 ↗ 10.7 * 10.7 * 10.7 *
 10.0 ↗ 10.0 ↑ 10.5 * 10.7 * 10.0 ↑
 beste Teiler 61.5 (59.) 68.6 (53.) 68.9 (55.)
 Trefferlage 0.08 mm links, 1.12 mm hoch
 Streuwert 1.08, horizontal: 1.09, vertikal: 1.07

Meyton Elektronik

LG 60 ZR – Wertung – Juniorinnen

StandNr: 122

Leopold,, Magdalena #70802029

StartNr: 20

13. Januar 2019 10:36

SG_Aschau

Unterschrift des Schützen

Meyton Elektronik

Ergebnis: **411.4** (393)
 Serien: 103.0 101.4 103.6 103.4
 Zähler: 33 7 0 0 0 0 0 0 0 0
 Innenzehner: 25
 weiteste: 330 (11), 321 (38), 318 (19)
 beste Teiler 42.9 (26.) 50.0 (6.) 54.7 (36.)
 Trefferlage 0.01 mm links, 0.03 mm hoch
 Streuwert 1.33, horizontal: 1.38, vertikal: 1.28

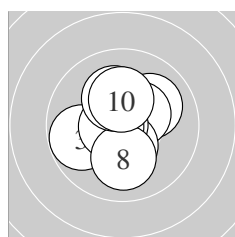
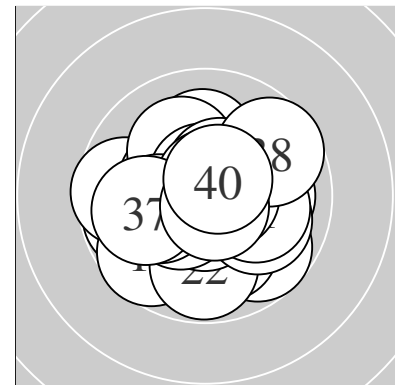

Serie 1:
 10.0 ↗ 10.5 * 9.8 ← 10.4 * 10.4 *
 10.8 * 10.6 * 10.1 ↓ 10.2 * 10.2 *
 beste Teiler 50.0 (6.) 79.5 (7.) 113.9 (2.)
 Trefferlage 0.24 mm links, 0.03 mm hoch
 Streuwert 1.31, horizontal: 1.24, vertikal: 1.38

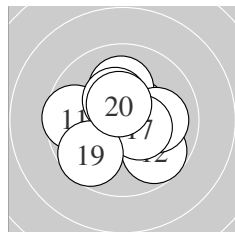

Serie 2:
 9.6 ← 9.7 ↘ 10.5 * 10.5 * 10.1 ↑
 10.0 → 10.4 * 10.4 * 9.7 ↙ 10.5 *
 beste Teiler 104.6 (13.) 106.3 (14.) 112.8 (20.)
 Trefferlage 0.00 mm , 0.15 mm hoch
 Streuwert 1.62, horizontal: 1.77, vertikal: 1.45

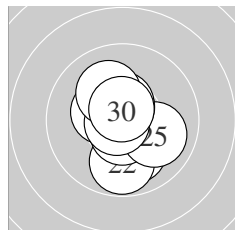

Serie 3:
 10.1 ↓ 9.8 ↓ 10.4 * 10.6 * 10.0 ↘
 10.8 * 10.6 * 10.5 * 10.1 ↖ 10.7 *
 beste Teiler 42.9 (26.) 75.4 (30.) 85.0 (24.)
 Trefferlage 0.00 mm , 0.18 mm tief
 Streuwert 1.26, horizontal: 0.96, vertikal: 1.50

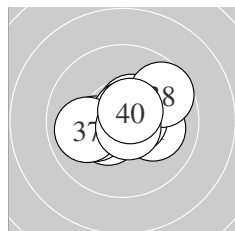

Serie 4:
 10.1 → 10.6 * 10.5 * 10.4 * 10.2 *
 10.7 * 9.9 ← 9.7 ↗ 10.7 * 10.6 *
 beste Teiler 54.7 (36.) 57.3 (39.) 83.0 (32.)
 Trefferlage 0.19 mm rechts, 0.11 mm hoch
 Streuwert 1.28, horizontal: 1.60, vertikal: 0.85

Unterschrift des Schützen

Meyton Elektronik

Ergebnis: **401.7** (382)
 Serien: 103.1 98.1 100.5 100.0
 Zähler: 24 14 2 0 0 0 0 0 0 0
 Innenzehner: 20
 weiteste: 553 (15), 516 (38), 459 (16)
 beste Teiler 43.2 (24.) 50.4 (31.) 56.8 (2.)
 Trefferlage 0.76 mm rechts, 0.08 mm tief
 Streuwert 1.80, horizontal: 1.95, vertikal: 1.64

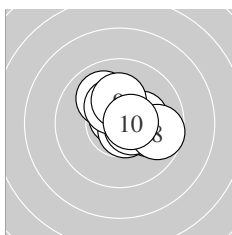
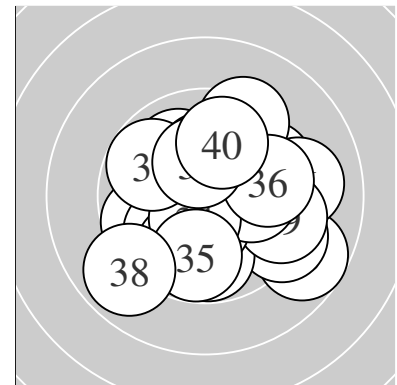

Serie 1:
 10.0 → 10.7 * 10.7 * 10.5 * 10.3 *
 10.0 ↘ 10.4 * 9.7 → 10.2 * 10.6 *
 beste Teiler 56.8 (2.) 73.8 (3.) 91.5 (10.)
 Trefferlage 0.72 mm rechts, 0.40 mm hoch
 Streuwert 1.21, horizontal: 1.38, vertikal: 1.01

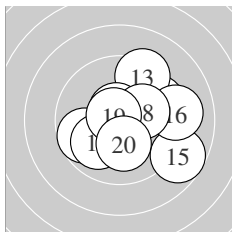

Serie 2:
 9.7 ← 9.6 → 9.3 ↑ 10.6 * 8.7 →
 9.1 → 10.0 ↙ 10.2 * 10.7 * 10.2 *
 beste Teiler 61.8 (19.) 84.4 (14.) 193.8 (20.)
 Trefferlage 1.10 mm rechts, 0.02 mm tief
 Streuwert 2.26, horizontal: 2.55, vertikal: 1.91

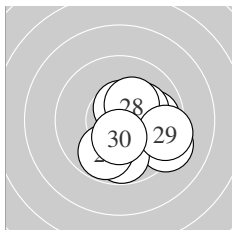

Serie 3:
 9.9 → 9.3 → 9.8 ↓ 10.8 * 10.2 *
 9.8 ↙ 10.6 * 10.3 * 9.4 → 10.4 *
 beste Teiler 43.2 (24.) 99.5 (27.) 138.0 (30.)
 Trefferlage 1.23 mm rechts, 0.68 mm tief
 Streuwert 1.60, horizontal: 1.68, vertikal: 1.51

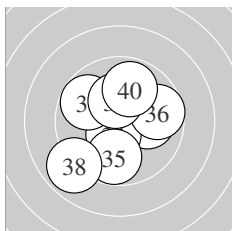

Serie 4:
 10.8 * 10.3 * 10.0 → 10.5 * 9.8 ↓
 9.7 → 9.8 ↘ 8.9 ↙ 10.3 * 9.9 ↑
 beste Teiler 50.4 (31.) 121.7 (34.) 151.3 (32.)
 Trefferlage 0.00 mm , 0.04 mm tief
 Streuwert 2.02, horizontal: 2.04, vertikal: 2.01

Unterschrift des Schützen

Meyton Elektronik

Ergebnis: **404.4** (391)
 Serien: 101.5 102.1 100.2 100.6
 Zähler: 31 9 0 0 0 0 0 0 0 0
 Innenzehner: 18
 weiteste: 499 (39), 444 (21), 410 (16)
 beste Teiler 37.2 (12.) 41.3 (2.) 52.0 (10.)
 Trefferlage 0.08 mm links, 0.06 mm hoch
 Streuwert 1.68, horizontal: 1.67, vertikal: 1.70

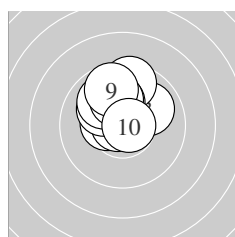
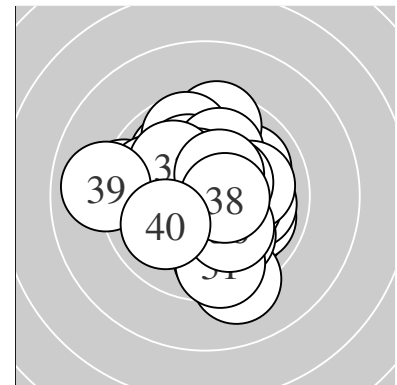

Serie 1:
 10.4 * 10.8 * 10.0 ↗ 9.5 ↑ 10.1 ↘
 10.2 * 10.0 ↘ 10.1 ↑ 9.7 ↑ 10.7 *
 beste Teiler 41.3 (2.) 52.0 (10.) 130.6 (1.)
 Trefferlage 0.35 mm links, 1.52 mm hoch
 Streuwert 1.18, horizontal: 1.15, vertikal: 1.21

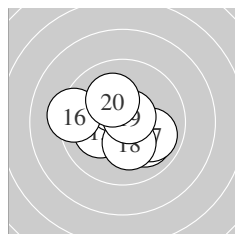

Serie 2:
 10.6 * 10.8 * 10.2 * 10.3 * 10.0 ↘
 9.3 ← 9.9 ↘ 10.2 * 10.7 * 10.1 ↘
 beste Teiler 37.2 (12.) 70.2 (19.) 85.6 (11.)
 Trefferlage 0.19 mm links, 0.19 mm tief
 Streuwert 1.56, horizontal: 1.83, vertikal: 1.22

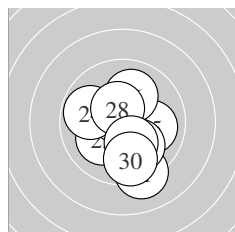

Serie 3:
 9.2 ↓ 10.1 ↙ 10.7 * 9.8 ← 10.0 →
 10.0 ↑ 10.0 ↓ 10.5 * 10.2 * 9.7 ↓
 beste Teiler 64.5 (23.) 121.4 (28.) 187.0 (29.)
 Trefferlage 0.20 mm rechts, 0.80 mm tief
 Streuwert 1.78, horizontal: 1.53, vertikal: 2.00

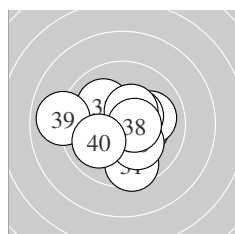

Serie 4:
 9.6 ↓ 10.3 * 10.1 ↘ 10.0 → 10.4 *
 10.2 * 10.4 * 10.6 * 9.0 ← 10.0 ↙
 beste Teiler 99.5 (38.) 129.2 (37.) 135.3 (35.)
 Trefferlage 0.01 mm rechts, 0.25 mm tief
 Streuwert 1.88, horizontal: 2.21, vertikal: 1.48

Unterschrift des Schützen

Meyton Elektronik

Ergebnis: **389.1** (371)
 Serien: 102.1 97.8 97.5 91.7
 Zähler: 16 19 5 0 0 0 0 0 0
 Innenzehner: 10
 weiteste: 723 (39), 639 (34), 601 (40)
 beste Teiler 43.8 (10.) 63.6 (33.) 94.5 (7.)
 Trefferlage 0.34 mm rechts, 0.32 mm hoch
 Streuwert 2.45, horizontal: 3.09, vertikal: 1.57

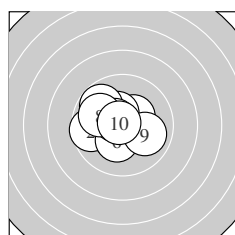
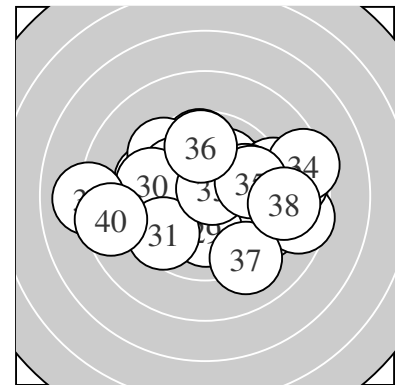

Serie 1:
 10.3 * 9.6 ← 10.4 * 10.4 * 9.8 ↖
 10.3 * 10.6 * 9.9 ↖ 10.0 → 10.8 *
 beste Teiler 43.8 (10.) 94.5 (7.) 136.5 (4.)
 Trefferlage 0.73 mm links, 0.16 mm hoch
 Streuwert 1.43, horizontal: 1.63, vertikal: 1.20

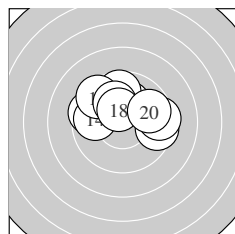

Serie 2:
 10.1 ↗ 9.5 ← 9.7 ↑ 9.8 ← 9.5 ↖
 10.1 ↘ 9.5 → 10.4 * 9.4 → 9.8 →
 beste Teiler 134.4 (18.) 207.4 (11.) 215.7 (16.)
 Trefferlage 0.03 mm rechts, 1.32 mm hoch
 Streuwert 2.03, horizontal: 2.63, vertikal: 1.15

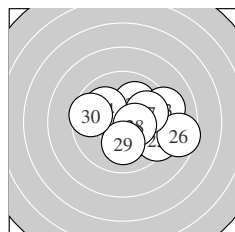

Serie 3:
 10.3 * 10.0 ↗ 9.2 → 10.0 ↖ 9.4 →
 8.6 → 9.9 → 10.4 * 10.1 ↓ 9.6 ←
 beste Teiler 129.5 (28.) 170.1 (21.) 215.0 (29.)
 Trefferlage 1.43 mm rechts, 0.06 mm tief
 Streuwert 2.22, horizontal: 2.74, vertikal: 1.52

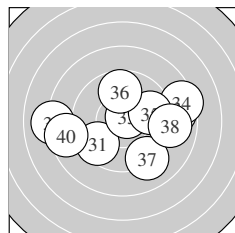

Serie 4:
 9.6 ↙ 8.8 → 10.7 * 8.4 → 9.8 →
 9.7 ↑ 9.1 ↘ 9.0 → 8.1 ← 8.5 ←
 beste Teiler 63.6 (33.) 297.6 (35.) 308.1 (36.)
 Trefferlage 0.63 mm rechts, 0.11 mm tief
 Streuwert 3.59, horizontal: 4.65, vertikal: 2.03

Unterschrift des Schützen

Meyton Elektronik

Ergebnis: **394.2** (375)
 Serien: 98.3 99.9 94.7 101.3
 Zähler: 20 16 3 1 0 0 0 0 0 0
 Innenzehner: 17
 weiteste: 826 (1), 631 (20), 558 (22)
 beste Teiler 45.5 (37.) 59.8 (9.) 81.3 (38.)
 Trefferlage 0.32 mm rechts, 0.06 mm hoch
 Streuwert 2.32, horizontal: 3.04, vertikal: 1.22

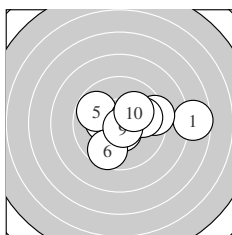
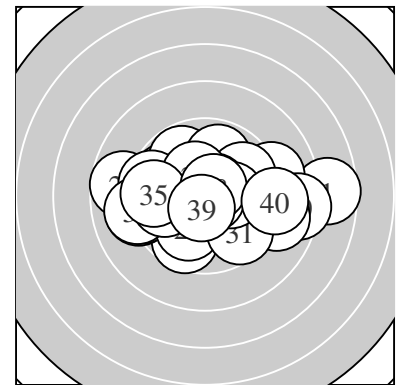

Serie 1:
 7.6 → 9.3 → 10.3 * 10.6 * 9.8 ↖
 9.6 ↙ 10.4 * 9.9 → 10.7 * 10.1 ↗
 beste Teiler 59.8 (9.) 98.9 (4.) 143.1 (7.)
 Trefferlage 1.27 mm rechts, 0.08 mm hoch
 Streuwert 2.42, horizontal: 3.16, vertikal: 1.29

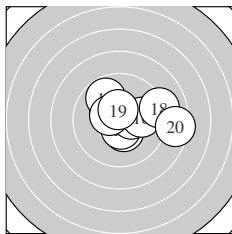

Serie 2:
 10.4 * 10.3 * 9.8 ↖ 10.5 * 10.4 *
 10.0 → 10.5 * 9.1 → 10.5 * 8.4 →
 beste Teiler 103.0 (14.) 119.3 (19.) 124.8 (17.)
 Trefferlage 1.11 mm rechts, 0.40 mm hoch
 Streuwert 2.01, horizontal: 2.58, vertikal: 1.18

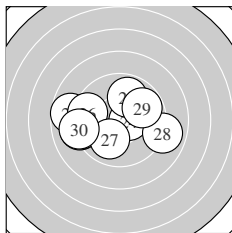

Serie 3:
 9.1 ← 8.7 ← 9.2 ← 10.5 * 9.9 ↑
 9.5 ← 10.0 ↙ 8.9 → 9.8 ↗ 9.1 ←
 beste Teiler 104.0 (24.) 239.7 (27.) 271.3 (25.)
 Trefferlage 1.42 mm links, 0.11 mm tief
 Streuwert 2.73, horizontal: 3.57, vertikal: 1.47

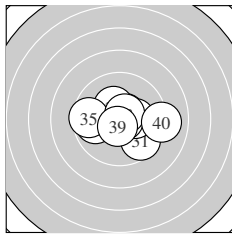

Serie 4:
 9.6 ↖ 10.6 * 10.3 * 9.8 ← 9.6 ←
 10.3 * 10.8 * 10.6 * 10.6 * 9.1 →
 beste Teiler 45.5 (37.) 81.3 (38.) 85.4 (39.)
 Trefferlage 0.33 mm rechts, 0.13 mm tief
 Streuwert 1.82, horizontal: 2.37, vertikal: 1.02

Unterschrift des Schützen

Meyton Elektronik

Ergebnis: **380.5** (365)
 Serien: 96.3 96.1 100.4 87.7
 Zähler: 11 24 4 1 0 0 0 0 0 0
 Innenzehner: 6
 weiteste: 993 (35), 718 (39), 707 (34)
 beste Teiler 16.6 (30.) 100.9 (20.) 114.4 (24.)
 Trefferlage 1.21 mm rechts, 0.07 mm hoch
 Streuwert 2.78, horizontal: 3.17, vertikal: 2.33

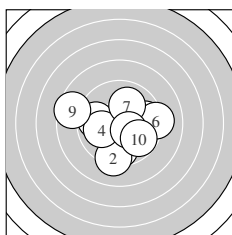
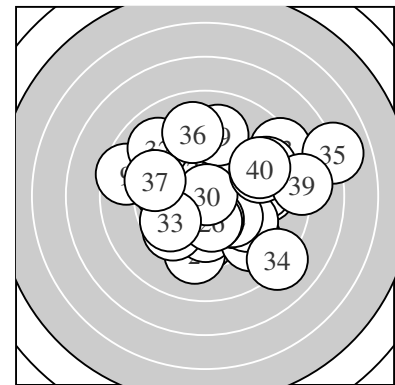

Serie 1:
 9.7 ↓ 9.2 ↓ 9.8 ← 10.0 ← 9.7 →
 9.2 → 10.0 ↑ 10.4 * 8.5 ← 9.8 ↘
 beste Teiler 139.2 (8.) 232.1 (4.) 235.6 (7.)
 Trefferlage 0.03 mm rechts, 0.59 mm tief
 Streuwert 2.60, horizontal: 3.07, vertikal: 2.03

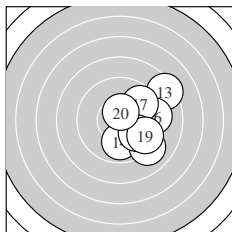

Serie 2:
 10.0 ↘ 9.8 → 8.3 ↗ 9.9 ↓ 9.1 ↘
 9.3 → 9.7 ↗ 9.9 ↘ 9.5 ↘ 10.6 *
 beste Teiler 100.9 (20.) 241.5 (11.) 261.8 (18.)
 Trefferlage 2.49 mm rechts, 0.44 mm tief
 Streuwert 1.99, horizontal: 1.75, vertikal: 2.21

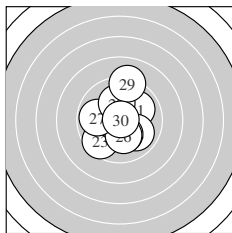

Serie 3:
 10.0 ↗ 9.9 ↘ 9.6 ↖ 10.5 * 10.2 *
 10.2 * 9.9 ← 10.1 ↑ 9.1 ↑ 10.9 *
 beste Teiler 16.6 (30.) 114.4 (24.) 182.4 (25.)
 Trefferlage 0.03 mm links, 0.08 mm hoch
 Streuwert 1.91, horizontal: 1.64, vertikal: 2.14

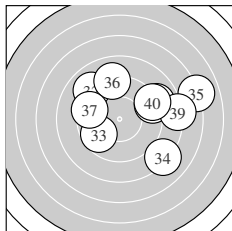

Serie 4:
 9.0 → 9.0 ↘ 9.7 ↖ 8.1 ↘ 7.0 →
 9.1 ↑ 9.4 ← 9.2 ↗ 8.1 → 9.1 →
 beste Teiler 314.4 (33.) 384.9 (37.) 440.7 (38.)
 Trefferlage 2.38 mm rechts, 1.27 mm hoch
 Streuwert 3.83, horizontal: 4.68, vertikal: 2.73

Unterschrift des Schützen

Meyton Elektronik

Ergebnis: **402.7** (384)
 Serien: 102.6 99.9 99.5 100.7
 Zähler: 26 12 2 0 0 0 0 0 0 0
 Innenzehner: 18
 weiteste: 675 (35), 505 (27), 398 (28)
 beste Teiler 47.0 (8.) 47.0 (39.) 64.1 (24.)
 Trefferlage 0.04 mm links, 0.54 mm hoch
 Streuwert 1.80, horizontal: 1.94, vertikal: 1.64

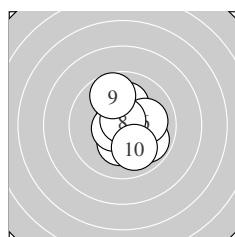
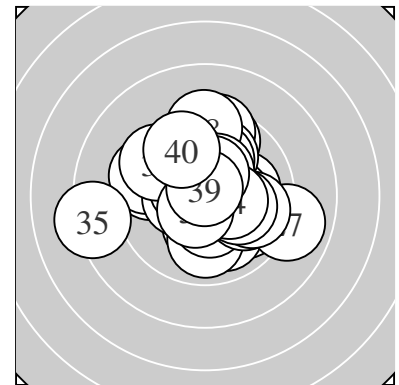

Serie 1:
 10.1 ↑ 10.5 * 9.9 ↘ 10.6 * 10.3 *
 10.1 → 10.6 * 10.8 * 9.7 ↑ 10.0 ↓
 beste Teiler 47.0 (8.) 87.0 (7.) 96.4 (4.)
 Trefferlage 0.36 mm rechts, 0.00 mm
 Streuwert 1.42, horizontal: 1.16, vertikal: 1.64

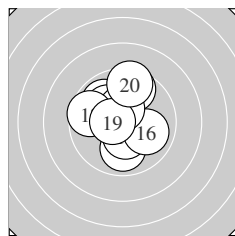

Serie 2:
 9.9 ↓ 9.6 ↑ 9.9 ↘ 10.4 * 10.1 ↘
 10.0 → 10.4 * 9.6 ← 10.6 * 9.4 ↑
 beste Teiler 99.1 (19.) 132.3 (17.) 140.8 (14.)
 Trefferlage 0.32 mm links, 0.76 mm hoch
 Streuwert 1.80, horizontal: 1.57, vertikal: 2.00

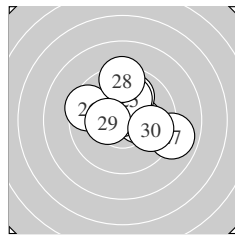

Serie 3:
 10.3 * 10.0 ↑ 10.4 * 10.7 * 10.1 ↑
 9.5 ↙ 8.9 → 9.4 ↑ 10.4 * 9.8 →
 beste Teiler 64.1 (24.) 141.1 (23.) 145.5 (29.)
 Trefferlage 0.58 mm rechts, 0.90 mm hoch
 Streuwert 1.96, horizontal: 2.23, vertikal: 1.64

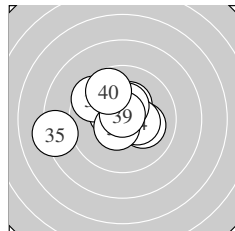

Serie 4:
 10.5 * 10.1 → 10.3 * 10.4 * 8.3 ←
 9.6 ↙ 10.4 * 10.6 * 10.8 * 9.7 ↘
 beste Teiler 47.0 (39.) 98.2 (38.) 114.9 (31.)
 Trefferlage 0.80 mm links, 0.52 mm hoch
 Streuwert 1.98, horizontal: 2.47, vertikal: 1.32

Unterschrift des Schützen

Meyton Elektronik

Ergebnis: **394.3** (375)
 Serien: 97.2 100.3 99.4 97.4
 Zähler: 18 19 3 0 0 0 0 0 0 0
 Innenzehner: 13
 weiteste: 580 (32), 556 (31), 503 (7)
 beste Teiler 60.9 (12.) 67.6 (24.) 97.0 (20.)
 Trefferlage 0.87 mm rechts, 0.04 mm hoch
 Streuwert 2.10, horizontal: 2.37, vertikal: 1.80

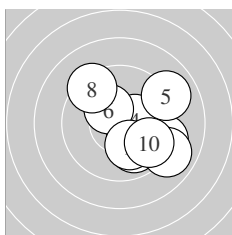
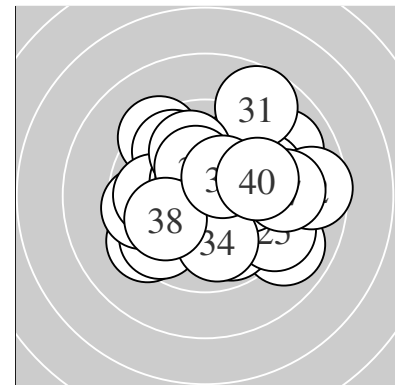

Serie 1:
 10.3 * 9.3 → 9.9 ↘ 10.4 * 9.0 ↗
 10.3 * 8.9 ↘ 9.3 ↖ 10.1 ↘ 9.7 ↘
 beste Teiler 142.8 (4.) 158.5 (1.) 161.8 (6.)
 Trefferlage 1.63 mm rechts, 0.39 mm tief
 Streuwert 2.17, horizontal: 2.24, vertikal: 2.08

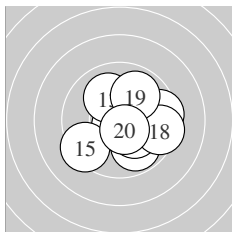

Serie 2:
 10.6 * 10.7 * 10.0 ↖ 9.5 → 9.4 ↗
 9.9 ↘ 10.2 * 9.5 → 9.9 ↗ 10.6 *
 beste Teiler 60.9 (12.) 97.0 (20.) 98.5 (11.)
 Trefferlage 0.75 mm rechts, 0.25 mm tief
 Streuwert 1.86, horizontal: 2.04, vertikal: 1.65

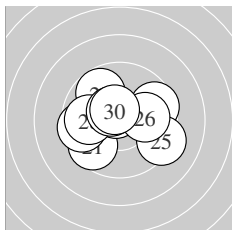

Serie 3:
 9.6 ↖ 9.6 → 9.8 ↖ 10.7 * 9.3 ↘
 10.0 → 9.6 ← 9.8 ← 10.5 * 10.5 *
 beste Teiler 67.6 (24.) 104.2 (30.) 110.3 (29.)
 Trefferlage 0.26 mm links, 0.15 mm hoch
 Streuwert 2.06, horizontal: 2.54, vertikal: 1.42

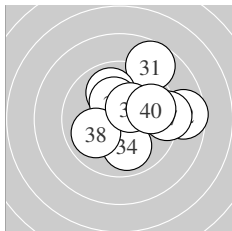

Serie 4:
 8.7 ↗ 8.6 → 10.5 * 10.0 ↘ 9.9 ↖
 10.3 * 9.2 → 10.0 ↖ 10.4 * 9.8 →
 beste Teiler 116.1 (33.) 141.5 (39.) 165.0 (36.)
 Trefferlage 1.37 mm rechts, 0.66 mm hoch
 Streuwert 2.29, horizontal: 2.50, vertikal: 2.05

Unterschrift des Schützen

Meyton Elektronik

Ergebnis: **407.2** (388)
 Serien: 102.1 102.3 101.8 101.0
 Zähler: 28 12 0 0 0 0 0 0 0 0
 Innenzehner: 22
 weiteste: 432 (35), 427 (6), 360 (25)
 beste Teiler 46.4 (28.) 51.4 (20.) 55.9 (4.)
 Trefferlage 0.05 mm links, 0.41 mm hoch
 Streuwert 1.56, horizontal: 1.68, vertikal: 1.43

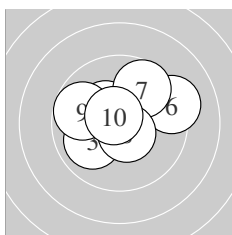
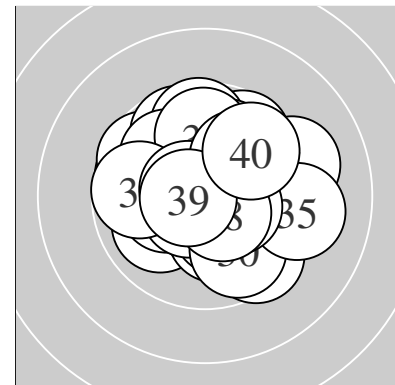

Serie 1:
 10.4 * 10.7 * 10.0 ↙ 10.7 * 10.4 *
 9.2 → 9.7 ↗ 10.6 * 9.7 ← 10.7 *
 beste Teiler 55.9 (4.) 58.0 (2.) 73.4 (10.)
 Trefferlage 0.18 mm links, 0.42 mm hoch
 Streuwert 1.63, horizontal: 1.97, vertikal: 1.18

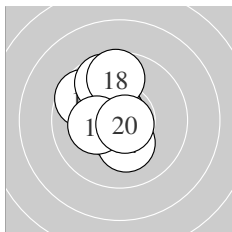

Serie 2:
 10.2 * 10.6 * 10.6 * 10.2 * 9.7 ↘
 9.7 ↖ 10.7 * 9.7 ↑ 10.2 * 10.7 *
 beste Teiler 51.4 (20.) 59.6 (17.) 76.8 (12.)
 Trefferlage 0.78 mm links, 0.68 mm hoch
 Streuwert 1.34, horizontal: 1.03, vertikal: 1.59

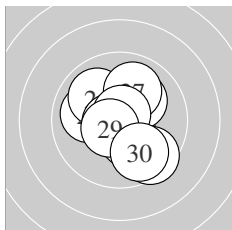

Serie 3:
 10.3 * 10.0 ← 10.1 ↗ 10.0 ↘ 9.5 ↘
 10.7 * 10.0 ↗ 10.8 * 10.6 * 9.8 ↘
 beste Teiler 46.4 (28.) 68.6 (26.) 95.9 (29.)
 Trefferlage 0.17 mm rechts, 0.09 mm tief
 Streuwert 1.62, horizontal: 1.52, vertikal: 1.72

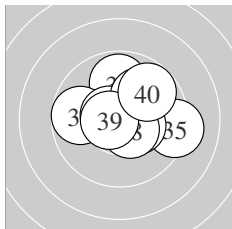

Serie 4:
 10.4 * 9.8 ↑ 9.7 ← 10.6 * 9.2 →
 10.0 ↗ 10.4 * 10.5 * 10.6 * 9.8 ↗
 beste Teiler 78.5 (39.) 85.4 (34.) 113.1 (38.)
 Trefferlage 0.57 mm rechts, 0.63 mm hoch
 Streuwert 1.65, horizontal: 1.96, vertikal: 1.25

Unterschrift des Schützen

Meyton Elektronik

Ergebnis: **398.4** (380)
 Serien: 98.3 99.5 101.5 99.1
 Zähler: 22 16 2 0 0 0 0 0 0 0
 Innenzehner: 18
 weiteste: 564 (30), 503 (37), 492 (1)
 beste Teiler 37.5 (25.) 45.2 (12.) 70.0 (29.)
 Trefferlage 0.55 mm rechts, 1.04 mm tief
 Streuwert 1.88, horizontal: 2.09, vertikal: 1.64

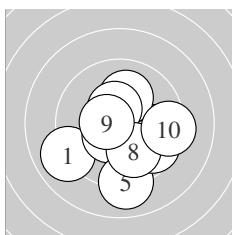
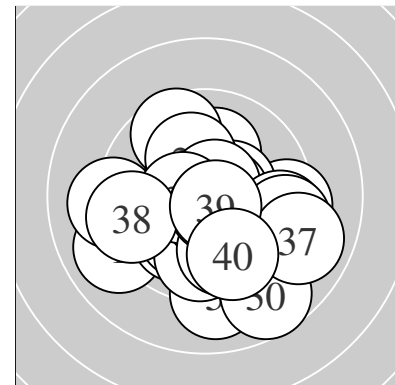

Serie 1:
 9.0 ↙ 10.4 * 9.9 → 10.1 ↑ 9.0 ↓
 9.6 ↘ 10.5 * 10.0 ↘ 10.5 * 9.3 →
 beste Teiler 106.4 (9.) 124.9 (7.) 130.7 (2.)
 Trefferlage 0.49 mm rechts, 1.01 mm tief
 Streuwert 2.16, horizontal: 2.34, vertikal: 1.96

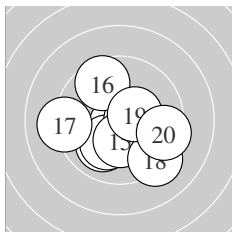

Serie 2:
 10.0 ↗ 10.8 * 10.1 ↗ 10.6 * 10.3 *
 9.6 ↘ 9.1 ← 9.2 ↘ 10.4 * 9.4 →
 beste Teiler 45.2 (12.) 95.0 (14.) 133.8 (19.)
 Trefferlage 0.02 mm rechts, 0.68 mm tief
 Streuwert 2.05, horizontal: 2.34, vertikal: 1.70

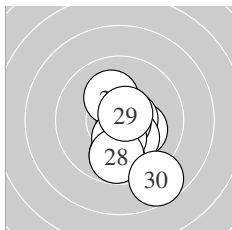

Serie 3:
 10.2 * 10.6 * 10.3 * 9.8 ↓ 10.8 *
 10.2 * 10.4 * 9.8 ↓ 10.7 * 8.7 ↘
 beste Teiler 37.5 (25.) 70.0 (29.) 90.3 (22.)
 Trefferlage 0.61 mm rechts, 1.19 mm tief
 Streuwert 1.57, horizontal: 1.09, vertikal: 1.94

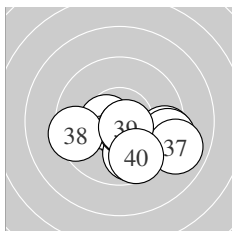

Serie 4:
 10.6 * 9.4 → 9.3 → 10.5 * 9.8 ↓
 10.7 * 8.9 → 9.5 ← 10.7 * 9.7 ↘
 beste Teiler 72.1 (39.) 74.5 (36.) 99.6 (31.)
 Trefferlage 1.10 mm rechts, 1.29 mm tief
 Streuwert 1.87, horizontal: 2.48, vertikal: 0.93

Unterschrift des Schützen

Ergebnis: **369.4** (350)
 Serien: 94.3 90.9 87.9 96.3
 Zähler: 8 18 10 4 0 0 0 0 0 0
 Innenzehner: 5
 weiteste: 920 (18), 894 (8), 885 (14)
 beste Teiler 70.1 (7.) 103.6 (1.) 153.3 (39.)
 Trefferlage 0.04 mm links, 0.05 mm hoch
 Streuwert 3.45, horizontal: 3.92, vertikal: 2.90

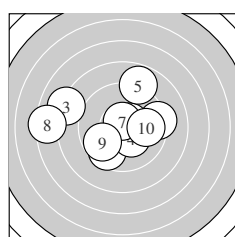
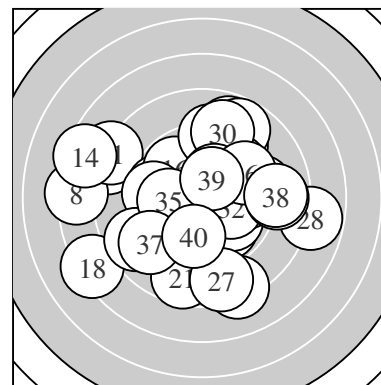

Serie 1:
 10.5 * 9.6 ↙ 8.1 ↖ 10.3 * 8.8 ↗
 9.3 → 10.7 * 7.4 ← 9.8 ↘ 9.8 →
 beste Teiler 70.1 (7.) 103.6 (1.) 165.0 (4.)
 Trefferlage 0.92 mm links, 0.40 mm hoch
 Streuwert 3.33, horizontal: 4.16, vertikal: 2.21

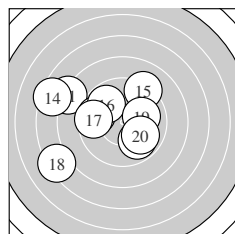

Serie 2:
 8.1 ↖ 9.9 ↘ 9.7 ↖ 7.4 ↖ 9.2 ↗
 9.8 ↘ 9.6 ← 7.3 ↗ 10.0 → 9.9 ↘
 beste Teiler 233.4 (19.) 260.6 (20.) 274.5 (12.)
 Trefferlage 2.26 mm links, 0.53 mm hoch
 Streuwert 3.59, horizontal: 4.28, vertikal: 2.72

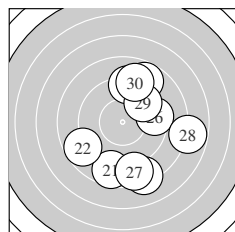

Serie 3:
 8.6 ↓ 8.7 ↘ 8.2 ↓ 9.2 ↑ 8.8 ↗
 9.4 → 8.6 ↓ 7.8 → 9.6 ↗ 9.0 ↑
 beste Teiler 332.4 (29.) 385.8 (26.) 445.6 (24.)
 Trefferlage 1.63 mm rechts, 0.52 mm tief
 Streuwert 3.94, horizontal: 3.24, vertikal: 4.53

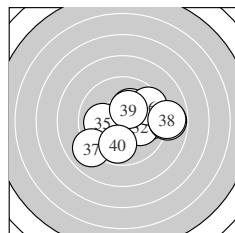

Serie 4:
 9.7 → 10.1 → 10.2 * 8.8 → 10.0 ←
 9.5 ↗ 9.0 ↗ 8.9 → 10.3 * 9.8 ↓
 beste Teiler 153.3 (39.) 183.0 (33.) 217.2 (32.)
 Trefferlage 1.36 mm rechts, 0.17 mm tief
 Streuwert 2.43, horizontal: 3.00, vertikal: 1.68

Unterschrift des Schützen

Meyton Elektronik

Ergebnis: **388.2** (372)
 Serien: 99.1 94.8 96.8 97.5
 Zähler: 18 16 6 0 0 0 0 0 0 0
 Innenzehner: 11
 weiteste: 674 (14), 649 (29), 630 (31)
 beste Teiler 80.6 (6.) 102.8 (8.) 112.7 (26.)
 Trefferlage 0.41 mm links, 0.64 mm hoch
 Streuwert 2.45, horizontal: 2.68, vertikal: 2.18

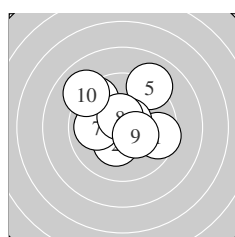
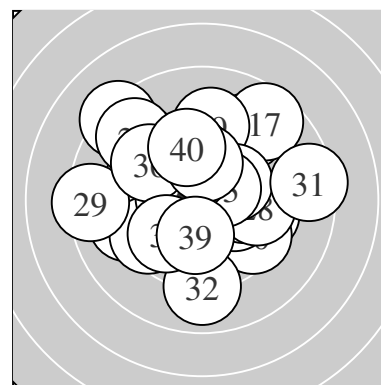

Serie 1:
 9.5 → 10.3 * 9.5 ↘ 10.2 * 9.1 ↗
 10.6 * 10.0 ← 10.5 * 10.4 * 9.0 ↘
 beste Teiler 80.6 (6.) 102.8 (8.) 146.1 (9.)
 Trefferlage 0.34 mm links, 0.91 mm hoch
 Streuwert 2.09, horizontal: 2.32, vertikal: 1.84

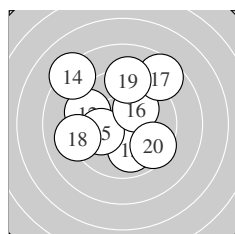

Serie 2:
 10.4 * 9.5 ↖ 9.9 ↓ 8.3 ↘ 10.1 ←
 10.2 * 8.6 ↗ 9.1 ← 9.2 ↑ 9.5 ↘
 beste Teiler 149.5 (11.) 195.6 (16.) 220.4 (15.)
 Trefferlage 0.45 mm links, 0.84 mm hoch
 Streuwert 2.91, horizontal: 3.01, vertikal: 2.80

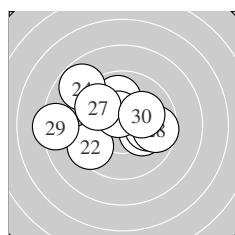

Serie 3:
 10.1 → 9.5 ↙ 9.9 ↑ 8.8 ↘ 10.0 →
 10.5 * 9.8 ↘ 9.7 → 8.4 ← 10.1 ↗
 beste Teiler 112.7 (26.) 202.6 (21.) 210.7 (30.)
 Trefferlage 0.74 mm links, 0.64 mm hoch
 Streuwert 2.55, horizontal: 3.18, vertikal: 1.70

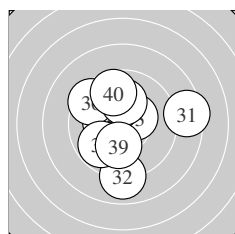

Serie 4:
 8.4 → 8.9 ↓ 10.4 * 10.3 * 10.3 *
 9.5 ↘ 10.1 ↑ 9.8 ↙ 10.1 ↓ 9.7 ↑
 beste Teiler 135.2 (33.) 162.6 (35.) 168.2 (34.)
 Trefferlage 0.12 mm links, 0.16 mm hoch
 Streuwert 2.51, horizontal: 2.53, vertikal: 2.48

Unterschrift des Schützen

Meyton Elektronik

Ergebnis: **383.4** (368)

Serien: 93.7 98.2 95.2 96.3

Zähler: 20 9 10 1 0 0 0 0 0 0

Innenzehner: 14

weiteste: 779 (3), 742 (26), 680 (40)

beste Teiler 47.1 (12.) 106.7 (33.) 110.1 (25.)

Trefferlage 0.55 mm rechts, 0.11 mm hoch

Streuwert 2.82, horizontal: 3.44, vertikal: 2.02

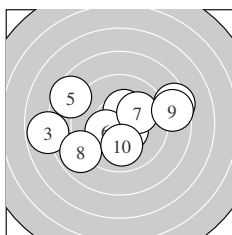
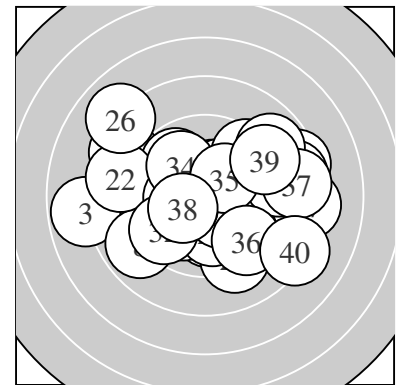

Serie 1:

8.5 →	10.4 *	7.8 ←	10.5 *	8.6 ↖
10.3 *	10.1 ↗	8.9 ↙	8.6 →	10.0 ↓

beste Teiler 114.7 (4.) 146.7 (2.) 169.5 (6.)

Trefferlage 0.36 mm links, 0.07 mm hoch

Streuwert 3.44, horizontal: 4.45, vertikal: 1.96

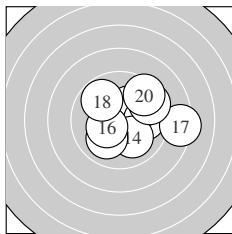

Serie 2:

10.2 *	10.8 *	9.9 →	10.0 ↘	10.0 ↙
10.3 *	8.3 →	9.8 ↖	9.5 ↗	9.4 ↗

beste Teiler 47.1 (12.) 155.2 (16.) 176.7 (11.)

Trefferlage 1.33 mm rechts, 0.30 mm hoch

Streuwert 2.17, horizontal: 2.59, vertikal: 1.64

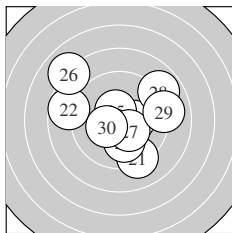

Serie 3:

9.2 ↘	8.7 ←	10.0 ↓	10.3 *	10.5 *
8.0 ↖	10.3 *	8.9 ↗	9.0 →	10.3 *

beste Teiler 110.1 (25.) 151.3 (24.) 152.2 (27.)

Trefferlage 0.11 mm rechts, 0.29 mm hoch

Streuwert 3.07, horizontal: 3.49, vertikal: 2.59

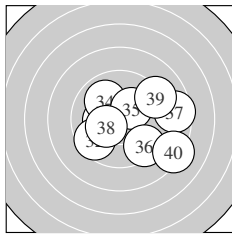

Serie 4:

10.3 *	9.6 ↙	10.5 *	10.0 ↖	10.3 *
9.4 ↘	8.6 →	10.3 *	9.1 ↗	8.2 ↘

beste Teiler 106.7 (33.) 164.2 (38.) 171.3 (35.)

Trefferlage 1.15 mm rechts, 0.23 mm tief

Streuwert 2.71, horizontal: 3.24, vertikal: 2.05

Unterschrift des Schützen

Meyton Elektronik

Ergebnis: **370.8** (351)
 Serien: 94.5 89.4 87.4 99.5
 Zähler: 11 15 10 3 0 1 0 0 0 0
 Innenzehner: 11
 weiteste: 1283 (30), 895 (4), 852 (22)
 beste Teiler 12.0 (9.) 36.0 (35.) 74.3 (5.)
 Trefferlage 1.56 mm rechts, 0.39 mm tief
 Streuwert 3.38, horizontal: 3.96, vertikal: 2.68

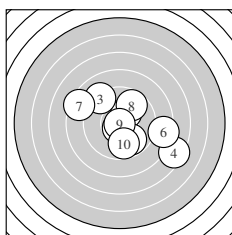
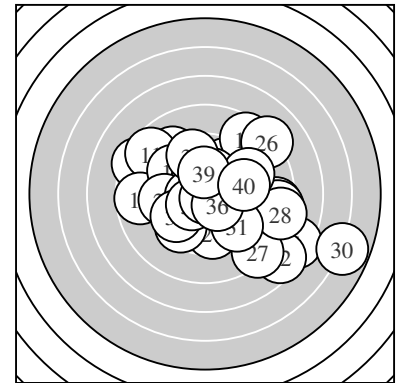

Serie 1:
 10.3 * 9.8 ↘ 9.1 ↖ 7.4 ↗ 10.7 *
 8.4 → 8.4 ↙ 9.7 ↗ 10.9 * 9.8 ↓
 beste Teiler 12.0 (9.) 74.3 (5.) 170.2 (1.)
 Trefferlage 1.02 mm rechts, 0.13 mm tief
 Streuwert 3.37, horizontal: 3.97, vertikal: 2.64

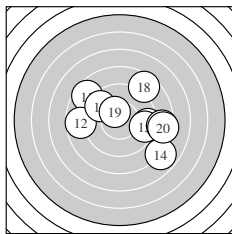

Serie 2:
 8.6 ↖ 8.7 ← 9.3 → 7.9 ↘ 9.4 →
 8.5 → 9.6 ↖ 8.6 ↗ 10.4 * 8.4 →
 beste Teiler 138.0 (19.) 343.6 (17.) 376.9 (15.)
 Trefferlage 1.58 mm rechts, 0.28 mm hoch
 Streuwert 3.80, horizontal: 4.62, vertikal: 2.74

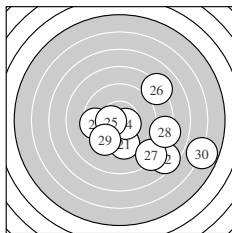

Serie 3:
 9.6 ↓ 7.5 ↘ 9.5 ← 10.5 * 10.4 *
 8.2 ↗ 8.2 ↘ 8.2 → 9.5 ↙ 5.8 →
 beste Teiler 102.3 (24.) 126.1 (25.) 345.1 (21.)
 Trefferlage 2.95 mm rechts, 1.99 mm tief
 Streuwert 4.02, horizontal: 4.82, vertikal: 3.01

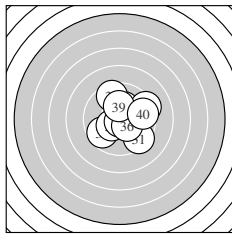

Serie 4:
 9.4 ↘ 9.7 ↙ 10.4 * 10.2 * 10.8 *
 10.4 * 9.5 ↖ 9.3 ↗ 10.2 * 9.6 →
 beste Teiler 36.0 (35.) 145.1 (36.) 146.6 (33.)
 Trefferlage 0.67 mm rechts, 0.25 mm hoch
 Streuwert 2.01, horizontal: 2.08, vertikal: 1.94

Unterschrift des Schützen

Meyton Elektronik

Ergebnis: **395.1** (376)
 Serien: 97.7 100.2 100.1 97.1
 Zähler: 20 17 2 1 0 0 0 0 0 0
 Innenzehner: 14
 weiteste: 786 (34), 572 (37), 533 (33)
 beste Teiler 21.2 (36.) 61.3 (3.) 90.8 (38.)
 Trefferlage 0.33 mm links, 0.13 mm hoch
 Streuwert 2.17, horizontal: 2.72, vertikal: 1.44

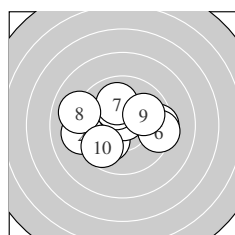
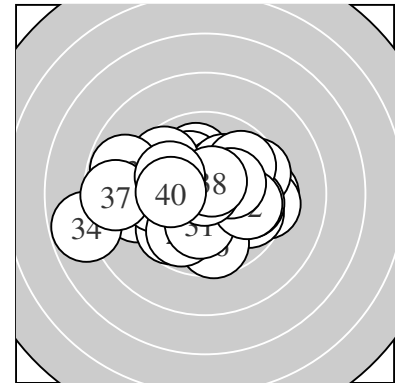

Serie 1:
 10.1 ↙ 9.2 ← 10.7 * 9.5 → 10.2 *
 9.4 → 10.0 ↑ 9.0 ← 9.9 ↗ 9.7 ↘
 beste Teiler 61.3 (3.) 188.3 (5.) 218.0 (1.)
 Trefferlage 0.38 mm links, 0.18 mm hoch
 Streuwert 2.36, horizontal: 2.98, vertikal: 1.50

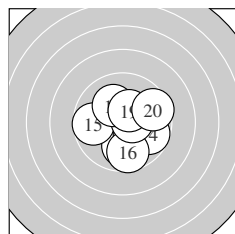

Serie 2:
 9.9 ↓ 10.2 * 10.4 * 9.7 ↘ 9.7 ←
 9.7 ↓ 10.5 * 10.1 ↘ 10.4 * 9.6 →
 beste Teiler 102.1 (17.) 140.6 (19.) 150.0 (13.)
 Trefferlage 0.66 mm rechts, 0.30 mm tief
 Streuwert 1.75, horizontal: 1.81, vertikal: 1.68

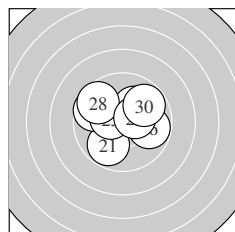

Serie 3:
 9.8 ↙ 9.6 ← 10.0 ↗ 10.5 * 10.4 *
 9.8 → 10.2 * 9.6 ↘ 10.4 * 9.8 ↗
 beste Teiler 122.7 (24.) 132.8 (25.) 139.5 (29.)
 Trefferlage 0.21 mm rechts, 0.69 mm hoch
 Streuwert 1.77, horizontal: 2.12, vertikal: 1.34

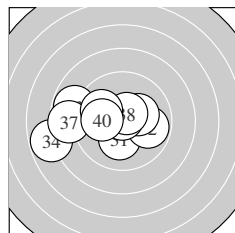

Serie 4:
 10.2 * 9.8 → 8.8 ← 7.8 ← 10.2 *
 10.9 * 8.7 ← 10.6 * 10.0 ↘ 10.1 ←
 beste Teiler 21.2 (36.) 90.8 (38.) 178.4 (35.)
 Trefferlage 1.84 mm links, 0.02 mm tief
 Streuwert 2.53, horizontal: 3.37, vertikal: 1.21

Unterschrift des Schützen

Ergebnis: **148.3** (138)
 Serien: 80.8 67.5
 Zähler: 3 3 2 1 6 3 1 1 0 0
 Innenzehner: 3
 weiteste: 1812 (20), 1581 (19), 1496 (5)
 beste Teiler 38.0 (14.) 93.4 (7.) 127.4 (9.)
 Trefferlage 2.58 mm rechts, 4.08 mm tief
 Streuwert 6.54, horizontal: 7.62, vertikal: 5.23

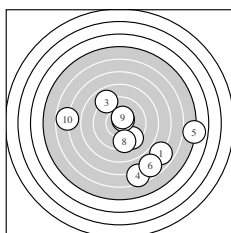
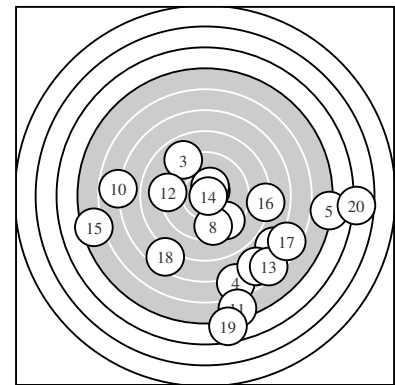

Serie 1:
 6.9 ↘ 9.4 ↘ 8.9 ↖ 6.5 ↓ 5.0 →
 6.8 ↘ 10.6 * 9.5 ↓ 10.4 * 6.8 ←
 beste Teiler 93.4 (7.) 127.4 (9.) 372.8 (8.)
 Trefferlage 2.46 mm rechts, 2.61 mm tief
 Streuwert 5.74, horizontal: 6.68, vertikal: 4.62

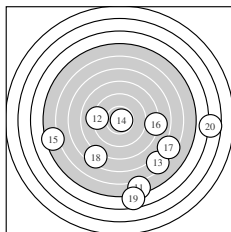

Serie 2:
 5.4 ↓ 9.2 ← 6.4 ↘ 10.8 * 5.4 ←
 8.0 → 6.5 ↘ 7.5 ↙ 4.6 ↓ 3.7 →
 beste Teiler 38.0 (14.) 448.9 (12.) 728.0 (16.)
 Trefferlage 2.71 mm rechts, 5.54 mm tief
 Streuwert 7.40, horizontal: 8.82, vertikal: 5.63

Unterschrift des Schützen

Ergebnis: **186.8** (177)
 Serien: 96.2 90.6
 Zähler: 6 6 7 1 0 0 0 0 0 0
 Innenzehner: 6
 weiteste: 966 (12), 695 (1), 694 (19)
 beste Teiler 151.3 (10.) 158.5 (16.) 164.9 (3.)
 Trefferlage 0.13 mm links, 0.20 mm hoch
 Streuwert 3.32, horizontal: 4.13, vertikal: 2.21

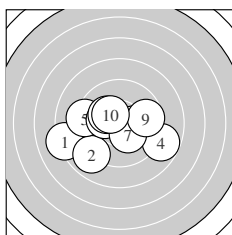
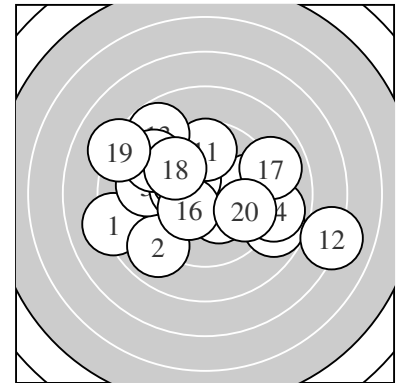

Serie 1:
 8.2 ← 8.9 ↙ 10.3 * 8.8 ↘ 9.3 ←
 10.2 * 10.3 * 10.2 * 9.7 → 10.3 *
 beste Teiler 151.3 (10.) 164.9 (3.) 165.6 (7.)
 Trefferlage 0.78 mm links, 0.60 mm tief
 Streuwert 2.75, horizontal: 3.52, vertikal: 1.67

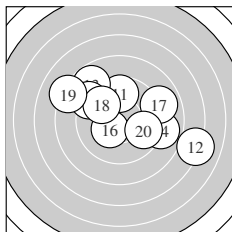

Serie 2:
 9.7 ↑ 7.1 → 8.8 ↘ 8.9 → 9.2 ↘
 10.3 * 8.9 → 9.8 ↘ 8.2 ↘ 9.7 →
 beste Teiler 158.5 (16.) 282.9 (18.) 311.2 (20.)
 Trefferlage 0.51 mm rechts, 1.00 mm hoch
 Streuwert 3.80, horizontal: 4.77, vertikal: 2.47

Unterschrift des Schützen

Ergebnis: **202.8** (192)
 Serien: 101.1 101.7
 Zähler: 12 8 0 0 0 0 0 0 0 0
 Innenzehner: 12
 weiteste: 500 (18), 441 (11), 378 (6)
 beste Teiler 66.5 (19.) 84.1 (16.) 92.8 (17.)
 Trefferlage 0.13 mm links, 0.79 mm hoch
 Streuwert 1.62, horizontal: 1.53, vertikal: 1.71

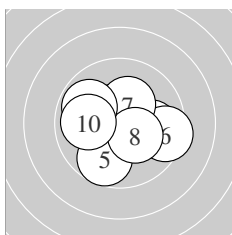
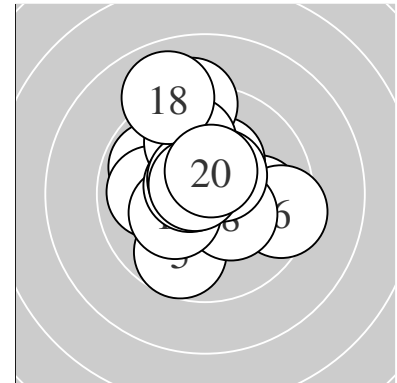

Serie 1:
 10.6 * 10.6 * 10.6 * 9.9 → 9.7 ↓
 9.4 → 10.3 * 10.3 * 9.8 ↖ 9.9 ←
 beste Teiler 93.0 (1.) 100.3 (3.) 100.7 (2.)
 Trefferlage 0.27 mm rechts, 0.03 mm hoch
 Streuwert 1.70, horizontal: 2.00, vertikal: 1.32

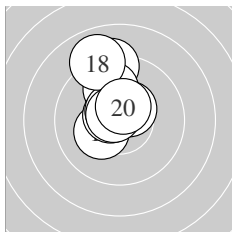

Serie 2:
 9.2 ↑ 10.4 * 9.9 ↑ 10.3 * 10.5 *
 10.6 * 10.6 * 9.0 ↑ 10.7 * 10.5 *
 beste Teiler 66.5 (19.) 84.1 (16.) 92.8 (17.)
 Trefferlage 0.53 mm links, 1.55 mm hoch
 Streuwert 1.37, horizontal: 0.76, vertikal: 1.78

Unterschrift des Schützen

Ergebnis: **180.8** (170)
 Serien: 94.4 86.4
 Zähler: 4 7 6 2 0 1 0 0 0 0
 Innenzehner: 2
 weiteste: 1256 (15), 899 (20), 801 (16)
 beste Teiler 57.3 (10.) 72.8 (17.) 223.7 (2.)
 Trefferlage 2.65 mm links, 1.51 mm tief
 Streuwert 3.34, horizontal: 3.85, vertikal: 2.74

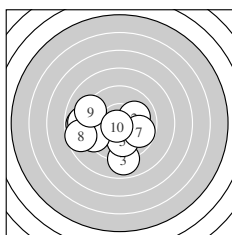
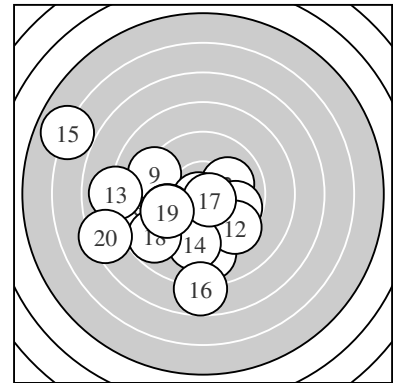

Serie 1:
 8.8 ← 10.1 → 8.9 ↓ 8.9 ← 10.0 ↓
 9.3 ↙ 9.8 ↘ 8.7 ← 9.2 ↖ 10.7 *
 beste Teiler 57.3 (10.) 223.7 (2.) 248.9 (5.)
 Trefferlage 1.81 mm links, 1.00 mm tief
 Streuwert 2.64, horizontal: 3.21, vertikal: 1.90

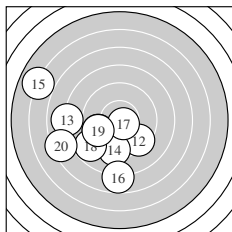

Serie 2:
 9.6 ↙ 9.4 ↘ 8.0 ← 9.3 ↓ 5.9 ↖
 7.7 ↓ 10.7 * 8.8 ↙ 9.6 ← 7.4 ←
 beste Teiler 72.8 (17.) 332.8 (11.) 336.3 (19.)
 Trefferlage 3.49 mm links, 2.02 mm tief
 Streuwert 3.94, horizontal: 4.40, vertikal: 3.42

Unterschrift des Schützen

Ergebnis: **198.7** (189)
 Serien: 98.4 100.3
 Zähler: 10 9 1 0 0 0 0 0 0 0
 Innenzehner: 9
 weiteste: 544 (6), 464 (2), 443 (20)
 beste Teiler 33.3 (10.) 35.4 (1.) 70.4 (11.)
 Trefferlage 1.53 mm rechts, 0.29 mm hoch
 Streuwert 1.85, horizontal: 2.22, vertikal: 1.39

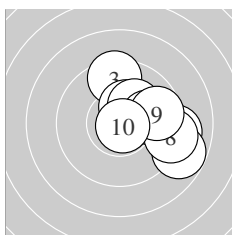
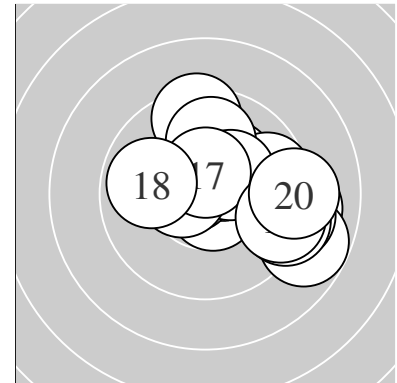

Serie 1:
 10.8 * 9.1 → 9.4 ↑ 10.4 * 10.2 *
 8.8 ↘ 10.0 → 9.2 → 9.7 → 10.8 *
 beste Teiler 33.3 (10.) 35.4 (1.) 144.3 (4.)
 Trefferlage 2.10 mm rechts, 0.33 mm hoch
 Streuwert 1.84, horizontal: 2.00, vertikal: 1.66

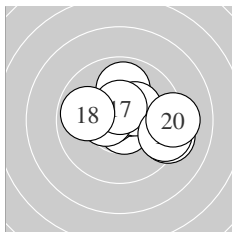

Serie 2:
 10.7 * 10.6 * 9.3 ↘ 9.9 ↑ 10.3 *
 10.5 * 10.5 * 9.9 ← 9.4 → 9.2 →
 beste Teiler 70.4 (11.) 80.0 (12.) 106.0 (17.)
 Trefferlage 0.96 mm rechts, 0.24 mm hoch
 Streuwert 1.87, horizontal: 2.39, vertikal: 1.15

Unterschrift des Schützen

Ergebnis: **201.2** (193)
 Serien: 101.3 99.9
 Zähler: 13 7 0 0 0 0 0 0 0 0
 Innenzehner: 7
 weiteste: 413 (3), 384 (11), 330 (2)
 beste Teiler 57.6 (10.) 99.2 (6.) 114.7 (5.)
 Trefferlage 0.12 mm rechts, 0.60 mm hoch
 Streuwert 1.71, horizontal: 1.96, vertikal: 1.41

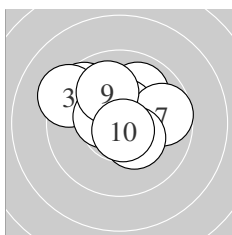
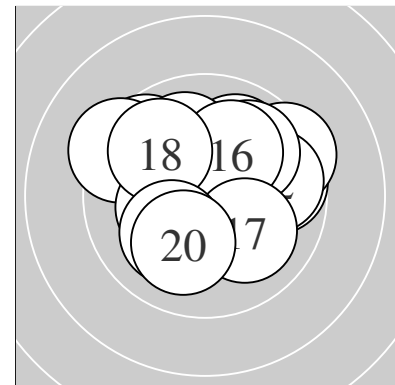

Serie 1:
 10.0 ↗ 9.6 ↘ 9.3 ↘ 10.5 * 10.5 *
 10.6 * 9.7 → 10.4 * 10.0 ↖ 10.7 *
 beste Teiler 57.6 (10.) 99.2 (6.) 114.7 (5.)
 Trefferlage 0.10 mm links, 0.85 mm hoch
 Streuwert 1.64, horizontal: 1.97, vertikal: 1.22

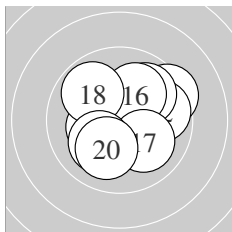

Serie 2:
 9.4 ↗ 9.8 → 9.9 ↗ 10.3 * 10.3 *
 10.1 ↗ 10.0 ↘ 9.9 ↘ 10.1 ↙ 10.1 ↙
 beste Teiler 168.2 (15.) 171.6 (14.) 213.0 (19.)
 Trefferlage 0.36 mm rechts, 0.36 mm hoch
 Streuwert 1.83, horizontal: 2.03, vertikal: 1.60

Unterschrift des Schützen

Ergebnis: **178.2** (170)
 Serien: 92.9 85.3
 Zähler: 5 7 3 3 2 0 0 0 0 0
 Innenzehner: 4
 weiteste: 1162 (13), 1007 (16), 994 (10)
 beste Teiler 71.6 (6.) 135.0 (4.) 166.0 (2.)
 Trefferlage 0.00 mm , 1.38 mm hoch
 Streuwert 4.21, horizontal: 5.16, vertikal: 2.98

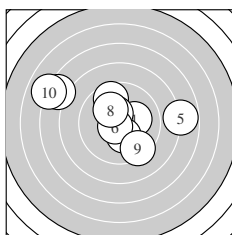
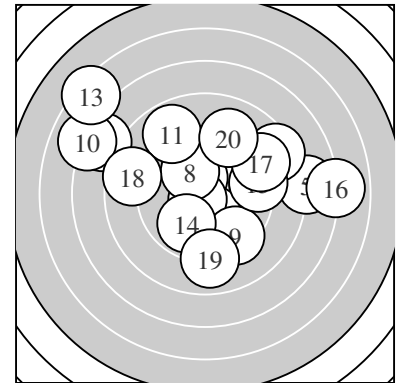

Serie 1:
 10.2 * 10.3 * 9.6 ↖ 10.4 * 7.8 →
 10.7 * 7.4 ↙ 10.1 ↖ 9.4 ↘ 7.0 ↙
 beste Teiler 71.6 (6.) 135.0 (4.) 166.0 (2.)
 Trefferlage 0.77 mm links, 1.01 mm hoch
 Streuwert 3.82, horizontal: 4.86, vertikal: 2.36

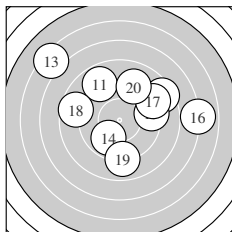

Serie 2:
 8.8 ↖ 8.4 ↗ 6.3 ↙ 9.9 ↘ 9.3 →
 6.9 → 9.0 ↗ 8.6 ↙ 9.0 ↓ 9.1 ↗
 beste Teiler 268.2 (14.) 419.1 (15.) 468.0 (20.)
 Trefferlage 0.76 mm rechts, 1.75 mm hoch
 Streuwert 4.69, horizontal: 5.59, vertikal: 3.59

Unterschrift des Schützen

Ergebnis: **194.5** (185)
 Serien: 97.4 97.1
 Zähler: 5 15 0 0 0 0 0 0 0 0
 Innenzehner: 4
 weiteste: 478 (11), 478 (14), 469 (10)
 beste Teiler 65.3 (6.) 132.6 (18.) 145.3 (12.)
 Trefferlage 1.11 mm links, 0.29 mm hoch
 Streuwert 2.22, horizontal: 1.75, vertikal: 2.61

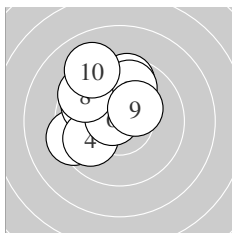
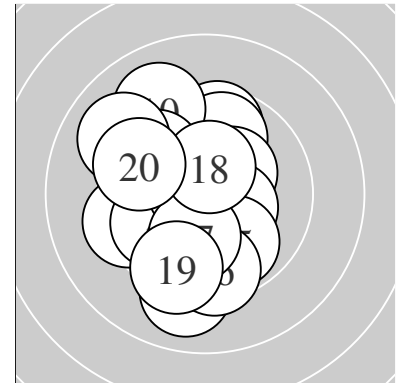

Serie 1:
 9.4 ↙ 9.3 ↘ 9.8 ↖ 9.9 ↙ 9.6 ↑
 10.7 * 9.8 ↑ 9.5 ↖ 10.3 * 9.1 ↘
 beste Teiler 65.3 (6.) 163.5 (9.) 274.4 (4.)
 Trefferlage 1.33 mm links, 1.56 mm hoch
 Streuwert 1.84, horizontal: 1.72, vertikal: 1.95

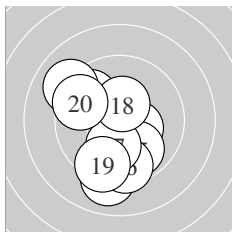

Serie 2:
 9.0 ↓ 10.4 * 9.8 ↖ 9.0 ↖ 9.9 ↘
 9.5 ↓ 10.1 ↓ 10.4 * 9.4 ↓ 9.6 ↖
 beste Teiler 132.6 (18.) 145.3 (12.) 213.1 (17.)
 Trefferlage 0.90 mm links, 0.97 mm tief
 Streuwert 2.28, horizontal: 1.83, vertikal: 2.65

Unterschrift des Schützen

Ergebnis: **155.8** (148)
 Serien: 66.3 89.5
 Zähler: 5 3 3 3 1 1 3 1 0 0
 Innenzehner: 4
 weiteste: 1857 (10), 1740 (9), 1512 (7)
 beste Teiler 98.2 (18.) 134.8 (17.) 161.9 (13.)
 Trefferlage 6.91 mm links, 0.09 mm tief
 Streuwert 4.88, horizontal: 6.52, vertikal: 2.25

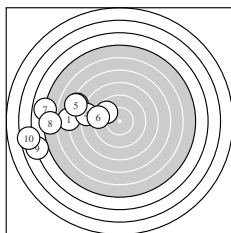
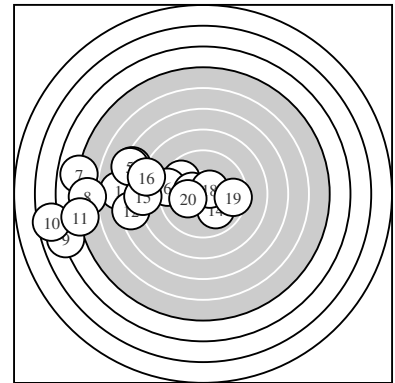

Serie 1:
 6.9 ← 7.3 ↖ 9.7 ↖ 8.2 ← 7.2 ↖
 9.2 ← 4.9 ← 5.4 ← 4.0 ← 3.5 ←
 beste Teiler 317.0 (3.) 435.5 (6.) 676.6 (4.)
 Trefferlage 10.47 mm links, 0.42 mm hoch
 Streuwert 4.24, horizontal: 5.28, vertikal: 2.84

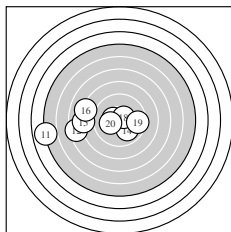

Serie 2:
 4.9 ← 7.4 ← 10.3 * 10.0 ↘ 8.1 ←
 8.1 ← 10.4 * 10.6 * 9.5 → 10.2 *
 beste Teiler 98.2 (18.) 134.8 (17.) 161.9 (13.)
 Trefferlage 3.35 mm links, 0.60 mm tief
 Streuwert 4.23, horizontal: 5.82, vertikal: 1.41

Unterschrift des Schützen

Ergebnis: **198.5** (188)
 Serien: 98.6 99.9
 Zähler: 10 8 2 0 0 0 0 0 0 0
 Innenzehner: 8
 weiteste: 661 (17), 640 (5), 367 (8)
 beste Teiler 35.4 (19.) 90.8 (20.) 118.2 (9.)
 Trefferlage 0.01 mm rechts, 1.27 mm hoch
 Streuwert 1.98, horizontal: 2.28, vertikal: 1.63

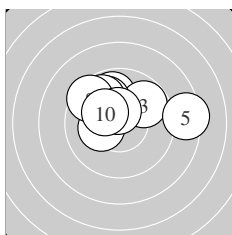
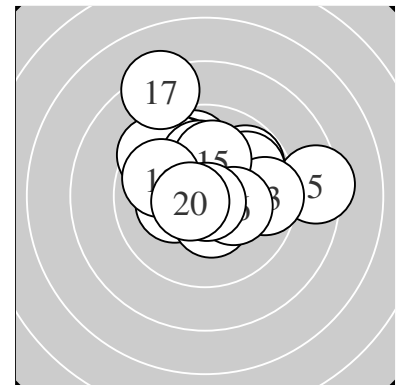

Serie 1:
 10.2 * 9.8 ↑ 9.8 ↗ 10.4 * 8.4 →
 9.9 ↘ 9.8 ↘ 9.5 ↘ 10.5 * 10.3 *
 beste Teiler 118.2 (9.) 144.5 (4.) 174.4 (10.)
 Trefferlage 0.17 mm links, 1.52 mm hoch
 Streuwert 2.01, horizontal: 2.67, vertikal: 0.97

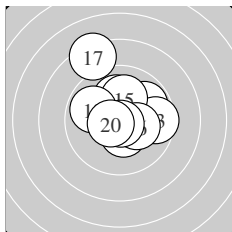

Serie 2:
 9.8 ↗ 10.4 * 9.6 → 10.1 ↑ 10.1 ↑
 10.3 * 8.3 ↘ 9.9 ↖ 10.8 * 10.6 *
 beste Teiler 35.4 (19.) 90.8 (20.) 135.1 (12.)
 Trefferlage 0.20 mm rechts, 1.02 mm hoch
 Streuwert 2.04, horizontal: 1.94, vertikal: 2.13

Unterschrift des Schützen

Ergebnis: **194.5** (186)
 Serien: 102.5 92.0
 Zähler: 8 10 2 0 0 0 0 0 0 0
 Innenzehner: 7
 weiteste: 691 (20), 600 (11), 462 (15)
 beste Teiler 39.6 (8.) 81.0 (4.) 113.3 (10.)
 Trefferlage 0.56 mm rechts, 2.02 mm tief
 Streuwert 2.04, horizontal: 2.30, vertikal: 1.73

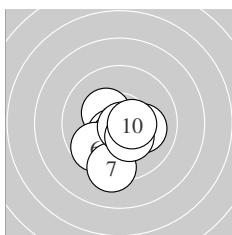
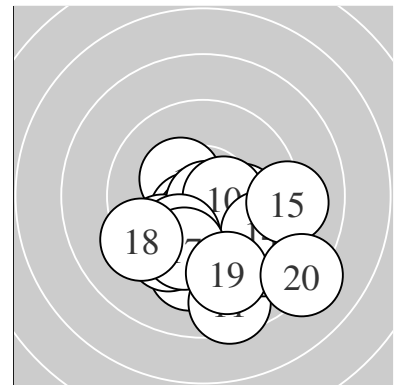

Serie 1:
 10.3 * 10.1 → 10.5 * 10.6 * 10.4 *
 9.7 ↙ 9.3 ↓ 10.8 * 10.3 * 10.5 *
 beste Teiler 39.6 (8.) 81.0 (4.) 113.3 (10.)
 Trefferlage 0.02 mm links, 1.01 mm tief
 Streuwert 1.30, horizontal: 1.26, vertikal: 1.34

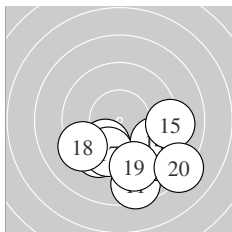

Serie 2:
 8.6 ↓ 9.5 ↙ 9.1 ↘ 9.4 ↘ 9.1 →
 9.9 ↙ 9.7 ↓ 9.3 ↙ 9.2 ↓ 8.2 ↘
 beste Teiler 252.1 (16.) 305.8 (17.) 352.5 (12.)
 Trefferlage 1.16 mm rechts, 3.03 mm tief
 Streuwert 2.35, horizontal: 2.97, vertikal: 1.51

Unterschrift des Schützen

Ergebnis: **194.3** (184)
 Serien: 95.8 98.5
 Zähler: 9 6 5 0 0 0 0 0 0 0
 Innenzehner: 7
 weiteste: 624 (12), 594 (4), 552 (3)
 beste Teiler 115.2 (18.) 117.5 (10.) 118.5 (11.)
 Trefferlage 0.26 mm links, 0.51 mm tief
 Streuwert 2.52, horizontal: 3.03, vertikal: 1.88

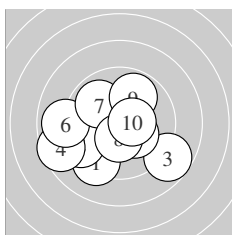
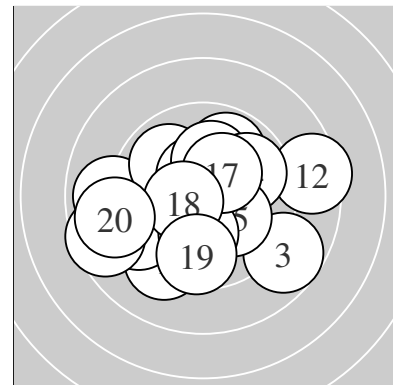

Serie 1:
 9.3 ↙ 9.3 ↖ 8.7 ↘ 8.6 ↖ 10.3 *
 8.9 ← 9.9 ↘ 10.4 * 9.9 ↗ 10.5 *
 beste Teiler 117.5 (10.) 140.2 (8.) 175.4 (5.)
 Trefferlage 0.99 mm links, 0.90 mm tief
 Streuwert 2.67, horizontal: 3.21, vertikal: 1.99

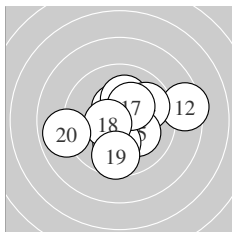

Serie 2:
 10.5 * 8.5 → 10.1 ↑ 9.8 ↗ 10.2 *
 10.1 ↓ 10.3 * 10.5 * 9.6 ↓ 8.9 ←
 beste Teiler 115.2 (18.) 118.5 (11.) 166.9 (17.)
 Trefferlage 0.46 mm rechts, 0.11 mm tief
 Streuwert 2.35, horizontal: 2.82, vertikal: 1.76

Unterschrift des Schützen

Ergebnis: **196.1** (188)
 Serien: 97.0 99.1
 Zähler: 9 10 1 0 0 0 0 0 0 0
 Innenzehner: 8
 weiteste: 595 (4), 497 (11), 470 (12)
 beste Teiler 69.6 (8.) 100.0 (16.) 100.4 (2.)
 Trefferlage 0.97 mm rechts, 1.13 mm hoch
 Streuwert 2.09, horizontal: 2.48, vertikal: 1.61

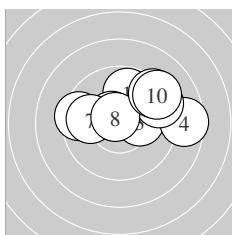
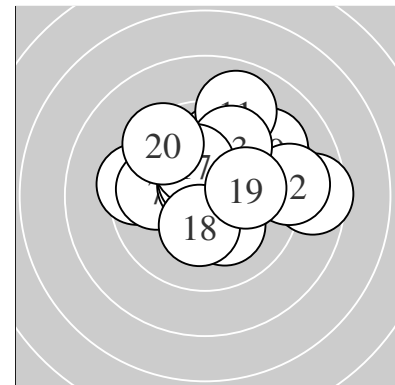

Serie 1:
 9.8 ↑ 10.6 * 10.2 * 8.6 → 9.4 ←
 9.3 ↗ 9.9 ← 10.7 * 9.3 ↗ 9.2 ↗
 beste Teiler 69.6 (8.) 100.4 (2.) 186.6 (3.)
 Trefferlage 1.11 mm rechts, 1.25 mm hoch
 Streuwert 2.29, horizontal: 3.05, vertikal: 1.12

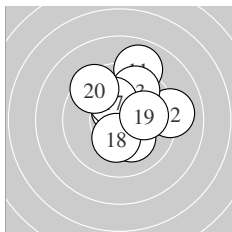

Serie 2:
 9.0 ↑ 9.1 → 9.7 ↗ 10.5 * 10.2 *
 10.6 * 10.2 * 10.3 * 10.0 → 9.5 ↘
 beste Teiler 100.0 (16.) 118.6 (14.) 165.9 (18.)
 Trefferlage 0.84 mm rechts, 1.00 mm hoch
 Streuwert 1.98, horizontal: 1.90, vertikal: 2.05

Unterschrift des Schützen

Ergebnis: **203.8** (194)
 Serien: 103.0 100.8
 Zähler: 14 6 0 0 0 0 0 0 0 0
 Innenzehner: 10
 weiteste: 426 (6), 344 (17), 326 (20)
 beste Teiler 26.9 (7.) 28.6 (2.) 58.5 (3.)
 Trefferlage 0.91 mm links, 0.00 mm
 Streuwert 1.46, horizontal: 1.28, vertikal: 1.61

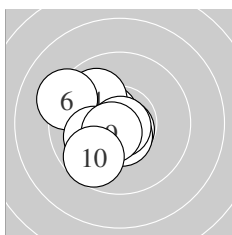
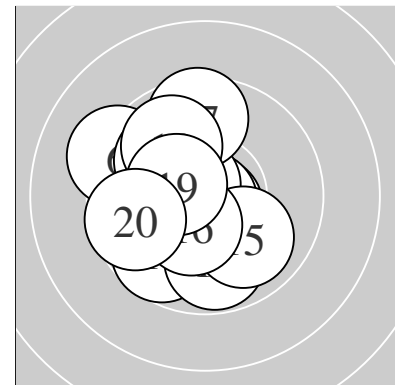

Serie 1:
 10.5 * 10.8 * 10.7 * 10.0 ↘ 10.6 *
 9.2 ↖ 10.8 * 10.1 ↙ 10.6 * 9.7 ↙
 beste Teiler 26.9 (7.) 28.6 (2.) 58.5 (3.)
 Trefferlage 1.02 mm links, 0.19 mm tief
 Streuwert 1.32, horizontal: 1.33, vertikal: 1.30

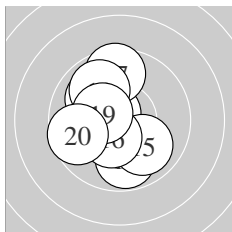

Serie 2:
 10.0 ↘ 10.5 * 10.6 * 9.8 ↓ 10.0 ↘
 10.4 * 9.6 ↑ 9.9 ↘ 10.4 * 9.6 ↙
 beste Teiler 83.0 (13.) 109.8 (12.) 136.4 (19.)
 Trefferlage 0.80 mm links, 0.18 mm hoch
 Streuwert 1.64, horizontal: 1.29, vertikal: 1.93

Unterschrift des Schützen

Ergebnis: **202.2** (193)
 Serien: 100.3 101.9
 Zähler: 14 5 1 0 0 0 0 0 0 0
 Innenzehner: 12
 weiteste: 547 (5), 488 (7), 363 (20)
 beste Teiler 61.9 (3.) 64.4 (4.) 69.3 (13.)
 Trefferlage 0.14 mm rechts, 0.46 mm hoch
 Streuwert 1.77, horizontal: 1.96, vertikal: 1.56

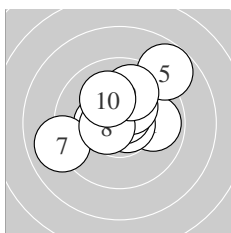
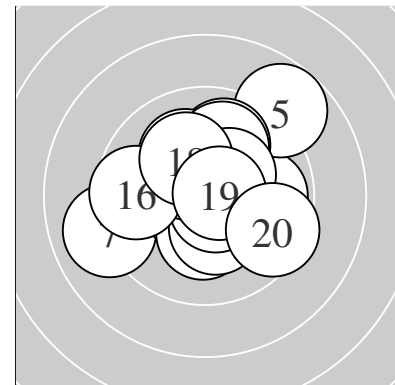

Serie 1:
 9.9 → 10.4 * 10.7 * 10.7 * 8.8 ↗
 10.3 * 9.0 ← 10.5 * 9.9 ↗ 10.1 ↘
 beste Teiler 61.9 (3.) 64.4 (4.) 103.8 (8.)
 Trefferlage 0.09 mm rechts, 0.83 mm hoch
 Streuwert 2.00, horizontal: 2.29, vertikal: 1.65

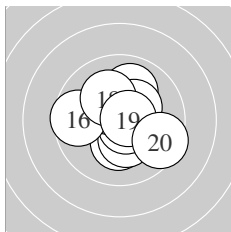

Serie 2:
 10.2 * 10.3 * 10.7 * 10.0 ↗ 10.4 *
 9.6 ← 10.3 * 10.2 * 10.7 * 9.5 ↘
 beste Teiler 69.3 (13.) 70.2 (19.) 128.9 (15.)
 Trefferlage 0.19 mm rechts, 0.10 mm hoch
 Streuwert 1.57, horizontal: 1.69, vertikal: 1.45

Unterschrift des Schützen

Ergebnis: **196.6** (189)
 Serien: 98.4 98.2
 Zähler: 11 7 2 0 0 0 0 0 0 0
 Innenzehner: 7
 weiteste: 640 (19), 519 (12), 477 (1)
 beste Teiler 64.0 (13.) 75.1 (18.) 124.9 (17.)
 Trefferlage 0.06 mm links, 0.11 mm tief
 Streuwert 2.32, horizontal: 2.73, vertikal: 1.81

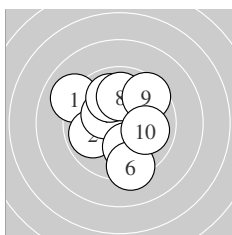
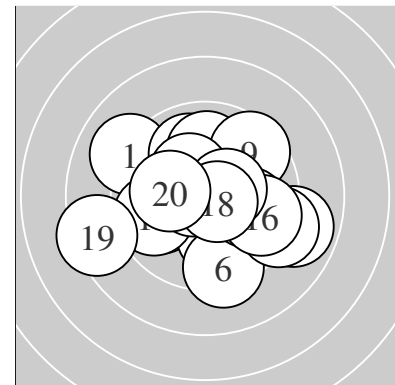

Serie 1:
 9.0 ↖ 9.9 ← 10.3 * 10.3 * 10.0 ↓
 9.3 ↓ 10.0 ↗ 10.0 ↑ 9.6 ↗ 10.0 →
 beste Teiler 156.0 (4.) 160.2 (3.) 228.7 (5.)
 Trefferlage 0.30 mm links, 0.40 mm hoch
 Streuwert 2.17, horizontal: 2.08, vertikal: 2.26

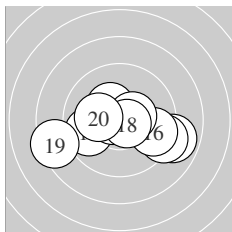

Serie 2:
 9.7 ← 8.9 → 10.7 * 10.3 * 9.2 →
 9.6 → 10.5 * 10.7 * 8.4 ← 10.2 *
 beste Teiler 64.0 (13.) 75.1 (18.) 124.9 (17.)
 Trefferlage 0.16 mm rechts, 0.62 mm tief
 Streuwert 2.50, horizontal: 3.36, vertikal: 1.11

Unterschrift des Schützen

Ergebnis: **190.8** (180)
 Serien: 92.3 98.5
 Zähler: 4 12 4 0 0 0 0 0 0 0
 Innenzehner: 4
 weiteste: 618 (5), 581 (14), 542 (2)
 beste Teiler 101.1 (18.) 104.9 (11.) 162.7 (12.)
 Trefferlage 0.58 mm rechts, 0.15 mm hoch
 Streuwert 2.73, horizontal: 3.40, vertikal: 1.82

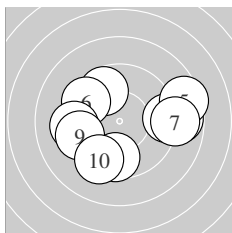
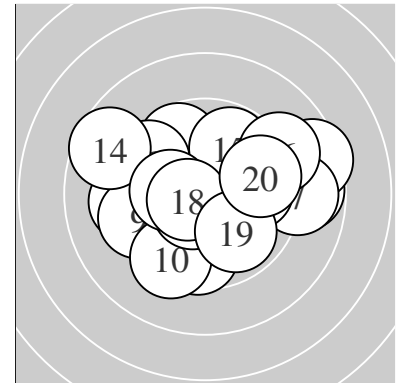

Serie 1:
 9.7 ↖ 8.8 → 9.6 ↓ 9.2 → 8.5 →
 9.5 ↗ 8.9 → 9.3 ← 9.4 ← 9.4 ↙
 beste Teiler 310.8 (1.) 332.2 (3.) 356.7 (6.)
 Trefferlage 0.61 mm rechts, 0.16 mm tief
 Streuwert 3.25, horizontal: 4.10, vertikal: 2.09

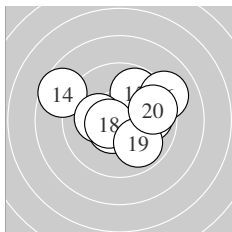

Serie 2:
 10.5 * 10.3 * 9.9 → 8.6 ↖ 9.8 ↗
 9.1 ↗ 10.2 * 10.5 * 9.9 ↘ 9.7 →
 beste Teiler 101.1 (18.) 104.9 (11.) 162.7 (12.)
 Trefferlage 0.54 mm rechts, 0.47 mm hoch
 Streuwert 2.25, horizontal: 2.77, vertikal: 1.56

Unterschrift des Schützen

Ergebnis: **179.6** (169)
 Serien: 88.0 91.6
 Zähler: 2 11 4 1 1 1 0 0 0 0
 Innenzehner: 2
 weiteste: 1256 (7), 1021 (16), 948 (10)
 beste Teiler 86.8 (1.) 126.1 (9.) 267.0 (4.)
 Trefferlage 1.15 mm links, 1.68 mm tief
 Streuwert 3.86, horizontal: 5.14, vertikal: 1.85

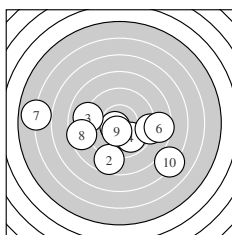
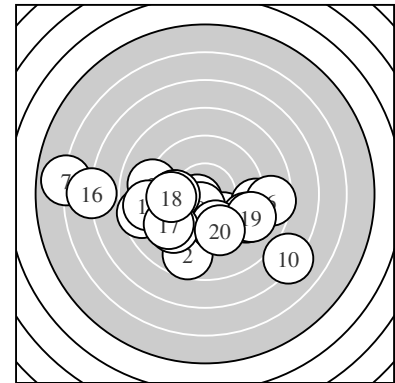

Serie 1:
 10.6 * 8.7 ↙ 9.0 ← 9.9 ↘ 9.1 →
 8.6 → 5.9 ← 8.6 ← 10.4 * 7.2 ↘
 beste Teiler 86.8 (1.) 126.1 (9.) 267.0 (4.)
 Trefferlage 0.59 mm links, 1.61 mm tief
 Streuwert 4.57, horizontal: 6.02, vertikal: 2.35

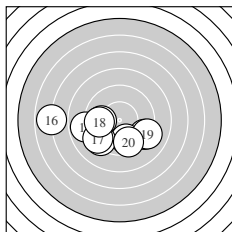

Serie 2:
 8.9 ← 9.9 ← 9.2 ↘ 9.8 ↓ 9.3 ↙
 6.9 ← 9.3 ↙ 9.7 ← 9.1 ↘ 9.5 ↓
 beste Teiler 272.1 (12.) 298.5 (14.) 305.2 (18.)
 Trefferlage 1.70 mm links, 1.74 mm tief
 Streuwert 3.21, horizontal: 4.35, vertikal: 1.29

Unterschrift des Schützen

Ergebnis: **174.1** (165)
 Serien: 79.8 94.3
 Zähler: 4 6 5 3 0 2 0 0 0 0
 Innenzehner: 2
 weiteste: 1439 (9), 1395 (7), 974 (4)
 beste Teiler 83.6 (11.) 120.1 (13.) 227.4 (6.)
 Trefferlage 1.25 mm links, 1.21 mm tief
 Streuwert 4.74, horizontal: 5.91, vertikal: 3.16

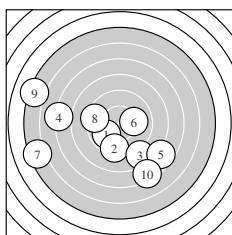
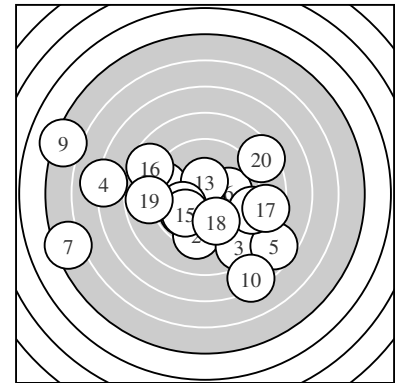

Serie 1:
 9.9 ↙ 9.3 ↓ 8.6 ↘ 7.1 ← 7.7 ↘
 10.0 → 5.4 ← 9.3 ← 5.2 ↖ 7.3 ↘
 beste Teiler 227.4 (6.) 272.7 (1.) 403.2 (2.)
 Trefferlage 2.67 mm links, 2.16 mm tief
 Streuwert 5.83, horizontal: 7.27, vertikal: 3.89

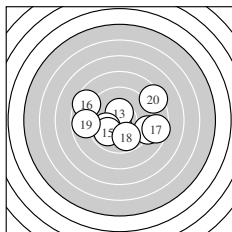

Serie 2:
 10.6 * 9.1 → 10.5 * 10.0 ← 9.9 ↙
 8.6 ↖ 8.6 → 9.8 ↓ 8.8 ← 8.4 ↗
 beste Teiler 83.6 (11.) 120.1 (13.) 239.7 (14.)
 Trefferlage 0.16 mm rechts, 0.26 mm tief
 Streuwert 3.19, horizontal: 4.06, vertikal: 1.98

Unterschrift des Schützen

Ergebnis: **187.2** (177)
 Serien: 97.7 89.5
 Zähler: 8 7 1 2 2 0 0 0 0 0
 Innenzehner: 5
 weiteste: 1012 (14), 1006 (20), 911 (18)
 beste Teiler 55.8 (8.) 90.2 (3.) 161.2 (2.)
 Trefferlage 0.16 mm rechts, 0.66 mm hoch
 Streuwert 3.56, horizontal: 4.79, vertikal: 1.54

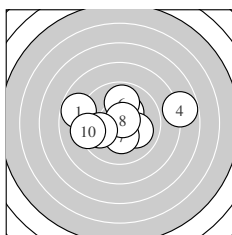
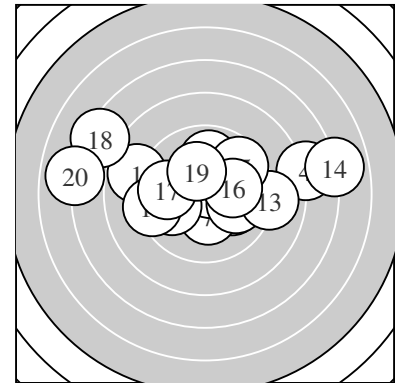

Serie 1:
 8.8 ↖ 10.3 * 10.6 * 7.8 → 10.1 ↘
 9.9 ↑ 10.3 * 10.7 * 9.9 ← 9.3 ←
 beste Teiler 55.8 (8.) 90.2 (3.) 161.2 (2.)
 Trefferlage 0.01 mm links, 0.23 mm hoch
 Streuwert 2.74, horizontal: 3.57, vertikal: 1.49

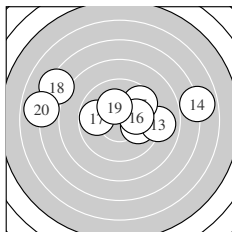

Serie 2:
 9.7 → 10.0 → 9.0 → 6.9 → 9.6 ↗
 10.1 → 9.8 ← 7.3 ↖ 10.2 * 6.9 ←

beste Teiler 184.4 (19.) 216.7 (16.) 247.9 (12.)
 Trefferlage 0.35 mm rechts, 1.09 mm hoch
 Streuwert 4.36, horizontal: 5.97, vertikal: 1.53

Unterschrift des Schützen

Ergebnis: **180.3** (173)
 Serien: 91.7 88.6
 Zähler: 7 4 5 3 1 0 0 0 0 0
 Innenzehner: 5
 weiteste: 1086 (14), 948 (6), 895 (10)
 beste Teiler 82.7 (2.) 89.8 (4.) 140.5 (20.)
 Trefferlage 2.19 mm rechts, 1.36 mm hoch
 Streuwert 3.73, horizontal: 4.93, vertikal: 1.90

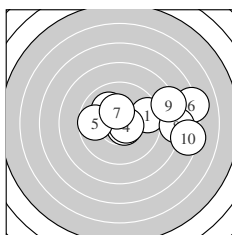
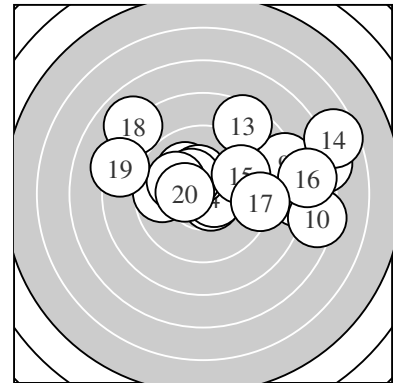

Serie 1:
 9.5 → 10.6 * 10.1 ↖ 10.6 * 9.7 ←
 7.2 → 10.3 * 8.0 → 8.3 → 7.4 →
 beste Teiler 82.7 (2.) 89.8 (4.) 154.0 (7.)
 Trefferlage 3.17 mm rechts, 0.60 mm hoch
 Streuwert 3.31, horizontal: 4.46, vertikal: 1.40

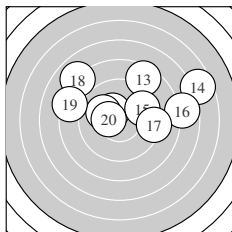

Serie 2:
 10.3 * 10.0 ↖ 8.5 ↗ 6.6 → 9.6 →
 7.7 → 9.2 → 8.0 ↖ 8.3 ↖ 10.4 *
 beste Teiler 140.5 (20.) 151.6 (11.) 230.3 (12.)
 Trefferlage 1.22 mm rechts, 2.13 mm hoch
 Streuwert 4.10, horizontal: 5.40, vertikal: 2.09

Unterschrift des Schützen

Ergebnis: **189.8** (182)
 Serien: 92.0 97.8
 Zähler: 7 9 3 1 0 0 0 0 0 0
 Innenzehner: 4
 weiteste: 871 (9), 626 (11), 594 (3)
 beste Teiler 50.2 (13.) 159.6 (16.) 163.8 (12.)
 Trefferlage 0.88 mm links, 1.61 mm hoch
 Streuwert 2.67, horizontal: 3.55, vertikal: 1.28

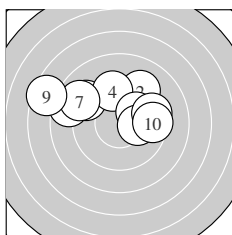
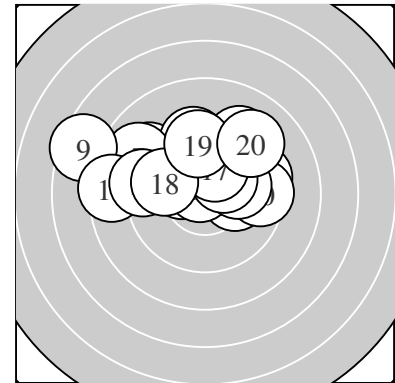

Serie 1:
 9.1 ↘ 9.2 ↗ 8.6 ↖ 9.5 ↑ 10.1 ↗
 10.1 → 8.9 ↖ 9.5 → 7.5 ↖ 9.5 →
 beste Teiler 201.3 (6.) 220.4 (5.) 366.6 (4.)
 Trefferlage 0.93 mm links, 1.94 mm hoch
 Streuwert 3.16, horizontal: 4.26, vertikal: 1.37

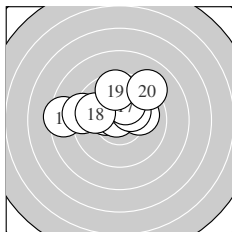

Serie 2:
 8.4 ← 10.3 * 10.8 * 10.0 → 9.3 ←
 10.3 * 10.2 * 9.8 ← 9.6 ↑ 9.1 ↗
 beste Teiler 50.2 (13.) 159.6 (16.) 163.8 (12.)
 Trefferlage 0.83 mm links, 1.28 mm hoch
 Streuwert 2.21, horizontal: 2.90, vertikal: 1.16

Unterschrift des Schützen

Ergebnis: **183.0** (173)
 Serien: 93.6 89.4
 Zähler: 4 7 7 2 0 0 0 0 0 0
 Innenzehner: 3
 weiteste: 839 (17), 786 (4), 700 (7)
 beste Teiler 120.8 (6.) 145.4 (10.) 197.6 (15.)
 Trefferlage 1.00 mm rechts, 1.97 mm tief
 Streuwert 3.23, horizontal: 4.25, vertikal: 1.68

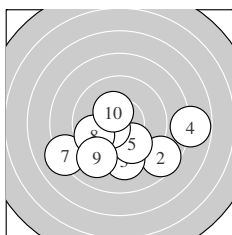
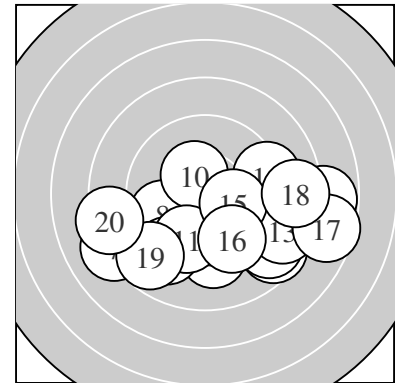

Serie 1:
 10.1 ↙ 8.6 ↘ 9.3 ↓ 7.8 → 9.9 ↘
 10.5 * 8.2 ↙ 9.7 ↙ 9.1 ↙ 10.4 *
 beste Teiler 120.8 (6.) 145.4 (10.) 217.3 (1.)
 Trefferlage 0.01 mm rechts, 2.01 mm tief
 Streuwert 3.04, horizontal: 3.92, vertikal: 1.77

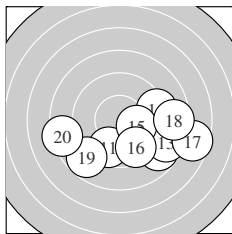

Serie 2:
 9.7 ↙ 8.8 ↘ 8.7 ↘ 9.2 → 10.2 *
 9.6 ↘ 7.6 → 8.5 → 8.8 ↙ 8.3 ←
 beste Teiler 197.6 (15.) 325.1 (11.) 349.3 (16.)
 Trefferlage 2.00 mm rechts, 1.92 mm tief
 Streuwert 3.42, horizontal: 4.54, vertikal: 1.67

Unterschrift des Schützen

Ergebnis: **200.2** (192)
 Serien: 99.9 100.3
 Zähler: 13 6 1 0 0 0 0 0 0 0
 Innenzehner: 10
 weiteste: 579 (11), 461 (3), 439 (4)
 beste Teiler 32.3 (16.) 66.4 (5.) 76.1 (20.)
 Trefferlage 0.64 mm links, 0.51 mm tief
 Streuwert 1.87, horizontal: 2.22, vertikal: 1.44

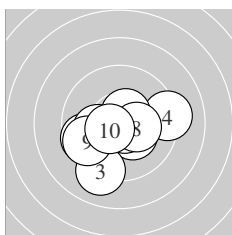
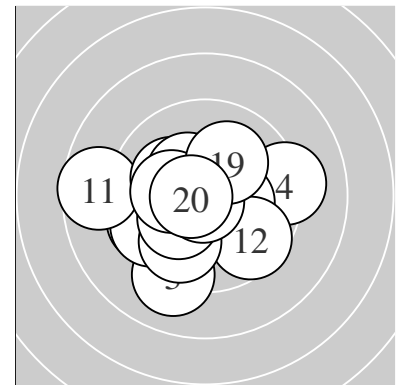

Serie 1:
 10.3 * 9.6 ← 9.1 ↙ 9.2 → 10.7 *
 10.1 ← 10.5 * 10.3 * 9.6 ← 10.5 *
 beste Teiler 66.4 (5.) 103.4 (10.) 104.3 (7.)
 Trefferlage 0.25 mm links, 0.86 mm tief
 Streuwert 1.93, horizontal: 2.32, vertikal: 1.43

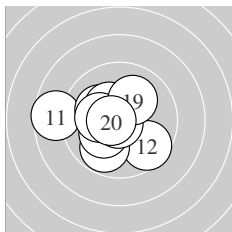

Serie 2:
 8.6 ← 9.6 ↘ 9.8 ↙ 10.2 * 10.1 ↘
 10.8 * 10.3 * 10.2 * 10.1 ↗ 10.6 *
 beste Teiler 32.3 (16.) 76.1 (20.) 153.0 (17.)
 Trefferlage 1.03 mm links, 0.16 mm tief
 Streuwert 1.83, horizontal: 2.16, vertikal: 1.43

Unterschrift des Schützen

Ergebnis: **168.7** (160)
 Serien: 86.9 81.8
 Zähler: 4 5 6 3 0 1 0 0 0 1
 Innenzehner: 3
 weiteste: 2312 (3), 1314 (11), 955 (17)
 beste Teiler 114.1 (16.) 134.1 (5.) 172.8 (8.)
 Trefferlage 4.05 mm rechts, 1.15 mm tief
 Streuwert 4.92, horizontal: 6.31, vertikal: 2.94

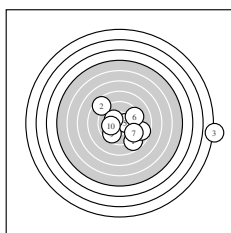
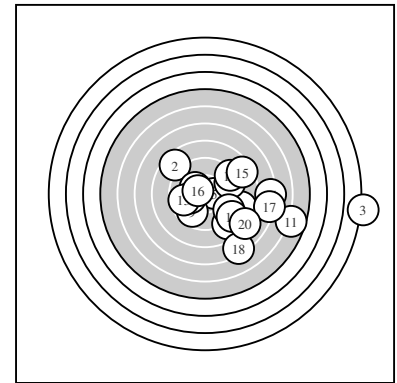

Serie 1:
 8.8 ↘ 8.5 ↘ 1.7 → 8.7 → 10.4 *
 9.4 → 9.3 ↘ 10.3 * 9.7 ↙ 10.1 ←
 beste Teiler 134.1 (5.) 172.8 (8.) 218.8 (10.)
 Trefferlage 3.01 mm rechts, 0.71 mm tief
 Streuwert 5.72, horizontal: 7.69, vertikal: 2.49

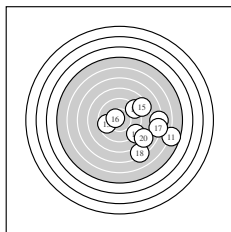

Serie 2:
 5.7 → 9.1 ↗ 9.7 ← 7.1 → 8.4 ↗
 10.5 * 7.1 → 7.2 ↘ 8.9 ↘ 8.1 ↘
 beste Teiler 114.1 (16.) 321.5 (13.) 455.4 (12.)
 Trefferlage 5.09 mm rechts, 1.59 mm tief
 Streuwert 4.13, horizontal: 4.74, vertikal: 3.41

Unterschrift des Schützen

Ergebnis: **196.6** (188)
 Serien: 99.0 97.6
 Zähler: 8 12 0 0 0 0 0 0 0 0
 Innenzehner: 6
 weiteste: 487 (20), 476 (13), 395 (12)
 beste Teiler 107.1 (1.) 110.1 (10.) 144.5 (16.)
 Trefferlage 0.11 mm links, 0.41 mm tief
 Streuwert 2.16, horizontal: 2.47, vertikal: 1.80

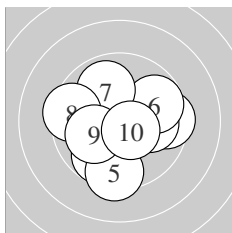
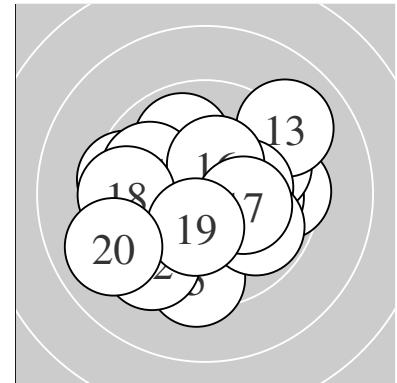

Serie 1:
 10.5 * 9.5 → 9.8 ↙ 10.0 → 9.4 ↓
 9.8 ↗ 9.9 ↖ 9.5 ← 10.1 ← 10.5 *
 beste Teiler 107.1 (1.) 110.1 (10.) 219.1 (9.)
 Trefferlage 0.09 mm rechts, 0.49 mm tief
 Streuwert 2.06, horizontal: 2.27, vertikal: 1.82

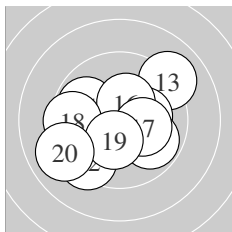

Serie 2:
 9.8 ↖ 9.4 ↙ 9.0 ↗ 10.2 * 9.8 ↘
 10.4 * 10.2 * 9.5 ← 10.3 * 9.0 ↖
 beste Teiler 144.5 (16.) 159.2 (19.) 184.4 (14.)
 Trefferlage 0.31 mm links, 0.33 mm tief
 Streuwert 2.36, horizontal: 2.76, vertikal: 1.88

Unterschrift des Schützen

Ergebnis: **160** (169.6)
 Serien: 81 79
 Zähler: 4 7 3 3 1 0 1 0 1 0
 Innenzehner: 2
 weiteste: 6645 (10), 5176 (12), 3342 (2)
 beste Teiler 467.6 (11.) 469.5 (9.) 503.4 (3.)
 Trefferlage 6.58 mm rechts, 6.76 mm tief
 Streuwert 16.98, horizontal: 6.70, vertikal: 23.06

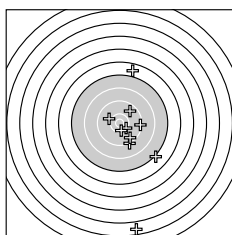
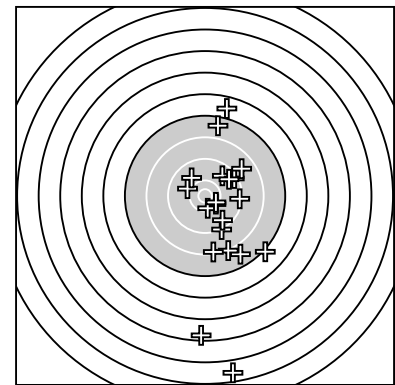

Serie 1:
 9.2 ↘ 6.8 ↑ 10.3 ↘ 9.6 ↘ 7.1 ↘
 9.7 ↗ 10.1 ↖ 9.3 → 10.4 * 2.6 ↓
 beste Teiler 469.5 (9.) 503.4 (3.) 704.7 (7.)
 Trefferlage 7.11 mm rechts, 7.39 mm tief
 Streuwert 18.39, horizontal: 7.54, vertikal: 24.89

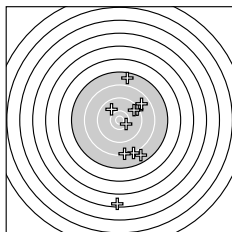

Serie 2:
 10.4 * 4.5 ↓ 7.6 ↑ 9.4 ↗ 9.6 ↗
 7.8 ↘ 8.2 ↘ 8.8 ↗ 9.9 ↖ 8.3 ↓
 beste Teiler 467.6 (11.) 834.6 (19.) 1082.7 (15.)
 Trefferlage 6.04 mm rechts, 6.13 mm tief
 Streuwert 16.43, horizontal: 6.12, vertikal: 22.42

Unterschrift des Schützen

Ergebnis: **175.3** (167)
 Serien: 89.8 85.5
 Zähler: 3 6 10 0 0 0 0 1 0 0
 Innenzehner: 2
 weiteste: 1953 (19), 709 (6), 653 (9)
 beste Teiler 152.1 (7.) 165.3 (12.) 215.2 (14.)
 Trefferlage 1.30 mm rechts, 2.55 mm tief
 Streuwert 4.25, horizontal: 5.31, vertikal: 2.81

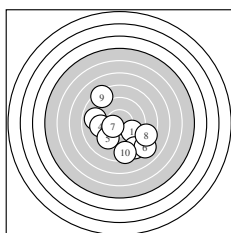
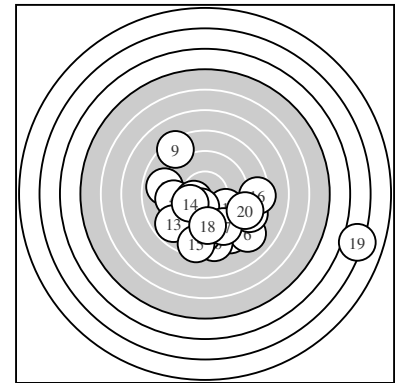

Serie 1:
 9.7 ↘ 8.6 ↘ 8.9 ← 9.4 ← 9.4 ↙
 8.1 ↘ 10.3 * 8.6 → 8.3 ↖ 8.5 ↓
 beste Teiler 152.1 (7.) 301.5 (1.) 381.0 (5.)
 Trefferlage 0.12 mm rechts, 1.77 mm tief
 Streuwert 3.61, horizontal: 3.85, vertikal: 3.35

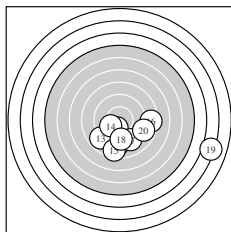

Serie 2:
 9.0 ↓ 10.3 * 8.8 ↙ 10.1 ↙ 8.5 ↓
 8.4 → 9.1 ↘ 9.4 ↓ 3.1 → 8.8 →
 beste Teiler 165.3 (12.) 215.2 (14.) 388.2 (18.)
 Trefferlage 2.48 mm rechts, 3.33 mm tief
 Streuwert 4.78, horizontal: 6.45, vertikal: 2.03

Unterschrift des Schützen

Ergebnis: **201.2** (192)
 Serien: 102.4 98.8
 Zähler: 13 6 1 0 0 0 0 0 0 0
 Innenzehner: 9
 weiteste: 607 (18), 423 (7), 308 (20)
 beste Teiler 26.4 (10.) 80.2 (4.) 82.0 (3.)
 Trefferlage 0.28 mm rechts, 0.38 mm tief
 Streuwert 1.83, horizontal: 2.24, vertikal: 1.28

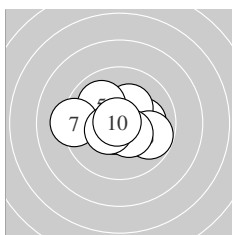
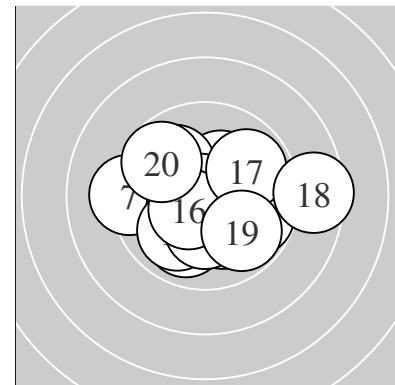

Serie 1:
 10.1 → 10.3 * 10.6 * 10.6 * 10.0 ↖
 9.8 ↘ 9.3 ← 10.4 * 10.5 * 10.8 *
 beste Teiler 26.4 (10.) 80.2 (4.) 82.0 (3.)
 Trefferlage 0.16 mm links, 0.05 mm tief
 Streuwert 1.56, horizontal: 1.99, vertikal: 0.96

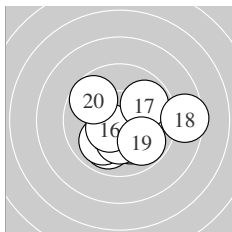

Serie 2:
 9.9 ↙ 10.0 ↙ 10.2 * 10.1 ↘ 10.2 *
 10.5 * 9.9 ↗ 8.5 → 9.8 ↘ 9.7 ↖
 beste Teiler 118.0 (16.) 184.0 (15.) 189.3 (13.)
 Trefferlage 0.73 mm rechts, 0.71 mm tief
 Streuwert 2.06, horizontal: 2.49, vertikal: 1.52

Unterschrift des Schützen

Ergebnis: **189.3** (183)
 Serien: 92.7 96.6
 Zähler: 11 3 4 2 0 0 0 0 0 0
 Innenzehner: 6
 weiteste: 993 (10), 851 (20), 683 (4)
 beste Teiler 72.4 (17.) 135.2 (5.) 140.2 (12.)
 Trefferlage 1.90 mm rechts, 1.30 mm tief
 Streuwert 2.79, horizontal: 3.61, vertikal: 1.59

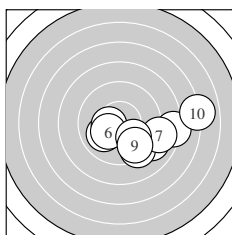
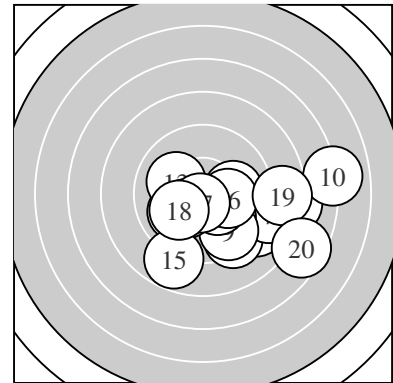

Serie 1:
 10.0 ↙ 9.1 ↘ 9.3 ↘ 8.2 → 10.4 *
 10.2 * 8.9 → 10.0 ↘ 9.6 ↘ 7.0 →
 beste Teiler 135.2 (5.) 176.8 (6.) 239.6 (1.)
 Trefferlage 2.68 mm rechts, 1.38 mm tief
 Streuwert 2.87, horizontal: 3.82, vertikal: 1.37

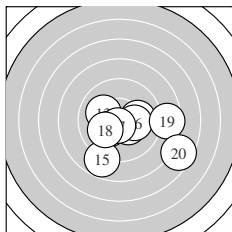

Serie 2:
 10.0 → 10.4 * 10.1 ↖ 10.3 * 8.8 ↙
 10.2 * 10.7 * 10.1 ↙ 8.5 → 7.5 ↘
 beste Teiler 72.4 (17.) 140.2 (12.) 170.8 (14.)
 Trefferlage 1.11 mm rechts, 1.22 mm tief
 Streuwert 2.74, horizontal: 3.39, vertikal: 1.86

Unterschrift des Schützen

Ergebnis: **196.3** (188)
 Serien: 97.0 99.3
 Zähler: 10 8 2 0 0 0 0 0 0 0
 Innenzehner: 9
 weiteste: 527 (8), 519 (5), 474 (7)
 beste Teiler 36.0 (15.) 67.7 (17.) 88.2 (18.)
 Trefferlage 1.40 mm rechts, 0.34 mm tief
 Streuwert 2.14, horizontal: 2.83, vertikal: 1.06

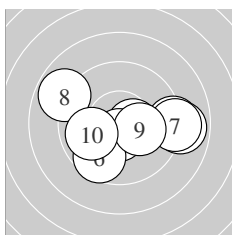
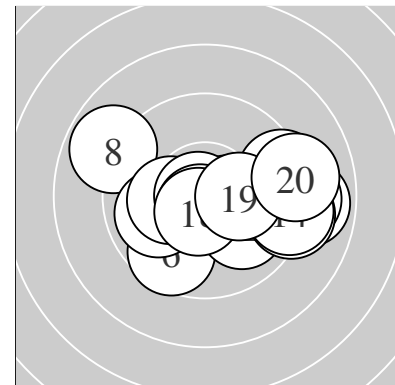

Serie 1:
 10.4 * 9.1 → 10.5 * 10.5 * 8.9 →
 9.6 ↙ 9.1 → 8.8 ↖ 10.2 * 9.9 ←
 beste Teiler 101.1 (4.) 115.2 (3.) 146.1 (1.)
 Trefferlage 0.98 mm rechts, 0.40 mm tief
 Streuwert 2.50, horizontal: 3.29, vertikal: 1.28

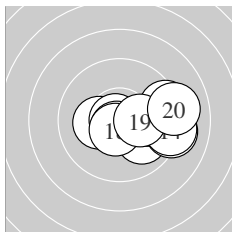

Serie 2:
 10.2 * 10.0 ↘ 9.1 → 9.2 → 10.8 *
 9.3 → 10.7 * 10.6 * 10.3 * 9.1 →
 beste Teiler 36.0 (15.) 67.7 (17.) 88.2 (18.)
 Trefferlage 1.82 mm rechts, 0.28 mm tief
 Streuwert 1.80, horizontal: 2.40, vertikal: 0.84

Unterschrift des Schützen

Ergebnis: **198.9** (189)
 Serien: 100.3 98.6
 Zähler: 9 11 0 0 0 0 0 0 0 0
 Innenzehner: 6
 weiteste: 497 (13), 405 (17), 356 (18)
 beste Teiler 75.2 (1.) 84.4 (19.) 184.0 (9.)
 Trefferlage 0.96 mm links, 0.55 mm tief
 Streuwert 1.78, horizontal: 2.29, vertikal: 1.06

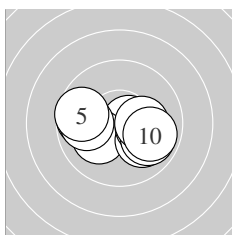
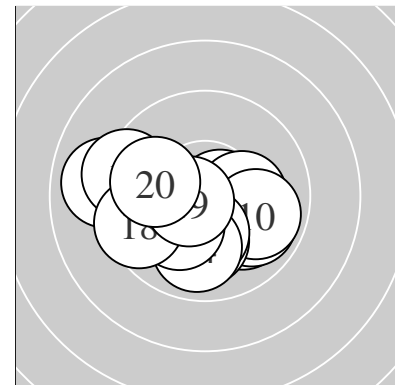

Serie 1:
 10.7 * 9.7 ← 10.1 ↙ 9.9 ← 9.7 ←
 10.0 ↘ 10.2 * 9.9 ↘ 10.2 * 9.9 ↘
 beste Teiler 75.2 (1.) 184.0 (9.) 191.0 (7.)
 Trefferlage 0.05 mm rechts, 0.39 mm tief
 Streuwert 1.78, horizontal: 2.41, vertikal: 0.74

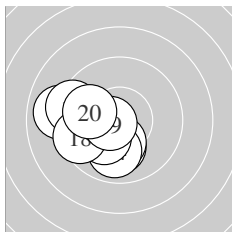

Serie 2:
 10.1 ↓ 10.2 * 9.0 ← 9.9 ↓ 10.2 *
 9.9 ← 9.3 ← 9.5 ← 10.6 * 9.9 ←
 beste Teiler 84.4 (19.) 184.0 (12.) 192.7 (15.)
 Trefferlage 1.98 mm links, 0.70 mm tief
 Streuwert 1.54, horizontal: 1.72, vertikal: 1.33

Unterschrift des Schützen

Ergebnis: **206.2** (198)
 Serien: 104.3 101.9
 Zähler: 18 2 0 0 0 0 0 0 0 0
 Innenzehner: 14
 weiteste: 443 (18), 257 (13), 246 (9)
 beste Teiler 35.2 (2.) 62.0 (4.) 74.2 (6.)
 Trefferlage 0.64 mm links, 0.21 mm tief
 Streuwert 1.26, horizontal: 1.62, vertikal: 0.76

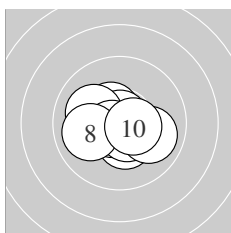
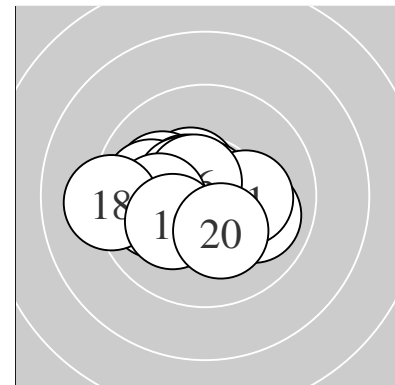

Serie 1:
 10.5 * 10.8 * 10.1 ↖ 10.7 * 10.4 *
 10.7 * 10.6 * 10.0 ← 10.0 → 10.5 *
 beste Teiler 35.2 (2.) 62.0 (4.) 74.2 (6.)
 Trefferlage 0.11 mm links, 0.29 mm tief
 Streuwert 1.11, horizontal: 1.37, vertikal: 0.77

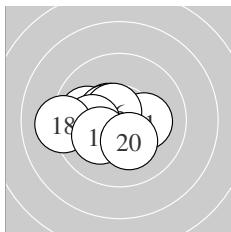

Serie 2:
 10.2 * 10.5 * 9.9 ← 10.5 * 10.5 *
 10.6 * 10.1 ← 9.2 ← 10.2 * 10.2 *
 beste Teiler 82.6 (16.) 108.6 (12.) 115.8 (15.)
 Trefferlage 1.16 mm links, 0.13 mm tief
 Streuwert 1.35, horizontal: 1.74, vertikal: 0.78

Unterschrift des Schützen

Ergebnis: **170.7** (161)
 Serien: 82.7 88.0
 Zähler: 3 8 4 2 1 0 1 1 0 0
 Innenzehner: 1
 weiteste: 1950 (9), 1552 (13), 1031 (4)
 beste Teiler 69.8 (18.) 214.4 (12.) 224.7 (2.)
 Trefferlage 2.73 mm rechts, 1.63 mm hoch
 Streuwert 4.99, horizontal: 6.46, vertikal: 2.86

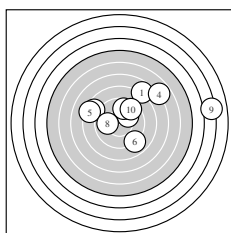
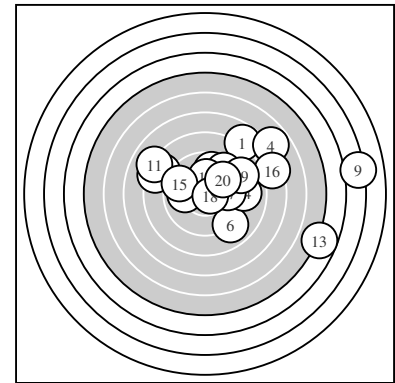

Serie 1:
 7.8 ↗ 10.1 ↗ 8.5 ↖ 6.8 ↗ 8.3 ↖
 9.0 ↘ 9.7 ↑ 9.9 ← 3.2 → 9.4 ↗
 beste Teiler 224.7 (2.) 252.0 (8.) 314.8 (7.)
 Trefferlage 2.62 mm rechts, 2.42 mm hoch
 Streuwert 5.60, horizontal: 7.36, vertikal: 2.94

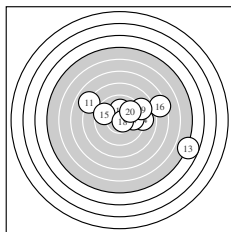

Serie 2:
 8.0 ↖ 10.1 ↑ 4.7 ↘ 9.0 → 9.6 ↖
 7.4 → 9.8 → 10.7 * 8.9 ↗ 9.8 ↗
 beste Teiler 69.8 (18.) 214.4 (12.) 287.6 (17.)
 Trefferlage 2.85 mm rechts, 0.84 mm hoch
 Streuwert 4.53, horizontal: 5.83, vertikal: 2.68

Unterschrift des Schützen

Ergebnis: **198.7** (190)
 Serien: 102.4 96.3
 Zähler: 13 4 3 0 0 0 0 0 0 0
 Innenzehner: 7
 weiteste: 616 (14), 571 (20), 534 (16)
 beste Teiler 66.2 (6.) 69.2 (10.) 89.0 (2.)
 Trefferlage 0.62 mm links, 0.48 mm hoch
 Streuwert 2.12, horizontal: 2.79, vertikal: 1.09

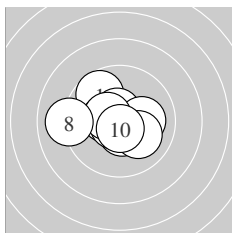
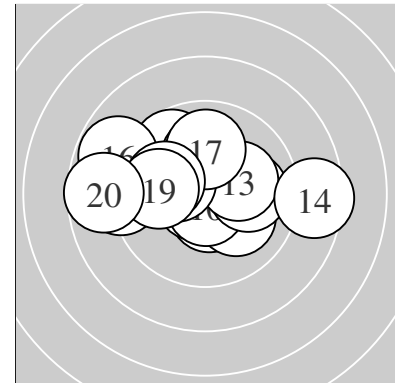

Serie 1:
 9.7 ↘ 10.6 * 10.1 → 10.5 * 10.4 *
 10.7 * 10.5 * 9.1 ← 10.1 ↘ 10.7 *
 beste Teiler 66.2 (6.) 69.2 (10.) 89.0 (2.)
 Trefferlage 0.57 mm links, 0.07 mm hoch
 Streuwert 1.57, horizontal: 1.93, vertikal: 1.08

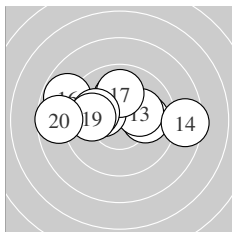

Serie 2:
 10.1 ↑ 10.0 → 10.1 ↗ 8.5 → 10.3 *
 8.8 ↙ 9.9 ↑ 10.0 ← 9.9 ← 8.7 ←
 beste Teiler 175.6 (15.) 201.6 (13.) 211.2 (11.)
 Trefferlage 0.68 mm links, 0.90 mm hoch
 Streuwert 2.61, horizontal: 3.56, vertikal: 0.98

Unterschrift des Schützen

Ergebnis: **392.8** (375)
 Serien: 95.5 96.9 100.0 100.4
 Zähler: 21 13 6 0 0 0 0 0 0 0
 Innenzehner: 17
 weiteste: 731 (30), 639 (5), 632 (6)
 beste Teiler 14.8 (28.) 47.2 (13.) 59.4 (18.)
 Trefferlage 0.06 mm links, 0.15 mm tief
 Streuwert 2.42, horizontal: 3.17, vertikal: 1.28

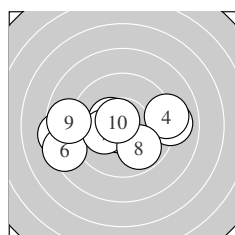
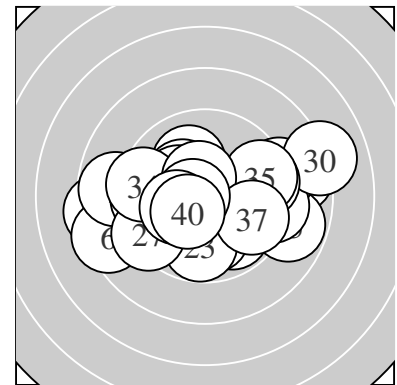

Serie 1:
 10.7 * 10.4 * 9.0 → 9.1 → 8.4 ←
 8.4 ← 10.2 * 9.8 ↘ 8.8 ← 10.7 *
 beste Teiler 68.7 (10.) 70.1 (1.) 134.7 (2.)
 Trefferlage 1.07 mm links, 0.42 mm tief
 Streuwert 2.94, horizontal: 3.99, vertikal: 1.15

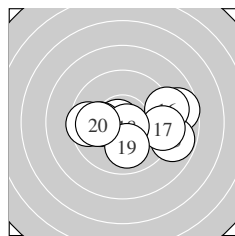

Serie 2:
 8.7 → 9.6 ← 10.8 * 10.0 ← 8.8 →
 9.1 → 9.3 → 10.7 * 10.0 ↓ 9.9 ←
 beste Teiler 47.2 (13.) 59.4 (18.) 228.9 (14.)
 Trefferlage 1.12 mm rechts, 0.31 mm tief
 Streuwert 2.53, horizontal: 3.40, vertikal: 1.13

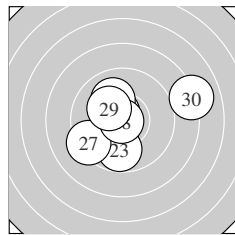

Serie 3:
 10.0 ↓ 10.5 * 9.8 ↓ 10.6 * 10.6 *
 10.1 ↘ 9.3 ← 10.9 * 10.2 * 8.0 →
 beste Teiler 14.8 (28.) 94.5 (24.) 97.8 (25.)
 Trefferlage 0.21 mm links, 0.03 mm tief
 Streuwert 2.31, horizontal: 2.68, vertikal: 1.87

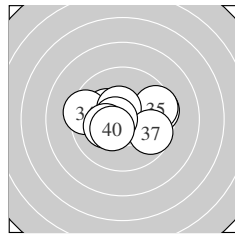

Serie 4:
 9.5 → 10.3 * 10.2 * 9.4 ← 9.5 →
 10.5 * 9.7 ↘ 10.7 * 10.2 * 10.4 *
 beste Teiler 75.0 (38.) 114.1 (36.) 142.3 (40.)
 Trefferlage 0.11 mm links, 0.16 mm hoch
 Streuwert 1.86, horizontal: 2.47, vertikal: 0.89

Unterschrift des Schützen

Meyton Elektronik