

Ergebnis:	609.6	(581)
Serien:	99.9	102.9 100.7 103.0 101.2 101.9
Zähler:	41	19 0 0 0 0 0 0 0 0
Innenzehner:	34	
weiteste:	469 (44), 386 (60), 347 (2)	
beste Teiler	37.3 (45.)	68.9 (54.) 78.1 (59.)
Trefferlage	0.27 mm links, 0.08 mm hoch	
Streuwert	1.52, horizontal: 1.70, vertikal: 1.31	

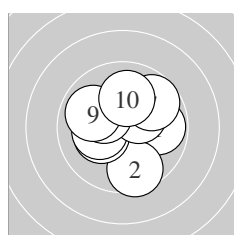

Serie 1:	9.8 →	9.6 ↓	10.0 ↖	10.2 *	10.2 *
	10.3 *	9.7 ↗	10.2 *	9.9 ↖	10.0 ↑
beste Teiler	159.6 (6.) 176.7 (8.) 181.4 (4.)				
Trefferlage	0.17 mm links, 0.39 mm hoch				
Streuwert	1.79, horizontal: 1.96, vertikal: 1.61				

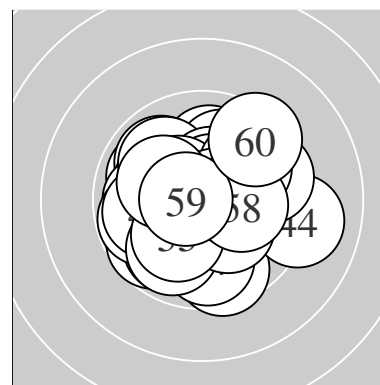
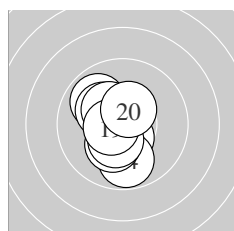

Serie 2:	9.9 ↖	10.5 *	10.6 *	9.8 ↓	10.2 *
	10.2 *	10.3 *	10.4 *	10.6 *	10.4 *
beste Teiler	90.0 (13.) 94.1 (19.) 111.5 (12.)				
Trefferlage	0.67 mm links, 0.17 mm tief				
Streuwert	1.21, horizontal: 0.81, vertikal: 1.50				

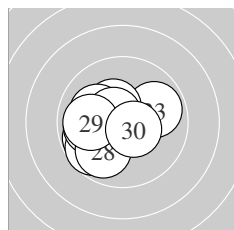

Serie 3:	9.8 ↙	9.7 ↙	9.9 ↗	10.4 *	10.1 ↖
	10.6 *	9.9 ←	9.9 ↙	9.9 ←	10.5 *
beste Teiler	90.0 (26.) 104.8 (30.) 142.3 (24.)				
Trefferlage	1.16 mm links, 0.29 mm tief				
Streuwert	1.49, horizontal: 1.70, vertikal: 1.23				

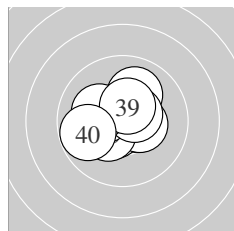

Serie 4:	10.5 *	10.0 ↑	10.5 *	10.4 *	10.4 *
	10.3 *	10.5 *	10.2 *	10.4 *	9.8 ←
beste Teiler	102.7 (33.) 110.1 (37.) 124.9 (31.)				
Trefferlage	0.30 mm links, 0.18 mm hoch				
Streuwert	1.26, horizontal: 1.47, vertikal: 1.01				

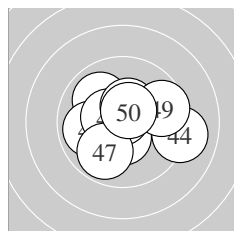

Serie 5:	10.5 *	10.0 ↖	9.9 ←	9.1 →	10.8 *
	10.5 *	9.9 ↙	10.4 *	9.6 →	10.5 *
beste Teiler	37.3 (45.) 103.7 (50.) 119.2 (46.)				
Trefferlage	0.17 mm rechts, 0.06 mm hoch				
Streuwert	1.81, horizontal: 2.21, vertikal: 1.30				

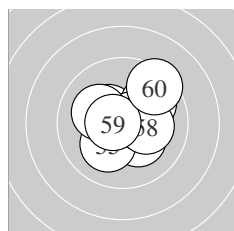

Serie 6:	10.4 *	10.2 *	9.9 ↗	10.7 *	10.1 ↙
	10.1 ↖	10.3 *	10.2 *	10.6 *	9.4 ↗
beste Teiler	68.9 (54.) 78.1 (59.) 140.8 (51.)				
Trefferlage	0.50 mm rechts, 0.32 mm hoch				
Streuwert	1.47, horizontal: 1.60, vertikal: 1.32				

Meyton Elektronik

LG 60 ZR – Wertung – Juniorinnen

StandNr: 111

Wachtler,, Manuela #70804069

StartNr: 11

13. Januar 2019 13:22

SG_Fügenberg

Unterschrift des Schützen

Meyton Elektronik

Ergebnis:	549.5	(523)
Serien:	94.4 89.8 94.3 90.0 91.1 89.9	
Zähler:	15 20 18 7 0 0 0 0 0 0	
Innenzehner:	7	
weiteste:	993 (18), 989 (35), 826 (32)	
beste Teiler	20.5 (5.) 28.0 (30.) 102.7 (3.)	
Trefferlage	1.36 mm links, 0.05 mm tief	
Streuwert	3.47, horizontal: 4.33, vertikal: 2.31	

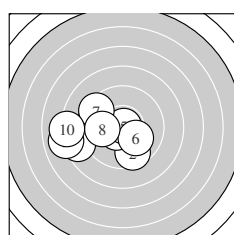
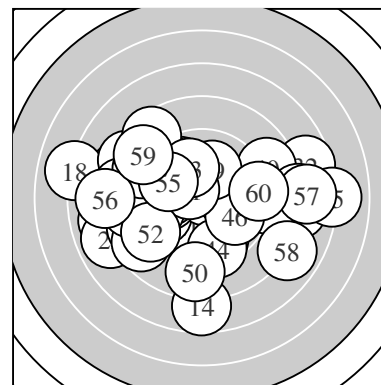

Serie 1:	9.4 ←	9.6 ↓	10.5 *	8.5 ←	10.9 *
	10.1 ↘	9.4 ↖	9.9 ←	8.0 ←	8.1 ←
beste Teiler	20.5 (5.)	102.7 (3.)	216.0 (6.)		
Trefferlage	2.73 mm links, 0.70 mm tief				
Streuwert	2.54, horizontal: 3.27, vertikal: 1.47				

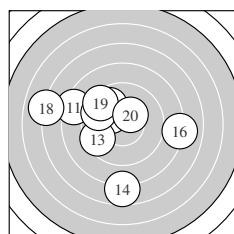

Serie 2:	8.3 ↖	10.2 *	9.5 ↙	7.7 ↓	9.8 ↗
	8.0 →	9.6 ↖	7.0 ←	9.4 ↘	10.3 *
beste Teiler	154.6 (20.)	178.8 (12.)	290.6 (15.)		
Trefferlage	1.98 mm links, 0.20 mm hoch				
Streuwert	3.92, horizontal: 4.46, vertikal: 3.29				

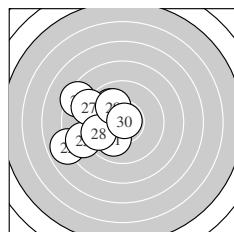

Serie 3:	10.0 ↓	7.9 ←	9.7 ↖	8.4 ↖	8.8 ←
	10.0 ↘	9.1 ↖	9.6 ←	10.0 ↗	10.8 *
beste Teiler	28.0 (30.)	232.3 (29.)	236.3 (21.)		
Trefferlage	3.15 mm links, 0.08 mm hoch				
Streuwert	2.22, horizontal: 2.30, vertikal: 2.13				

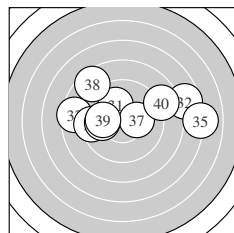

Serie 4:	10.1 ↗	7.6 →	8.5 ←	9.4 ←	7.0 →
	9.9 ←	10.2 *	8.5 ↘	10.0 ←	8.8 →
beste Teiler	179.5 (37.)	222.5 (31.)	249.4 (39.)		
Trefferlage	0.45 mm rechts, 1.21 mm hoch				
Streuwert	4.02, horizontal: 5.44, vertikal: 1.64				

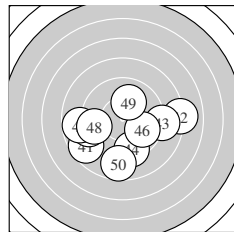

Serie 5:	8.7 ↙	8.0 →	8.9 →	9.4 ↓	9.2 ←
	9.8 ↘	8.8 ←	9.5 ←	10.1 ↑	8.7 ↓
beste Teiler	225.5 (49.)	283.1 (46.)	371.1 (48.)		
Trefferlage	0.17 mm links, 1.51 mm tief				
Streuwert	3.44, horizontal: 4.33, vertikal: 2.22				

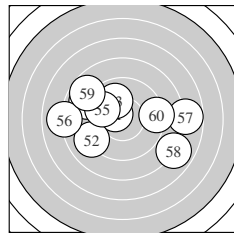

Serie 6:	10.5 *	9.1 ↙	10.0 ↗	8.9 ↖	9.8 ↖
	8.0 ←	7.8 →	7.9 ↘	8.7 ↖	9.2 →
beste Teiler	113.1 (51.)	247.0 (53.)	285.3 (55.)		
Trefferlage	0.60 mm links, 0.38 mm hoch				
Streuwert	3.98, horizontal: 5.16, vertikal: 2.23				

Meyton Elektronik

LG 60 ZR – Wertung – Junioren

StandNr: 112

Brandstätter, Manuel #70425161

StartNr: 12

13. Januar 2019 13:38

SG_Wörgl

Unterschrift des Schützen

Meyton Elektronik

Ergebnis:	559.3	(531)
Serien:	91.4 91.4 92.7 94.0 93.0 96.8	
Zähler:	17 22 16 5 0 0 0 0 0 0	
Innenzehner:	14	
weiteste:	967 (37), 872 (42), 863 (21)	
beste Teiler	39.0 (52.) 85.1 (3.) 106.0 (18.)	
Trefferlage	0.17 mm rechts, 0.20 mm hoch	
Streuwert	3.33, horizontal: 3.81, vertikal: 2.76	

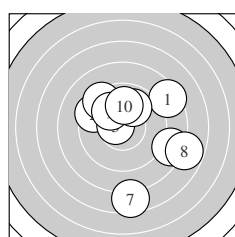
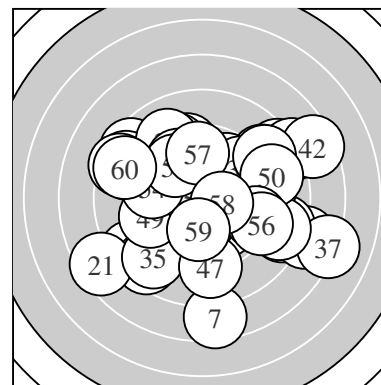

Serie 1:

8.4 ↗	9.4 ↖	10.6 *	9.9 ↗	9.4 ↖
8.5 ↘	7.5 ↓	7.8 ↘	10.0 ↖	9.9 ↑
beste Teiler	85.1 (3.)	239.0 (9.)	259.6 (10.)	
Trefferlage	1.25 mm rechts, 0.14 mm hoch			
Streuwert	3.72, horizontal: 3.70, vertikal: 3.73			

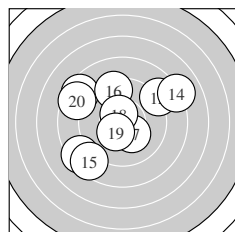

Serie 2:

8.4 ↙	8.9 ↗	8.5 ↖	8.0 ↗	8.5 ↙
9.4 ↑	10.2 *	10.5 *	10.4 *	8.6 ↖
beste Teiler	106.0 (18.)	143.4 (19.)	177.2 (17.)	
Trefferlage	1.01 mm links, 0.61 mm hoch			
Streuwert	3.65, horizontal: 4.07, vertikal: 3.18			

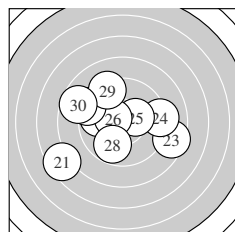

Serie 3:

7.5 ↙	9.8 ↖	8.5 ↘	9.2 →	10.3 *
10.5 *	9.1 ↖	9.8 ↓	9.3 ↖	8.7 ↖
beste Teiler	122.9 (26.)	163.2 (25.)	289.9 (28.)	
Trefferlage	1.19 mm links, 0.04 mm hoch			
Streuwert	3.43, horizontal: 4.14, vertikal: 2.51			

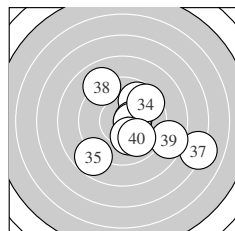

Serie 4:

9.8 ↗	10.5 *	10.5 *	9.6 ↗	8.8 ↙
10.2 *	7.1 ↘	9.0 ↖	8.6 ↘	9.9 ↘
beste Teiler	113.2 (33.)	125.0 (32.)	194.8 (36.)	
Trefferlage	1.78 mm rechts, 0.49 mm tief			
Streuwert	3.18, horizontal: 3.57, vertikal: 2.73			

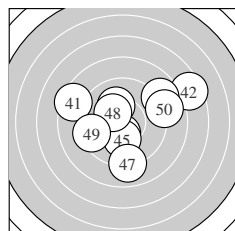

Serie 5:

8.4 ↖	7.5 ↗	8.8 ↗	10.4 *	10.2 *
10.1 ↖	9.0 ↓	10.3 *	9.4 ↙	8.9 →
beste Teiler	133.4 (44.)	161.2 (48.)	200.0 (45.)	
Trefferlage	0.62 mm rechts, 0.40 mm hoch			
Streuwert	3.49, horizontal: 4.14, vertikal: 2.69			

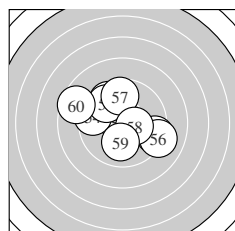

Serie 6:

9.3 ↘	10.8 *	9.7 ↖	9.5 ↖	9.7 ↖
9.1 ↘	9.7 ↑	10.4 *	10.0 ↓	8.6 ↖
beste Teiler	39.0 (52.)	145.7 (58.)	228.4 (59.)	
Trefferlage	0.42 mm links, 0.51 mm hoch			
Streuwert	2.58, horizontal: 3.04, vertikal: 2.01			

Meyton Elektronik

LG 60 ZR – Wertung – Junioren

StandNr: 113

Bindhammer,, Alexander #70420027

StartNr: 13

13. Januar 2019 13:50

SG_Söller_Sportschützen

Unterschrift des Schützen

Meyton Elektronik

Ergebnis: **396.4** (375)
 Serien: 99.7 96.4 102.8 97.5
 Zähler: 20 15 5 0 0 0 0 0 0 0
 Innenzehner: 17
 weiteste: 715 (17), 665 (32), 629 (40)
 beste Teiler 43.8 (4.) 48.1 (23.) 52.4 (24.)
 Trefferlage 0.64 mm links, 0.32 mm tief
 Streuwert 2.20, horizontal: 2.90, vertikal: 1.12

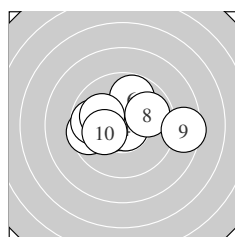
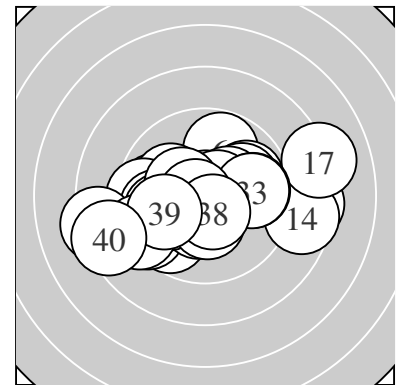

Serie 1:
 10.4 * 10.6 * 9.6 ← 10.8 * 9.8 ←
 9.8 ↑ 10.1 ↖ 9.9 → 8.5 → 10.2 *
 beste Teiler 43.8 (4.) 94.9 (2.) 141.6 (1.)
 Trefferlage 0.26 mm links, 0.20 mm hoch
 Streuwert 2.17, horizontal: 2.86, vertikal: 1.09

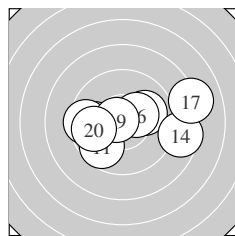

Serie 2:
 9.7 ↙ 9.9 ← 10.0 → 8.6 → 9.8 ←
 10.3 * 8.1 → 9.5 ← 10.7 * 9.8 ←
 beste Teiler 64.8 (19.) 155.6 (16.) 239.3 (13.)
 Trefferlage 0.14 mm rechts, 0.07 mm tief
 Streuwert 2.81, horizontal: 3.77, vertikal: 1.23

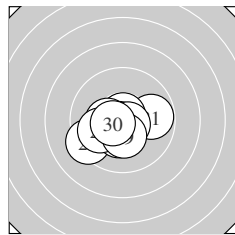

Serie 3:
 9.8 → 9.3 ↙ 10.8 * 10.7 * 10.3 *
 10.4 * 10.0 ← 10.7 * 10.3 * 10.5 *
 beste Teiler 48.1 (23.) 52.4 (24.) 67.4 (28.)
 Trefferlage 0.53 mm links, 0.66 mm tief
 Streuwert 1.35, horizontal: 1.70, vertikal: 0.87

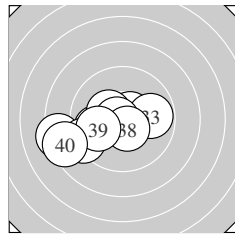

Serie 4:
 10.6 * 8.3 ← 9.8 → 9.8 ← 10.3 *
 9.2 ↙ 10.7 * 10.5 * 9.9 ← 8.4 ←
 beste Teiler 58.1 (37.) 89.5 (31.) 106.4 (38.)
 Trefferlage 1.91 mm links, 0.77 mm tief
 Streuwert 2.21, horizontal: 2.92, vertikal: 1.12

Unterschrift des Schützen

Meyton Elektronik

Ergebnis: **386.6** (370)
 Serien: 96.8 97.2 94.2 98.4
 Zähler: 17 16 7 0 0 0 0 0 0 0
 Innenzehner: 13
 weiteste: 648 (5), 628 (21), 586 (6)
 beste Teiler 4.4 (4.) 54.7 (14.) 93.1 (12.)
 Trefferlage 0.20 mm links, 0.71 mm tief
 Streuwert 2.54, horizontal: 2.85, vertikal: 2.18

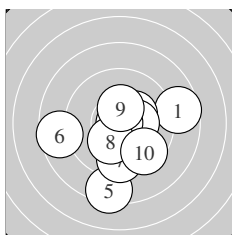
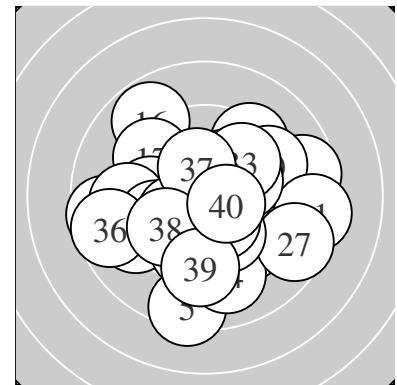

Serie 1:
 8.6 → 10.3 * 10.3 * 10.9 * 8.4 ↓
 8.6 ← 9.6 ↓ 10.2 * 10.4 * 9.5 ↘
 beste Teiler 4.4 (4.) 145.3 (9.) 157.0 (3.)
 Trefferlage 0.34 mm rechts, 1.16 mm tief
 Streuwert 2.69, horizontal: 2.89, vertikal: 2.47

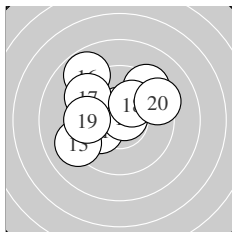

Serie 2:
 10.1 ↙ 10.6 * 9.1 ↙ 10.7 * 9.3 ↗
 8.8 ↘ 9.4 ↘ 10.2 * 9.7 ← 9.3 →
 beste Teiler 54.7 (14.) 93.1 (12.) 198.0 (18.)
 Trefferlage 0.73 mm links, 1.11 mm hoch
 Streuwert 2.33, horizontal: 2.68, vertikal: 1.93

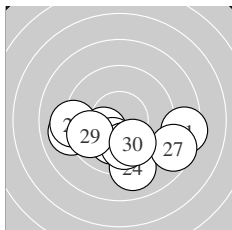

Serie 3:
 8.4 → 9.0 ← 10.2 * 9.1 ↓ 10.1 ↓
 9.2 ← 8.6 ↘ 9.9 ↓ 9.7 ← 10.0 ↓
 beste Teiler 184.4 (23.) 210.9 (25.) 250.4 (30.)
 Trefferlage 0.01 mm rechts, 1.86 mm tief
 Streuwert 2.72, horizontal: 3.66, vertikal: 1.19

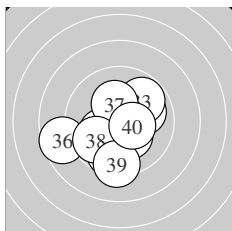

Serie 4:
 10.2 * 10.0 → 9.8 ↗ 9.7 ↓ 10.3 *
 8.6 ← 10.3 * 9.8 ↙ 9.3 ↓ 10.4 *
 beste Teiler 130.0 (40.) 170.2 (35.) 172.8 (37.)
 Trefferlage 0.45 mm links, 0.92 mm tief
 Streuwert 2.16, horizontal: 2.33, vertikal: 1.98

Unterschrift des Schützen

Ergebnis: **411.1** (395)
 Serien: 102.8 102.9 103.9 101.5
 Zähler: 35 5 0 0 0 0 0 0 0 0
 Innenzehner: 28
 weiteste: 460 (6), 417 (18), 373 (35)
 beste Teiler 11.4 (29.) 31.7 (21.) 55.3 (3.)
 Trefferlage 0.25 mm links, 0.08 mm hoch
 Streuwert 1.40, horizontal: 1.59, vertikal: 1.18

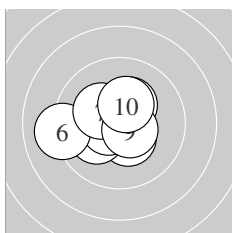
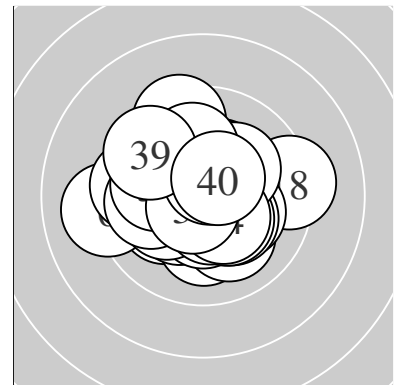

Serie 1:
 10.4 * 10.1 ↙ 10.7 * 10.5 * 10.6 *
 9.1 ← 10.2 * 10.3 * 10.6 * 10.3 *
 beste Teiler 55.3 (3.) 93.3 (5.) 97.0 (9.)
 Trefferlage 0.73 mm links, 0.13 mm hoch
 Streuwert 1.37, horizontal: 1.66, vertikal: 1.01

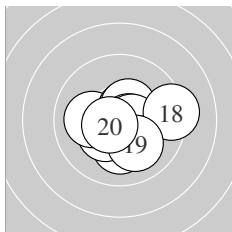

Serie 2:
 10.1 ↓ 10.3 * 10.1 ← 10.6 * 10.5 *
 10.7 * 10.6 * 9.3 → 10.1 ↘ 10.6 *
 beste Teiler 72.3 (16.) 87.6 (20.) 97.4 (17.)
 Trefferlage 0.41 mm rechts, 0.30 mm tief
 Streuwert 1.41, horizontal: 1.69, vertikal: 1.07

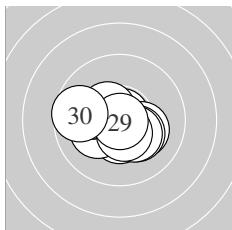

Serie 3:
 10.8 * 10.2 * 10.3 * 10.5 * 10.5 *
 10.2 * 10.3 * 10.5 * 10.9 * 9.7 ←
 beste Teiler 11.4 (29.) 31.7 (21.) 110.3 (28.)
 Trefferlage 0.11 mm links, 0.45 mm tief
 Streuwert 1.19, horizontal: 1.50, vertikal: 0.76

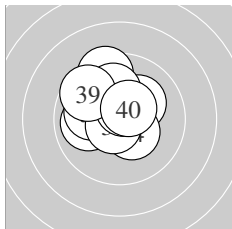

Serie 4:
 10.0 ← 10.0 ← 10.2 * 10.4 * 9.5 ↑
 10.7 * 10.6 * 10.0 ↑ 9.6 ↘ 10.5 *
 beste Teiler 71.4 (36.) 92.6 (37.) 111.3 (40.)
 Trefferlage 0.58 mm links, 0.95 mm hoch
 Streuwert 1.44, horizontal: 1.47, vertikal: 1.39

Unterschrift des Schützen

Meyton Elektronik

Ergebnis: **378.5** (360)
 Serien: 98.1 89.7 93.8 96.9
 Zähler: 13 18 5 4 0 0 0 0 0 0
 Innenzehner: 8
 weiteste: 948 (17), 897 (19), 775 (20)
 beste Teiler 78.5 (39.) 86.4 (1.) 90.4 (33.)
 Trefferlage 1.46 mm links, 0.27 mm hoch
 Streuwert 2.92, horizontal: 3.69, vertikal: 1.85

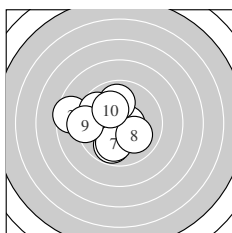
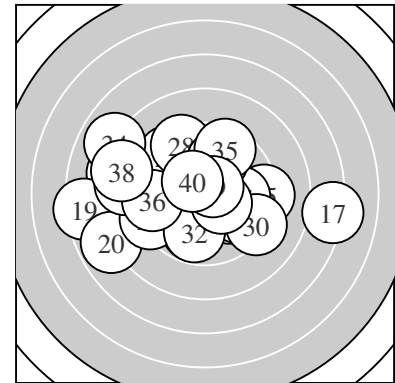

Serie 1:
 10.6 * 10.2 * 8.5 ← 9.9 ↑ 9.8 ↓
 9.7 ↖ 10.0 ↓ 10.0 ↘ 9.3 ← 10.1 ↘
 beste Teiler 86.4 (1.) 183.0 (2.) 202.4 (10.)
 Trefferlage 1.52 mm links, 0.01 mm hoch
 Streuwert 2.04, horizontal: 2.30, vertikal: 1.75

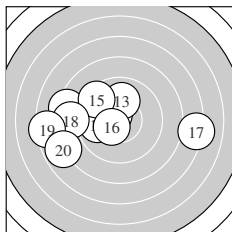

Serie 2:
 10.6 * 8.3 ← 10.0 ↑ 9.9 ← 9.4 ↘
 10.4 * 7.2 → 8.6 ← 7.4 ← 7.9 ←
 beste Teiler 94.9 (11.) 127.6 (16.) 237.3 (13.)
 Trefferlage 2.58 mm links, 0.03 mm tief
 Streuwert 3.90, horizontal: 5.19, vertikal: 1.87

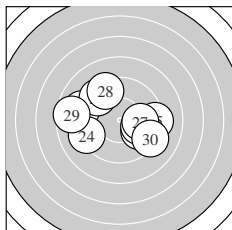

Serie 3:
 9.9 ↘ 10.0 → 9.0 ← 9.2 ← 9.2 →
 9.4 ↘ 9.9 → 9.4 ↘ 8.6 ← 9.2 ↘
 beste Teiler 249.8 (22.) 254.8 (27.) 274.9 (21.)
 Trefferlage 0.35 mm links, 0.18 mm hoch
 Streuwert 3.03, horizontal: 3.83, vertikal: 1.92

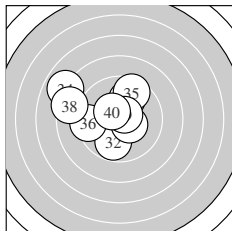

Serie 4:
 9.9 ↑ 9.8 ↓ 10.6 * 7.9 ↖ 9.5 ↑
 9.4 ← 10.4 * 8.4 ← 10.6 * 10.4 *
 beste Teiler 78.5 (39.) 90.4 (33.) 131.5 (40.)
 Trefferlage 1.40 mm links, 0.95 mm hoch
 Streuwert 2.56, horizontal: 3.04, vertikal: 1.96

Unterschrift des Schützen

Meyton Elektronik

Ergebnis: **386.6** (367)
 Serien: 95.3 98.8 96.6 95.9
 Zähler: 13 21 6 0 0 0 0 0 0 0
 Innenzehner: 9
 weiteste: 604 (1), 574 (20), 563 (39)
 beste Teiler 51.1 (23.) 76.4 (18.) 81.8 (16.)
 Trefferlage 0.91 mm links, 0.79 mm hoch
 Streuwert 2.39, horizontal: 2.55, vertikal: 2.21

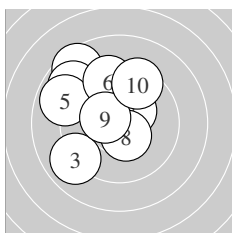
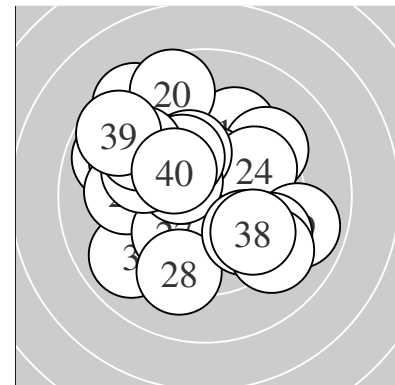

Serie 1:
 8.5 ↘ 8.9 ↘ 9.0 ↙ 9.9 ↘ 8.9 ↘
 9.4 ↑ 10.4 * 10.5 * 10.4 * 9.4 ↑
 beste Teiler 122.5 (8.) 136.1 (9.) 148.5 (7.)
 Trefferlage 1.73 mm links, 1.64 mm hoch
 Streuwert 2.36, horizontal: 2.31, vertikal: 2.41

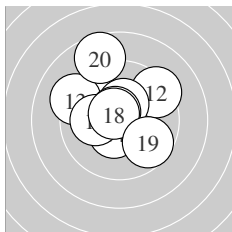

Serie 2:
 9.7 ↘ 9.3 ↗ 9.2 ↘ 10.5 * 10.4 *
 10.6 * 10.1 ← 10.6 * 9.7 ↘ 8.7 ↑
 beste Teiler 76.4 (18.) 81.8 (16.) 121.3 (14.)
 Trefferlage 0.54 mm links, 1.14 mm hoch
 Streuwert 2.12, horizontal: 2.17, vertikal: 2.06

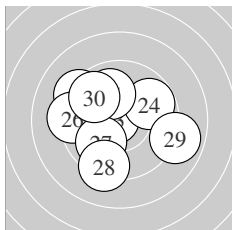

Serie 3:
 9.7 ← 9.3 ↘ 10.7 * 9.8 ↗ 10.0 ↑
 9.3 ← 9.9 ↙ 9.3 ↓ 8.9 → 9.7 ↘
 beste Teiler 51.1 (23.) 242.9 (25.) 251.8 (27.)
 Trefferlage 0.99 mm links, 0.14 mm hoch
 Streuwert 2.47, horizontal: 2.81, vertikal: 2.08

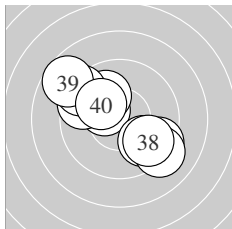

Serie 4:
 10.3 * 9.4 ↘ 9.5 ↘ 10.0 ↘ 9.3 ↘
 9.8 ↘ 9.1 ↘ 9.7 ↘ 8.7 ↘ 10.1 ↘
 beste Teiler 151.9 (31.) 209.7 (40.) 237.1 (34.)
 Trefferlage 0.38 mm links, 0.25 mm hoch
 Streuwert 2.66, horizontal: 3.02, vertikal: 2.23

Unterschrift des Schützen

Meyton Elektronik

Ergebnis: **385.5** (366)
 Serien: 97.4 95.7 97.2 95.2
 Zähler: 13 20 7 0 0 0 0 0 0 0
 Innenzehner: 11
 weiteste: 695 (38), 670 (26), 649 (22)
 beste Teiler 57.0 (27.) 57.7 (39.) 60.0 (9.)
 Trefferlage 1.51 mm links, 0.43 mm tief
 Streuwert 2.44, horizontal: 2.79, vertikal: 2.03

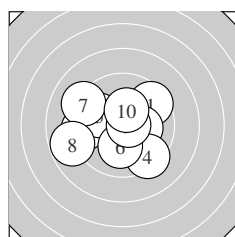
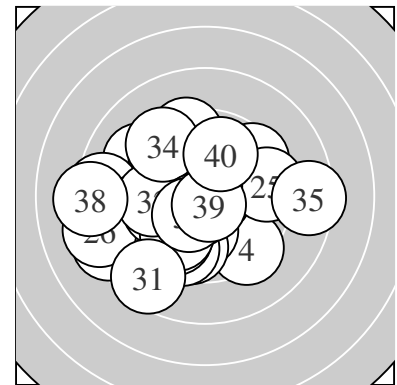

Serie 1:
 9.5 ↗ 9.4 ← 10.2 * 9.3 ↘ 9.9 ↖
 10.1 ↓ 9.2 ↖ 8.8 ← 10.7 * 10.3 *
 beste Teiler 60.0 (9.) 156.9 (10.) 185.1 (3.)
 Trefferlage 0.73 mm links, 0.09 mm tief
 Streuwert 2.43, horizontal: 2.89, vertikal: 1.84

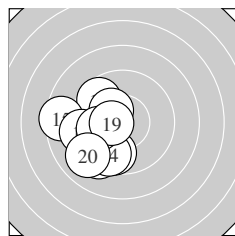

Serie 2:
 9.7 ↓ 9.3 ↙ 9.6 ↘ 9.6 ↓ 8.5 ←
 10.3 * 9.3 ← 9.9 ← 10.5 * 9.0 ↙
 beste Teiler 112.4 (19.) 164.7 (16.) 251.8 (18.)
 Trefferlage 2.55 mm links, 1.10 mm tief
 Streuwert 1.89, horizontal: 1.67, vertikal: 2.08

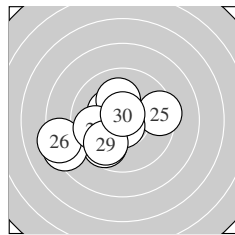

Serie 3:
 9.7 ↙ 8.4 ← 10.3 * 10.1 ↑ 9.4 →
 8.3 ← 10.7 * 9.8 ← 9.8 ↙ 10.7 *
 beste Teiler 57.0 (27.) 61.0 (30.) 157.3 (23.)
 Trefferlage 1.64 mm links, 0.70 mm tief
 Streuwert 2.39, horizontal: 2.93, vertikal: 1.70

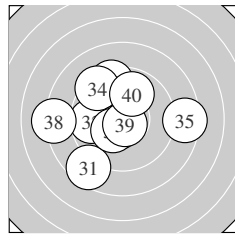

Serie 4:
 8.6 ↙ 9.7 ← 9.4 ↑ 9.3 ↘ 8.4 →
 10.6 * 10.4 * 8.2 ← 10.7 * 9.9 ↑
 beste Teiler 57.7 (39.) 95.7 (36.) 150.4 (37.)
 Trefferlage 1.12 mm links, 0.14 mm hoch
 Streuwert 3.01, horizontal: 3.45, vertikal: 2.49

Unterschrift des Schützen

Meyton Elektronik

Ergebnis: **410.0** (397)^{MAN}
 Serien: 103.1 100.2 103.7 103.0
 Zähler: 37 3 0 0 0 0 0 0 0 0
 Innenzehner: 27
 weiteste: 401 (20), 376 (40), 351 (10)
 beste Teiler 126.0 (1.) 126.0 (2.) 126.0 (3.)
 Trefferlage 1.63 mm rechts, 0.00 mm
 Streuwert 0.49, horizontal: 0.70, vertikal: 0.00

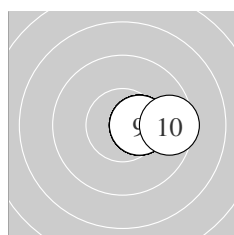
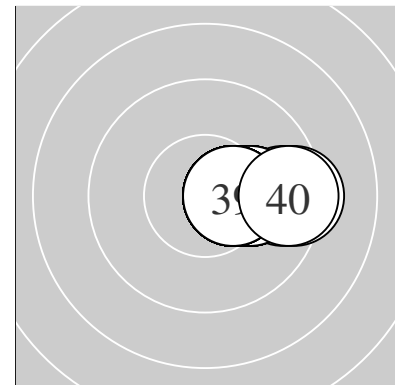

Serie 1:
 10.4 * 10.4 * 10.4 * 10.4 * 10.4 *
 10.4 *^{IBJ} 10.4 *^{IBJ} 10.4 *^{IBJ} 10.4 *^{IBJ} 9.5 →^{IBJ}
 beste Teiler 126.0 (1.) 126.0 (2.) 126.0 (3.)
 Trefferlage 1.48 mm rechts, 0.00 mm
 Streuwert 0.50, horizontal: 0.71, vertikal: 0.00

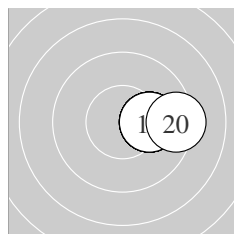

Serie 2:
 10.1 → 10.1 → 10.1 → 10.1 → 10.1 →
 10.1 →^{IBJ} 10.1 →^{IBJ} 10.1 →^{IBJ} 10.1 →^{IBJ} 9.3 →^{IBJ}
 beste Teiler 201.0 (11.) 201.0 (12.) 201.0 (13.)
 Trefferlage 2.21 mm rechts, 0.00 mm
 Streuwert 0.45, horizontal: 0.63, vertikal: 0.00

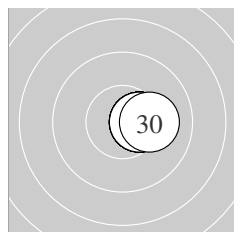

Serie 3:
 10.4 * 10.4 * 10.4 * 10.4 * 10.4 *
 10.4 *^{IBJ} 10.4 *^{IBJ} 10.4 *^{IBJ} 10.4 *^{IBJ} 10.1 →^{IBJ}
 beste Teiler 126.0 (21.) 126.0 (22.) 126.0 (23.)
 Trefferlage 1.33 mm rechts, 0.00 mm
 Streuwert 0.17, horizontal: 0.24, vertikal: 0.00

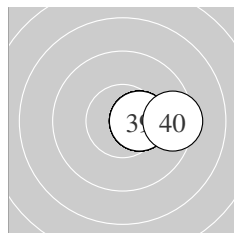

Serie 4:
 10.4 * 10.4 * 10.4 * 10.4 * 10.4 *
 10.4 *^{IBJ} 10.4 *^{IBJ} 10.4 *^{IBJ} 10.4 *^{IBJ} 9.4 →^{IBJ}
 beste Teiler 126.0 (31.) 126.0 (32.) 126.0 (33.)
 Trefferlage 1.51 mm rechts, 0.00 mm
 Streuwert 0.56, horizontal: 0.79, vertikal: 0.00

IBJ – Treffer wurde vom Kampfgericht manuell eingefügt
 MAN – Ergebnis wurde manuell erfasst

Unterschrift des Schützen

Meyton Elektronik

Ergebnis: **351.3** (334)
 Serien: 91.9 85.3 81.1 93.0
 Zähler: 6 15 15 2 0 1 0 0 0 0
 Innenzehner: 5
 weiteste: 2806 (21), 1334 (17), 895 (4)
 beste Teiler 60.4 (24.) 76.4 (33.) 133.0 (6.)
 Trefferlage 0.26 mm links, 1.43 mm hoch
 Streuwert 4.86, horizontal: 3.16, vertikal: 6.10

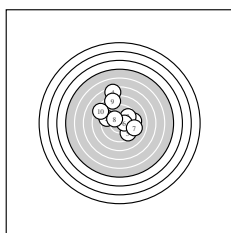
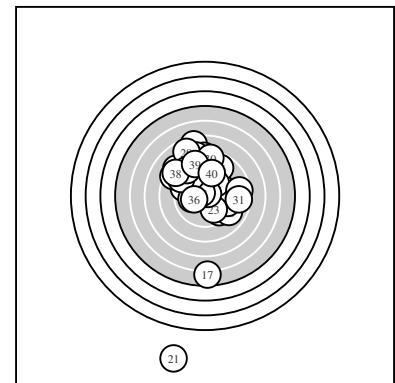

Serie 1:
 9.3 → 9.4 ↖ 9.8 ↗ 7.4 ↑ 9.5 ↘
 10.4 * 9.2 → 10.2 * 8.3 ↑ 8.4 ↖
 beste Teiler 133.0 (6.) 185.1 (8.) 300.8 (3.)
 Trefferlage 0.00 mm , 1.93 mm hoch
 Streuwert 3.36, horizontal: 3.29, vertikal: 3.43

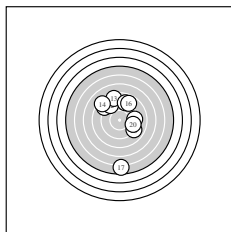

Serie 2:
 8.7 ↖ 9.0 ↖ 8.4 ↑ 8.3 ↖ 8.9 ↑
 8.8 ↗ 5.6 ↓ 9.0 ↘ 9.2 → 9.4 →
 beste Teiler 399.1 (20.) 426.9 (19.) 487.0 (18.)
 Trefferlage 0.32 mm rechts, 1.11 mm hoch
 Streuwert 4.82, horizontal: 3.48, vertikal: 5.87

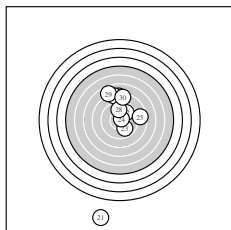

Serie 3:
 0.0 ↓ 9.8 ↗ 9.9 ↘ 10.7 * 8.6 →
 8.2 ↑ 8.1 ↑ 9.8 ↑ 7.7 ↖ 8.3 ↑
 beste Teiler 60.4 (24.) 273.5 (23.) 281.4 (22.)
 Trefferlage 0.00 mm , 0.41 mm hoch
 Streuwert 7.63, horizontal: 3.01, vertikal: 10.37

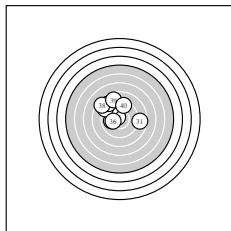

Serie 4:
 8.7 → 10.0 ← 10.6 * 9.3 ↖ 9.0 ↖
 10.2 * 8.8 ↖ 8.4 ↖ 8.7 ↑ 9.3 ↑
 beste Teiler 76.4 (33.) 193.8 (36.) 235.3 (32.)
 Trefferlage 1.40 mm links, 2.25 mm hoch
 Streuwert 2.69, horizontal: 3.03, vertikal: 2.31

Unterschrift des Schützen

Meyton Elektronik

Ergebnis: **378.9** (360)
 Serien: 95.2 95.0 96.7 92.0
 Zähler: 10 23 4 3 0 0 0 0 0 0
 Innenzehner: 6
 weiteste: 879 (6), 835 (32), 789 (36)
 beste Teiler 31.7 (11.) 82.7 (22.) 98.3 (2.)
 Trefferlage 1.14 mm rechts, 1.58 mm hoch
 Streuwert 2.64, horizontal: 3.33, vertikal: 1.70

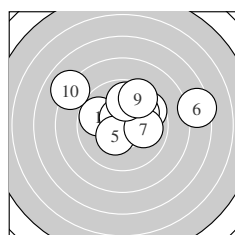
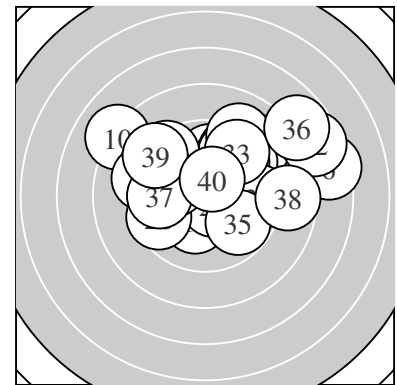

Serie 1:
 9.8 ↖ 10.6 * 9.6 ↗ 10.0 ↗ 10.4 *
 7.4 → 10.0 → 9.9 ↑ 9.5 ↗ 8.0 ↖
 beste Teiler 98.3 (2.) 145.6 (5.) 243.5 (7.)
 Trefferlage 0.78 mm rechts, 1.52 mm hoch
 Streuwert 2.94, horizontal: 3.85, vertikal: 1.57

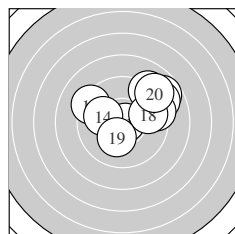

Serie 2:
 10.8 * 8.7 ↗ 9.3 ↖ 10.0 ↖ 9.1 ↗
 8.9 ↗ 9.3 → 9.7 → 10.2 * 9.0 ↗
 beste Teiler 31.7 (11.) 186.8 (19.) 234.6 (14.)
 Trefferlage 1.60 mm rechts, 1.57 mm hoch
 Streuwert 2.41, horizontal: 2.96, vertikal: 1.70

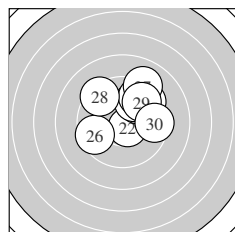

Serie 3:
 9.5 ↗ 10.6 * 9.9 ↗ 9.9 ↗ 9.6 ↗
 9.5 ↖ 9.1 ↗ 9.4 ↖ 9.7 ↗ 9.5 →
 beste Teiler 82.7 (22.) 264.5 (24.) 270.1 (23.)
 Trefferlage 1.05 mm rechts, 1.69 mm hoch
 Streuwert 2.03, horizontal: 2.25, vertikal: 1.79

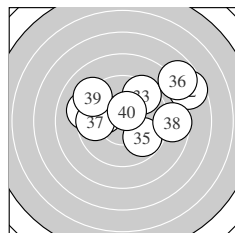

Serie 4:
 10.0 ↖ 7.6 ↗ 9.5 ↗ 9.2 ↖ 9.8 ↖
 7.8 ↗ 9.7 ← 8.7 → 9.2 ↖ 10.5 *
 beste Teiler 125.9 (40.) 231.2 (31.) 292.3 (35.)
 Trefferlage 1.15 mm rechts, 1.53 mm hoch
 Streuwert 3.39, horizontal: 4.36, vertikal: 1.98

Unterschrift des Schützen

Meyton Elektronik

Ergebnis: **404.4** (388)
 Serien: 100.0 100.1 102.9 101.4
 Zähler: 28 12 0 0 0 0 0 0 0 0
 Innenzehner: 23
 weiteste: 486 (38), 453 (14), 422 (10)
 beste Teiler 49.4 (39.) 52.3 (31.) 63.0 (25.)
 Trefferlage 0.34 mm links, 0.44 mm hoch
 Streuwert 1.61, horizontal: 1.81, vertikal: 1.39

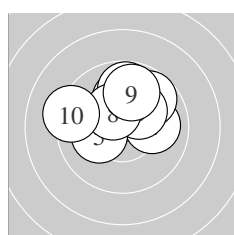
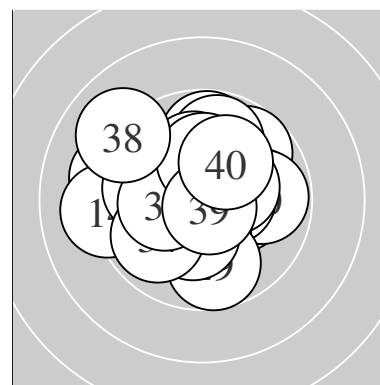

Serie 1:
 10.5 * 10.0 → 9.7 ↗ 10.1 ↑ 10.2 *
 10.2 * 9.8 ↑ 10.4 * 9.8 ↑ 9.3 ←
 beste Teiler 110.0 (1.) 144.5 (8.) 183.1 (6.)
 Trefferlage 0.04 mm links, 1.43 mm hoch
 Streuwert 1.57, horizontal: 1.91, vertikal: 1.13

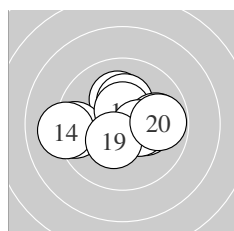

Serie 2:
 10.2 * 10.1 ↑ 9.4 ← 9.1 ← 10.3 *
 10.5 * 9.9 → 10.4 * 10.4 * 9.8 →
 beste Teiler 111.0 (16.) 133.6 (18.) 145.8 (19.)
 Trefferlage 0.07 mm links, 0.24 mm hoch
 Streuwert 1.90, horizontal: 2.47, vertikal: 1.05

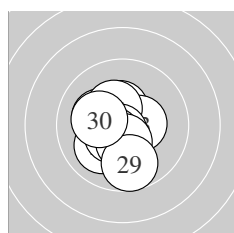

Serie 3:
 10.4 * 10.2 * 10.4 * 10.4 * 10.7 *
 10.0 ↙ 10.5 * 10.4 * 9.7 ↓ 10.2 *
 beste Teiler 63.0 (25.) 113.1 (27.) 128.5 (23.)
 Trefferlage 0.53 mm links, 0.34 mm tief
 Streuwert 1.22, horizontal: 1.03, vertikal: 1.38

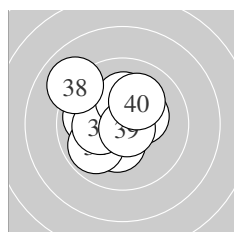

Serie 4:
 10.7 * 10.3 * 9.9 ← 9.9 ↙ 10.3 *
 10.2 * 10.2 * 9.0 ↘ 10.8 * 10.1 ↗
 beste Teiler 49.4 (39.) 52.3 (31.) 157.6 (35.)
 Trefferlage 0.74 mm links, 0.46 mm hoch
 Streuwert 1.61, horizontal: 1.71, vertikal: 1.51

Unterschrift des Schützen

Meyton Elektronik

Ergebnis: **388.7** (371)
 Serien: 96.5 99.2 94.8 98.2
 Zähler: 19 16 3 1 1 0 0 0 0 0
 Innenzehner: 17
 weiteste: 1019 (10), 929 (30), 712 (16)
 beste Teiler 54.4 (18.) 75.1 (1.) 82.0 (40.)
 Trefferlage 0.95 mm links, 0.10 mm hoch
 Streuwert 2.62, horizontal: 3.20, vertikal: 1.88

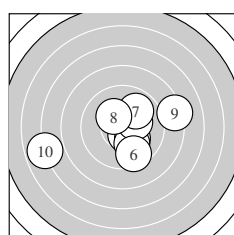
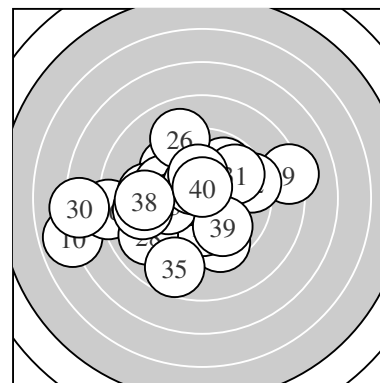

Serie 1:
 10.7 * 10.5 * 10.2 * 10.0 ↘ 10.3 *
 9.5 ↘ 9.9 ↗ 10.3 * 8.2 → 6.9 ←
 beste Teiler 75.1 (1.) 104.5 (2.) 165.4 (5.)
 Trefferlage 0.29 mm rechts, 0.42 mm tief
 Streuwert 3.20, horizontal: 4.06, vertikal: 1.98

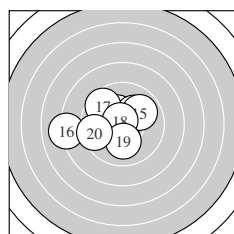

Serie 2:
 10.3 * 10.5 * 10.3 * 10.2 * 9.9 ↗
 8.1 ← 9.6 ↘ 10.7 * 10.1 ↓ 9.5 ←
 beste Teiler 54.4 (18.) 117.8 (12.) 155.9 (11.)
 Trefferlage 1.15 mm links, 0.30 mm hoch
 Streuwert 2.15, horizontal: 2.65, vertikal: 1.49

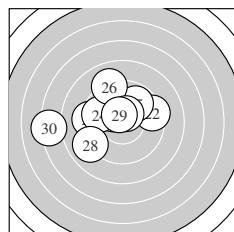

Serie 3:
 9.3 ← 9.4 → 10.3 * 9.7 ↖ 9.8 ↗
 9.0 ↘ 10.5 * 9.0 ↙ 10.6 * 7.2 ←
 beste Teiler 100.7 (29.) 114.3 (27.) 155.8 (23.)
 Trefferlage 1.78 mm links, 0.87 mm hoch
 Streuwert 2.87, horizontal: 3.61, vertikal: 1.87

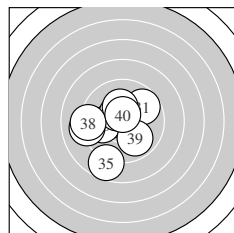

Serie 4:
 9.7 ↗ 10.4 * 9.9 ← 10.5 * 8.7 ↘
 9.1 ← 10.2 * 9.2 ← 9.9 ↘ 10.6 *
 beste Teiler 82.0 (40.) 122.3 (34.) 131.7 (32.)
 Trefferlage 1.16 mm links, 0.33 mm tief
 Streuwert 2.19, horizontal: 2.28, vertikal: 2.10

Unterschrift des Schützen

Meyton Elektronik

Ergebnis: **394.2** (379)
 Serien: 99.1 101.4 97.3 96.4
 Zähler: 21 17 2 0 0 0 0 0 0 0
 Innenzehner: 16
 weiteste: 605 (35), 528 (29), 457 (23)
 beste Teiler 74.3 (27.) 81.0 (21.) 105.7 (12.)
 Trefferlage 0.02 mm rechts, 0.79 mm hoch
 Streuwert 2.14, horizontal: 2.52, vertikal: 1.67

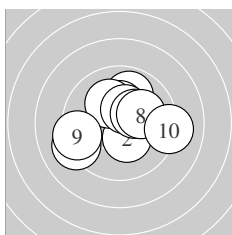
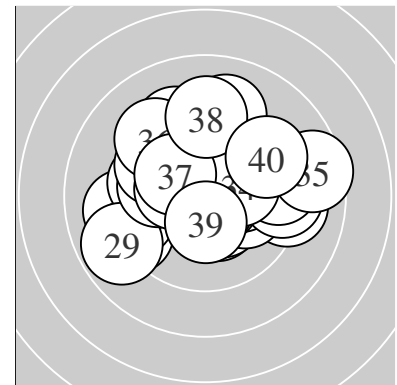

Serie 1:
 9.2 ↙ 10.4 * 9.9 ↑ 10.3 * 10.1 ↖
 10.4 * 10.3 * 10.1 → 9.3 ↙ 9.1 →
 beste Teiler 137.4 (6.) 149.8 (2.) 163.4 (7.)
 Trefferlage 0.10 mm rechts, 0.39 mm hoch
 Streuwert 2.12, horizontal: 2.57, vertikal: 1.54

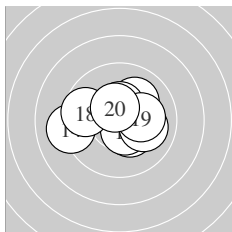

Serie 2:
 10.1 ↗ 10.5 * 10.4 * 9.1 ↙ 10.5 *
 10.4 * 10.0 → 9.7 ↙ 10.2 * 10.5 *
 beste Teiler 105.7 (12.) 107.3 (15.) 122.7 (20.)
 Trefferlage 0.00 mm , 0.20 mm hoch
 Streuwert 1.70, horizontal: 2.18, vertikal: 1.02

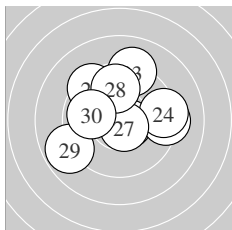

Serie 3:
 10.6 * 9.3 → 9.1 ↑ 9.3 → 9.4 ↖
 10.4 * 10.7 * 9.8 ↑ 8.8 ↙ 9.9 ↙
 beste Teiler 74.3 (27.) 81.0 (21.) 143.2 (26.)
 Trefferlage 0.06 mm links, 0.86 mm hoch
 Streuwert 2.47, horizontal: 2.83, vertikal: 2.05

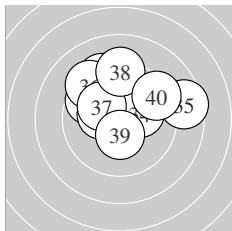

Serie 4:
 9.3 ↖ 9.7 ↖ 10.3 * 10.2 * 8.5 →
 9.3 ↖ 10.1 ↖ 9.2 ↑ 10.4 * 9.4 ↗
 beste Teiler 145.0 (39.) 169.5 (33.) 194.2 (34.)
 Trefferlage 0.08 mm rechts, 1.71 mm hoch
 Streuwert 2.35, horizontal: 2.84, vertikal: 1.73

Unterschrift des Schützen

Ergebnis: **375.9** (358)
 Serien: 92.7 95.0 93.7 94.5
 Zähler: 10 22 5 2 1 0 0 0 0 0
 Innenzehner: 5
 weiteste: 1135 (30), 908 (39), 830 (2)
 beste Teiler 63.1 (31.) 116.4 (37.) 150.0 (15.)
 Trefferlage 0.46 mm rechts, 0.23 mm hoch
 Streuwert 3.16, horizontal: 3.49, vertikal: 2.79

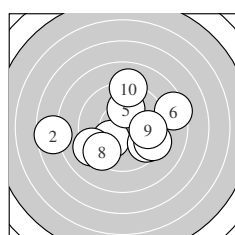
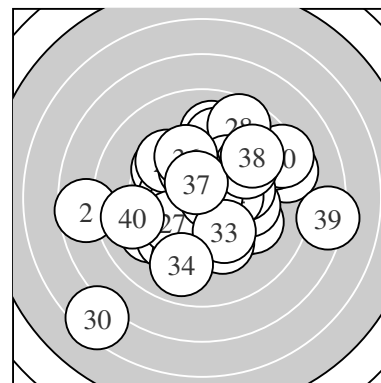

Serie 1:
 10.2 * 7.6 ← 9.6 ↘ 9.4 ↘ 10.1 ↑
 8.4 → 9.2 ↙ 9.4 ↙ 9.7 → 9.1 ↑
 beste Teiler 200.1 (1.) 220.6 (5.) 303.3 (9.)
 Trefferlage 0.07 mm rechts, 0.27 mm tief
 Streuwert 3.41, horizontal: 4.17, vertikal: 2.42

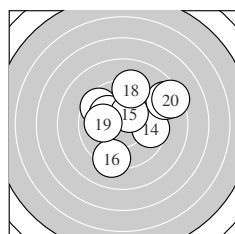

Serie 2:
 9.8 ↗ 9.6 ↖ 10.1 ↖ 9.6 → 10.4 *
 9.2 ↓ 8.7 → 9.2 ↑ 10.0 ← 8.4 →
 beste Teiler 150.0 (15.) 208.5 (13.) 232.3 (19.)
 Trefferlage 0.98 mm rechts, 1.19 mm hoch
 Streuwert 2.70, horizontal: 3.04, vertikal: 2.30

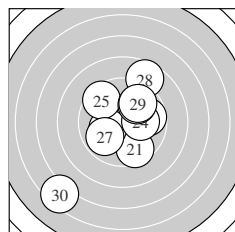

Serie 3:
 9.6 ↘ 10.2 * 9.7 → 10.1 → 9.5 ↖
 9.9 ↗ 9.9 ↙ 8.6 ↑ 9.8 ↗ 6.4 ↙
 beste Teiler 189.2 (22.) 213.1 (24.) 265.5 (26.)
 Trefferlage 0.11 mm links, 0.14 mm tief
 Streuwert 3.55, horizontal: 3.30, vertikal: 3.79

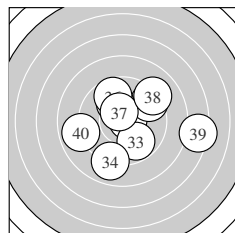

Serie 4:
 10.7 * 9.4 ↗ 9.8 ↘ 9.0 ↓ 10.1 ↖
 9.7 ↖ 10.5 * 9.1 ↗ 7.3 → 8.9 ←
 beste Teiler 63.1 (31.) 116.4 (37.) 224.5 (35.)
 Trefferlage 0.90 mm rechts, 0.14 mm hoch
 Streuwert 3.22, horizontal: 3.76, vertikal: 2.58

Unterschrift des Schützen

Meyton Elektronik

Ergebnis: **383.1** (363)
 Serien: 99.1 97.0 93.4 93.6
 Zähler: 12 23 3 0 2 0 0 0 0 0
 Innenzehner: 12
 weiteste: 1184 (29), 1068 (34), 565 (20)
 beste Teiler 49.6 (5.) 75.0 (33.) 78.8 (22.)
 Trefferlage 0.78 mm links, 1.41 mm hoch
 Streuwert 2.72, horizontal: 3.34, vertikal: 1.91

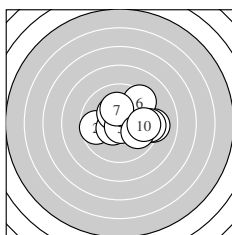
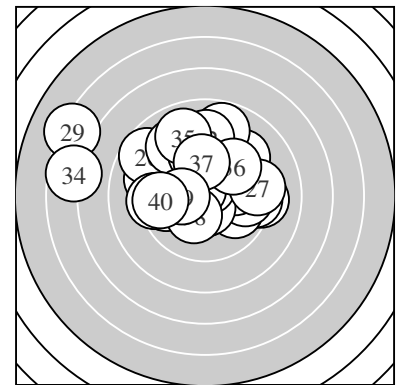

Serie 1:
 9.2 → 9.7 ← 10.5 * 10.3 * 10.8 *
 9.4 ↗ 10.2 * 9.4 → 9.9 ↘ 9.7 →
 beste Teiler 49.6 (5.) 113.0 (3.) 155.7 (4.)
 Trefferlage 1.17 mm rechts, 0.24 mm hoch
 Streuwert 2.00, horizontal: 2.51, vertikal: 1.31

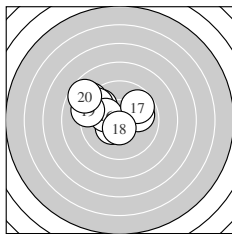

Serie 2:
 9.7 ↖ 9.9 → 9.1 ↖ 10.4 * 9.5 ↖
 10.2 * 9.8 ↗ 10.5 * 9.2 ↖ 8.7 ↖
 beste Teiler 105.1 (18.) 141.4 (14.) 197.6 (16.)
 Trefferlage 1.65 mm links, 1.24 mm hoch
 Streuwert 2.08, horizontal: 2.58, vertikal: 1.43

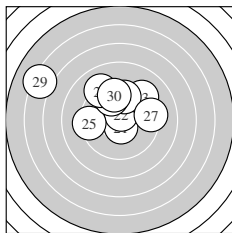

Serie 3:
 10.6 * 10.6 * 9.2 ↗ 9.7 ↑ 9.3 ←
 9.8 ↖ 9.3 → 9.1 ↖ 6.2 ↖ 9.6 ↑
 beste Teiler 78.8 (22.) 95.9 (21.) 300.8 (26.)
 Trefferlage 1.08 mm links, 2.14 mm hoch
 Streuwert 3.24, horizontal: 4.13, vertikal: 2.00

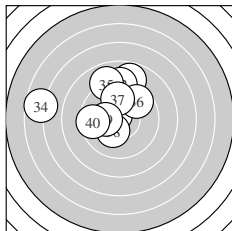

Serie 4:
 8.8 ↑ 9.1 ↑ 10.7 * 6.7 ← 8.9 ↖
 9.6 ↗ 9.9 ↑ 10.2 * 10.2 * 9.5 ←
 beste Teiler 75.0 (33.) 178.7 (38.) 187.0 (39.)
 Trefferlage 1.57 mm links, 2.00 mm hoch
 Streuwert 3.01, horizontal: 3.55, vertikal: 2.36

Unterschrift des Schützen

Ergebnis:	385.6	(369)
Serien:	98.8	94.9 97.9 94.0
Zähler:	18	15 5 2 0 0 0 0 0 0
Innenzehner:	13	
weiteste:	820 (21), 762 (32), 696 (4)	
beste Teiler	64.2 (37.)	69.2 (23.) 82.7 (19.)
Trefferlage	0.39 mm links, 1.09 mm hoch	
Streuwert	2.61, horizontal: 2.76, vertikal: 2.45	

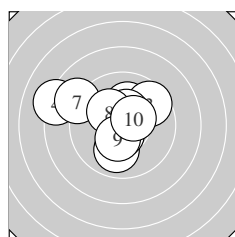
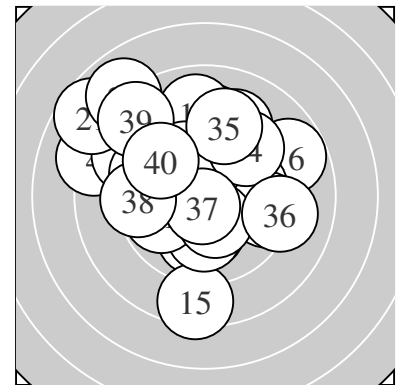

Serie 1:	10.0 ↓	10.1 ↑	9.6 ↗	8.2 ↖	10.4 *
	10.6 *	8.9 ↖	10.2 *	10.4 *	10.4 *
beste Teiler	92.5 (6.) 126.7 (10.) 134.8 (5.)				
Trefferlage	0.90 mm links, 0.74 mm hoch				
Streuwert	2.26, horizontal: 2.71, vertikal: 1.71				

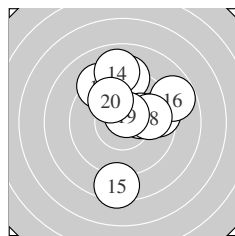

Serie 2:	9.2 ↑	9.3 ↖	9.5 →	9.0 ↑	8.4 ↓
	8.8 →	10.2 *	9.9 →	10.6 *	10.0 ↖
beste Teiler	82.7 (19.) 189.4 (17.) 247.4 (20.)				
Trefferlage	0.90 mm rechts, 1.37 mm hoch				
Streuwert	2.73, horizontal: 2.26, vertikal: 3.13				

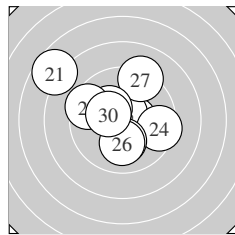

Serie 3:	7.7 ↖	10.5 *	10.7 *	9.5 →	10.1 ↓
	10.1 ↓	9.2 ↑	10.3 *	9.5 ↖	10.3 *
beste Teiler	69.2 (23.) 109.2 (22.) 153.2 (30.)				
Trefferlage	0.61 mm links, 0.75 mm hoch				
Streuwert	2.60, horizontal: 2.87, vertikal: 2.29				

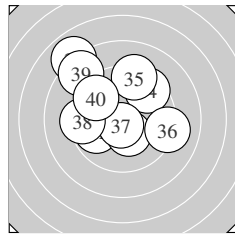

Serie 4:	9.8 ↖	7.9 ↖	10.3 *	9.5 ↗	9.2 ↑
	9.1 →	10.7 *	9.4 ←	8.5 ↖	9.6 ↖
beste Teiler	64.2 (37.) 155.0 (33.) 282.0 (31.)				
Trefferlage	0.96 mm links, 1.50 mm hoch				
Streuwert	2.93, horizontal: 3.12, vertikal: 2.73				

Unterschrift des Schützen

Ergebnis:	395.4	(380)
Serien:	95.0	101.8 97.8 100.8
Zähler:	24	13 2 1 0 0 0 0 0 0
Innenzehner:	18	
weiteste:	996	(7), 645 (9), 516 (40)
beste Teiler	91.0	(18.) 98.4 (14.) 102.6 (20.)
Trefferlage	0.86 mm	links, 0.33 mm tief
Streuwert	2.18,	horizontal: 2.55, vertikal: 1.73

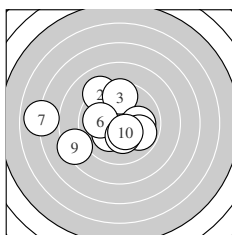
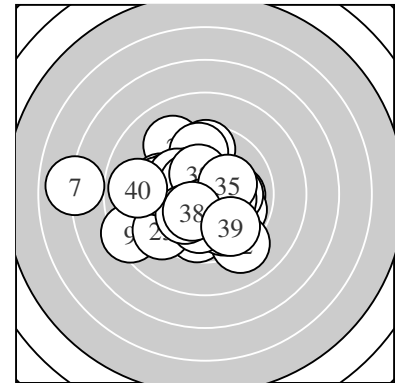

Serie 1:	10.2 *	9.2 ↘	9.6 ↑	10.0 →	9.9 ↘
	10.0 ←	7.0 ←	10.3 *	8.4 ↙	10.4 *
beste Teiler	133.6	(10.) 165.8	(8.) 187.4	(1.)	
Trefferlage	1.58 mm	links, 0.02 mm	tief		
Streuwert	3.12,	horizontal: 3.84,	vertikal: 2.16		

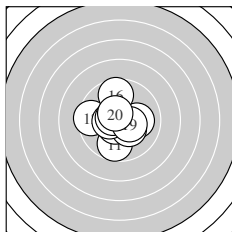

Serie 2:	9.7 ↓	9.5 ←	10.1 →	10.6 *	10.3 *
	9.7 ↑	10.4 *	10.6 *	10.4 *	10.5 *
beste Teiler	91.0	(18.) 98.4	(14.) 102.6	(20.)	
Trefferlage	0.33 mm	links, 0.10 mm	tief		
Streuwert	1.59,	horizontal: 1.61,	vertikal: 1.57		

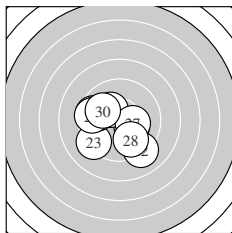

Serie 3:	9.6 ←	9.1 ↘	9.2 ↙	10.2 *	10.3 *
	9.8 ←	10.3 *	9.8 ↘	9.5 ←	10.0 ↘
beste Teiler	172.6	(27.) 173.6	(25.) 179.3	(24.)	
Trefferlage	0.89 mm	links, 0.54 mm	tief		
Streuwert	2.18,	horizontal: 2.47,	vertikal: 1.86		

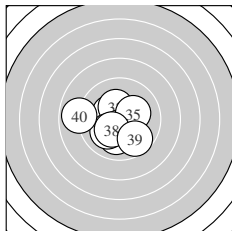

Serie 4:	10.4 *	10.3 *	10.4 *	10.5 *	10.2 *
	10.0 ↓	10.1 ↙	10.3 *	9.7 ↘	8.9 ←
beste Teiler	110.2	(34.) 143.6	(33.) 146.7	(31.)	
Trefferlage	0.63 mm	links, 0.66 mm	tief		
Streuwert	1.71,	horizontal: 1.96,	vertikal: 1.42		

Unterschrift des Schützen

Meyton Elektronik

Ergebnis: **380.1** (364)
 Serien: 98.1 95.6 94.3 92.1
 Zähler: 15 17 5 3 0 0 0 0 0 0
 Innenzehner: 6
 weiteste: 856 (38), 815 (31), 785 (5)
 beste Teiler 41.4 (33.) 114.7 (9.) 147.4 (14.)
 Trefferlage 0.66 mm links, 0.04 mm hoch
 Streuwert 2.91, horizontal: 3.31, vertikal: 2.44

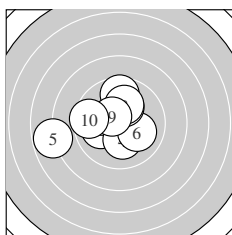
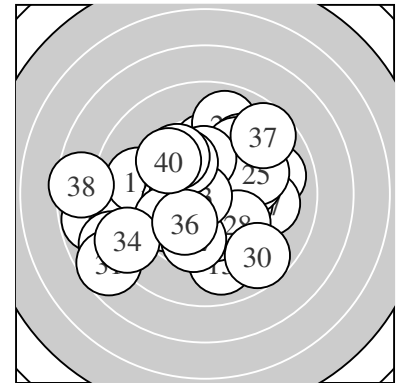

Serie 1:
 10.1 ← 10.0 ← 9.6 ↑ 10.2 * 7.8 ←
 10.1 → 10.2 * 10.1 ↑ 10.5 * 9.5 ←
 beste Teiler 114.7 (9.) 191.8 (4.) 192.3 (7.)
 Trefferlage 1.28 mm links, 0.32 mm hoch
 Streuwert 2.30, horizontal: 2.77, vertikal: 1.72

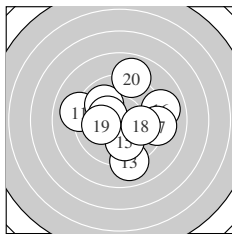

Serie 2:
 9.1 ← 9.9 ↖ 9.0 ↓ 10.4 * 10.0 ↓
 9.0 → 9.2 → 10.0 → 10.1 ← 8.9 ↑
 beste Teiler 147.4 (14.) 218.5 (19.) 248.8 (15.)
 Trefferlage 0.45 mm rechts, 0.04 mm hoch
 Streuwert 2.76, horizontal: 2.96, vertikal: 2.55

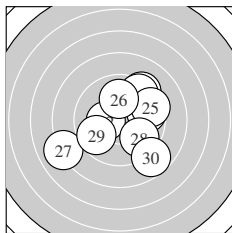

Serie 3:
 9.7 → 10.3 * 9.3 ↗ 9.5 ↗ 9.4 →
 10.0 ↑ 8.0 ← 9.7 ↘ 9.7 ← 8.7 ↘
 beste Teiler 160.3 (22.) 244.1 (26.) 302.5 (28.)
 Trefferlage 0.64 mm rechts, 0.04 mm tief
 Streuwert 3.03, horizontal: 3.32, vertikal: 2.70

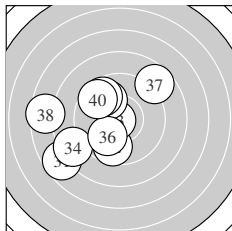

Serie 4:
 7.7 ↙ 9.7 ↓ 10.8 * 8.5 ← 9.9 ↖
 10.0 ↙ 8.7 ↗ 7.5 ← 9.7 ↖ 9.6 ↖
 beste Teiler 41.4 (33.) 240.0 (36.) 256.9 (35.)
 Trefferlage 2.49 mm links, 0.14 mm tief
 Streuwert 3.28, horizontal: 3.56, vertikal: 2.97

Unterschrift des Schützen

Meyton Elektronik

Ergebnis: **195.2** (187)
 Serien: 98.7 96.5
 Zähler: 10 7 3 0 0 0 0 0 0 0
 Innenzehner: 5
 weiteste: 641 (3), 510 (15), 509 (18)
 beste Teiler 82.0 (9.) 120.9 (20.) 133.8 (13.)
 Trefferlage 0.65 mm links, 0.41 mm tief
 Streuwert 2.35, horizontal: 2.39, vertikal: 2.30

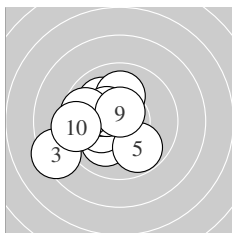
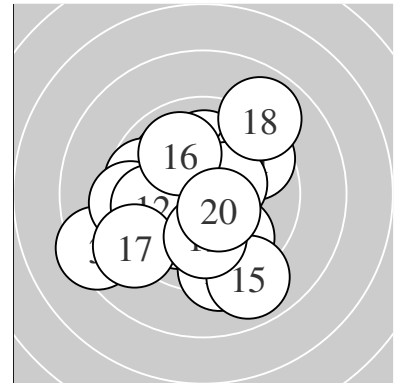

Serie 1:
 10.1 ↘ 10.3 * 8.4 ↙ 10.0 ↘ 9.8 ↘
 10.0 ↑ 10.4 * 9.7 ← 10.6 * 9.4 ←
 beste Teiler 82.0 (9.) 144.2 (7.) 174.2 (2.)
 Trefferlage 1.66 mm links, 0.17 mm tief
 Streuwert 1.95, horizontal: 2.12, vertikal: 1.76

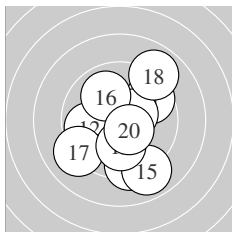

Serie 2:
 9.6 ↗ 9.8 ← 10.4 * 9.3 ↓ 8.9 ↘
 10.0 ↘ 9.1 ↙ 8.9 ↗ 10.0 ↓ 10.5 *
 beste Teiler 120.9 (20.) 133.8 (13.) 231.3 (19.)
 Trefferlage 0.36 mm rechts, 0.65 mm tief
 Streuwert 2.57, horizontal: 2.29, vertikal: 2.83

Unterschrift des Schützen

Ergebnis: **203.0** (193)
 Serien: 101.8 101.2
 Zähler: 14 5 1 0 0 0 0 0 0 0
 Innenzehner: 12
 weiteste: 539 (13), 418 (11), 402 (9)
 beste Teiler 39.0 (5.) 43.0 (12.) 58.2 (16.)
 Trefferlage 0.13 mm rechts, 0.67 mm hoch
 Streuwert 1.70, horizontal: 1.81, vertikal: 1.58

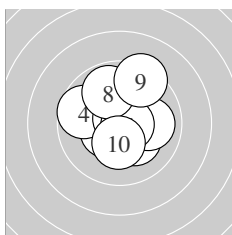
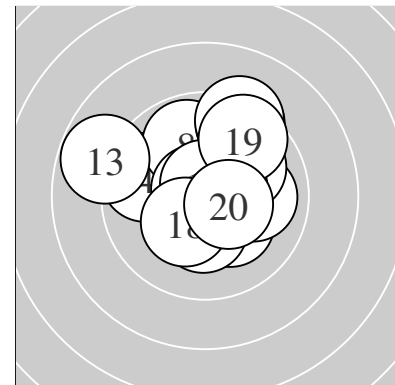

Serie 1:
 10.2 * 10.4 * 10.6 * 9.7 ↖ 10.8 *
 10.0 → 10.7 * 9.8 ↗ 9.3 ↗ 10.3 *
 beste Teiler 39.0 (5.) 67.8 (7.) 83.4 (3.)
 Trefferlage 0.18 mm rechts, 0.36 mm hoch
 Streuwert 1.62, horizontal: 1.58, vertikal: 1.65

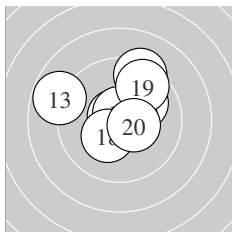

Serie 2:
 9.3 ↗ 10.8 * 8.8 ↖ 10.0 ↗ 10.6 *
 10.7 * 10.7 * 10.3 * 9.6 ↗ 10.4 *
 beste Teiler 43.0 (12.) 58.2 (16.) 59.0 (17.)
 Trefferlage 0.08 mm rechts, 0.99 mm hoch
 Streuwert 1.83, horizontal: 2.09, vertikal: 1.53

Unterschrift des Schützen

Ergebnis: **179.0** (171)
 Serien: 90.2 88.8
 Zähler: 4 8 5 2 0 1 0 0 0 0
 Innenzehner: 1
 weiteste: 1317 (13), 940 (9), 755 (12)
 beste Teiler 137.4 (11.) 218.9 (1.) 231.0 (4.)
 Trefferlage 0.72 mm rechts, 0.80 mm hoch
 Streuwert 4.05, horizontal: 5.06, vertikal: 2.68

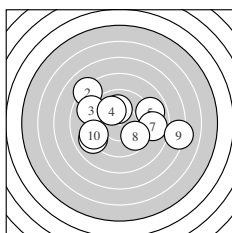
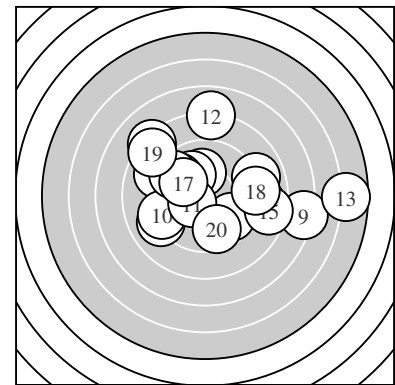

Serie 1:
 10.1 ↑ 8.2 ↘ 9.0 ↖ 10.0 ↙ 8.9 →
 9.0 ↙ 8.9 → 9.7 ↘ 7.2 → 9.2 ↙
 beste Teiler 218.9 (1.) 231.0 (4.) 312.1 (8.)
 Trefferlage 0.25 mm rechts, 0.43 mm hoch
 Streuwert 3.89, horizontal: 4.93, vertikal: 2.45

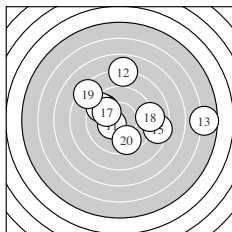

Serie 2:
 10.4 * 7.9 ↑ 5.7 → 9.7 ↖ 8.5 →
 9.5 ↖ 10.0 ↖ 9.1 → 8.4 ↖ 9.6 ↓
 beste Teiler 137.4 (11.) 240.5 (17.) 301.0 (14.)
 Trefferlage 1.19 mm rechts, 1.18 mm hoch
 Streuwert 4.37, horizontal: 5.41, vertikal: 2.98

Unterschrift des Schützen

Ergebnis: **199.2** (190)
 Serien: 101.3 97.9
 Zähler: 13 4 3 0 0 0 0 0 0 0
 Innenzehner: 9
 weiteste: 746 (16), 540 (15), 509 (8)
 beste Teiler 87.3 (1.) 95.0 (2.) 101.0 (13.)
 Trefferlage 0.52 mm rechts, 0.05 mm hoch
 Streuwert 2.15, horizontal: 1.81, vertikal: 2.45

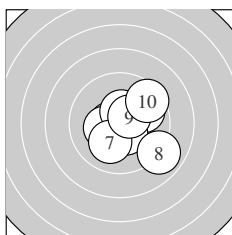
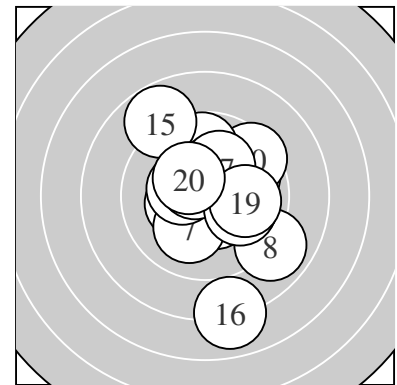

Serie 1:
 10.6 * 10.6 * 10.3 * 9.9 ↗ 10.5 *
 10.4 * 10.1 ↙ 8.9 ↘ 10.5 * 9.5 ↗
 beste Teiler 87.3 (1.) 95.0 (2.) 123.1 (9.)
 Trefferlage 0.70 mm rechts, 0.15 mm tief
 Streuwert 1.76, horizontal: 1.89, vertikal: 1.61

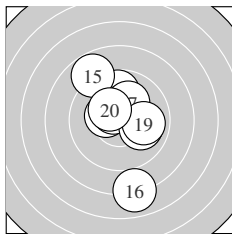

Serie 2:
 9.8 ↑ 10.4 * 10.5 * 10.0 → 8.8 ↖
 8.0 ↓ 10.1 ↗ 10.0 → 9.9 → 10.4 *
 beste Teiler 101.0 (13.) 148.0 (12.) 150.7 (20.)
 Trefferlage 0.34 mm rechts, 0.26 mm hoch
 Streuwert 2.57, horizontal: 1.82, vertikal: 3.15

Unterschrift des Schützen

Ergebnis: **195.8** (187)
 Serien: 96.0 99.8
 Zähler: 9 9 2 0 0 0 0 0 0 0
 Innenzehner: 7
 weiteste: 552 (16), 525 (9), 476 (10)
 beste Teiler 24.1 (20.) 93.4 (15.) 108.8 (17.)
 Trefferlage 0.26 mm rechts, 0.37 mm tief
 Streuwert 2.37, horizontal: 3.09, vertikal: 1.28

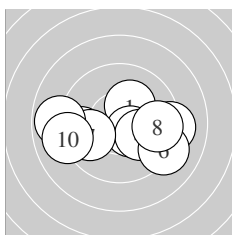
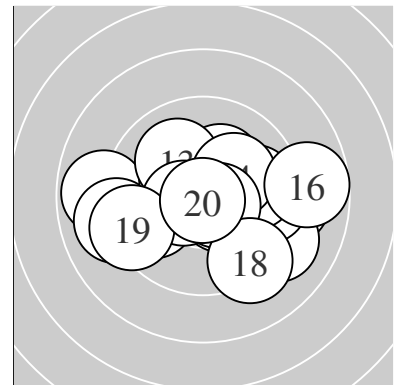

Serie 1:
 10.2 * 10.5 * 9.2 → 10.1 ↘ 9.6 ←
 9.1 ↘ 9.8 ← 9.6 → 8.9 ← 9.0 ←
 beste Teiler 121.4 (2.) 179.7 (1.) 208.2 (4.)
 Trefferlage 0.04 mm links, 0.61 mm tief
 Streuwert 2.66, horizontal: 3.62, vertikal: 1.01

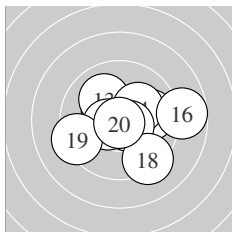

Serie 2:
 10.4 * 9.9 → 10.0 ↘ 10.2 * 10.6 *
 8.7 → 10.5 * 9.3 ↘ 9.3 ← 10.9 *
 beste Teiler 24.1 (20.) 93.4 (15.) 108.8 (17.)
 Trefferlage 0.57 mm rechts, 0.13 mm tief
 Streuwert 2.14, horizontal: 2.62, vertikal: 1.52

Unterschrift des Schützen

Ergebnis: **199.8** (190)
 Serien: 102.1 97.7
 Zähler: 11 8 1 0 0 0 0 0 0 0
 Innenzehner: 10
 weiteste: 617 (15), 457 (13), 434 (16)
 beste Teiler 15.0 (3.) 43.0 (2.) 70.3 (11.)
 Trefferlage 0.21 mm links, 0.40 mm tief
 Streuwert 2.06, horizontal: 2.26, vertikal: 1.83

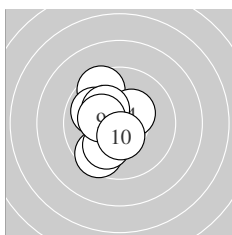
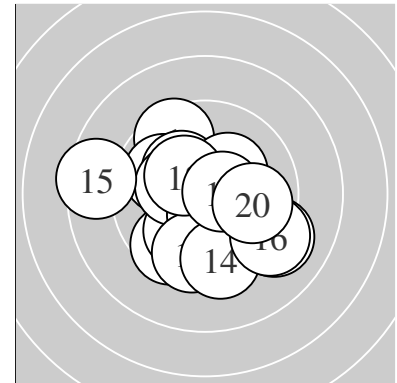

Serie 1:
 9.5 ↖ 10.8 * 10.9 * 10.4 * 9.6 ↙
 9.9 ↖ 10.0 ↙ 10.2 * 10.3 * 10.5 *
 beste Teiler 15.0 (3.) 43.0 (2.) 118.5 (10.)
 Trefferlage 0.92 mm links, 0.03 mm hoch
 Streuwert 1.47, horizontal: 1.11, vertikal: 1.75

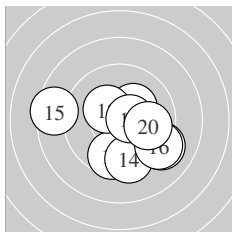

Serie 2:
 10.7 * 9.6 ↓ 9.1 ↘ 9.5 ↓ 8.5 ←
 9.2 ↘ 10.3 * 10.3 * 10.6 * 9.9 →
 beste Teiler 70.3 (11.) 97.8 (19.) 155.8 (18.)
 Trefferlage 0.50 mm rechts, 0.83 mm tief
 Streuwert 2.45, horizontal: 2.90, vertikal: 1.90

Unterschrift des Schützen

Ergebnis: **187.7** (177)
 Serien: 89.0 98.7
 Zähler: 8 9 0 0 2 0 1 0 0 0
 Innenzehner: 7
 weiteste: 1727 (7), 1041 (6), 1011 (9)
 beste Teiler 56.0 (4.) 67.2 (1.) 107.0 (2.)
 Trefferlage 2.19 mm links, 0.59 mm tief
 Streuwert 3.71, horizontal: 5.14, vertikal: 1.09

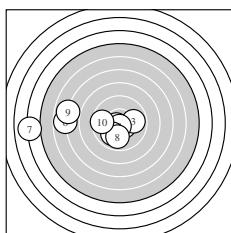
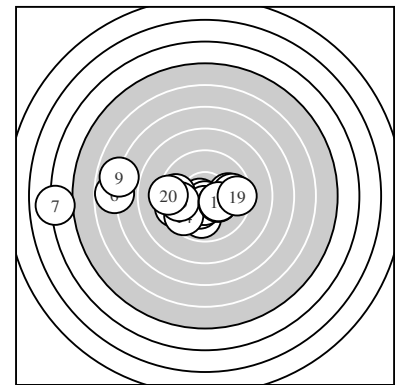

Serie 1:
 10.7 * 10.5 * 9.9 → 10.7 * 10.0 ↙
 6.8 ← 4.0 ← 9.9 ↓ 6.9 ← 9.6 ←
 beste Teiler 56.0 (4.) 67.2 (1.) 107.0 (2.)
 Trefferlage 3.98 mm links, 0.40 mm tief
 Streuwert 4.61, horizontal: 6.38, vertikal: 1.34

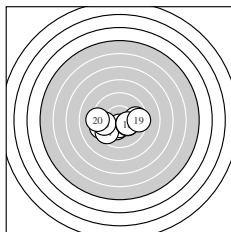

Serie 2:
 10.3 * 9.5 ← 10.5 * 9.6 ↙ 9.7 ←
 10.3 * 9.7 → 10.3 * 9.5 → 9.3 ←
 beste Teiler 110.2 (13.) 164.1 (11.) 165.4 (16.)
 Trefferlage 0.40 mm links, 0.78 mm tief
 Streuwert 2.07, horizontal: 2.82, vertikal: 0.80

Unterschrift des Schützen

Ergebnis: **189.9** (182)
 Serien: 94.6 95.3
 Zähler: 6 11 2 1 0 0 0 0 0 0
 Innenzehner: 5
 weiteste: 762 (8), 659 (3), 533 (16)
 beste Teiler 90.7 (2.) 101.3 (15.) 154.4 (19.)
 Trefferlage 0.02 mm links, 1.21 mm hoch
 Streuwert 2.80, horizontal: 3.56, vertikal: 1.75

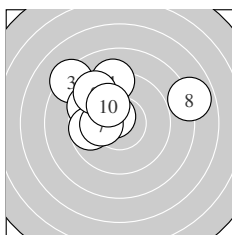
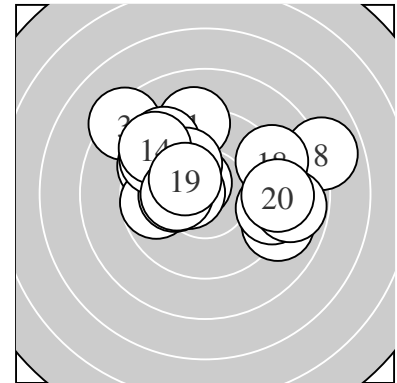

Serie 1:
 9.2 ↑ 10.6 * 8.3 ↘ 9.8 ↘ 9.5 ↘
 9.7 ← 10.2 * 7.9 → 9.3 ↘ 10.1 ↘
 beste Teiler 90.7 (2.) 188.2 (7.) 220.8 (10.)
 Trefferlage 1.30 mm links, 1.98 mm hoch
 Streuwert 2.59, horizontal: 3.26, vertikal: 1.68

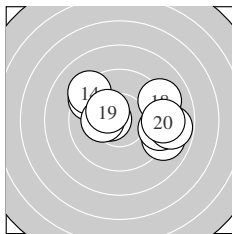

Serie 2:
 9.0 → 9.5 ↘ 9.3 → 9.3 ↘ 10.5 *
 8.8 → 10.3 * 9.1 → 10.3 * 9.2 →
 beste Teiler 101.3 (15.) 154.4 (19.) 175.0 (17.)
 Trefferlage 1.24 mm rechts, 0.43 mm hoch
 Streuwert 2.72, horizontal: 3.53, vertikal: 1.52

Unterschrift des Schützen

Ergebnis: **171.3** (164)
 Serien: 100.6 70.7
 Zähler: 11 6 0 0 0 0 0 0 0 0
 Innenzehner: 7
 weiteste: 350 (5), 306 (6), 297 (2)
 beste Teiler 94.0 (7.) 130.0 (3.) 138.5 (17.)
 Trefferlage 0.69 mm rechts, 0.57 mm hoch
 Streuwert 1.55, horizontal: 2.06, vertikal: 0.77

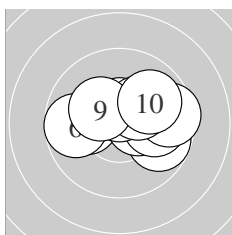
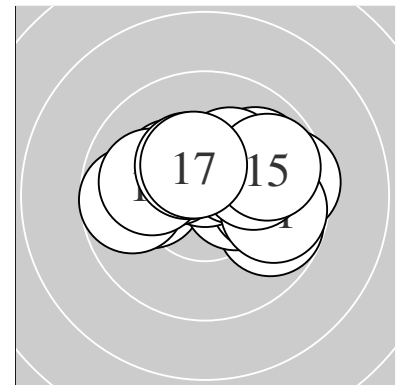

Serie 1:
 10.0 ← 9.8 → 10.4 * 10.0 → 9.6 →
 9.7 ← 10.6 * 10.3 * 10.3 * 9.9 →
 beste Teiler 94.0 (7.) 130.0 (3.) 166.4 (9.)
 Trefferlage 0.66 mm rechts, 0.36 mm hoch
 Streuwert 1.68, horizontal: 2.25, vertikal: 0.78

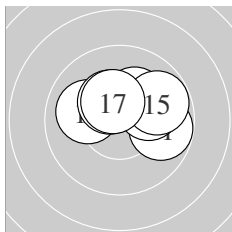

Serie 2:
 9.8 → 10.2 * 10.0 ← 10.1 → 9.8 →
 10.4 * 10.4 *
 beste Teiler 138.5 (17.) 145.4 (16.) 181.4 (12.)
 Trefferlage 0.74 mm rechts, 0.87 mm hoch
 Streuwert 1.45, horizontal: 1.93, vertikal: 0.71

Unterschrift des Schützen

Ergebnis: **165.5** (157)
 Serien: 99.2 66.3
 Zähler: 6 10 0 1 0 0 0 0 0 0
 Innenzehner: 4
 weiteste: 815 (14), 468 (15), 441 (11)
 beste Teiler 80.0 (17.) 119.9 (13.) 149.4 (2.)
 Trefferlage 0.25 mm rechts, 0.41 mm hoch
 Streuwert 2.52, horizontal: 3.38, vertikal: 1.12

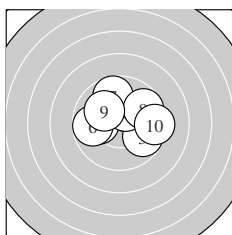
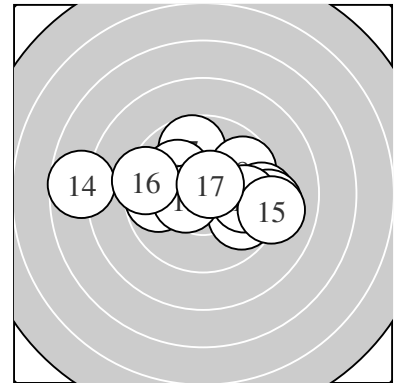

Serie 1:
 9.9 → 10.4 * 9.8 ↘ 10.0 ← 10.4 *
 9.8 ← 9.7 ↑ 9.7 ↗ 10.1 ↖ 9.4 →
 beste Teiler 149.4 (2.) 150.2 (5.) 218.3 (9.)
 Trefferlage 0.52 mm rechts, 0.72 mm hoch
 Streuwert 1.91, horizontal: 2.39, vertikal: 1.27

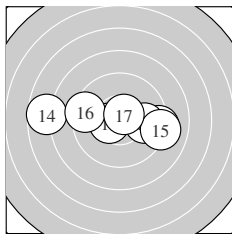

Serie 2:
 9.2 → 9.8 → 10.5 * 7.7 ← 9.1 →
 9.4 ← 10.6 *
 beste Teiler 80.0 (17.) 119.9 (13.) 278.9 (12.)
 Trefferlage 0.13 mm links, 0.02 mm tief
 Streuwert 3.33, horizontal: 4.65, vertikal: 0.75

Unterschrift des Schützen

Ergebnis: **105.4** (101)
 Serien: 96.5 8.9
 Zähler: 5 3 3 0 0 0 0 0 0 0
 Innenzehner: 3
 weiteste: 667 (6), 633 (1), 504 (11)
 beste Teiler 102.0 (3.) 124.5 (10.) 157.9 (9.)
 Trefferlage 0.57 mm rechts, 1.75 mm hoch
 Streuwert 2.55, horizontal: 2.78, vertikal: 2.29

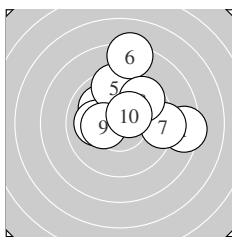
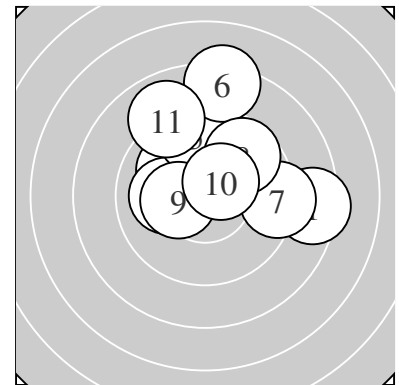

Serie 1:
 8.4 → 10.0 ↘ 10.5 * 10.1 ← 9.5 ↑
 8.3 ↑ 9.2 → 9.7 ↗ 10.3 * 10.5 *
 beste Teiler 102.0 (3.) 124.5 (10.) 157.9 (9.)
 Trefferlage 0.85 mm rechts, 1.47 mm hoch
 Streuwert 2.50, horizontal: 2.75, vertikal: 2.22

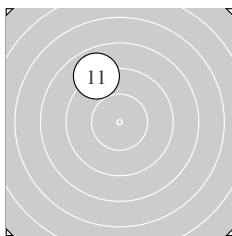

Serie 2:
 8.9 ↘
 beste Teiler 504.9 (11.)
 Trefferlage 2.27 mm links, 4.51 mm hoch
 Streuwert 0.00, horizontal: 0.00, vertikal: 0.00

Unterschrift des Schützen

Ergebnis: **200.7** (191)
 Serien: 99.4 101.3
 Zähler: 14 3 3 0 0 0 0 0 0 0
 Innenzehner: 12
 weiteste: 644 (10), 511 (8), 508 (7)
 beste Teiler 3.6 (2.) 56.0 (4.) 66.4 (14.)
 Trefferlage 0.07 mm rechts, 0.14 mm tief
 Streuwert 2.06, horizontal: 2.83, vertikal: 0.73

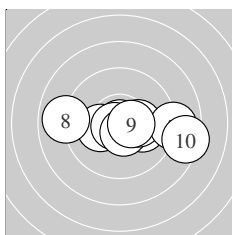
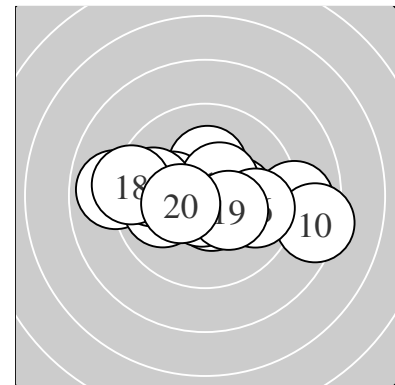

Serie 1:
 10.2 * 10.9 * 10.1 → 10.7 * 10.6 *
 10.2 * 8.9 → 8.9 ← 10.5 * 8.4 →
 beste Teiler 3.6 (2.) 56.0 (4.) 95.8 (5.)
 Trefferlage 0.93 mm rechts, 0.36 mm tief
 Streuwert 2.33, horizontal: 3.25, vertikal: 0.53

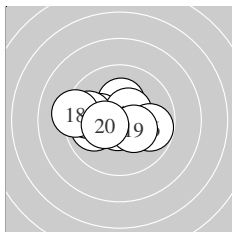

Serie 2:
 10.3 * 10.2 * 10.0 ← 10.7 * 10.5 *
 9.8 → 9.8 ← 9.3 ← 10.3 * 10.4 *
 beste Teiler 66.4 (14.) 114.5 (15.) 145.7 (20.)
 Trefferlage 0.78 mm links, 0.06 mm hoch
 Streuwert 1.65, horizontal: 2.16, vertikal: 0.85

Unterschrift des Schützen

Ergebnis: **187.6** (179)
 Serien: 95.0 92.6
 Zähler: 7 9 1 2 1 0 0 0 0 0
 Innenzehner: 4
 weiteste: 1048 (13), 953 (11), 814 (2)
 beste Teiler 87.0 (7.) 114.8 (9.) 119.1 (17.)
 Trefferlage 0.81 mm links, 0.05 mm tief
 Streuwert 3.42, horizontal: 4.42, vertikal: 1.94

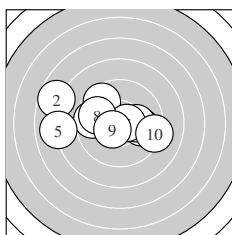
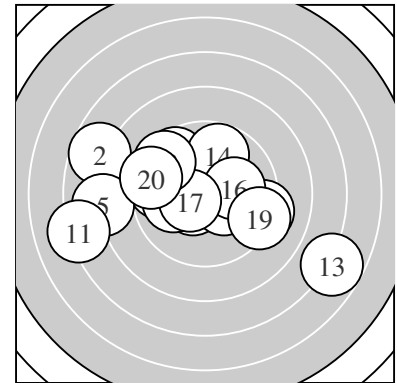

Serie 1:
 9.6 ← 7.7 ↖ 9.9 → 9.6 ↘ 8.0 ←
 10.1 → 10.6 * 9.8 ← 10.5 * 9.2 →
 beste Teiler 87.0 (7.) 114.8 (9.) 203.0 (6.)
 Trefferlage 1.43 mm links, 0.36 mm hoch
 Streuwert 3.00, horizontal: 4.00, vertikal: 1.41

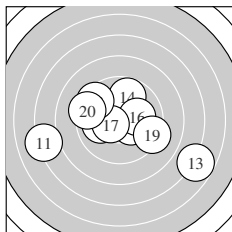

Serie 2:
 7.1 ← 10.0 ← 6.8 ↘ 9.8 ↗ 10.3 *
 10.1 → 10.5 * 9.5 ↘ 9.2 ↘ 9.3 ←
 beste Teiler 119.1 (17.) 156.1 (15.) 213.7 (16.)
 Trefferlage 0.18 mm links, 0.46 mm tief
 Streuwert 3.87, horizontal: 4.94, vertikal: 2.37

Unterschrift des Schützen

Ergebnis: **190.5** (180)
 Serien: 95.0 95.5
 Zähler: 5 10 5 0 0 0 0 0 0 0
 Innenzehner: 4
 weiteste: 744 (6), 672 (13), 665 (4)
 beste Teiler 70.6 (17.) 75.3 (7.) 107.7 (1.)
 Trefferlage 1.80 mm links, 0.96 mm hoch
 Streuwert 2.58, horizontal: 3.42, vertikal: 1.26

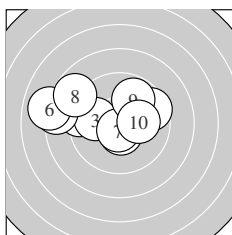
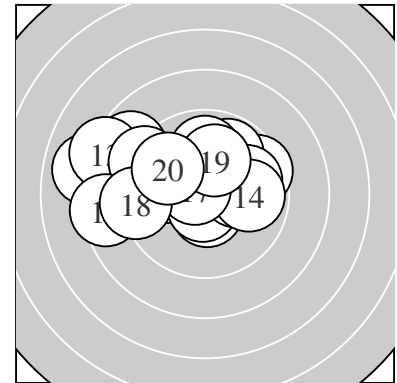

Serie 1:
 10.5 * 9.3 ← 9.9 ← 8.3 ← 9.5 →
 8.0 ← 10.7 * 8.8 ↖ 9.8 ↗ 10.2 *
 beste Teiler 75.3 (7.) 107.7 (1.) 197.5 (10.)
 Trefferlage 1.85 mm links, 0.90 mm hoch
 Streuwert 2.77, horizontal: 3.70, vertikal: 1.27

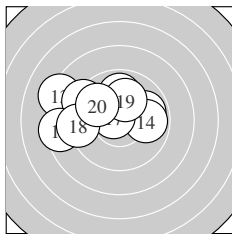

Serie 2:
 9.9 ↑ 9.9 → 8.3 ↖ 9.9 → 9.3 ↖
 8.4 ← 10.7 * 9.2 ← 10.1 ↗ 9.8 ↖
 beste Teiler 70.6 (17.) 217.1 (19.) 263.0 (11.)
 Trefferlage 1.75 mm links, 1.02 mm hoch
 Streuwert 2.53, horizontal: 3.32, vertikal: 1.32

Unterschrift des Schützen