

Ergebnis: **193.0** (183)
 Serien: 93.7 99.3
 Zähler: 8 10 1 0 0 1 0 0 0 0 0
 Innenzehner: 4
 Weitesten: 1279 (5.), 571 (4.), 424 (17.)
 beste Teiler: 88.6 (11.), 97.3 (2.), 104.2 (3.)
 Trefferlage: 1.49 mm rechts, 0.72 mm hoch
 Streuwert: 2.72, horizontal: 3.61, vertikal: 1.34

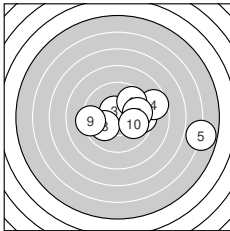
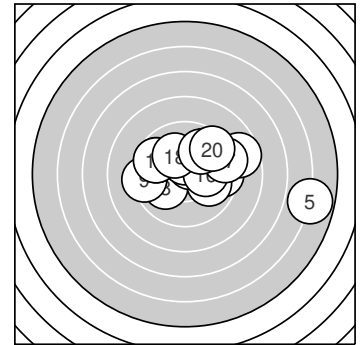

Serie 1: 93.7 (88)

9.5 →	10.6* →	10.5* ↘	8.7 →	5.8 →
9.7 ↗	9.7 →	10.0 ↙	9.3 ←	9.9 →

beste Teiler: 97.3 (2.), 104.2 (3.), 230.7 (8.)
 Trefferlage: 2.34 mm rechts, 0.07 mm hoch
 Streuwert: 3.37, horizontal: 4.52, vertikal: 1.51

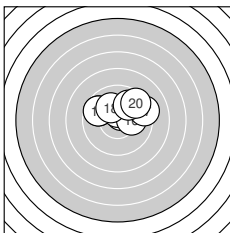

Serie 2: 99.3 (95)

10.6* ↗	10.5* ↑	9.7 ↖	10.0 →	9.7 ↖
10.1 →	9.3 →	10.1 ↘	9.8 ↗	9.5 ↗

beste Teiler: 88.6 (11.), 118.0 (12.), 208.0 (16.)
 Trefferlage: 0.64 mm rechts, 1.36 mm hoch
 Streuwert: 1.74, horizontal: 2.34, vertikal: 0.74



Ergebnis: **183.5** (172)
 Serien: 94.6 88.9
 Zähler: 5 8 4 1 1 1 0 0 0 0 0
 Innenzehner: 4
 Weitester: 1314 (14.), 1038 (4.), 763 (17.)
 beste Teiler: 119.5 (2.), 144.8 (1.), 171.0 (6.)
 Trefferlage: 3.49 mm rechts, 0.62 mm hoch
 Streuwert: 2.94, horizontal: 3.87, vertikal: 1.54

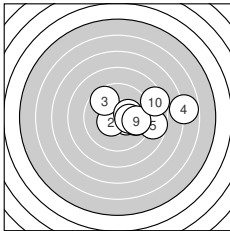
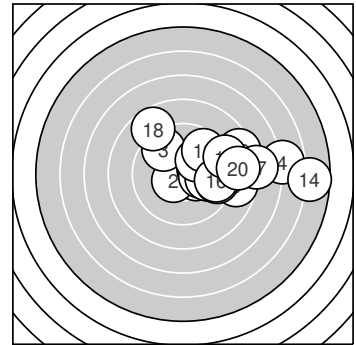

Serie 1: 94.6 (89)

10.4* → 10.5* ↙ 9.7 ↘
 10.3* → 9.8 → 10.2* →

6.8 → 8.7 →
 9.8 → 8.4 →

beste Teiler: 119.5 (2.), 144.8 (1.), 171.0 (6.)
 Trefferlage: 2.91 mm rechts, 0.32 mm hoch
 Streuwert: 2.69, horizontal: 3.57, vertikal: 1.33

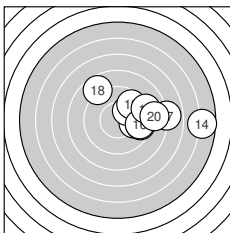

Serie 2: 88.9 (83)

9.9 → 10.1 ↗ 9.7 ↗
 9.6 → 7.9 → 8.7 ↘

5.7 → 9.5 →
 9.1 → 8.7 →

beste Teiler: 205.0 (12.), 253.1 (11.), 325.5 (13.)
 Trefferlage: 4.07 mm rechts, 0.92 mm hoch
 Streuwert: 3.25, horizontal: 4.25, vertikal: 1.74



Ergebnis: 197.7 (189)
Serien: 101.4 96.3
Zähler: 11 7 2 0 0 0 0 0 0 0
Innenzehner: 9
Weiteste: 593 (11.), 566 (18.), 493 (5.)
beste Teiler: 34.5 (16.), 48.7 (1.), 71.5 (4.)
Trefferlage: 0.48 mm links, 0.73 mm tief
Streuwert: 2.24, horizontal: 2.77, vertikal: 1.52

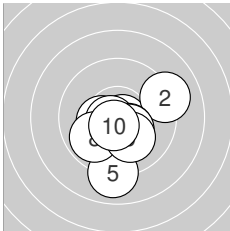
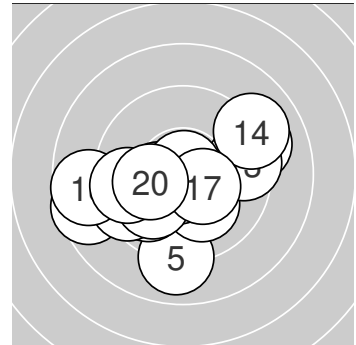

Serie 1: 101.4 (97)

10.8* ↘	9.1 →	10.4* ←	10.7* ←	9.0 ↓
10.4* ↘	10.4* ↘	9.9 ↙	10.1 ↘	10.6* ↙

beste Teiler: 48.7 (1.), 71.5 (4.), 80.1 (10.)
Trefferlage: 0.28 mm rechts, 1.03 mm tief
Streuwert: 1.72, horizontal: 1.74, vertikal: 1.69

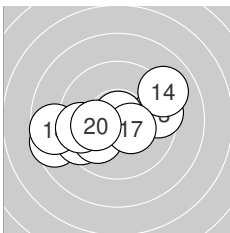

Serie 2: 96.3 (92)

8.6 ←	9.5 ←	9.5 →	9.0 →	10.0 ↙
10.8* ↑	10.4* ↘	8.7 ←	9.6 ←	10.2* ←

beste Teiler: 34.5 (16.), 138.7 (17.), 199.3 (20.)
Trefferlage: 1.26 mm links, 0.43 mm tief
Streuwert: 2.61, horizontal: 3.44, vertikal: 1.34



Ergebnis: **194.1** (186)
 Serien: 98.5 95.6
 Zähler: 9 8 3 0 0 0 0 0 0 0
 Innenzehner: 5
 Weitester: 589 (20.), 534 (17.), 502 (11.)
 beste Teiler: 26.1 (10.), 89.8 (4.), 122.6 (12.)
 Trefferlage: 0.86 mm links, 1.39 mm tief
 Streuwert: 2.24, horizontal: 2.84, vertikal: 1.40

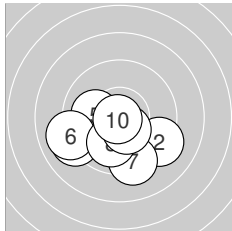
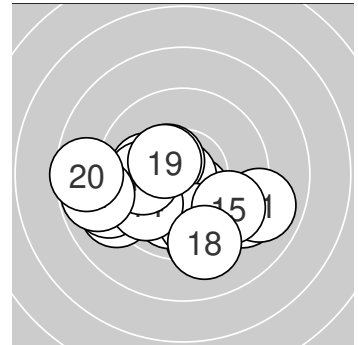

Serie 1: 98.5 (96)

10.0 ↙	9.2 ↘	9.1 ↙	10.6* ↙	10.1 ↙
9.0 ↙	9.3 ↓	10.0 ↓	10.4* ↓	10.8* ↙

beste Teiler: 26.1 (10.), 89.8 (4.), 130.7 (9.)
 Trefferlage: 0.89 mm links, 1.52 mm tief
 Streuwert: 1.94, horizontal: 2.45, vertikal: 1.24

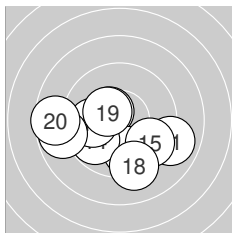

Serie 2: 95.6 (90)

8.9 ↘	10.5* ↘	9.8 ↓	9.8 ↙	9.6 ↘
10.0 ↙	8.8 ↙	9.2 ↓	10.4* ↘	8.6 ↙

beste Teiler: 122.6 (12.), 136.4 (19.), 245.0 (16.)
 Trefferlage: 0.83 mm links, 1.26 mm tief
 Streuwert: 2.61, horizontal: 3.32, vertikal: 1.61



LG 20 ZR

StandNr: 105

Spiss, Markus #70225099

Jugend_I_männl.

Wertung

StartNr: 5

04.03.2023 11:14

SG_Kappl

Ergebnis: **0.0** (0)_{DNS}
Serien:
Zähler: 0 0 0 0 0 0 0 0 0 0 0
Innenzehner: 0
Weiteste:
~~beste Teiler~~Schütze ist nicht zum Wettkampf angetreten
Trefferlage: 0.00 mm , 0.00 mm
Streuwert:

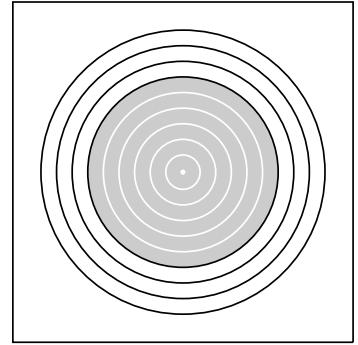

Ergebnis: **201.9** (192)
 Serien: 101.4 100.5
 Zähler: 12 8 0 0 0 0 0 0 0 0
 Innenzehner: 10
 Weitesten: 446 (3.), 404 (15.), 377 (11.)
 beste Teiler: 9.2 (2.), 47.6 (1.), 101.7 (5.)
 Trefferlage: 0.54 mm rechts, 0.50 mm tief
 Streuwert: 1.66, horizontal: 1.98, vertikal: 1.25

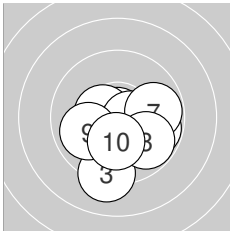
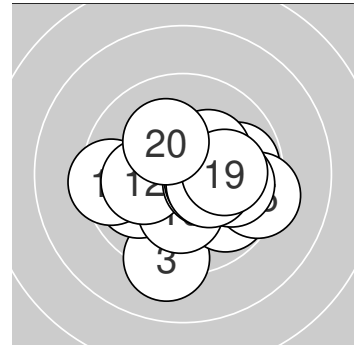

Serie 1: 101.4 (95)

10.8* ← 10.9* ↑ 9.2 ↓
 9.8 → 9.8 → 9.8 ↘
 beste Teiler: 9.2 (2.), 47.6 (1.), 101.7 (5.)
 Trefferlage: 0.38 mm rechts, 0.92 mm tief
 Streuwert: 1.62, horizontal: 1.74, vertikal: 1.48

10.5* ← 10.5* →
 9.9 ← 10.2* ↓

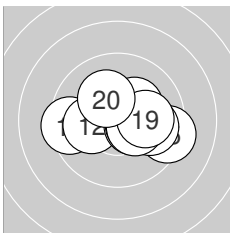

Serie 2: 100.5 (97)

9.4 ← 10.1 ← 10.4* →
 10.3* ↗ 9.9 → 10.4* →
 beste Teiler: 127.9 (13.), 132.9 (14.), 147.2 (18.)
 Trefferlage: 0.70 mm rechts, 0.08 mm tief
 Streuwert: 1.72, horizontal: 2.28, vertikal: 0.85

10.4* → 9.3 →
 10.1 → 10.2* ↖



Ergebnis: **205.1** (196)
 Serien: 102.8 102.3
 Zähler: 17 2 1 0 0 0 0 0 0 0
 Innenzehner: 14
 Weitesten: 542 (13.), 320 (5.), 252 (16.)
 beste Teiler: 44.4 (6.), 49.9 (1.), 56.0 (15.)
 Trefferlage: 0.22 mm links, 0.64 mm hoch
 Streuwert: 1.43, horizontal: 1.75, vertikal: 1.00

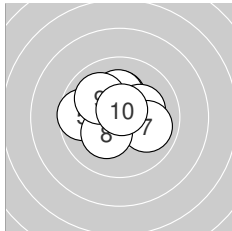
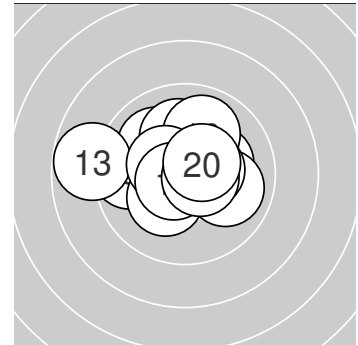

Serie 1: 102.8 (99)

10.8* ↗	10.2* ↑	10.2* ↑	10.2* →	9.7 ←
10.8* ↑	10.0 ↘	10.2* ↙	10.0 ↘	10.7* ↑

beste Teiler: 44.4 (6.), 49.9 (1.), 67.7 (10.)
 Trefferlage: 0.13 mm links, 0.54 mm hoch
 Streuwert: 1.36, horizontal: 1.60, vertikal: 1.06

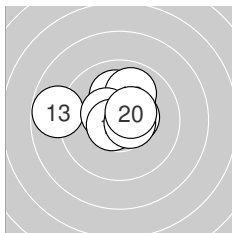

Serie 2: 102.3 (97)

10.1 ↑	10.5* →	8.8 ←	10.2* ↗	10.7* ←
9.9 ↗	10.4* ↘	10.6* ↙	10.6* →	10.5* ↗

beste Teiler: 56.0 (15.), 76.8 (18.), 91.2 (19.)
 Trefferlage: 0.31 mm links, 0.75 mm hoch
 Streuwert: 1.56, horizontal: 1.97, vertikal: 0.98



Ergebnis: **189.2** (182)
 Serien: 93.3 95.9
 Zähler: 7 8 5 0 0 0 0 0 0 0 0
 Innenzehner: 1
 Weitestе: 629 (15.), 585 (5.), 542 (10.)
 beste Teiler: 195.0 (9.), 211.0 (14.), 214.6 (16.)
 Trefferlage: 0.31 mm rechts, 2.56 mm hoch
 Streuwert: 2.20, horizontal: 2.58, vertikal: 1.74

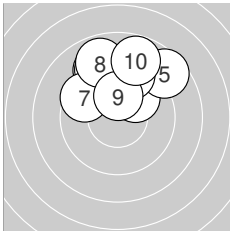
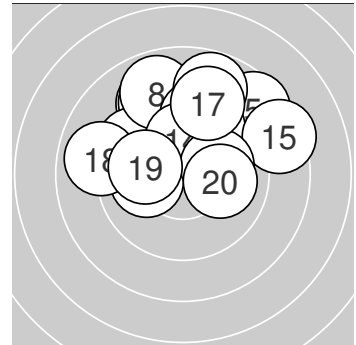

Serie 1: 93.3 (89)

9.6 ↗ 9.1 ↖ 10.0 ↗
 9.4 ↗ 9.6 ↖ 8.9 ↖
 beste Teiler: 195.0 (9.), 240.6 (3.), 332.0 (1.)
 Trefferlage: 0.17 mm rechts, 3.52 mm hoch
 Streuwert: 1.80, horizontal: 2.20, vertikal: 1.29

9.1 ↖ 8.6 ↗
 10.2* ↑ 8.8 ↗

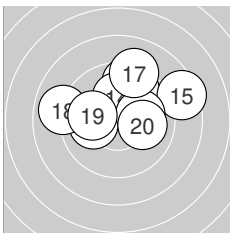

Serie 2: 95.9 (93)

9.5 ↗ 9.7 ↗ 10.1 ←
 10.1 → 9.1 ↗ 8.9 ←
 beste Teiler: 211.0 (14.), 214.6 (16.), 224.2 (13.)
 Trefferlage: 0.45 mm rechts, 1.61 mm hoch
 Streuwert: 2.43, horizontal: 3.02, vertikal: 1.64

10.1 ↑ 8.4 →
 10.0 ← 10.0 →



Ergebnis: **191.2** (182)
 Serien: 96.3 94.9
 Zähler: 8 7 4 1 0 0 0 0 0 0 0
 Innenzehner: 7
 Weitestе: 777 (16.), 697 (17.), 604 (10.)
 beste Teiler: 60.7 (9.), 93.4 (15.), 100.0 (3.)
 Trefferlage: 1.18 mm links, 0.93 mm hoch
 Streuwert: 2.72, horizontal: 3.50, vertikal: 1.59

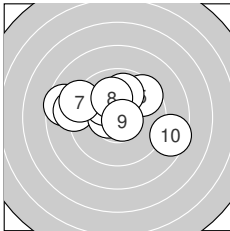
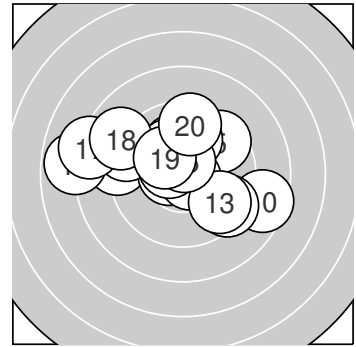

Serie 1: 96.3 (92)

8.6 ←	9.0 ←	10.6* ←	10.2* ↖	9.5 ↗
9.9 ↑	9.2 ↙	10.1 ↑	10.7* ↘	8.5 ↘

beste Teiler: 60.7 (9.), 100.0 (3.), 190.9 (4.)
 Trefferlage: 0.80 mm links, 0.97 mm hoch
 Streuwert: 2.65, horizontal: 3.48, vertikal: 1.39

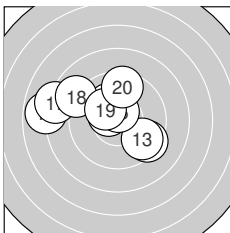

Serie 2: 94.9 (90)

10.5* ↙	9.4 ↘	9.6 ↘	10.2* ↖	10.6* ↑
7.8 ←	8.2 ↙	8.9 ↙	10.2* ↖	9.5 ↑

beste Teiler: 93.4 (15.), 109.5 (11.), 176.9 (19.)
 Trefferlage: 1.57 mm links, 0.89 mm hoch
 Streuwert: 2.90, horizontal: 3.67, vertikal: 1.84



Ergebnis: **202.5** (194)
 Serien: 99.6 102.9
 Zähler: 14 6 0 0 0 0 0 0 0 0 0
 Innenzehner: 11
 Weitestе: 428 (4.), 376 (16.), 372 (8.)
 beste Teiler: 31.8 (14.), 53.3 (18.), 72.1 (17.)
 Trefferlage: 0.22 mm links, 0.03 mm hoch
 Streuwert: 1.67, horizontal: 2.11, vertikal: 1.06

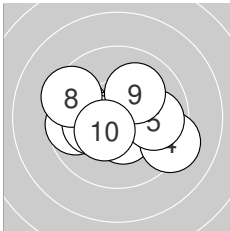
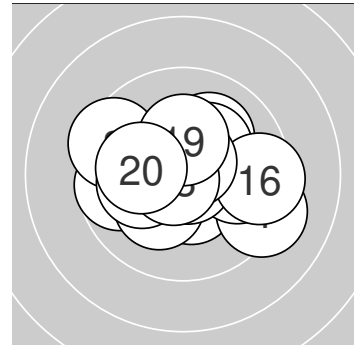

Serie 1: 99.6 (95)

9.8 ←	10.4* ↓	10.4* ←	9.2 →	9.9 →
9.7 ←	10.2* ←	9.5 ←	10.1 ↗	10.4* ↘

beste Teiler: 127.7 (2.), 136.4 (10.), 145.6 (3.)
 Trefferlage: 0.52 mm links, 0.18 mm tief
 Streuwert: 1.95, horizontal: 2.50, vertikal: 1.15

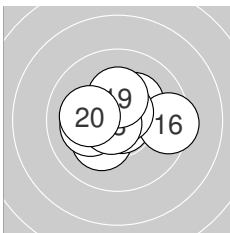

Serie 2: 102.9 (99)

10.2* ↙	10.3* ↗	10.1 ←	10.8* ↘	10.3* ↗
9.4 →	10.7* ↗	10.7* ←	10.3* ↑	10.1 ←

beste Teiler: 31.8 (14.), 53.3 (18.), 72.1 (17.)
 Trefferlage: 0.07 mm rechts, 0.25 mm hoch
 Streuwert: 1.39, horizontal: 1.71, vertikal: 0.97



Ergebnis: **185.3** (177)
 Serien: 89.7 95.6
 Zähler: 5 8 6 1 0 0 0 0 0 0
 Innenzehner: 2
 Weitestе: 757 (4.), 689 (1.), 661 (2.)
 beste Teiler: 106.0 (14.), 186.0 (16.), 212.6 (10.)
 Trefferlage: 0.52 mm links, 0.00 mm
 Streuwert: 3.31, horizontal: 4.23, vertikal: 2.03

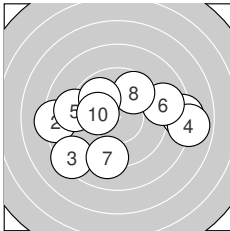
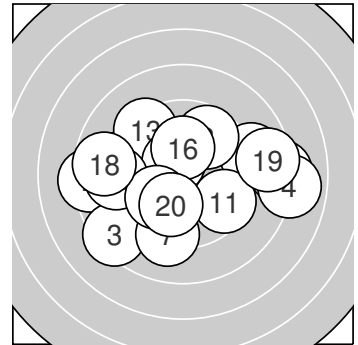

Serie 1: 89.7 (85)

8.2 →	8.3 ←	8.4 ↙	7.9 →	9.1 ←
8.9 →	9.2 ↓	9.7 ↗	9.9 ↘	10.1 ←

beste Teiler: 212.6 (10.), 272.9 (9.), 310.9 (8.)
 Trefferlage: 0.01 mm links, 0.25 mm tief
 Streuwert: 3.92, horizontal: 5.02, vertikal: 2.35

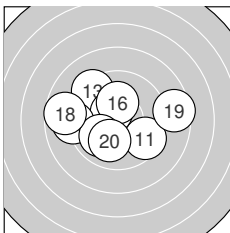

Serie 2: 95.6 (92)

9.6 ↘	9.7 ↙	9.3 ↘	10.5* ↘	9.1 ←
10.2* ↑	10.0 ↙	8.7 ←	8.5 →	10.0 ↓

beste Teiler: 106.0 (14.), 186.0 (16.), 232.1 (20.)
 Trefferlage: 1.03 mm links, 0.26 mm hoch
 Streuwert: 2.73, horizontal: 3.45, vertikal: 1.73



Ergebnis: 176.8 (169)
Serien: 89.7 87.1
Zähler: 3 9 4 2 2 0 0 0 0 0 0
Innenzehner: 3
Weiteste: 1119 (16.), 1097 (7.), 903 (19.)
beste Teiler: 136.3 (12.), 193.0 (1.), 198.3 (8.)
Trefferlage: 0.22 mm rechts, 1.33 mm hoch
Streuwert: 4.26, horizontal: 5.84, vertikal: 1.51

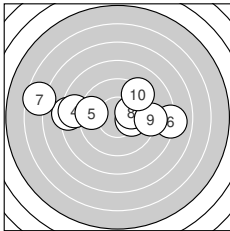
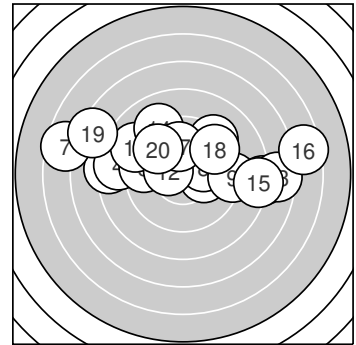

Serie 1: 89.7 (86)

10.2* → 9.9 → 8.2 ←
 8.1 → 6.6 ← 10.2* →
beste Teiler: 193.0 (1.), 198.3 (8.), 263.1 (2.)
Trefferlage: 0.60 mm links, 0.77 mm hoch
Streuwert: 4.15, horizontal: 5.74, vertikal: 1.21

8.6 ← 9.5 ←
 9.1 → 9.3 ↗

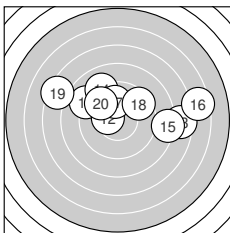

Serie 2: 87.1 (83)

9.0 ↖ 10.4* ← 7.5 →
 6.5 → 9.9 ↑ 9.5 ↗
beste Teiler: 136.3 (12.), 252.5 (17.), 323.1 (20.)
Trefferlage: 1.05 mm rechts, 1.89 mm hoch
Streuwert: 4.47, horizontal: 6.11, vertikal: 1.63

9.1 ↖ 8.2 →
 7.3 ↖ 9.7 ↖



Ergebnis: **204.5** (196)
 Serien: 103.1 101.4
 Zähler: 16 4 0 0 0 0 0 0 0 0 0
 Innenzehner: 14
 Weitestе: 361 (19.), 346 (20.), 300 (18.)
 beste Teiler: 85.0 (13.), 87.1 (14.), 87.9 (9.)
 Trefferlage: 0.25 mm links, 0.25 mm hoch
 Streuwert: 1.42, horizontal: 1.66, vertikal: 1.14

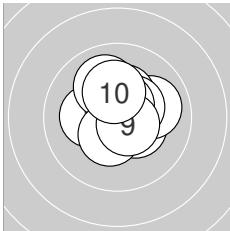
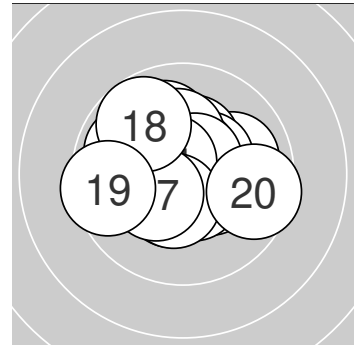

Serie 1: 103.1 (100)

10.4* ↘	10.0 →	10.2* ←	10.3* ↑	10.4* ↗
10.0 ↙	10.6* ↑	10.4* ↓	10.6* ↘	10.2* ↑

beste Teiler: 87.9 (9.), 92.3 (7.), 131.4 (5.)
 Trefferlage: 0.26 mm rechts, 0.54 mm hoch
 Streuwert: 1.16, horizontal: 1.20, vertikal: 1.11

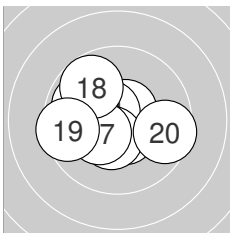

Serie 2: 101.4 (96)

10.5* ↓	9.9 ↖	10.6* ↗	10.6* ↖	10.4* ↓
10.2* ←	10.3* ↗	9.8 ↙	9.5 ←	9.6 →

beste Teiler: 85.0 (13.), 87.1 (14.), 103.8 (11.)
 Trefferlage: 0.77 mm links, 0.04 mm tief
 Streuwert: 1.60, horizontal: 1.94, vertikal: 1.15



Ergebnis: 184.2 (174)
Serien: 92.2 92.0
Zähler: 5 6 7 2 0 0 0 0 0 0 0
Innenzehner: 5
Weiteste: 920 (15.), 778 (10.), 735 (14.)
beste Teiler: 65.5 (13.), 107.0 (2.), 157.0 (11.)
Trefferlage: 0.56 mm rechts, 0.19 mm hoch
Streuwert: 3.57, horizontal: 4.84, vertikal: 1.46

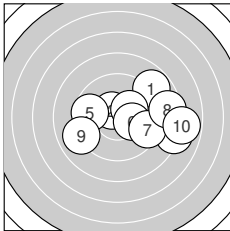
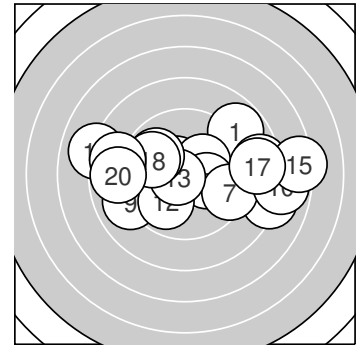

Serie 1: 92.2 (88)

8.8 ↗ 10.5* ↘ 10.3* ↗ 8.1 → 9.6 ←
 10.2* → 9.4 → 8.5 → 9.0 ← 7.8 →
beste Teiler: 107.0 (2.), 171.9 (3.), 181.8 (6.)
Trefferlage: 2.29 mm rechts, 0.05 mm tief
Streuwert: 3.18, horizontal: 4.15, vertikal: 1.75

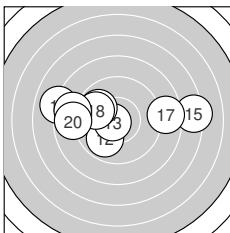

Serie 2: 92.0 (86)

10.3* ← 9.9 ↙ 10.7* ← 8.0 ← 7.3 →
 9.9 ↘ 8.6 → 9.8 ↘ 8.7 ← 8.8 ←
beste Teiler: 65.5 (13.), 157.0 (11.), 265.7 (12.)
Trefferlage: 1.15 mm links, 0.44 mm hoch
Streuwert: 3.67, horizontal: 5.06, vertikal: 1.15



Ergebnis: **204.0** (195)
 Serien: 101.1 102.9
 Zähler: 15 5 0 0 0 0 0 0 0 0
 Innenzehner: 14
 Weitesten: 442 (14.), 356 (9.), 347 (4.)
 beste Teiler: 16.1 (20.), 21.5 (16.), 24.0 (19.)
 Trefferlage: 0.33 mm rechts, 0.12 mm hoch
 Streuwert: 1.58, horizontal: 1.94, vertikal: 1.10

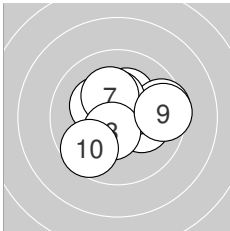
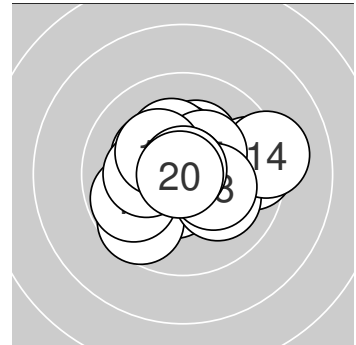

Serie 1: 101.1 (97)

10.5* ↙	10.3* ↘	10.3* ↗	9.6 →	10.2* →
10.4* ↑	10.2* ↑	10.5* ↓	9.5 →	9.6 ↙

beste Teiler: 115.4 (1.), 117.0 (8.), 139.5 (6.)
 Trefferlage: 0.36 mm rechts, 0.19 mm hoch
 Streuwert: 1.69, horizontal: 1.98, vertikal: 1.34

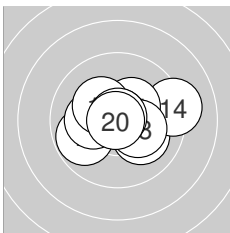

Serie 2: 102.9 (98)

10.1 ↘	9.8 ↙	10.2* ←	9.2 →	10.3* ↗
10.9* ↑	10.3* ↘	10.3* →	10.9* ↑	10.9* ←

beste Teiler: 16.1 (20.), 21.5 (16.), 24.0 (19.)
 Trefferlage: 0.29 mm rechts, 0.05 mm hoch
 Streuwert: 1.55, horizontal: 2.01, vertikal: 0.88



Ergebnis: 201.5 (192)
Serien: 100.4 101.1
Zähler: 13 6 1 0 0 0 0 0 0 0 0
Innenzehner: 7
Weiteste: 549 (7.), 419 (17.), 291 (8.)
beste Teiler: 80.0 (19.), 86.4 (11.), 87.0 (6.)
Trefferlage: 0.43 mm links, 0.84 mm tief
Streuwert: 1.64, horizontal: 1.74, vertikal: 1.53

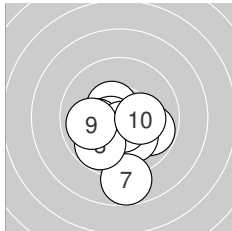
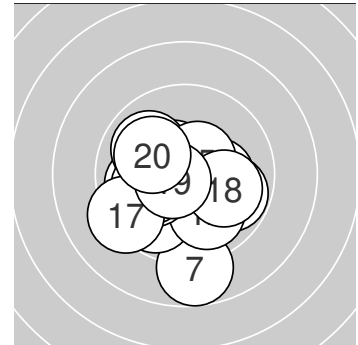

Serie 1: 100.4 (95)

10.5* ↖	10.6* ↙	10.1 ←	9.8 →	10.1 ↘
10.6* ↓	8.8 ↓	9.8 ↘	9.9 ←	10.2* →

beste Teiler: 87.0 (6.), 87.2 (2.), 113.6 (1.)
Trefferlage: 0.12 mm links, 1.23 mm tief
Streuwert: 1.71, horizontal: 1.69, vertikal: 1.73

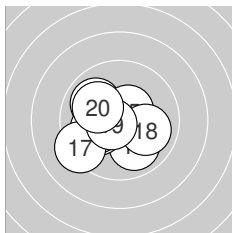

Serie 2: 101.1 (97)

10.6* ↓	9.9 ↘	9.9 ↘	10.1 ←	10.5* ↗
10.1 ←	9.3 ↙	10.0 →	10.6* ↙	10.1 ↖

beste Teiler: 80.0 (19.), 86.4 (11.), 111.9 (15.)
Trefferlage: 0.74 mm links, 0.46 mm tief
Streuwert: 1.58, horizontal: 1.83, vertikal: 1.29



Ergebnis: **192.6** (184)
 Serien: 96.5 96.1
 Zähler: 8 8 4 0 0 0 0 0 0 0
 Innenzehner: 6
 Weitestе: 715 (10.), 571 (15.), 565 (14.)
 beste Teiler: 120.8 (3.), 162.8 (7.), 166.7 (4.)
 Trefferlage: 1.51 mm rechts, 0.35 mm tief
 Streuwert: 2.44, horizontal: 3.00, vertikal: 1.70

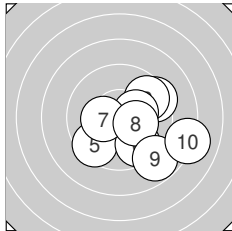
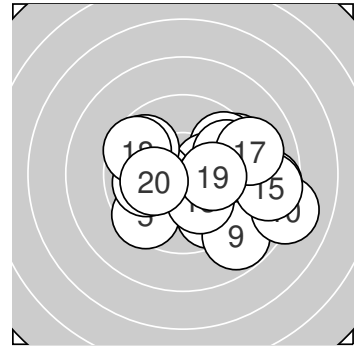

Serie 1: 96.5 (92)

9.4 ↗ 9.6 ↗ 10.5* → 10.3* → 9.5 ↙
 9.7 ↘ 10.3* ← 10.3* → 8.8 ↘ 8.1 →
 beste Teiler: 120.8 (3.), 162.8 (7.), 166.7 (4.)
 Trefferlage: 1.85 mm rechts, 0.88 mm tief
 Streuwert: 2.33, horizontal: 2.61, vertikal: 2.00

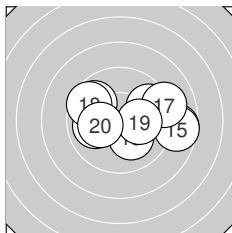

Serie 2: 96.1 (92)

10.0 ← 9.7 → 10.1 ↘ 8.7 → 8.7 →
 9.8 ↖ 9.1 → 9.6 ↖ 10.2* → 10.2* ←
 beste Teiler: 196.5 (19.), 196.6 (20.), 203.8 (13.)
 Trefferlage: 1.18 mm rechts, 0.17 mm hoch
 Streuwert: 2.59, horizontal: 3.45, vertikal: 1.23



Ergebnis: **194.5** (186)
 Serien: 98.3 96.2
 Zähler: 11 6 1 2 0 0 0 0 0 0 0
 Innenzehner: 6
 Weitestе: 1000 (15.), 756 (4.), 517 (17.)
 beste Teiler: 135.8 (18.), 137.0 (7.), 145.4 (5.)
 Trefferlage: 0.39 mm rechts, 0.18 mm tief
 Streuwert: 2.70, horizontal: 2.49, vertikal: 2.90

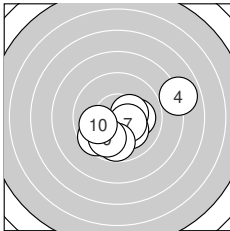
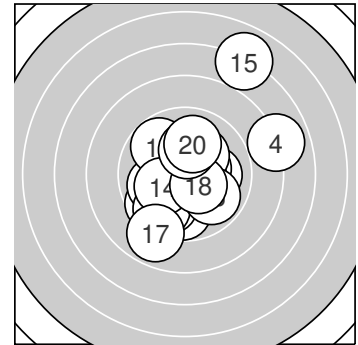

Serie 1: 98.3 (94)

10.1 ↙	10.1 →	9.6 ↘	7.9 →	10.4* →
10.1 ↘	10.4* ↘	9.8 ↓	9.9 ↙	10.0 ←

beste Teiler: 137.0 (7.), 145.4 (5.), 205.1 (6.)
 Trefferlage: 0.59 mm rechts, 0.96 mm tief
 Streuwert: 2.31, horizontal: 2.84, vertikal: 1.61

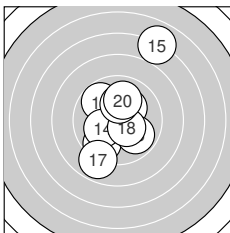

Serie 2: 96.2 (92)

10.2* ↗	9.8 ↘	9.6 ↙	10.2* ↙	7.0 ↗
9.9 ↘	8.9 ↙	10.4* ↘	10.2* ↑	10.0 ↑

beste Teiler: 135.8 (18.), 189.7 (19.), 190.1 (11.)
 Trefferlage: 0.18 mm rechts, 0.58 mm hoch
 Streuwert: 3.06, horizontal: 2.22, vertikal: 3.72



Ergebnis: 189.4 (180)
Serien: 94.5 94.9
Zähler: 5 11 3 1 0 0 0 0 0 0 0
Innenzehner: 3
Weiteste: 917 (8.), 693 (9.), 615 (17.)
beste Teiler: 82.6 (5.), 120.3 (3.), 140.6 (20.)
Trefferlage: 1.33 mm links, 1.56 mm hoch
Streuwert: 2.67, horizontal: 3.43, vertikal: 1.55

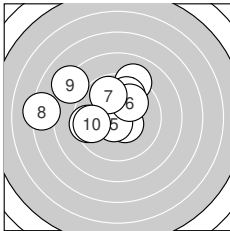
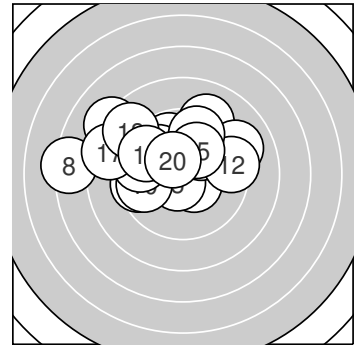

Serie 1: 94.5 (90)

9.1 ↗ 9.8 ↗ 10.5* ↘
 10.0 ↗ 9.8 ↖ 7.3 ←
beste Teiler: 82.6 (5.), 120.3 (3.), 227.2 (6.)
Trefferlage: 1.78 mm links, 1.27 mm hoch
Streuwert: 2.91, horizontal: 3.59, vertikal: 2.02

9.5 ← 10.6* ↙
 8.2 ↘ 9.7 ←

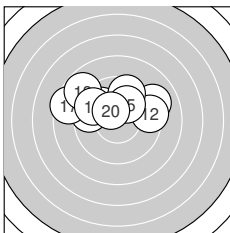

Serie 2: 94.9 (90)

9.1 ↗ 9.4 → 9.9 ↘ 9.6 ↗ 10.1 ↗
 9.5 ← 8.5 ← 8.8 ↘ 9.6 ↘ 10.4* ↘
beste Teiler: 140.6 (20.), 219.0 (15.), 260.0 (13.)
Trefferlage: 0.89 mm links, 1.85 mm hoch
Streuwert: 2.49, horizontal: 3.40, vertikal: 0.90



Ergebnis: **187.0** (176)
 Serien: 91.4 95.6
 Zähler: 4 11 3 1 1 0 0 0 0 0 0
 Innenzehner: 4
 Weitestе: 1022 (1.), 820 (5.), 641 (3.)
 beste Teiler: 86.0 (6.), 110.4 (20.), 117.4 (11.)
 Trefferlage: 0.35 mm rechts, 0.39 mm hoch
 Streuwert: 3.37, horizontal: 4.55, vertikal: 1.40

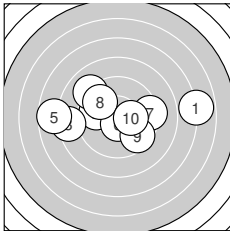
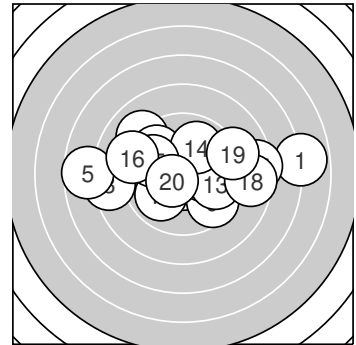

Serie 1: 91.4 (86)

6.9 → 9.8 ← 8.4 ← 9.0 ↖ 7.7 ←
 10.6* ↓ 9.3 → 9.8 ↘ 9.6 ↘ 10.3* →
 beste Teiler: 86.0 (6.), 171.2 (10.), 282.6 (2.)
 Trefferlage: 0.44 mm links, 0.35 mm hoch
 Streuwert: 3.97, horizontal: 5.38, vertikal: 1.57

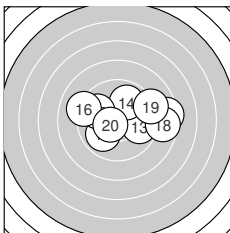

Serie 2: 95.6 (90)

10.5* ↗ 9.9 ↙ 9.8 → 9.9 ↗ 9.8 ↖
 9.1 ← 8.4 → 8.6 → 9.1 → 10.5* ↙
 beste Teiler: 110.4 (20.), 117.4 (11.), 256.7 (14.)
 Trefferlage: 1.16 mm rechts, 0.43 mm hoch
 Streuwert: 2.73, horizontal: 3.64, vertikal: 1.30



Ergebnis: **192.3** (183)
 Serien: 96.6 95.7
 Zähler: 5 13 2 0 0 0 0 0 0 0
 Innenzehner: 2
 Weitestе: 591 (8.), 533 (1.), 493 (11.)
 beste Teiler: 141.7 (2.), 150.9 (18.), 205.4 (19.)
 Trefferlage: 0.80 mm links, 2.10 mm tief
 Streuwert: 2.01, horizontal: 2.22, vertikal: 1.77

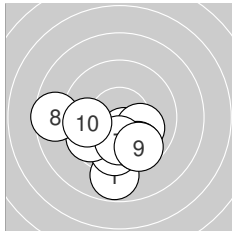
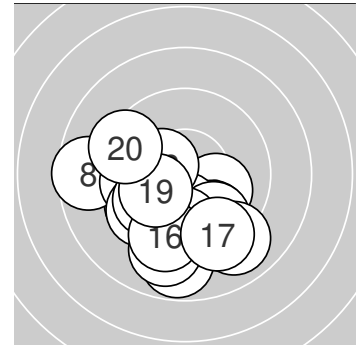

Serie 1: 96.6 (91)

8.8 ↓	10.4* ↓	10.1 ↘	9.7 ↓	9.7 ↙
9.7 ↘	10.1 ↓	8.6 ←	9.7 ↘	9.8 ←

beste Teiler: 141.7 (2.), 212.0 (7.), 212.8 (3.)
 Trefferlage: 0.68 mm links, 2.04 mm tief
 Streuwert: 2.07, horizontal: 2.50, vertikal: 1.53

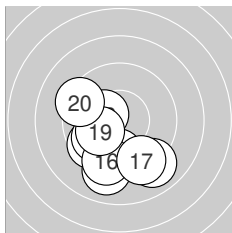

Serie 2: 95.7 (92)

9.0 ↘	9.7 ↓	9.6 ↙	9.9 ↙	9.0 ↓
9.4 ↓	9.3 ↘	10.4* ↖	10.1 ↙	9.3 ↖

beste Teiler: 150.9 (18.), 205.4 (19.), 269.2 (14.)
 Trefferlage: 0.91 mm links, 2.15 mm tief
 Streuwert: 2.05, horizontal: 2.04, vertikal: 2.06



Ergebnis: **188.4** (179)
 Serien: 91.8 96.6
 Zähler: 5 11 3 0 1 0 0 0 0 0 0
 Innenzehner: 2
 Weitester: 1188 (2.), 729 (4.), 671 (10.)
 beste Teiler: 150.4 (8.), 159.2 (7.), 216.8 (3.)
 Trefferlage: 1.35 mm links, 0.10 mm hoch
 Streuwert: 3.13, horizontal: 4.15, vertikal: 1.54

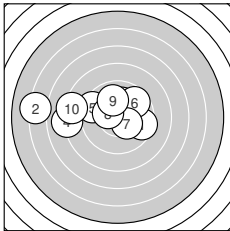
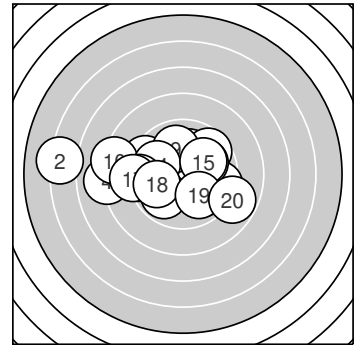

Serie 1: 91.8 (88)

9.5 → 6.2 ← 10.1 ↑
 9.7 ↗ 10.3* ↘ 10.4* ←

8.0 ← 9.4 ↖
 9.9 ↑ 8.3 ←

beste Teiler: 150.4 (8.), 159.2 (7.), 216.8 (3.)
 Trefferlage: 2.35 mm links, 0.88 mm hoch
 Streuwert: 3.58, horizontal: 4.90, vertikal: 1.30

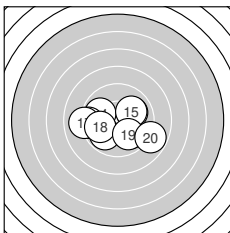

Serie 2: 96.6 (91)

9.9 ↙ 9.9 ↘ 10.0 →
 9.3 ← 9.0 ← 9.9 ←

9.9 ↖ 10.0 ↗
 9.9 ↘ 8.8 ↘

beste Teiler: 231.3 (15.), 236.1 (13.), 252.0 (19.)
 Trefferlage: 0.35 mm links, 0.67 mm tief
 Streuwert: 2.46, horizontal: 3.19, vertikal: 1.40



Ergebnis: **138.4** (130)
 Serien: 72.7 65.7
 Zähler: 1 0 6 4 6 1 0 1 0 0 1
 Innenzehner: 0
 Weitesten: 2920 (11.), 1826 (16.), 1441 (1.)
 beste Teiler: 250.5 (13.), 524.1 (8.), 561.0 (18.)
 Trefferlage: 1.81 mm rechts, 5.86 mm hoch
 Streuwert: 7.17, horizontal: 8.00, vertikal: 6.23

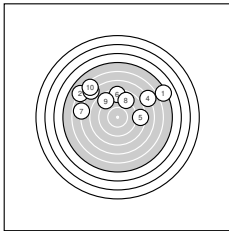
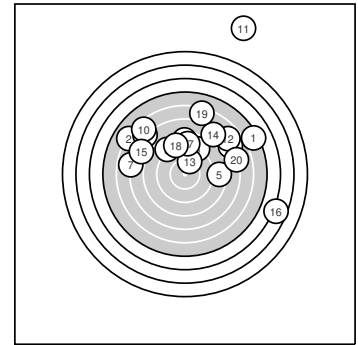

Serie 1: 72.7 (68)

5.2 ↗	6.0 ↘	6.8 ↘	7.0 ↗	8.4 →
8.4 ↑	6.9 ←	8.9 ↗	8.7 ↘	6.4 ↘

beste Teiler: 524.1 (8.), 566.1 (9.), 636.0 (6.)
 Trefferlage: 0.90 mm links, 5.15 mm hoch
 Streuwert: 6.08, horizontal: 8.21, vertikal: 2.58

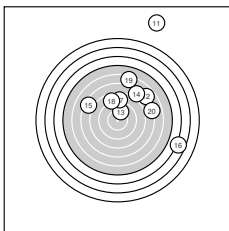

Serie 2: 65.7 (62)

0.0 ↗	6.8 ↗	10.0 ↗	7.3 ↗	7.3 ↘
3.6 ↘	8.7 ↑	8.7 ↘	6.3 ↑	7.0 →

beste Teiler: 250.5 (13.), 561.0 (18.), 568.2 (17.)
 Trefferlage: 4.53 mm rechts, 6.57 mm hoch
 Streuwert: 7.92, horizontal: 7.16, vertikal: 8.61



LG 20 ZR

StandNr: 124

Krepatz, Daniel #70412066

Jugend_I_männl.

Wertung

StartNr: 24

04.03.2023 11:14

SG_Angerberg

Ergebnis: **0.0** (0)_{DNS}
Serien:
Zähler: 0 0 0 0 0 0 0 0 0 0 0
Innenzehner: 0
Weiteste:
~~beste Teiler~~Schütze ist nicht zum Wettkampf angetreten
Trefferlage: 0.00 mm , 0.00 mm
Streuwert:

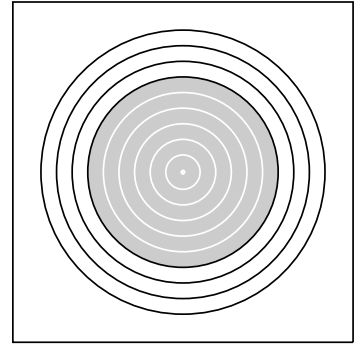

Ergebnis: **199.7** (192)
 Serien: 101.4 98.3
 Zähler: 12 8 0 0 0 0 0 0 0 0
 Innenzehner: 8
 Weitesten: 487 (12.), 422 (1.), 392 (16.)
 beste Teiler: 97.0 (20.), 102.4 (5.), 124.8 (2.)
 Trefferlage: 0.49 mm rechts, 0.41 mm hoch
 Streuwert: 1.87, horizontal: 2.00, vertikal: 1.74

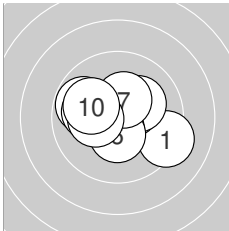
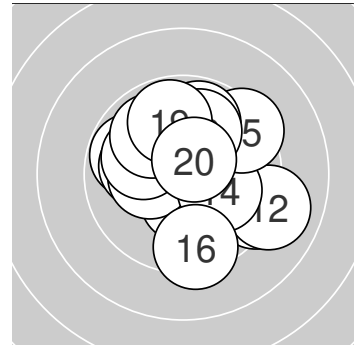

Serie 1: 101.4 (98)

9.3 ↘	10.5* ↗	9.8 ↖	10.2* ↗	10.5* ↓
10.4* ↓	10.4* ↑	10.0 ←	10.3* ←	10.0 ↖

beste Teiler: 102.4 (5.), 124.8 (2.), 137.0 (6.)
 Trefferlage: 0.18 mm links, 0.11 mm hoch
 Streuwert: 1.66, horizontal: 2.06, vertikal: 1.12

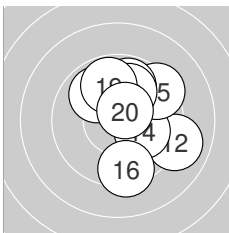

Serie 2: 98.3 (94)

10.3* ↗	9.0 ↘	9.9 ↘	10.1 ↘	9.4 ↗
9.4 ↓	9.8 ↑	10.0 ↑	9.8 ↑	10.6* ↗

beste Teiler: 97.0 (20.), 173.5 (11.), 212.7 (14.)
 Trefferlage: 1.18 mm rechts, 0.71 mm hoch
 Streuwert: 2.01, horizontal: 1.77, vertikal: 2.22



Ergebnis: **196.6** (188)
 Serien: 102.7 93.9
 Zähler: 12 4 4 0 0 0 0 0 0 0
 Innenzehner: 7
 Weitestе: 606 (20.), 580 (17.), 516 (19.)
 beste Teiler: 49.0 (3.), 61.1 (1.), 110.1 (2.)
 Trefferlage: 0.36 mm links, 0.03 mm tief
 Streuwert: 2.35, horizontal: 1.88, vertikal: 2.74

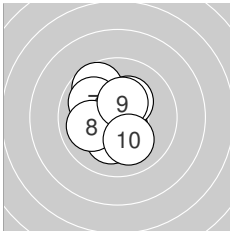
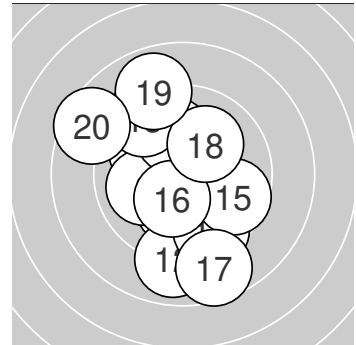

Serie 1: 102.7 (99)

10.7* ↓	10.5* ↓	10.8* ↑	10.3* ↗	9.7 ↖
10.2* ↓	10.0 ↖	10.0 ←	10.4* ↑	10.1 ↓

beste Teiler: 49.0 (3.), 61.1 (1.), 110.1 (2.)
 Trefferlage: 0.39 mm links, 0.08 mm hoch
 Streuwert: 1.40, horizontal: 1.24, vertikal: 1.55

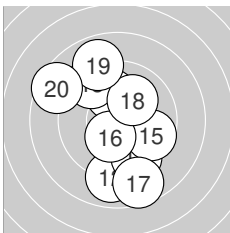

Serie 2: 93.9 (89)

10.0 ↑	8.9 ↓	9.4 ↖	9.5 ↓	9.7 ↗
10.3* ↓	8.6 ↓	10.1 ↗	8.9 ↑	8.5 ↖

beste Teiler: 158.4 (16.), 220.8 (18.), 233.8 (11.)
 Trefferlage: 0.34 mm links, 0.15 mm tief
 Streuwert: 3.11, horizontal: 2.44, vertikal: 3.66



Ergebnis: 152.1 (143)
Serien: 78.1 74.0
Zähler: 0 6 3 2 7 1 1 0 0 0 0
Innenzehner: 0
Weiteste: 1586 (5.), 1424 (18.), 1182 (19.)
beste Teiler: 321.9 (2.), 335.2 (16.), 339.1 (17.)
Trefferlage: 2.15 mm links, 4.66 mm hoch
Streuwert: 5.53, horizontal: 6.87, vertikal: 3.73

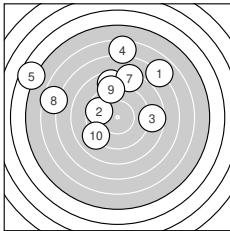
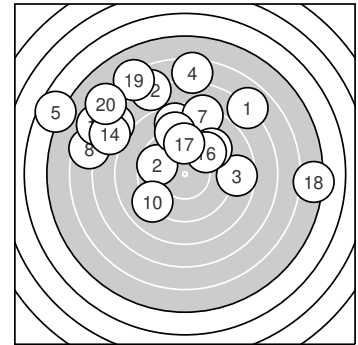

Serie 1: 78.1 (73)

6.9 ↗	9.7 ↖	8.7 →	6.5 ↑	4.6 ↘
8.7 ↑	8.2 ↑	6.6 ↖	9.1 ↑	9.1 ↘

beste Teiler: 321.9 (2.), 470.4 (10.), 472.7 (9.)
Trefferlage: 1.83 mm links, 4.27 mm hoch
Streuwert: 5.52, horizontal: 6.60, vertikal: 4.17

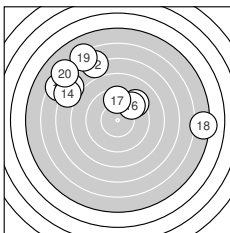

Serie 2: 74.0 (70)

6.5 ↘	6.9 ↖	7.1 ↘	7.2 ↘	9.3 ↗
9.6 ↗	9.6 ↑	5.3 →	6.2 ↖	6.3 ↘

beste Teiler: 335.2 (16.), 339.1 (17.), 407.3 (15.)
Trefferlage: 2.47 mm links, 5.06 mm hoch
Streuwert: 5.81, horizontal: 7.48, vertikal: 3.40



Ergebnis: 194.7 (188)
Serien: 94.4 100.3
Zähler: 11 7 1 1 0 0 0 0 0 0 0
Innenzehner: 7
Weiteste: 828 (4.), 696 (2.), 488 (6.)
beste Teiler: 69.5 (9.), 81.3 (20.), 90.4 (10.)
Trefferlage: 0.13 mm rechts, 1.47 mm hoch
Streuwert: 2.43, horizontal: 2.82, vertikal: 1.97

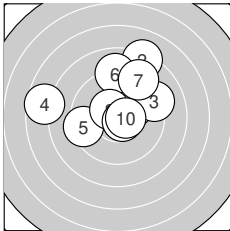
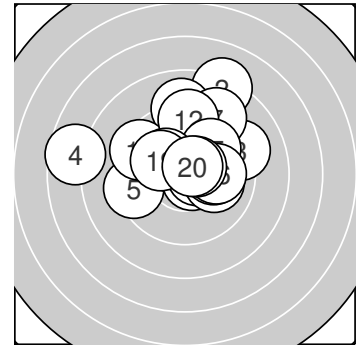

Serie 1: 94.4 (91)

10.2* ↗ 8.2 ↑ 9.2 → 7.6 ← 9.4 ←
 9.0 ↑ 9.0 ↗ 10.5* ↘ 10.7* ↘ 10.6* →
beste Teiler: 69.5 (9.), 90.4 (10.), 122.3 (8.)
Trefferlage: 0.08 mm links, 1.90 mm hoch
Streuwert: 3.07, horizontal: 3.58, vertikal: 2.46

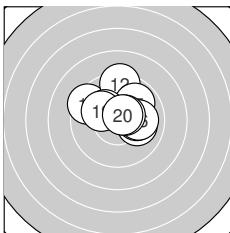

Serie 2: 100.3 (97)

9.4 ↘ 9.3 ↑ 10.1 → 10.1 → 9.9 ↗
 10.0 → 10.6* ↗ 10.2* ↘ 10.1 ↖ 10.6* ↗
beste Teiler: 81.3 (20.), 100.9 (17.), 182.5 (18.)
Trefferlage: 0.36 mm rechts, 1.04 mm hoch
Streuwert: 1.67, horizontal: 1.96, vertikal: 1.32



Ergebnis: **191.2** (182)
 Serien: 95.6 95.6
 Zähler: 8 8 3 0 1 0 0 0 0 0 0
 Innenzehner: 6
 Weitester: 1036 (7.), 570 (18.), 567 (19.)
 beste Teiler: 72.4 (8.), 105.9 (16.), 141.1 (15.)
 Trefferlage: 2.03 mm rechts, 1.18 mm hoch
 Streuwert: 2.45, horizontal: 3.20, vertikal: 1.31

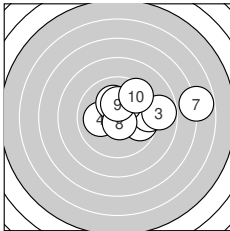
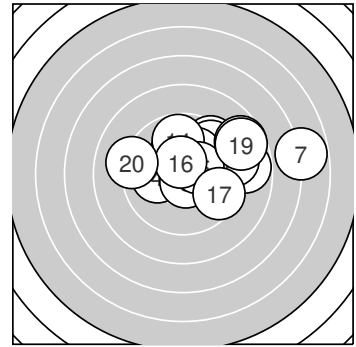

Serie 1: 95.6 (91)

9.7 →	9.3 →	8.8 →	10.1 ←	10.2* ↑
10.2* ↑	6.8 →	10.7* ↓	10.3* ↑	9.5 ↗

beste Teiler: 72.4 (8.), 172.0 (9.), 191.8 (6.)
 Trefferlage: 2.33 mm rechts, 0.91 mm hoch
 Streuwert: 2.68, horizontal: 3.58, vertikal: 1.24

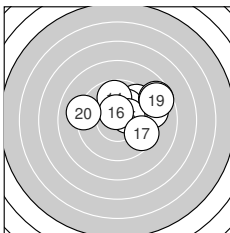

Serie 2: 95.6 (91)

9.6 ↗	9.2 →	10.1 ↗	9.8 ↑	10.4* →
10.5* ↑	9.5 ↘	8.7 ↗	8.7 →	9.1 ←

beste Teiler: 105.9 (16.), 141.1 (15.), 210.6 (13.)
 Trefferlage: 1.72 mm rechts, 1.45 mm hoch
 Streuwert: 2.30, horizontal: 2.93, vertikal: 1.39



Ergebnis: 184.4 (176)
Serien: 90.6 93.8
Zähler: 6 6 6 2 0 0 0 0 0 0 0
Innenzehner: 4
Weiteste: 881 (10.), 858 (11.), 702 (17.)
beste Teiler: 87.6 (20.), 115.9 (14.), 150.6 (1.)
Trefferlage: 0.40 mm links, 0.80 mm tief
Streuwert: 3.53, horizontal: 4.17, vertikal: 2.75

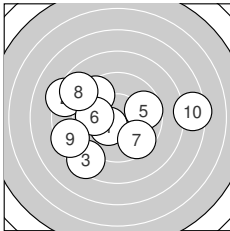
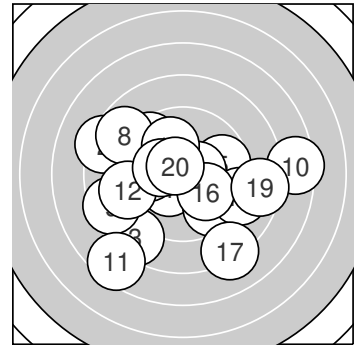

Serie 1: 90.6 (85)

10.4* ↙	8.3 ↖	8.5 ↘	9.5 ↖	9.7 →
9.9 ←	9.6 ↘	8.8 ↖	8.5 ←	7.4 →

beste Teiler: 150.6 (1.), 269.2 (6.), 315.8 (5.)
Trefferlage: 1.23 mm links, 0.14 mm tief
Streuwert: 3.77, horizontal: 4.66, vertikal: 2.59

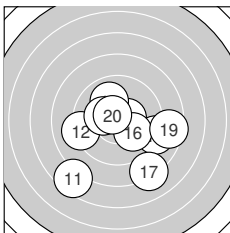

Serie 2: 93.8 (91)

7.5 ↘	9.2 ←	9.1 →	10.5* →	10.0 ↖
10.1 ↘	8.1 ↘	10.2* ←	8.5 →	10.6* ↖

beste Teiler: 87.6 (20.), 115.9 (14.), 176.2 (18.)
Trefferlage: 0.41 mm rechts, 1.45 mm tief
Streuwert: 3.30, horizontal: 3.68, vertikal: 2.88



Ergebnis: **190.9** (181)
 Serien: 96.4 94.5
 Zähler: 8 6 5 1 0 0 0 0 0 0
 Innenzehner: 7
 Weitestе: 752 (15.), 723 (19.), 665 (4.)
 beste Teiler: 68.7 (9.), 102.0 (20.), 132.8 (5.)
 Trefferlage: 0.62 mm rechts, 0.55 mm tief
 Streuwert: 2.90, horizontal: 3.67, vertikal: 1.82

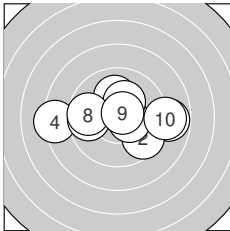
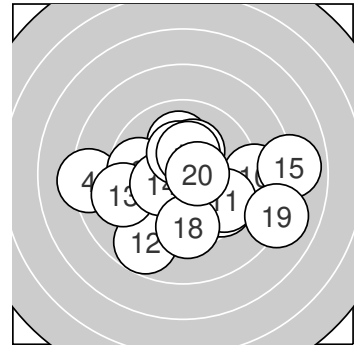

Serie 1: 96.4 (91)

8.8 → 9.6 ↘ 10.1 ↑
 10.2* ↑ 9.7 ← 9.7 ←
 beste Teiler: 68.7 (9.), 132.8 (5.), 177.3 (6.)
 Trefferlage: 0.24 mm rechts, 0.08 mm hoch
 Streuwert: 2.79, horizontal: 3.75, vertikal: 1.20

8.3 ← 10.4* →
 10.7* ↗ 8.9 →

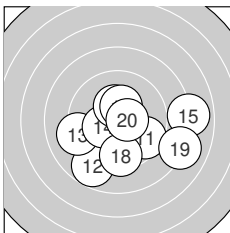

Serie 2: 94.5 (90)

9.6 ↘ 8.8 ↙ 9.2 ←
 10.3* ↑ 10.3* ↑ 9.5 ↓
 beste Teiler: 102.0 (20.), 151.5 (17.), 153.3 (16.)
 Trefferlage: 1.00 mm rechts, 1.19 mm tief
 Streuwert: 3.06, horizontal: 3.75, vertikal: 2.16

10.3* ← 7.9 →
 8.1 → 10.5* →



Ergebnis: **195.9** (187)
Serien: 96.4 99.5
Zähler: 11 7 0 2 0 0 0 0 0 0
Innenzehner: 10
Weiteste: 852 (18.), 771 (4.), 463 (10.)
beste Teiler: 54.1 (3.), 54.2 (16.), 115.2 (2.)
Trefferlage: 0.85 mm links, 0.24 mm hoch
Streuwert: 2.52, horizontal: 3.44, vertikal: 0.92

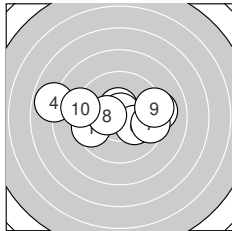
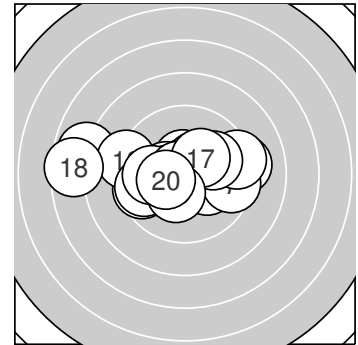

Serie 1: 96.4 (92)

9.6 ← 10.5* ↑ 10.7* ↑ 7.9 ← 9.2 →
 10.2* ↘ 9.5 → 10.4* ← 9.3 → 9.1 ←
beste Teiler: 54.1 (3.), 115.2 (2.), 146.8 (8.)
Trefferlage: 0.31 mm links, 0.38 mm hoch
Streuwert: 2.87, horizontal: 3.93, vertikal: 0.98

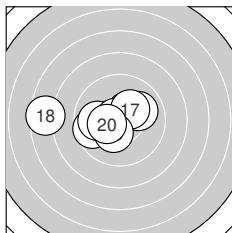

Serie 2: 99.5 (95)

10.5* ← 9.6 ← 10.4* ↗ 10.0 → 9.9 ←
 10.7* ↘ 10.3* ↗ 7.5 ← 10.3* ↘ 10.3* ←
beste Teiler: 54.2 (16.), 125.0 (11.), 129.4 (13.)
Trefferlage: 1.38 mm links, 0.11 mm hoch
Streuwert: 2.21, horizontal: 2.99, vertikal: 0.89



Ergebnis: 201.9 (194)
Serien: 100.5 101.4
Zähler: 14 6 0 0 0 0 0 0 0 0 0
Innenzehner: 11
Weiteste: 474 (3.), 411 (20.), 408 (1.)
beste Teiler: 54.6 (11.), 63.0 (15.), 68.4 (6.)
Trefferlage: 0.50 mm rechts, 0.30 mm tief
Streuwert: 1.74, horizontal: 1.84, vertikal: 1.65

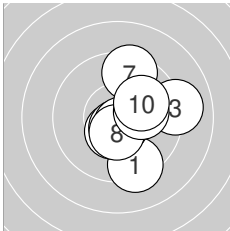
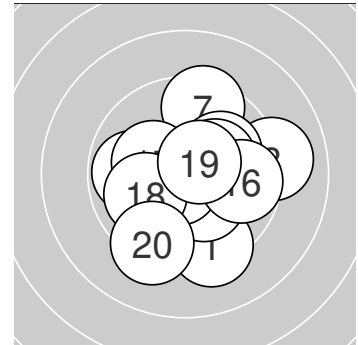

Serie 1: 100.5 (97)

9.3 ↓	10.0 →	9.1 →	10.5* ↓	10.6* ↓
10.7* ↓	9.5 ↑	10.5* ↓	10.2* →	10.1 →

beste Teiler: 68.4 (6.), 85.4 (5.), 121.8 (4.)
Trefferlage: 1.28 mm rechts, 0.07 mm tief
Streuwert: 1.75, horizontal: 1.52, vertikal: 1.95

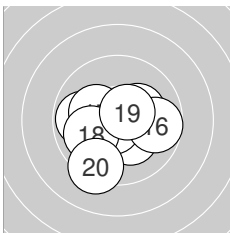

Serie 2: 101.4 (97)

10.7* ↙	9.8 ←	10.2* →	10.3* ↓	10.7* ↙
9.7 →	10.2* ↖	10.0 ←	10.5* ↗	9.3 ↓

beste Teiler: 54.6 (11.), 63.0 (15.), 101.5 (19.)
Trefferlage: 0.26 mm links, 0.53 mm tief
Streuwert: 1.62, horizontal: 1.87, vertikal: 1.33



LG 20 ZR

StandNr: 134

Hellebart, Felix #70606091

Jugend_I_männl.

Wertung

StartNr: 34

04.03.2023 11:14

SG_Schwaz

Ergebnis: **0.0** (0)_{DNS}
Serien:
Zähler: 0 0 0 0 0 0 0 0 0 0 0
Innenzehner: 0
Weiteste:
~~beste Teiler~~Schütze ist nicht zum Wettkampf angetreten
Trefferlage: 0.00 mm , 0.00 mm
Streuwert:

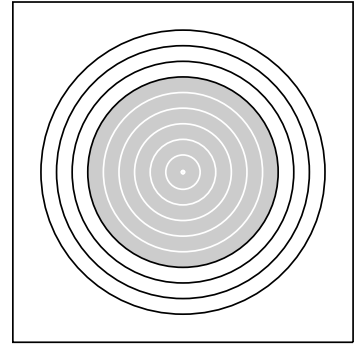

Ergebnis: **194.8** (183)
 Serien: 96.7 98.1
 Zähler: 8 9 1 2 0 0 0 0 0 0 0
 Innenzehner: 8
 Weitesten: 830 (5.), 800 (7.), 594 (20.)
 beste Teiler: 55.0 (10.), 100.1 (4.), 102.0 (17.)
 Trefferlage: 1.07 mm links, 0.94 mm hoch
 Streuwert: 2.49, horizontal: 3.35, vertikal: 1.09

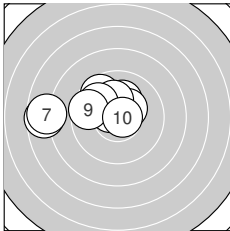
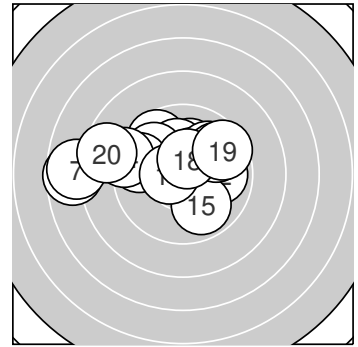

Serie 1: 96.7 (91)

9.7 ↘ 10.2* ↑ 10.4* ↗
 10.2* ↑ 7.8 ← 9.9 ↘
 beste Teiler: 55.0 (10.), 100.1 (4.), 149.4 (3.)
 Trefferlage: 2.28 mm links, 1.07 mm hoch
 Streuwert: 2.48, horizontal: 3.38, vertikal: 0.91

10.6* ↘ 7.6 ←
 9.6 ← 10.7* →

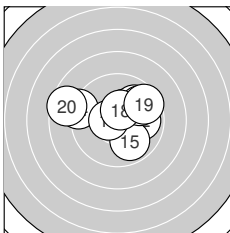

Serie 2: 98.1 (92)

10.3* ↗ 9.9 → 9.9 ↗
 9.8 ↗ 10.5* ← 10.5* ↑
 beste Teiler: 102.0 (17.), 119.1 (18.), 151.7 (11.)
 Trefferlage: 0.12 mm rechts, 0.81 mm hoch
 Streuwert: 2.31, horizontal: 3.01, vertikal: 1.28

9.1 ← 9.9 ↘
 9.6 ↗ 8.6 ←



Ergebnis: **195.5** (188)
 Serien: 97.1 98.4
 Zähler: 11 7 1 1 0 0 0 0 0 0 0
 Innenzehner: 4
 Weitestе: 810 (19.), 521 (5.), 498 (8.)
 beste Teiler: 37.0 (15.), 48.2 (16.), 79.7 (3.)
 Trefferlage: 0.30 mm links, 0.50 mm tief
 Streuwert: 2.47, horizontal: 3.32, vertikal: 1.09

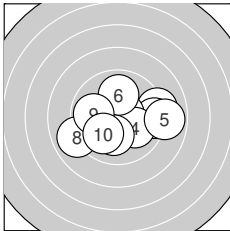
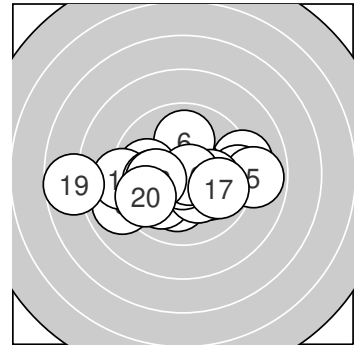

Serie 1: 97.1 (94)

9.2 → 9.3 → 10.6* ↗
 10.0 ↑ 10.1 ↓ 9.0 ←
 beste Teiler: 79.7 (3.), 203.3 (7.), 222.9 (4.)
 Trefferlage: 0.72 mm rechts, 0.32 mm tief
 Streuwert: 2.49, horizontal: 3.19, vertikal: 1.48

10.1 ↘ 8.9 →
 9.9 ← 10.0 ↙

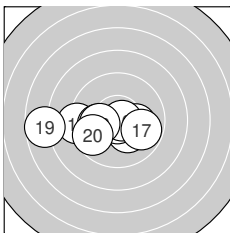

Serie 2: 98.4 (94)

9.1 ← 10.1 → 10.0 ←
 10.8* → 9.8 ↘ 10.1 ←
 beste Teiler: 37.0 (15.), 48.2 (16.), 175.5 (14.)
 Trefferlage: 1.33 mm links, 0.68 mm tief
 Streuwert: 2.34, horizontal: 3.28, vertikal: 0.51

10.3* ↘ 10.8* ↓
 7.7 ← 9.7 ↙



Ergebnis: **180.2** (170)
 Serien: 90.1 90.1
 Zähler: 4 9 2 3 2 0 0 0 0 0 0
 Innenzehner: 2
 Weitesten: 1147 (12.), 1041 (2.), 907 (15.)
 beste Teiler: 98.3 (20.), 162.1 (17.), 223.0 (14.)
 Trefferlage: 0.59 mm links, 0.07 mm hoch
 Streuwert: 4.12, horizontal: 5.41, vertikal: 2.16

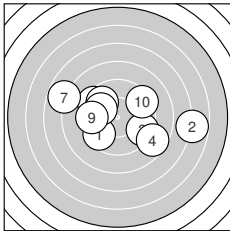
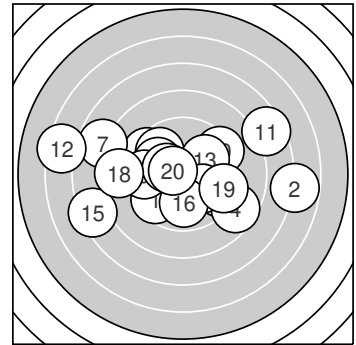

Serie 1: 90.1 (84)

9.6 ↙	6.8 →	9.4 ↘	8.6 ↘	9.4 ↖
9.8 ↘	7.8 ↖	9.9 ↖	9.5 ←	9.3 ↗

beste Teiler: 257.5 (8.), 297.0 (6.), 345.4 (1.)
 Trefferlage: 0.07 mm rechts, 0.17 mm hoch
 Streuwert: 4.02, horizontal: 5.26, vertikal: 2.16

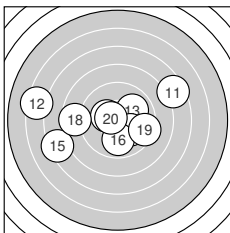

Serie 2: 90.1 (86)

7.5 ↗	6.4 ←	10.0 ↗	10.1 ↘	7.3 ←
9.9 ↓	10.3* ↖	8.6 ←	9.4 ↘	10.6* ↖

beste Teiler: 98.3 (20.), 162.1 (17.), 223.0 (14.)
 Trefferlage: 1.25 mm links, 0.01 mm tief
 Streuwert: 4.38, horizontal: 5.76, vertikal: 2.28



Ergebnis: **185.7** (176)
 Serien: 92.3 93.4
 Zähler: 6 8 3 2 1 0 0 0 0 0 0
 Innenzehner: 4
 Weitester: 1220 (14.), 985 (7.), 781 (1.)
 beste Teiler: 111.0 (3.), 123.6 (4.), 140.9 (16.)
 Trefferlage: 1.71 mm rechts, 1.00 mm hoch
 Streuwert: 3.38, horizontal: 4.46, vertikal: 1.73

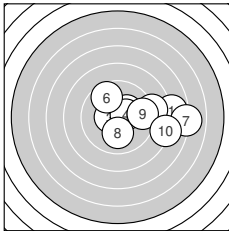
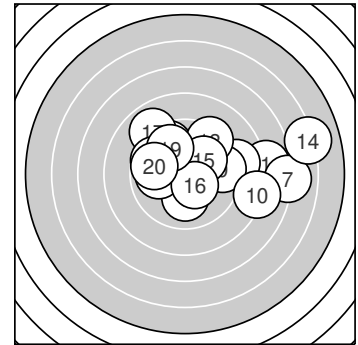

Serie 1: 92.3 (88)

7.8 →	10.3* ↗	10.5* ←	10.5* →	8.9 →
9.6 ↘	7.0 →	10.1 ↓	9.5 →	8.1 ↘

beste Teiler: 111.0 (3.), 123.6 (4.), 162.8 (2.)
 Trefferlage: 3.28 mm rechts, 0.21 mm hoch
 Streuwert: 2.99, horizontal: 3.95, vertikal: 1.50

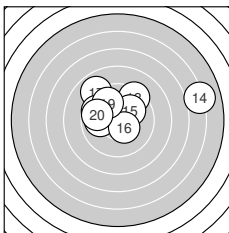

Serie 2: 93.4 (88)

9.5 ↘	9.9 ←	9.3 ↗	6.1 →	10.1 ↗
10.4* ↘	8.9 ↘	9.7 ↖	9.8 ↘	9.7 ↖

beste Teiler: 140.9 (16.), 225.8 (15.), 251.2 (12.)
 Trefferlage: 0.15 mm rechts, 1.80 mm hoch
 Streuwert: 3.44, horizontal: 4.58, vertikal: 1.62



Ergebnis: 180.8 (172)
Serien: 89.4 91.4
Zähler: 7 5 3 3 2 0 0 0 0 0 0
Innenzehner: 4
Weiteste: 1149 (6.), 1016 (11.), 915 (15.)
beste Teiler: 74.6 (9.), 131.1 (5.), 169.6 (20.)
Trefferlage: 0.27 mm links, 0.92 mm hoch
Streuwert: 4.07, horizontal: 5.34, vertikal: 2.14

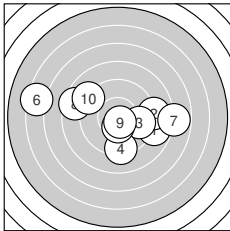
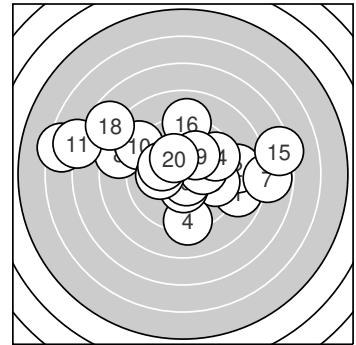

Serie 1: 89.4 (84)

8.8 → 8.9 → 9.7 → 9.2 ↓ 10.4* ↓
 6.4 ← 7.8 → 8.5 ← 10.7* ↓ 9.0 ↖

beste Teiler: 74.6 (9.), 131.1 (5.), 309.7 (3.)
Trefferlage: 0.05 mm rechts, 0.15 mm tief
Streuwert: 4.35, horizontal: 5.76, vertikal: 2.13

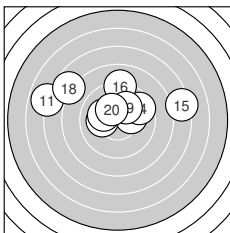

Serie 2: 91.4 (88)

6.9 ← 10.2* → 10.1 ← 9.6 → 7.3 →
 9.1 ↑ 10.1 ↖ 7.7 ↖ 10.1 ↗ 10.3* ↖

beste Teiler: 169.6 (20.), 189.8 (12.), 205.9 (17.)
Trefferlage: 0.61 mm links, 2.00 mm hoch
Streuwert: 3.82, horizontal: 5.16, vertikal: 1.61



Ergebnis: **209.2** (200)
 Serien: 105.8 103.4
 Zähler: 20 0 0 0 0 0 0 0 0 0 0
 Innenzehner: 16
 Weitester: 231 (16.), 222 (15.), 219 (20.)
 beste Teiler: 4.0 (11.), 14.5 (3.), 18.8 (2.)
 Trefferlage: 0.64 mm links, 0.04 mm hoch
 Streuwert: 0.91, horizontal: 1.03, vertikal: 0.78

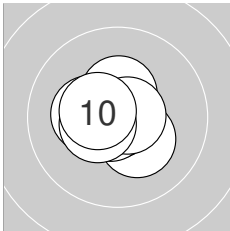
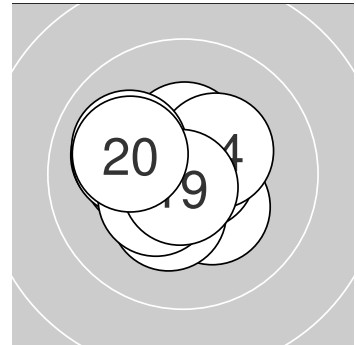

Serie 1: 105.8 (100)

10.3* ↘	10.9* ✓	10.9* ↑	10.3* ←	10.7* ✓
10.6* ↖	10.4* ↑	10.7* →	10.5* ←	10.5* ←

beste Teiler: 14.5 (3.), 18.8 (2.), 52.8 (5.)
 Trefferlage: 0.33 mm links, 0.05 mm hoch
 Streuwert: 0.77, horizontal: 0.85, vertikal: 0.68

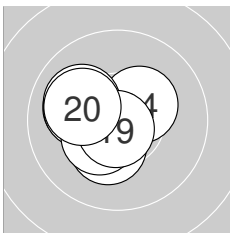

Serie 2: 103.4 (100)

10.9* →	10.3* ↓	10.5* ✓	10.3* ↗	10.1* ↖
10.0* ↖	10.1* ↖	10.4* ✓	10.7* ↓	10.1* ↖

beste Teiler: 4.0 (11.), 52.1 (19.), 118.4 (13.)
 Trefferlage: 0.96 mm links, 0.04 mm hoch
 Streuwert: 1.03, horizontal: 1.15, vertikal: 0.90



Ergebnis: **191.1** (183)
 Serien: 92.7 98.4
 Zähler: 7 9 4 0 0 0 0 0 0 0 0
 Innenzehner: 4
 Weitester: 746 (8.), 702 (14.), 568 (5.)
 beste Teiler: 5.0 (16.), 110.4 (18.), 142.1 (19.)
 Trefferlage: 1.25 mm rechts, 0.47 mm hoch
 Streuwert: 2.70, horizontal: 3.60, vertikal: 1.28

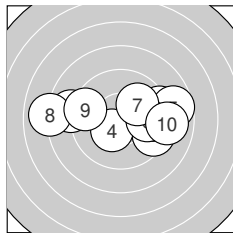
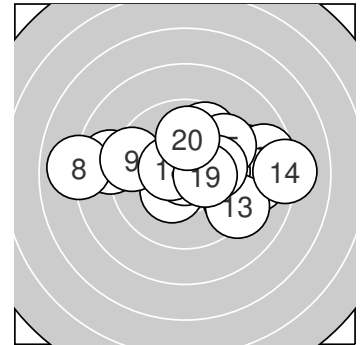

Serie 1: 92.7 (89)

8.8 ← 9.4 ↘ 9.2 →
 9.8 → 10.0 ↗ 8.0 ←
 beste Teiler: 148.2 (4.), 236.5 (7.), 281.2 (6.)
 Trefferlage: 0.52 mm rechts, 0.30 mm hoch
 Streuwert: 3.34, horizontal: 4.59, vertikal: 1.10

10.4* ↙ 8.7 →
 9.4 ← 9.0 →

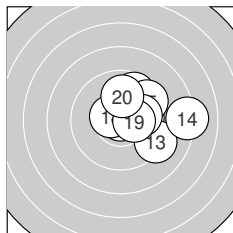

Serie 2: 98.4 (94)

9.7 ↗ 10.0 → 9.2 ↘
 10.9* ↑ 10.1 → 10.5* ←
 beste Teiler: 5.0 (16.), 110.4 (18.), 142.1 (19.)
 Trefferlage: 1.99 mm rechts, 0.63 mm hoch
 Streuwert: 1.91, horizontal: 2.26, vertikal: 1.48

8.1 → 9.6 ↗
 10.4* → 9.9 ↑



Ergebnis: 186.7 (179)
Serien: 92.6 94.1
Zähler: 6 10 2 1 1 0 0 0 0 0 0
Innenzehner: 4
Weiteste: 1009 (2.), 960 (1.), 742 (10.)
beste Teiler: 50.9 (13.), 53.1 (9.), 114.6 (6.)
Trefferlage: 0.53 mm links, 1.27 mm tief
Streuwert: 3.37, horizontal: 4.25, vertikal: 2.16

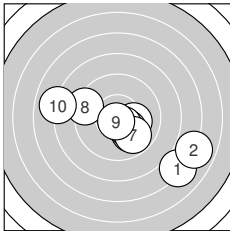
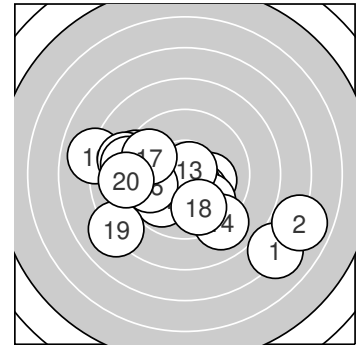

Serie 1: 92.6 (89)

7.1 ↘ 6.9 ↘ 10.1 → 10.0 ↘ 10.2* ↘
 10.5* ↘ 9.8 ↘ 9.3 ← 10.7* ↓ 8.0 ←
beste Teiler: 53.1 (9.), 114.6 (6.), 183.4 (5.)
Trefferlage: 1.23 mm rechts, 1.47 mm tief
Streuwert: 3.75, horizontal: 4.77, vertikal: 2.30

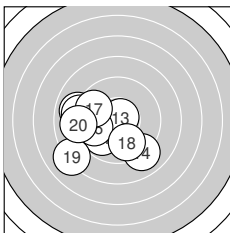

Serie 2: 94.1 (90)

9.8 ↙ 9.0 ← 10.8* ↗ 9.0 ↘ 9.1 ←
 9.8 ← 9.7 ↖ 9.8 ↘ 8.1 ↙ 9.0 ←
beste Teiler: 50.9 (13.), 276.0 (11.), 290.4 (18.)
Trefferlage: 2.30 mm links, 1.06 mm tief
Streuwert: 2.53, horizontal: 2.89, vertikal: 2.10



Ergebnis: **201.7** (193)
 Serien: 102.0 99.7
 Zähler: 13 7 0 0 0 0 0 0 0 0
 Innenzehner: 10
 Weitestе: 391 (19.), 378 (11.), 377 (18.)
 beste Teiler: 33.5 (10.), 41.4 (20.), 103.1 (7.)
 Trefferlage: 1.04 mm links, 0.39 mm hoch
 Streuwert: 1.55, horizontal: 1.81, vertikal: 1.24

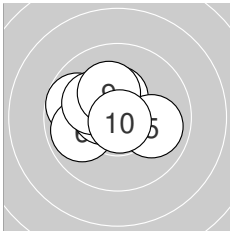
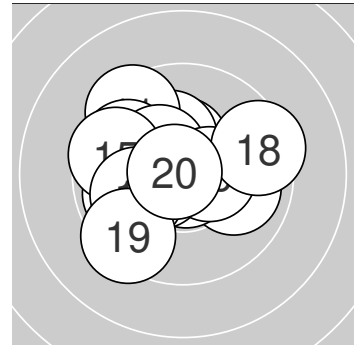

Serie 1: 102.0 (98)

10.2* ←	10.0 ←	9.8 ←	10.4* ↑	10.0 →
9.9 ←	10.5* ←	10.2* ←	10.2* ↖	10.8* ↘

beste Teiler: 33.5 (10.), 103.1 (7.), 141.1 (4.)
 Trefferlage: 1.02 mm links, 0.46 mm hoch
 Streuwert: 1.27, horizontal: 1.58, vertikal: 0.87

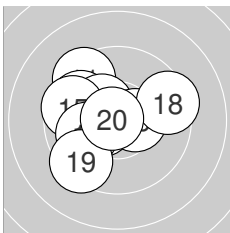

Serie 2: 99.7 (95)

9.4 ↘	9.8 ↘	10.5* ←	10.3* ↘	9.6 ←
10.5* →	10.0 ←	9.4 →	9.4 ↙	10.8* ←

beste Teiler: 41.4 (20.), 118.2 (13.), 125.0 (16.)
 Trefferlage: 1.07 mm links, 0.32 mm hoch
 Streuwert: 1.85, horizontal: 2.10, vertikal: 1.57

