

Ergebnis: **195.2** (185)
 Serien: 99.6 95.6
 Zähler: 6 13 1 0 0 0 0 0 0 0
 Innenzehner: 4
 Weitesten: 644 (12.), 410 (15.), 399 (13.)
 beste Teiler: 145.7 (10.), 150.1 (9.), 160.3 (19.)
 Trefferlage: 0.02 mm links, 1.80 mm tief
 Streuwert: 1.92, horizontal: 2.35, vertikal: 1.37

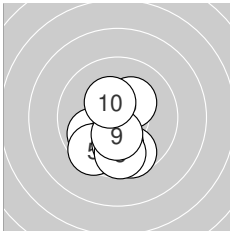
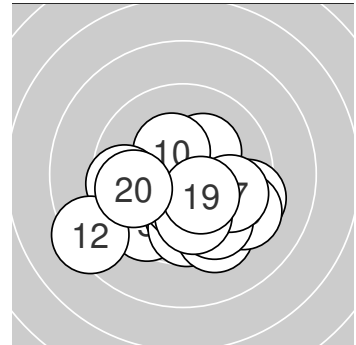

Serie 1: 99.6 (94)

9.6 ↘	9.9 ↙	9.8 ↘	9.9 ↘	9.6 ↙
10.3* ↗	10.0 ↓	9.7 ↓	10.4* ↓	10.4* ↖

beste Teiler: 145.7 (10.), 150.1 (9.), 172.7 (6.)
 Trefferlage: 0.42 mm links, 1.67 mm tief
 Streuwert: 1.44, horizontal: 1.17, vertikal: 1.66

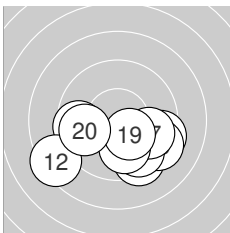

Serie 2: 95.6 (91)

9.6 ←	8.4 ↙	9.4 →	9.4 ↘	9.3 ↘
9.6 ↘	9.8 →	10.0 ↓	10.3* ↘	9.8 ←

beste Teiler: 160.3 (19.), 248.6 (18.), 295.4 (17.)
 Trefferlage: 0.36 mm rechts, 1.93 mm tief
 Streuwert: 2.36, horizontal: 3.15, vertikal: 1.07



Ergebnis: **203.2** (193)
 Serien: 103.3 99.9
 Zähler: 15 4 0 1 0 0 0 0 0 0
 Innenzehner: 12
 Weitester: 814 (19.), 445 (12.), 305 (18.)
 beste Teiler: 31.2 (6.), 31.7 (16.), 51.5 (9.)
 Trefferlage: 1.03 mm links, 0.66 mm hoch
 Streuwert: 1.69, horizontal: 2.11, vertikal: 1.11

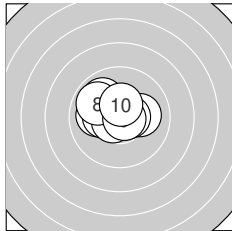
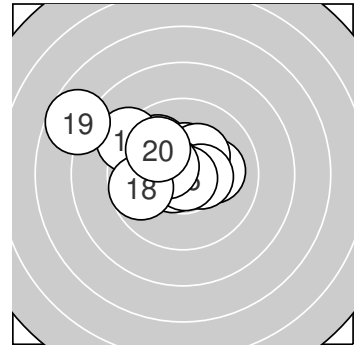

Serie 1: 103.3 (98)

10.0 ← 10.1 → 10.3* ← 10.6* → 9.9 ↘
 10.8* ↑ 10.6* ↙ 9.9 ↘ 10.7* → 10.4* ↑
 beste Teiler: 31.2 (6.), 51.5 (9.), 80.7 (7.)
 Trefferlage: 0.50 mm links, 0.48 mm hoch
 Streuwert: 1.18, horizontal: 1.48, vertikal: 0.76

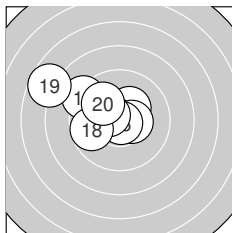

Serie 2: 99.9 (95)

10.3* ↗ 9.2 ↘ 10.6* ← 10.4* → 10.7* ←
 10.8* ↘ 10.5* ↘ 9.7 ← 7.7 ↘ 10.0 ↘
 beste Teiler: 31.7 (16.), 52.0 (15.), 86.3 (13.)
 Trefferlage: 1.57 mm links, 0.84 mm hoch
 Streuwert: 2.06, horizontal: 2.56, vertikal: 1.39



Ergebnis: 201.4 (194)
Serien: 99.8 101.6
Zähler: 16 3 0 1 0 0 0 0 0 0
Innenzehner: 11
Weiteste: 800 (10.), 380 (11.), 375 (17.)
beste Teiler: 51.1 (19.), 89.1 (12.), 113.4 (13.)
Trefferlage: 0.25 mm rechts, 0.71 mm tief
Streuwert: 1.89, horizontal: 2.53, vertikal: 0.87

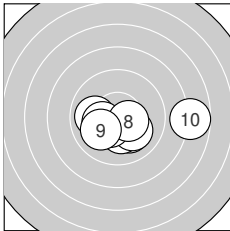
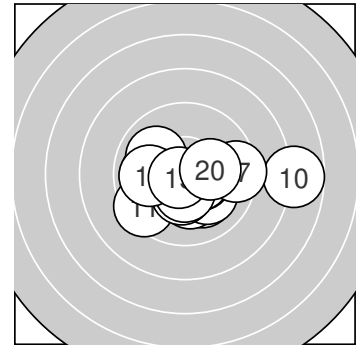

Serie 1: 99.8 (97)

10.1 ↘	10.5* ↘	10.2* ↓	10.1 ↘	10.0 ←
10.4* ↙	10.2* ←	10.5* →	10.0 ↙	7.8 →

beste Teiler: 121.2 (2.), 124.9 (8.), 136.2 (6.)
Trefferlage: 0.61 mm rechts, 0.94 mm tief
Streuwert: 2.15, horizontal: 2.97, vertikal: 0.65

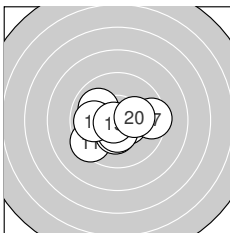

Serie 2: 101.6 (97)

9.4 ↙	10.6* ↘	10.5* →	10.4* ↓	10.4* ↓
10.0 ↖	9.5 →	9.9 ←	10.7* ↙	10.2* →

beste Teiler: 51.1 (19.), 89.1 (12.), 113.4 (13.)
Trefferlage: 0.11 mm links, 0.47 mm tief
Streuwert: 1.65, horizontal: 2.09, vertikal: 1.03



Ergebnis: 199.8 (190)
Serien: 101.5 98.3
Zähler: 10 10 0 0 0 0 0 0 0 0
Innenzehner: 8
Weiteste: 415 (13.), 409 (20.), 402 (16.)
beste Teiler: 47.0 (4.), 59.0 (7.), 90.5 (18.)
Trefferlage: 0.68 mm links, 0.09 mm hoch
Streuwert: 1.93, horizontal: 2.51, vertikal: 1.07

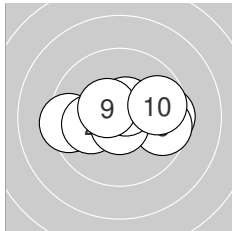
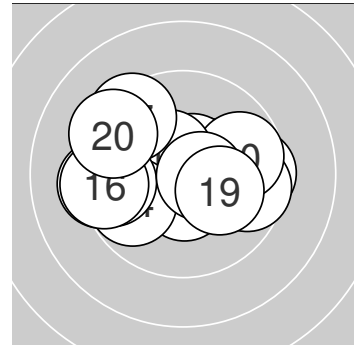

Serie 1: 101.5 (96)

9.4 ←	10.1 ←	9.6 →	10.8* →	10.5* ↗
9.6 →	10.7* ↓	10.6* ↗	10.5* ↖	9.7 →

beste Teiler: 47.0 (4.), 59.0 (7.), 94.5 (8.)
Trefferlage: 0.46 mm rechts, 0.08 mm hoch
Streuwert: 1.74, horizontal: 2.38, vertikal: 0.63

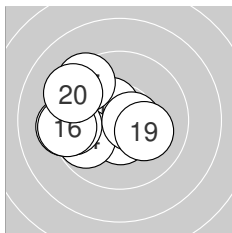

Serie 2: 98.3 (94)

10.5* ↓	10.5* ↖	9.3 ←	9.8 ←	9.5 ←
9.3 ←	9.4 ↖	10.6* →	10.1 →	9.3 ↖

beste Teiler: 90.5 (18.), 114.2 (11.), 125.4 (12.)
Trefferlage: 1.82 mm links, 0.10 mm hoch
Streuwert: 1.84, horizontal: 2.19, vertikal: 1.41



Ergebnis: 207.9 (198)
Serien: 103.5 104.4 0.0
Zähler: 18 2 0 0 0 0 0 0 0 2
Innenzehner: 17
Weiteste: 308 (16.), 268 (4.), 203 (6.)
beste Teiler: 59.0 (20.), 70.3 (12.), 76.6 (15.)
Trefferlage: 0.24 mm links, 0.49 mm hoch
Streuwert: 1.01, horizontal: 1.23, vertikal: 0.73

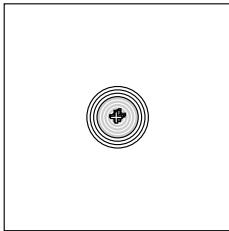
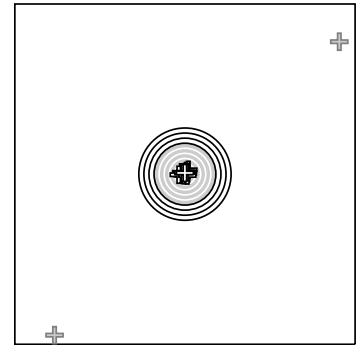

Serie 1: 103.5 (99)

10.6* ↘	10.6* ←	10.3* ↗	9.9 ↗	10.3* ↗
10.1 ↘	10.3* ↘	10.5* ↑	10.4* ↘	10.5* ←

beste Teiler: 89.6 (2.), 95.4 (1.), 104.5 (10.)
Trefferlage: 0.30 mm links, 0.89 mm hoch
Streuwert: 0.95, horizontal: 1.18, vertikal: 0.64

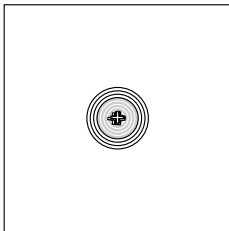

Serie 2: 104.4 (99)

10.4* ←	10.7* ↑	10.3* →	10.6* ↙	10.6* ↘
9.7 ←	10.4* ↘	10.5* ↗	10.5* ↘	10.7* ↑

beste Teiler: 59.0 (20.), 70.3 (12.), 76.6 (15.)
Trefferlage: 0.19 mm links, 0.10 mm hoch
Streuwert: 1.03, horizontal: 1.33, vertikal: 0.60

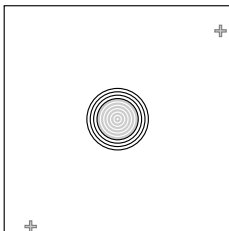

Serie 3: 0.0 (0)

0.0+ ↙ <small>AST,NSC</small>	0.0+ ↗ <small>AST,NSC</small>
----------------------------------	----------------------------------

beste Teiler:
Trefferlage: 0.00 mm , 0.00 mm
Streuwert: 0.00, horizontal: 0.00, vertikal: 0.00

AST – Treffer wurde nach Ende der Schießzeit abgegeben
NSC – Treffer wurde vermessen, geht aber nicht in die Wertung ein



Ergebnis: **183.3** (174)
 Serien: 91.1 92.2
 Zähler: 6 7 3 3 1 0 0 0 0 0 0
 Innenzehner: 5
 Weitestе: 1100 (18.), 786 (3.), 780 (17.)
 beste Teiler: 74.8 (20.), 78.9 (16.), 114.0 (7.)
 Trefferlage: 0.98 mm links, 0.87 mm tief
 Streuwert: 3.67, horizontal: 4.78, vertikal: 2.04

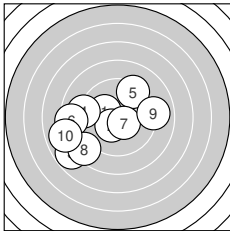
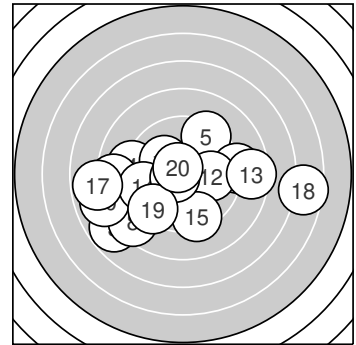

Serie 1: 91.1 (87)

10.2* ↖ 10.4* ↙ 7.8 ↘
 8.4 ← 10.5* ↘ 8.5 ↘
 beste Teiler: 114.0 (7.), 140.8 (2.), 194.5 (1.)
 Trefferlage: 2.35 mm links, 0.83 mm tief
 Streuwert: 3.37, horizontal: 4.05, vertikal: 2.50

9.1 ← 9.3 ↗
 9.0 → 7.9 ←

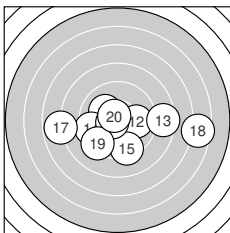

Serie 2: 92.2 (87)

10.1 ↖ 9.9 → 8.5 →
 10.6* ← 7.8 ← 6.6 →
 beste Teiler: 74.8 (20.), 78.9 (16.), 210.2 (11.)
 Trefferlage: 0.39 mm rechts, 0.91 mm tief
 Streuwert: 3.88, horizontal: 5.25, vertikal: 1.59

9.4 ← 9.3 ↓
 9.3 ↙ 10.7* ↘



Ergebnis: **204.8** (194)
 Serien: 102.8 102.0
 Zähler: 14 6 0 0 0 0 0 0 0 0 0
 Innenzehner: 13
 Weitestе: 380 (13.), 336 (17.), 319 (14.)
 beste Teiler: 52.0 (4.), 57.3 (18.), 66.0 (2.)
 Trefferlage: 0.36 mm rechts, 0.28 mm tief
 Streuwert: 1.44, horizontal: 1.83, vertikal: 0.91

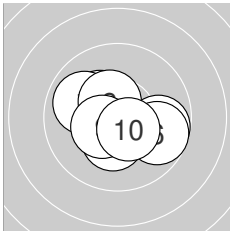
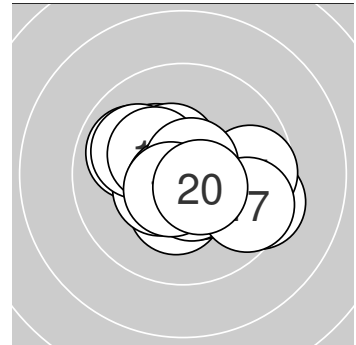

Serie 1: 102.8 (97)

10.3* ↖	10.7* ↙	9.8 →	10.7* ↓	10.3* ↓
9.7 →	9.9 ↖	10.5* ↖	10.4* ↙	10.5* ↘

beste Teiler: 52.0 (4.), 66.0 (2.), 114.7 (10.)
 Trefferlage: 0.03 mm rechts, 0.26 mm tief
 Streuwert: 1.39, horizontal: 1.70, vertikal: 0.98

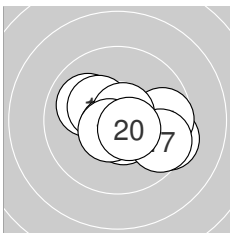

Serie 2: 102.0 (97)

10.0 ↖	10.3* ↖	9.4 →	9.7 →	10.7* ↙
10.5* ↓	9.6 →	10.7* ↗	10.6* ↙	10.5* ↘

beste Teiler: 57.3 (18.), 70.1 (15.), 91.8 (19.)
 Trefferlage: 0.69 mm rechts, 0.30 mm tief
 Streuwert: 1.53, horizontal: 1.98, vertikal: 0.89



Ergebnis: **180.3** (172)
 Serien: 91.7 88.6
 Zähler: 5 7 6 1 0 0 1 0 0 0 0
 Innenzehner: 3
 Weitester: 1573 (20.), 813 (18.), 718 (12.)
 beste Teiler: 114.5 (16.), 114.6 (13.), 171.3 (15.)
 Trefferlage: 1.02 mm rechts, 1.33 mm tief
 Streuwert: 4.03, horizontal: 5.20, vertikal: 2.34

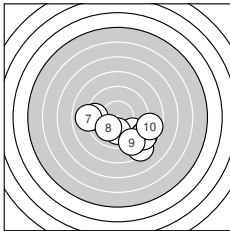
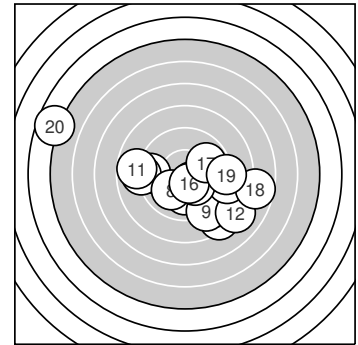

Serie 1: 91.7 (88)

9.6 ↘	10.0 ↓	8.4 ↘	8.8 ↘	9.4 ←
8.8 ↘	9.0 ←	10.0 ↗	9.0 ↘	8.7 →

beste Teiler: 235.0 (2.), 236.0 (8.), 348.1 (1.)
 Trefferlage: 1.26 mm rechts, 2.37 mm tief
 Streuwert: 2.85, horizontal: 3.68, vertikal: 1.66

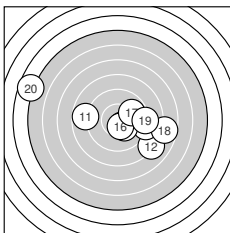

Serie 2: 88.6 (84)

8.8 ←	8.1 ↘	10.5* ↘	9.0 →	10.3* ↘
10.5* ↘	9.9 ↗	7.7 →	9.1 →	4.7 ←

beste Teiler: 114.5 (16.), 114.6 (13.), 171.3 (15.)
 Trefferlage: 0.77 mm rechts, 0.29 mm tief
 Streuwert: 4.99, horizontal: 6.58, vertikal: 2.53



Ergebnis: 199.9 (193)
Serien: 100.8 99.1
Zähler: 13 7 0 0 0 0 0 0 0 0 0
Innenzehner: 5
Weiteste: 441 (17.), 356 (2.), 345 (10.)
beste Teiler: 62.8 (9.), 68.8 (18.), 104.6 (3.)
Trefferlage: 0.25 mm rechts, 0.57 mm hoch
Streuwert: 1.81, horizontal: 2.27, vertikal: 1.17

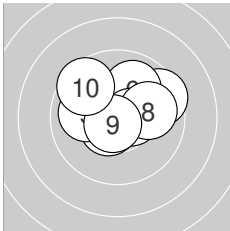
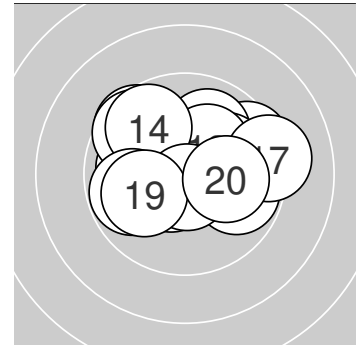

Serie 1: 100.8 (98)

10.0 →	9.5 →	10.5* ↘	10.0 ↖	10.0 ←
10.0 ↗	10.5* →	10.0 →	10.7* ↘	9.6 ↖

beste Teiler: 62.8 (9.), 104.6 (3.), 105.0 (7.)
Trefferlage: 0.18 mm rechts, 0.74 mm hoch
Streuwert: 1.67, horizontal: 2.12, vertikal: 1.05

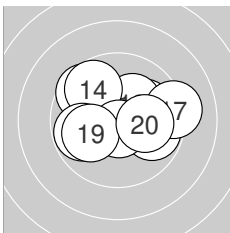

Serie 2: 99.1 (95)

9.6 ↖	10.0 →	10.2* ↗	9.7 ↖	9.8 ←
9.8 →	9.2 →	10.7* ↓	10.0 ←	10.1 →

beste Teiler: 68.8 (18.), 181.0 (13.), 214.5 (20.)
Trefferlage: 0.32 mm rechts, 0.39 mm hoch
Streuwert: 2.01, horizontal: 2.52, vertikal: 1.32



Ergebnis: **199.3** (190)
 Serien: 97.2 102.1
 Zähler: 10 10 0 0 0 0 0 0 0 0 0
 Innenzehner: 8
 Weitester: 485 (10.), 448 (8.), 420 (15.)
 beste Teiler: 7.2 (12.), 35.3 (2.), 71.0 (16.)
 Trefferlage: 0.39 mm rechts, 1.00 mm tief
 Streuwert: 1.93, horizontal: 2.46, vertikal: 1.20

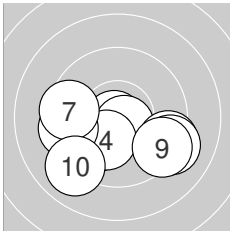
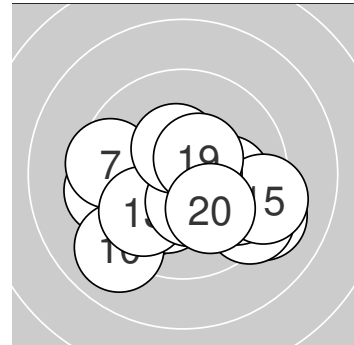

Serie 1: 97.2 (93)

9.9 ↙	10.8* ↙	10.6* ↘	10.2* ↙	9.3 ↘
9.4 ←	9.5 ←	9.2 ↘	9.3 ↘	9.0 ↙

beste Teiler: 35.3 (2.), 78.2 (3.), 190.5 (4.)
 Trefferlage: 0.18 mm links, 1.45 mm tief
 Streuwert: 2.30, horizontal: 3.02, vertikal: 1.19

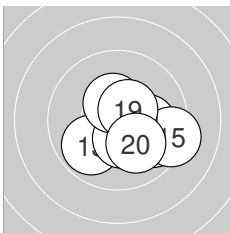

Serie 2: 102.1 (97)

9.8 ↘	10.9* ↑	9.9 ↙	10.1 →	9.3 ↘
10.7* →	10.4* ↓	10.4* ↑	10.5* ↗	10.1 ↘

beste Teiler: 7.2 (12.), 71.0 (16.), 111.0 (19.)
 Trefferlage: 0.97 mm rechts, 0.56 mm tief
 Streuwert: 1.42, horizontal: 1.69, vertikal: 1.09



Ergebnis: **190.4** (182)
 Serien: 95.1 95.3
 Zähler: 7 9 3 1 0 0 0 0 0 0 0
 Innenzehner: 7
 Weitesten: 794 (18.), 682 (7.), 671 (3.)
 beste Teiler: 124.2 (17.), 125.0 (2.), 140.2 (20.)
 Trefferlage: 0.12 mm rechts, 1.12 mm tief
 Streuwert: 2.86, horizontal: 3.86, vertikal: 1.23

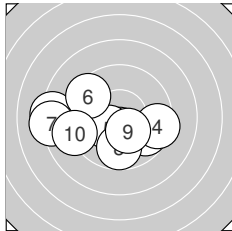
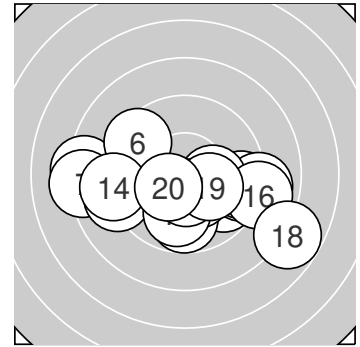

Serie 1: 95.1 (91)

9.7 ↘ 10.5* ↓ 8.3 ←
 9.4 ↖ 8.2 ← 9.8 ↓
 beste Teiler: 125.0 (2.), 149.9 (5.), 159.0 (9.)
 Trefferlage: 1.50 mm links, 0.89 mm tief
 Streuwert: 2.77, horizontal: 3.67, vertikal: 1.35

9.4 → 10.4* ↙
 10.3* ↘ 9.1 ←

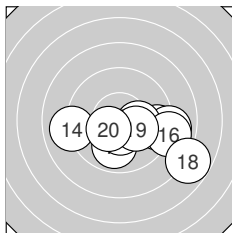

Serie 2: 95.3 (91)

9.4 → 9.0 → 10.2* →
 8.9 → 10.5* ↓ 7.8 ↘
 beste Teiler: 124.2 (17.), 140.2 (20.), 183.3 (19.)
 Trefferlage: 1.75 mm rechts, 1.36 mm tief
 Streuwert: 2.58, horizontal: 3.47, vertikal: 1.12

9.0 ← 9.9 ↓
 10.2* ↘ 10.4* ↙



Ergebnis: **195.3** (185)
 Serien: 96.8 98.5
 Zähler: 9 8 2 1 0 0 0 0 0 0
 Innenzehner: 8
 Weitester: 919 (16.), 557 (2.), 535 (5.)
 beste Teiler: 13.0 (13.), 64.0 (14.), 84.1 (12.)
 Trefferlage: 0.39 mm links, 0.24 mm tief
 Streuwert: 2.59, horizontal: 3.47, vertikal: 1.17

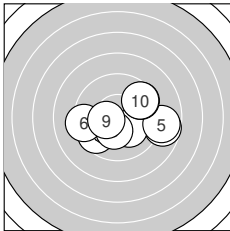
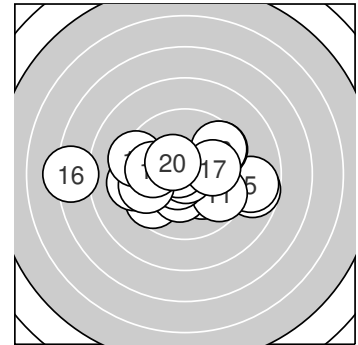

Serie 1: 96.8 (92)

9.6 ↙	8.7 →	10.3* ↘	10.2* ↘	8.8 →
9.3 ←	9.6 ↗	10.3* ↓	10.4* ←	9.6 ↗

beste Teiler: 140.9 (9.), 154.4 (3.), 166.3 (8.)
 Trefferlage: 0.80 mm rechts, 0.51 mm tief
 Streuwert: 2.50, horizontal: 3.24, vertikal: 1.42

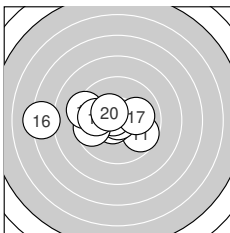

Serie 2: 98.5 (93)

9.7 ↘	10.6* ↙	10.9* ↘	10.7* ↘	9.7 ←
7.3 ←	10.0 →	9.3 ↖	9.9 ←	10.4* ↖

beste Teiler: 13.0 (13.), 64.0 (14.), 84.1 (12.)
 Trefferlage: 1.58 mm links, 0.02 mm hoch
 Streuwert: 2.49, horizontal: 3.42, vertikal: 0.85



Ergebnis: **199.0** (189)
 Serien: 99.4 99.6
 Zähler: 9 11 0 0 0 0 0 0 0 0 0
 Innenzehner: 6
 Weitestе: 468 (20.), 429 (8.), 400 (14.)
 beste Teiler: 51.4 (13.), 103.3 (2.), 122.1 (12.)
 Trefferlage: 0.79 mm rechts, 0.51 mm tief
 Streuwert: 1.87, horizontal: 2.20, vertikal: 1.48

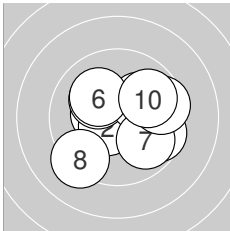
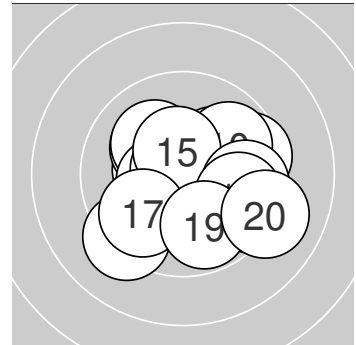

Serie 1: 99.4 (95)

10.4* ←	10.5* ↙	9.6 →	10.1 ↖	10.1 ↗
10.1 ↘	9.9 ↘	9.2 ↙	9.6 →	9.9 ↗

beste Teiler: 103.3 (2.), 139.0 (1.), 201.8 (4.)
 Trefferlage: 0.45 mm rechts, 0.00 mm
 Streuwert: 1.97, horizontal: 2.27, vertikal: 1.63

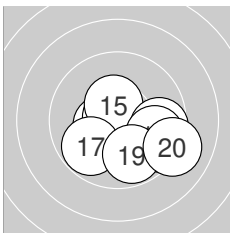

Serie 2: 99.6 (94)

10.4* ↓	10.5* ←	10.7* ↖	9.4 →	10.5* ↑
9.7 →	9.8 ↙	9.7 →	9.8 ↓	9.1 ↘

beste Teiler: 51.4 (13.), 122.1 (12.), 125.8 (15.)
 Trefferlage: 1.13 mm rechts, 1.02 mm tief
 Streuwert: 1.76, horizontal: 2.19, vertikal: 1.18



Ergebnis: **201.3** (193)
 Serien: 100.1 101.2
 Zähler: 13 7 0 0 0 0 0 0 0 0
 Innenzehner: 9
 Weitesten: 425 (7.), 376 (3.), 360 (17.)
 beste Teiler: 29.4 (18.), 58.5 (13.), 94.6 (1.)
 Trefferlage: 0.25 mm links, 0.25 mm tief
 Streuwert: 1.74, horizontal: 2.25, vertikal: 0.98

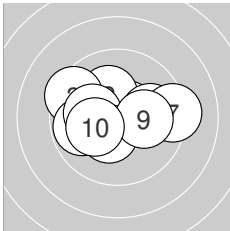
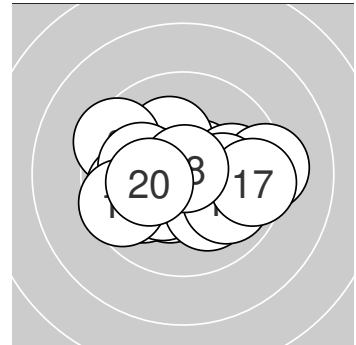

Serie 1: 100.1 (96)

10.6* ↗	10.2* ↖	9.4 ↖	9.8 ←	9.9 →
10.2* ←	9.3 →	10.4* ↘	10.1 →	10.2* ←

beste Teiler: 94.6 (1.), 144.4 (8.), 187.5 (2.)
 Trefferlage: 0.16 mm links, 0.20 mm hoch
 Streuwert: 1.89, horizontal: 2.48, vertikal: 0.98

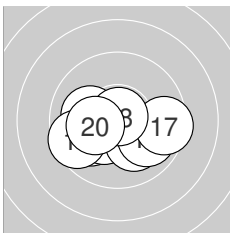

Serie 2: 101.2 (97)

10.0 ←	10.3* ↙	10.7* ←	10.1 ↘	10.1 ←
9.9 ↘	9.5 →	10.8* ↑	9.6 ←	10.2* ←

beste Teiler: 29.4 (18.), 58.5 (13.), 155.1 (12.)
 Trefferlage: 0.34 mm links, 0.71 mm tief
 Streuwert: 1.60, horizontal: 2.13, vertikal: 0.76



Ergebnis: 208.2 (200)
Serien: 105.0 103.2
Zähler: 20 0 0 0 0 0 0 0 0 0 0
Innenzehner: 16
Weiteste: 236 (19.), 221 (11.), 213 (7.)
beste Teiler: 37.4 (8.), 49.4 (2.), 50.2 (15.)
Trefferlage: 0.24 mm rechts, 0.12 mm tief
Streuwert: 1.08, horizontal: 1.34, vertikal: 0.72

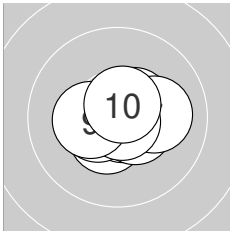
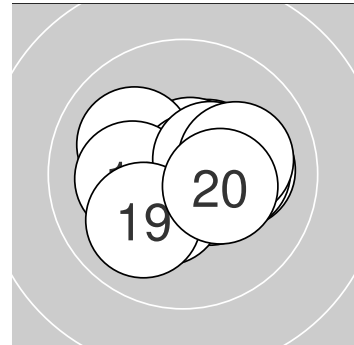

Serie 1: 105.0 (100)

10.5* ↙	10.8* ↘	10.5* ←	10.5* ↗	10.4* →
10.5* ↘	10.1 →	10.8* ↘	10.3* ←	10.6* ↗

beste Teiler: 37.4 (8.), 49.4 (2.), 79.1 (10.)
Trefferlage: 0.29 mm rechts, 0.11 mm tief
Streuwert: 0.90, horizontal: 1.15, vertikal: 0.55

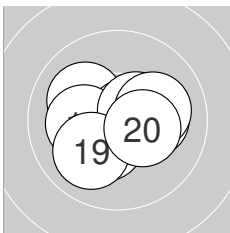

Serie 2: 103.2 (100)

10.1 ↖	10.4* ↙	10.6* →	10.2* →	10.8* ↗
10.2* ←	10.5* ↗	10.1 →	10.0 ↙	10.3* ↘

beste Teiler: 50.2 (15.), 100.4 (13.), 121.7 (17.)
Trefferlage: 0.18 mm rechts, 0.13 mm tief
Streuwert: 1.28, horizontal: 1.58, vertikal: 0.88



Ergebnis: 191.9 (182)
Serien: 97.7 94.2
Zähler: 5 12 3 0 0 0 0 0 0 0
Innenzehner: 4
Weiteste: 684 (19.), 669 (18.), 572 (11.)
beste Teiler: 63.6 (3.), 65.8 (17.), 160.0 (16.)
Trefferlage: 0.13 mm rechts, 0.32 mm hoch
Streuwert: 2.73, horizontal: 3.44, vertikal: 1.77

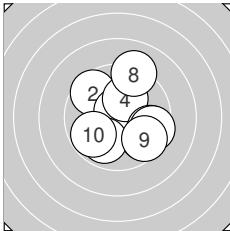
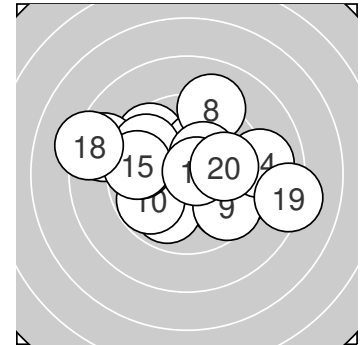

Serie 1: 97.7 (92)

9.7 ↘	9.6 ↘	10.7* ↑	10.2* ↑	9.6 ↘
9.5 →	9.9 ↙	9.1 ↑	9.6 ↘	9.8 ↙

beste Teiler: 63.6 (3.), 196.8 (4.), 262.8 (7.)
Trefferlage: 0.79 mm rechts, 0.11 mm tief
Streuwert: 2.26, horizontal: 2.24, vertikal: 2.28

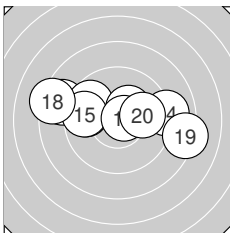

Serie 2: 94.2 (90)

8.7 ←	9.7 ←	9.7 ↘	9.0 →	9.6 ←
10.3* ↗	10.7* →	8.3 ←	8.2 →	10.0 →

beste Teiler: 65.8 (17.), 160.0 (16.), 250.0 (20.)
Trefferlage: 0.53 mm links, 0.76 mm hoch
Streuwert: 3.16, horizontal: 4.35, vertikal: 1.00



Ergebnis: **198.0** (188)
 Serien: 99.8 98.2
 Zähler: 12 6 0 2 0 0 0 0 0 0
 Innenzehner: 10
 Weitester: 891 (18.), 832 (13.), 484 (10.)
 beste Teiler: 51.8 (4.), 76.4 (17.), 84.0 (20.)
 Trefferlage: 1.73 mm links, 0.25 mm hoch
 Streuwert: 2.18, horizontal: 2.89, vertikal: 1.08

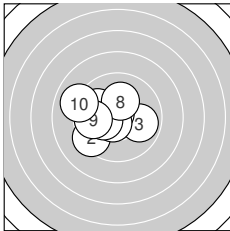
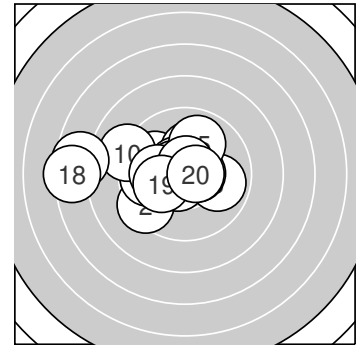

Serie 1: 99.8 (95)

10.0 ← 9.4 ↙ 9.9 →
 10.6* ↘ 10.3* ← 10.2* ↑

10.7* ↖ 9.9 ↙
 9.8 ← 9.0 ↙

beste Teiler: 51.8 (4.), 87.3 (6.), 169.5 (7.)
 Trefferlage: 1.49 mm links, 0.03 mm hoch
 Streuwert: 1.71, horizontal: 2.04, vertikal: 1.29

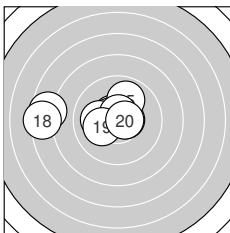

Serie 2: 98.2 (93)

10.6* ↖ 10.6* ↖ 7.6 ← 10.6* → 9.9 ↑
 10.1 ← 10.6* ↑ 7.4 ← 10.2* ← 10.6* →

10.6* → 9.9 ↑
 10.2* ← 10.6* →

beste Teiler: 76.4 (17.), 84.0 (20.), 92.1 (12.)
 Trefferlage: 1.98 mm links, 0.47 mm hoch
 Streuwert: 2.65, horizontal: 3.65, vertikal: 0.85



Ergebnis: **207.8** (196)
 Serien: 102.8 105.0
 Zähler: 16 4 0 0 0 0 0 0 0 0 0
 Innenzehner: 16
 Weitesten: 328 (17.), 324 (5.), 305 (9.)
 beste Teiler: 20.6 (15.), 27.0 (1.), 53.2 (3.)
 Trefferlage: 0.40 mm rechts, 0.40 mm tief
 Streuwert: 1.16, horizontal: 1.16, vertikal: 1.16

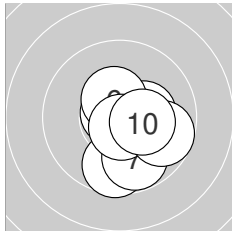
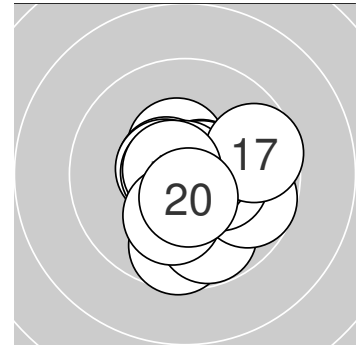

Serie 1: 102.8 (97)

10.8* →	10.3* →	10.7* ↖	10.4* ↓	9.7 ↓
10.4* ↗	9.8 ↓	10.7* ↓	9.7 →	10.3* →

beste Teiler: 27.0 (1.), 53.2 (3.), 69.2 (8.)
 Trefferlage: 0.70 mm rechts, 0.75 mm tief
 Streuwert: 1.23, horizontal: 1.07, vertikal: 1.38

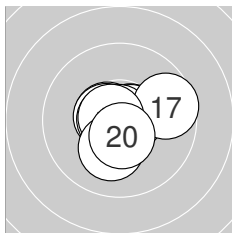

Serie 2: 105.0 (99)

10.6* →	10.6* →	10.6* ↖	10.6* ←	10.9* ↗
10.7* ←	9.6 →	10.7* ↖	10.2* ↓	10.5* ↓

beste Teiler: 20.6 (15.), 62.2 (18.), 68.3 (16.)
 Trefferlage: 0.11 mm rechts, 0.05 mm tief
 Streuwert: 1.04, horizontal: 1.23, vertikal: 0.81



Ergebnis: **204.6** (197)
 Serien: 103.3 101.3
 Zähler: 17 3 0 0 0 0 0 0 0 0 0
 Innenzehner: 11
 Weitestе: 415 (13.), 302 (17.), 252 (16.)
 beste Teiler: 46.7 (8.), 49.6 (9.), 63.0 (4.)
 Trefferlage: 0.08 mm links, 0.14 mm tief
 Streuwert: 1.48, horizontal: 1.90, vertikal: 0.87

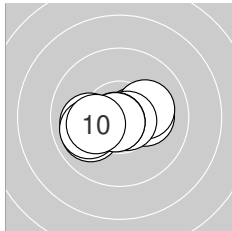
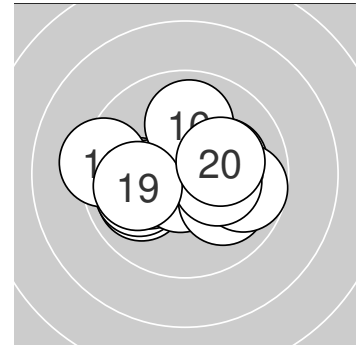

Serie 1: 103.3 (100)

10.5* →	10.2* →	10.1 →	10.7* →	10.0 ←
10.0 ←	10.0 ←	10.8* ↙	10.8* ↙	10.2* ←

beste Teiler: 46.7 (8.), 49.6 (9.), 63.0 (4.)
 Trefferlage: 0.37 mm links, 0.33 mm tief
 Streuwert: 1.25, horizontal: 1.71, vertikal: 0.49

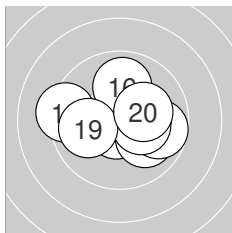

Serie 2: 101.3 (97)

10.7* ↓	10.7* ↓	9.3 ←	10.0 ↘	10.5* ↗
9.9 ↑	9.7 →	10.3* →	10.0 ←	10.2* →

beste Teiler: 67.3 (11.), 73.6 (12.), 110.2 (15.)
 Trefferlage: 0.21 mm rechts, 0.03 mm hoch
 Streuwert: 1.71, horizontal: 2.13, vertikal: 1.14



Ergebnis: **201.8** (192)
 Serien: 100.1 101.7
 Zähler: 12 8 0 0 0 0 0 0 0 0
 Innenzehner: 11
 Weitestе: 486 (14.), 479 (5.), 434 (16.)
 beste Teiler: 46.1 (18.), 46.5 (12.), 68.0 (6.)
 Trefferlage: 0.09 mm rechts, 0.17 mm hoch
 Streuwert: 1.92, horizontal: 2.50, vertikal: 1.07

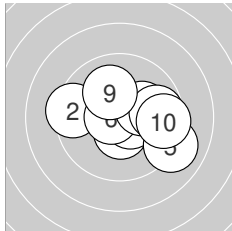
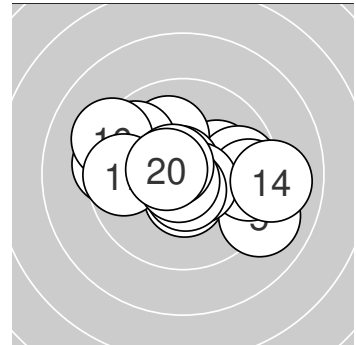

Serie 1: 100.1 (96)

10.4* ↖	9.4 ←	10.5* ↓	10.6* →	9.0 ↘
10.7* ←	10.2* ↗	9.7 →	10.1 ↖	9.5 →

beste Teiler: 68.0 (6.), 96.3 (4.), 121.3 (3.)
 Trefferlage: 0.77 mm rechts, 0.08 mm hoch
 Streuwert: 1.95, horizontal: 2.46, vertikal: 1.24

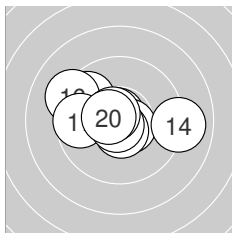

Serie 2: 101.7 (96)

9.7 ↖	10.8* ↖	10.6* ↘	9.0 →	10.6* ↓
9.2 ↖	9.7 ←	10.8* ↙	10.7* ↖	10.6* ←

beste Teiler: 46.1 (18.), 46.5 (12.), 74.4 (19.)
 Trefferlage: 0.59 mm links, 0.26 mm hoch
 Streuwert: 1.86, horizontal: 2.46, vertikal: 0.94



Ergebnis: **200.4** (193)
 Serien: 99.4 101.0
 Zähler: 14 5 1 0 0 0 0 0 0 0
 Innenzehner: 9
 Weitester: 660 (10.), 411 (9.), 332 (7.)
 beste Teiler: 64.3 (8.), 77.1 (1.), 78.2 (16.)
 Trefferlage: 0.58 mm rechts, 0.28 mm hoch
 Streuwert: 1.88, horizontal: 2.35, vertikal: 1.24

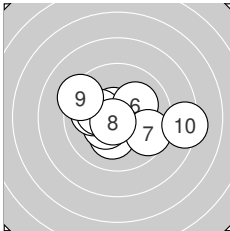
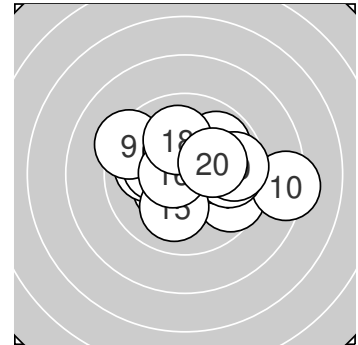

Serie 1: 99.4 (96)

10.6* ↖ 10.2* ↓ 10.4* ↘
 10.1 ↗ 9.6 ↘ 10.7* ↘

10.0 ← 10.2* ←
 9.3 ↖ 8.3 →

beste Teiler: 64.3 (8.), 77.1 (1.), 145.0 (3.)
 Trefferlage: 0.09 mm rechts, 0.06 mm tief
 Streuwert: 2.26, horizontal: 2.96, vertikal: 1.21

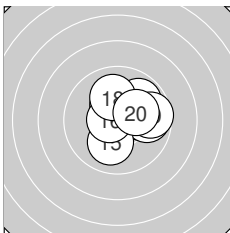

Serie 2: 101.0 (97)

10.1 → 10.3* ↖ 9.8 →
 10.6* ← 9.9 ↗ 10.0 ↑

10.3* ↗ 10.1 ↓
 9.7 → 10.2* ↗

beste Teiler: 78.2 (16.), 155.2 (12.), 175.4 (14.)
 Trefferlage: 1.07 mm rechts, 0.64 mm hoch
 Streuwert: 1.40, horizontal: 1.55, vertikal: 1.23



Ergebnis: **194.0** (185)
 Serien: 97.1 96.9
 Zähler: 10 6 3 1 0 0 0 0 0 0
 Innenzehner: 6
 Weitesten: 779 (16.), 737 (7.), 734 (20.)
 beste Teiler: 40.7 (4.), 61.2 (15.), 98.2 (9.)
 Trefferlage: 0.80 mm rechts, 0.02 mm tief
 Streuwert: 2.75, horizontal: 3.30, vertikal: 2.05

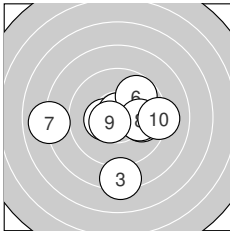
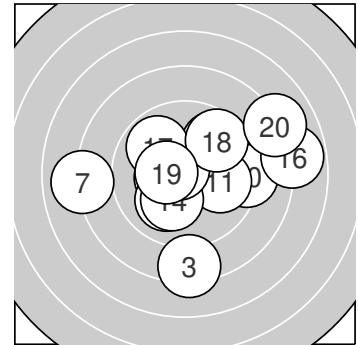

Serie 1: 97.1 (93)

10.4* ← 9.9 → 8.3 ↓ 10.8* ↑ 10.1 →
 9.8 ↗ 8.0 ← 10.0 → 10.6* ↖ 9.2 →
 beste Teiler: 40.7 (4.), 98.2 (9.), 141.2 (1.)
 Trefferlage: 0.43 mm rechts, 0.58 mm tief
 Streuwert: 2.80, horizontal: 3.26, vertikal: 2.27

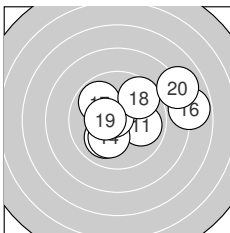

Serie 2: 96.9 (92)

9.9 → 10.0 ↙ 10.5* ← 10.1 ↙ 10.7* ↘
 7.8 → 9.9 ↘ 9.6 ↗ 10.4* ← 8.0 ↗
 beste Teiler: 61.2 (15.), 113.0 (13.), 133.5 (19.)
 Trefferlage: 1.17 mm rechts, 0.52 mm hoch
 Streuwert: 2.75, horizontal: 3.47, vertikal: 1.76



Ergebnis: 178.6 (168)
Serien: 90.7 87.9
Zähler: 6 5 4 2 2 1 0 0 0 0 0
Innenzehner: 6
Weiteste: 1330 (17.), 1111 (3.), 1030 (15.)
beste Teiler: 95.0 (14.), 113.1 (12.), 120.3 (1.)
Trefferlage: 1.22 mm links, 0.40 mm tief
Streuwert: 4.42, horizontal: 5.83, vertikal: 2.26

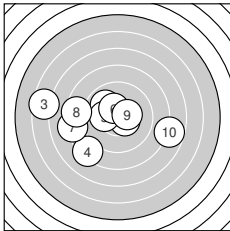
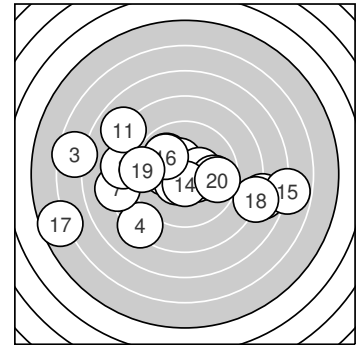

Serie 1: 90.7 (86)

10.5* ↘	9.9 ↖	6.5 ←	8.3 ↙	10.2* ←
10.4* ↖	8.2 ←	8.5 ←	10.4* →	7.8 →

beste Teiler: 120.3 (1.), 144.3 (6.), 147.2 (9.)
Trefferlage: 2.23 mm links, 0.28 mm tief
Streuwert: 3.97, horizontal: 5.18, vertikal: 2.15

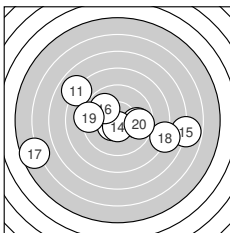

Serie 2: 87.9 (82)

7.9 ↖	10.5* ↗	9.8 →	10.6* ↓	6.8 →
9.9 ↖	5.6 ↙	8.0 →	9.2 ←	9.6 →

beste Teiler: 95.0 (14.), 113.1 (12.), 258.4 (16.)
Trefferlage: 0.22 mm links, 0.52 mm tief
Streuwert: 4.94, horizontal: 6.53, vertikal: 2.47



Ergebnis: **194.8** (185)
 Serien: 97.5 97.3
 Zähler: 7 11 2 0 0 0 0 0 0 0
 Innenzehner: 5
 Weitester: 572 (13.), 522 (18.), 479 (4.)
 beste Teiler: 43.0 (14.), 68.8 (3.), 141.2 (17.)
 Trefferlage: 0.32 mm links, 0.35 mm hoch
 Streuwert: 2.42, horizontal: 3.14, vertikal: 1.36

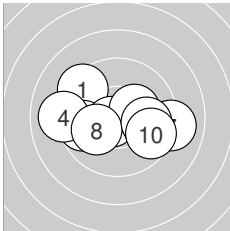
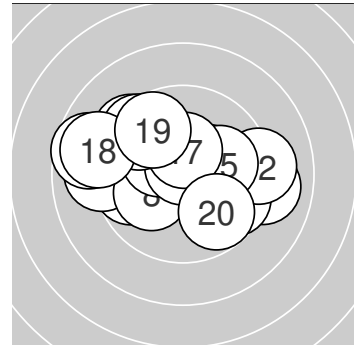

Serie 1: 97.5 (93)

9.4 ↘	9.7 ←	10.7* ↙	9.0 ←	9.8 →
10.3* →	9.0 →	10.1 ↙	9.9 →	9.6 →

beste Teiler: 68.8 (3.), 163.7 (6.), 215.5 (8.)
 Trefferlage: 0.11 mm rechts, 0.24 mm tief
 Streuwert: 2.41, horizontal: 3.21, vertikal: 1.12

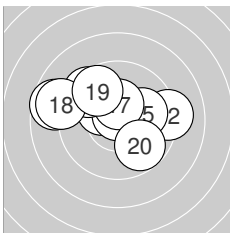

Serie 2: 97.3 (92)

10.3* ↘	9.2 →	8.7 ←	10.8* ↑	10.0 →
9.5 ↘	10.4* ↑	8.9 ↙	9.7 ↘	9.8 ↘

beste Teiler: 43.0 (14.), 141.2 (17.), 166.1 (11.)
 Trefferlage: 0.76 mm links, 0.95 mm hoch
 Streuwert: 2.44, horizontal: 3.18, vertikal: 1.35



Ergebnis: **199.1** (192)
 Serien: 99.0 100.1
 Zähler: 13 6 1 0 0 0 0 0 0 0
 Innenzehner: 9
 Weitesten: 655 (17.), 481 (3.), 444 (8.)
 beste Teiler: 93.8 (16.), 103.8 (5.), 118.8 (12.)
 Trefferlage: 0.69 mm rechts, 0.03 mm hoch
 Streuwert: 2.00, horizontal: 2.50, vertikal: 1.31

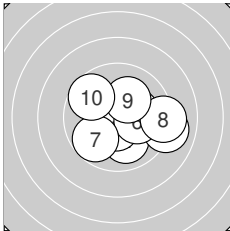
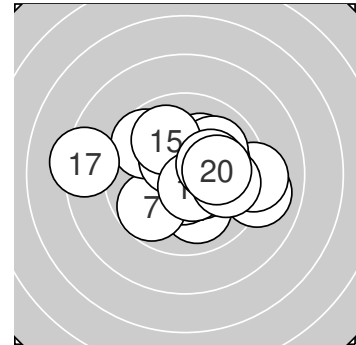

Serie 1: 99.0 (96)

10.2* ↘	10.0 ↘	9.0 →	10.2* →	10.5* ↓
10.2* →	9.8 ↗	9.2 →	10.2* ↗	9.7 ↖

beste Teiler: 103.8 (5.), 181.8 (4.), 186.9 (1.)
 Trefferlage: 1.06 mm rechts, 0.44 mm tief
 Streuwert: 1.97, horizontal: 2.37, vertikal: 1.47

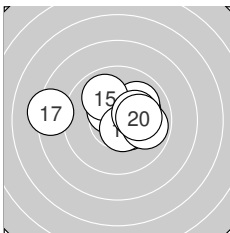

Serie 2: 100.1 (96)

10.1 →	10.5* ↖	10.0 ↗	10.5* ↘	9.9 ↖
10.6* ↘	8.3 ←	9.9 →	10.2* →	10.1 →

beste Teiler: 93.8 (16.), 118.8 (12.), 120.6 (14.)
 Trefferlage: 0.32 mm rechts, 0.51 mm hoch
 Streuwert: 2.03, horizontal: 2.71, vertikal: 0.97



Ergebnis: **196.1** (188)
 Serien: 97.4 98.7
 Zähler: 9 10 1 0 0 0 0 0 0 0
 Innenzehner: 6
 Weitester: 533 (12.), 459 (17.), 419 (10.)
 beste Teiler: 118.8 (20.), 142.1 (16.), 149.4 (14.)
 Trefferlage: 0.11 mm rechts, 0.59 mm hoch
 Streuwert: 2.18, horizontal: 2.43, vertikal: 1.90

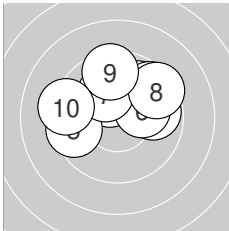
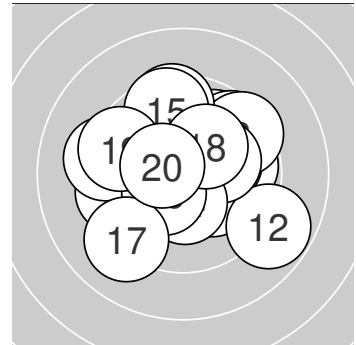

Serie 1: 97.4 (93)

9.8 ↗	10.3* ↖	9.6 ↗
10.1 →	10.1 ↖	9.4 ↗

beste Teiler: 157.6 (2.), 206.2 (6.), 211.0 (7.)
 Trefferlage: 0.23 mm rechts, 1.44 mm hoch
 Streuwert: 2.04, horizontal: 2.60, vertikal: 1.27

9.8 →	9.5 ←
9.5 ↑	9.3 ←

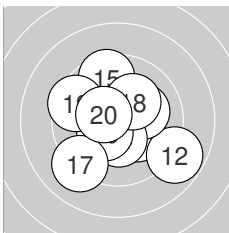

Serie 2: 98.7 (95)

10.2* ↘	8.8 ↘	10.1 →
10.4* ↗	9.1 ↗	10.2* ↗

beste Teiler: 118.8 (20.), 142.1 (16.), 149.4 (14.)
 Trefferlage: 0.00 mm, 0.24 mm tief
 Streuwert: 2.25, horizontal: 2.39, vertikal: 2.10

10.4* ↓	9.5 ↑
9.5 ↖	10.5* ↖



Ergebnis: **202.1** (195)
 Serien: 101.6 100.5
 Zähler: 15 5 0 0 0 0 0 0 0 0 0
 Innenzehner: 11
 Weitesten: 446 (7.), 341 (9.), 337 (15.)
 beste Teiler: 50.0 (2.), 91.0 (3.), 134.6 (10.)
 Trefferlage: 0.03 mm rechts, 0.22 mm hoch
 Streuwert: 1.67, horizontal: 2.06, vertikal: 1.15

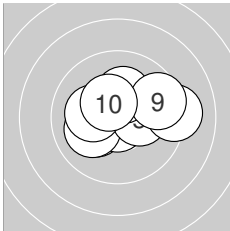
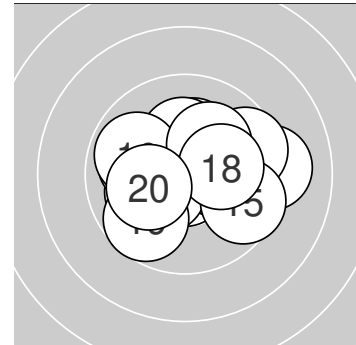

Serie 1: 101.6 (98)

10.2* ↙ 10.8* ↓ 10.6* ↑
 10.2* ↑ 9.2 → 10.2* ←
 beste Teiler: 50.0 (2.), 91.0 (3.), 134.6 (10.)
 Trefferlage: 0.34 mm rechts, 0.34 mm hoch
 Streuwert: 1.68, horizontal: 2.18, vertikal: 0.93

10.1 ↙ 10.3* →
 9.6 → 10.4* ↘

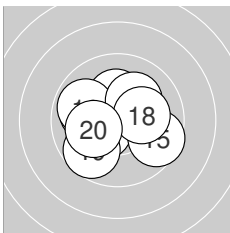

Serie 2: 100.5 (97)

10.2* ↑ 10.4* ↙ 10.3* ↗
 9.9 ↖ 10.1 ↗ 10.2* →
 beste Teiler: 140.2 (12.), 152.8 (13.), 179.4 (11.)
 Trefferlage: 0.27 mm links, 0.11 mm hoch
 Streuwert: 1.71, horizontal: 1.99, vertikal: 1.37

10.0 ↖ 9.6 ↘
 9.7 ↙ 10.1 ↙



Ergebnis: 192.6 (186)
Serien: 97.4 95.2
Zähler: 7 12 1 0 0 0 0 0 0 0
Innenzehner: 2
Weiteste: 546 (17.), 493 (9.), 452 (14.)
beste Teiler: 98.6 (1.), 104.9 (3.), 221.7 (12.)
Trefferlage: 1.26 mm links, 0.85 mm tief
Streuwert: 2.30, horizontal: 2.70, vertikal: 1.80

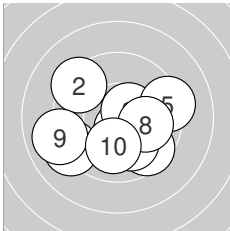
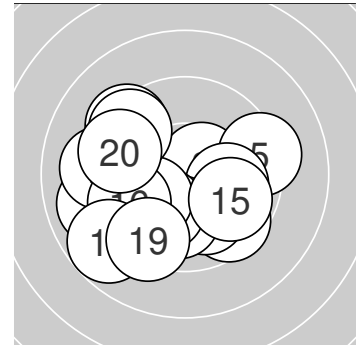

Serie 1: 97.4 (95)

10.6* ↓ 9.3 ↘ 10.5* ↗
 9.6 ↘ 10.0 ↓ 10.0 →
beste Teiler: 98.6 (1.), 104.9 (3.), 233.0 (8.)
Trefferlage: 0.09 mm links, 0.82 mm tief
Streuwert: 2.38, horizontal: 2.89, vertikal: 1.74

9.1 ← 9.3 →
 9.0 ← 10.0 ↓

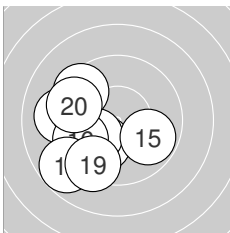

Serie 2: 95.2 (91)

9.5 ← 10.1 ✓ 10.1 ←
 9.6 ← 8.8 ✓ 9.4 ↘
beste Teiler: 221.7 (12.), 222.5 (13.), 280.2 (15.)
Trefferlage: 2.43 mm links, 0.88 mm tief
Streuwert: 1.98, horizontal: 2.01, vertikal: 1.95

9.1 ← 9.8 ↘
 9.3 ✓ 9.5 ↖



Ergebnis: 198.8 (189)
Serien: 96.9 101.9
Zähler: 10 9 1 0 0 0 0 0 0 0
Innenzehner: 7
Weiteste: 603 (3.), 435 (12.), 348 (18.)
beste Teiler: 28.4 (16.), 44.0 (20.), 97.5 (15.)
Trefferlage: 0.20 mm links, 1.03 mm hoch
Streuwert: 1.92, horizontal: 2.25, vertikal: 1.53

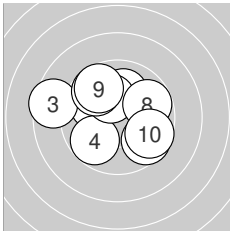
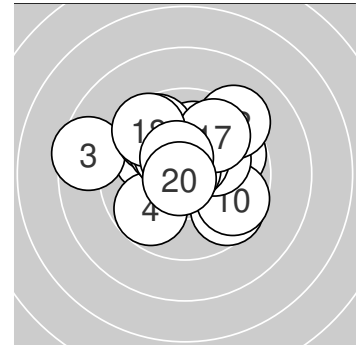

Serie 1: 96.9 (92)

10.0 ↑	10.0 ↘	8.5 ←	9.8 ↙	10.2* ↑
9.6 ↘	9.7 ↘	9.8 →	9.7 ↘	9.6 ↘

beste Teiler: 182.2 (5.), 226.0 (1.), 242.0 (2.)
Trefferlage: 0.57 mm links, 0.68 mm hoch
Streuwert: 2.38, horizontal: 2.80, vertikal: 1.86

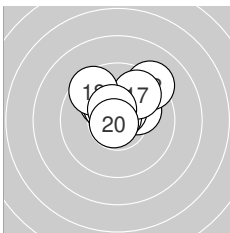

Serie 2: 101.9 (97)

10.2* ↗	9.2 ↗	10.1 ↘	10.3* ↘	10.6* ↗
10.8* ↑	9.8 ↗	9.6 ↘	10.5* ↘	10.8* ↙

beste Teiler: 28.4 (16.), 44.0 (20.), 97.5 (15.)
Trefferlage: 0.16 mm rechts, 1.38 mm hoch
Streuwert: 1.36, horizontal: 1.59, vertikal: 1.08



Ergebnis: **205.6** (195)
 Serien: 101.0 104.6
 Zähler: 15 5 0 0 0 0 0 0 0 0
 Innenzehner: 12
 Weitesten: 374 (10.), 337 (9.), 319 (5.)
 beste Teiler: 12.8 (3.), 18.3 (18.), 30.8 (20.)
 Trefferlage: 0.16 mm links, 0.77 mm tief
 Streuwert: 1.32, horizontal: 1.58, vertikal: 0.98

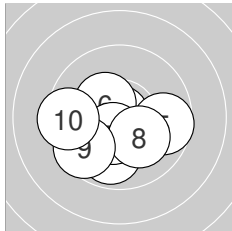
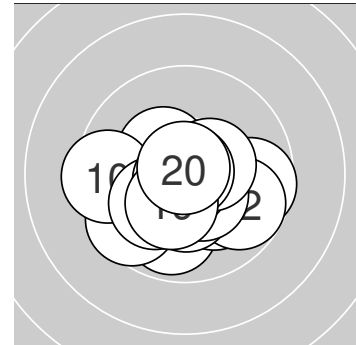

Serie 1: 101.0 (96)

10.1 ↓	10.4* ←	10.9* ↖	9.9 ↓	9.7 →
10.4* ↖	10.4* ↓	10.1 ↘	9.6 ↙	9.5 ←

beste Teiler: 12.8 (3.), 127.3 (7.), 142.0 (2.)
 Trefferlage: 0.57 mm links, 0.89 mm tief
 Streuwert: 1.59, horizontal: 1.92, vertikal: 1.17

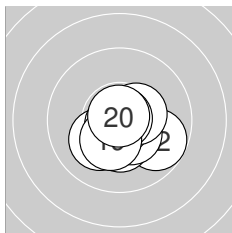

Serie 2: 104.6 (99)

10.1 ↙	9.8 ↘	10.8* ↙	10.3* ↓	10.4* ↘
10.8* ↓	10.4* →	10.9* ↗	10.3* ↙	10.8* ↑

beste Teiler: 18.3 (18.), 30.8 (20.), 33.2 (16.)
 Trefferlage: 0.23 mm rechts, 0.64 mm tief
 Streuwert: 0.96, horizontal: 1.11, vertikal: 0.78

Ergebnis: **200.3** (193)
 Serien: 99.7 100.6
 Zähler: 13 7 0 0 0 0 0 0 0 0
 Innenzehner: 9
 Weitesten: 390 (5.), 377 (1.), 376 (16.)
 beste Teiler: 77.5 (13.), 82.4 (12.), 132.8 (8.)
 Trefferlage: 0.37 mm rechts, 1.23 mm hoch
 Streuwert: 1.57, horizontal: 1.88, vertikal: 1.20

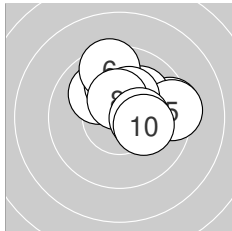
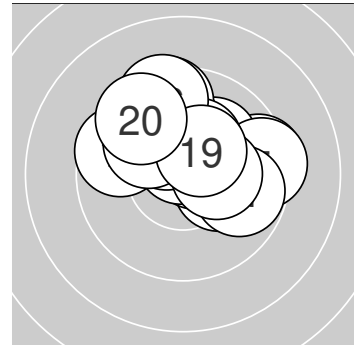

Serie 1: 99.7 (97)

9.4 →	10.1 ↗	10.0 ↘	10.0 ↑	9.4 →
9.5 ↑	10.3* ↗	10.4* ↑	10.4* →	10.2* →

beste Teiler: 132.8 (8.), 147.1 (9.), 165.5 (7.)
 Trefferlage: 1.02 mm rechts, 1.26 mm hoch
 Streuwert: 1.53, horizontal: 1.81, vertikal: 1.19

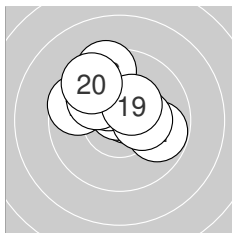

Serie 2: 100.6 (96)

9.8 →	10.6* ↗	10.6* ↑	10.3* ↘	9.6 ↖
9.4 ↑	10.3* →	10.0 ↘	10.4* ↗	9.6 ↘

beste Teiler: 77.5 (13.), 82.4 (12.), 144.6 (19.)
 Trefferlage: 0.27 mm links, 1.21 mm hoch
 Streuwert: 1.56, horizontal: 1.80, vertikal: 1.27



Ergebnis: **191.6** (180)
 Serien: 100.0 91.6
 Zähler: 9 8 0 0 3 0 0 0 0 0 0
 Innenzehner: 8
 Weitesten: 1130 (20.), 1100 (19.), 1064 (18.)
 beste Teiler: 25.9 (13.), 57.8 (3.), 87.8 (11.)
 Trefferlage: 0.99 mm links, 1.04 mm tief
 Streuwert: 3.32, horizontal: 3.26, vertikal: 3.38

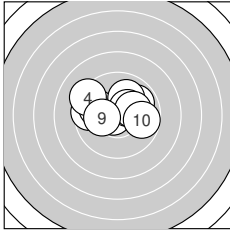
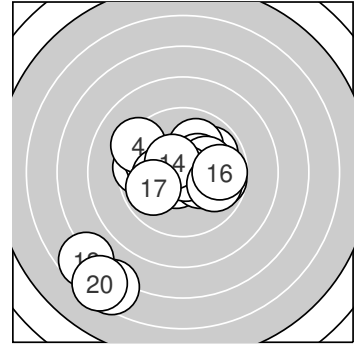

Serie 1: 100.0 (95)

9.6 ← 9.9 ↖ 10.7* ← 9.3 ↖ 9.9 ↗
 10.0 ↗ 10.4* ↗ 10.2* → 10.2* ← 9.8 →
 beste Teiler: 57.8 (3.), 149.4 (7.), 192.0 (9.)
 Trefferlage: 0.27 mm links, 0.75 mm hoch
 Streuwert: 1.86, horizontal: 2.46, vertikal: 0.96

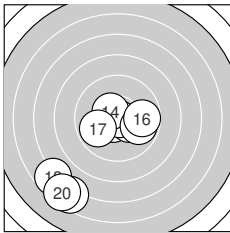

Serie 2: 91.6 (85)

10.6* ↙ 10.3* ↘ 10.9* ↘ 10.5* ↖ 9.9 ↘
 9.8 → 9.9 ↙ 6.7 ↙ 6.6 ↙ 6.4 ↙
 beste Teiler: 25.9 (13.), 87.8 (11.), 120.2 (14.)
 Trefferlage: 1.70 mm links, 2.84 mm tief
 Streuwert: 3.95, horizontal: 3.90, vertikal: 3.99



Ergebnis: **188.5** (181)
 Serien: 97.7 90.8
 Zähler: 13 3 3 0 0 0 0 0 0 0 1
 Innenzehner: 10
 Weiteste: 3605 (11.), 696 (8.), 641 (6.)
 beste Teiler: 99.9 (3.), 101.0 (18.), 105.1 (15.)
 Trefferlage: 0.21 mm links, 0.97 mm tief
 Streuwert: 6.20, horizontal: 2.82, vertikal: 8.30

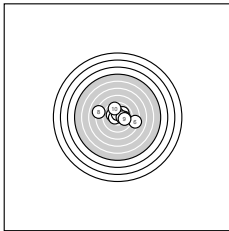
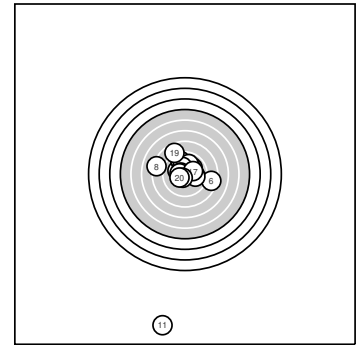

Serie 1: 97.7 (94)

10.2* ↖	10.0 ↗	10.6* ←	10.0 →	10.5* ↑
8.4 →	10.3* →	8.2 ↖	9.9 →	9.6 ↑

beste Teiler: 99.9 (3.), 110.0 (5.), 171.0 (7.)
 Trefferlage: 0.40 mm rechts, 0.59 mm hoch
 Streuwert: 2.60, horizontal: 3.41, vertikal: 1.36

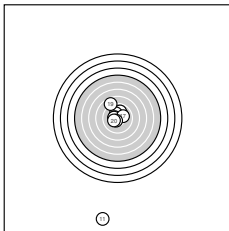

Serie 2: 90.8 (87)

0.0 ↓	10.2* ↗	9.9 ↑	10.2* ↑	10.5* ↖
10.4* ←	10.1 →	10.5* ↘	8.7 ↘	10.3* ↗

beste Teiler: 101.0 (18.), 105.1 (15.), 129.5 (16.)
 Trefferlage: 0.82 mm links, 2.55 mm tief
 Streuwert: 8.44, horizontal: 2.08, vertikal: 11.76



Ergebnis: **182.5** (175)
 Serien: 92.3 90.2
 Zähler: 5 9 3 2 1 0 0 0 0 0 0
 Innenzehner: 3
 Weitester: 1139 (7.), 913 (12.), 881 (5.)
 beste Teiler: 68.0 (3.), 68.2 (1.), 193.9 (6.)
 Trefferlage: 3.02 mm rechts, 0.24 mm hoch
 Streuwert: 3.19, horizontal: 3.89, vertikal: 2.29

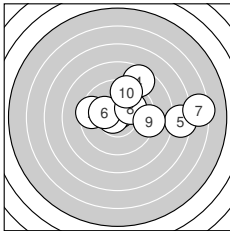
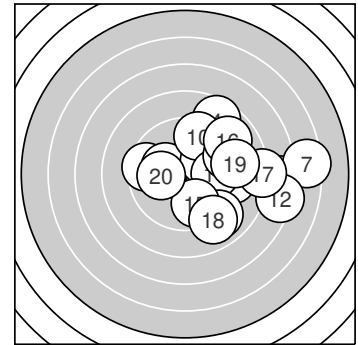

Serie 1: 92.3 (88)

10.7* ↑ 9.5 ← 10.7* ←
 10.2* ← 6.4 → 10.1 ↗

8.6 ↗ 7.4 →
 9.2 → 9.5 ↑

beste Teiler: 68.0 (3.), 68.2 (1.), 193.9 (6.)
 Trefferlage: 2.45 mm rechts, 1.18 mm hoch
 Streuwert: 3.53, horizontal: 4.66, vertikal: 1.79

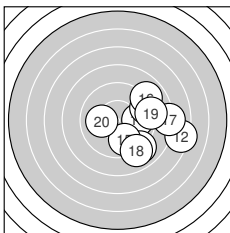

Serie 2: 90.2 (87)

9.8 → 7.3 → 9.2 →
 8.9 ↗ 8.1 → 9.0 ↘

9.0 ↘ 9.8 ↓
 9.0 → 10.1 ←

beste Teiler: 222.3 (20.), 282.0 (11.), 286.8 (15.)
 Trefferlage: 3.60 mm rechts, 0.70 mm tief
 Streuwert: 2.77, horizontal: 3.07, vertikal: 2.43



Ergebnis: **197.0** (188)
 Serien: 98.6 98.4
 Zähler: 11 6 3 0 0 0 0 0 0 0
 Innenzehner: 9
 Weitesten: 605 (20.), 556 (3.), 548 (7.)
 beste Teiler: 30.4 (8.), 85.0 (1.), 107.0 (6.)
 Trefferlage: 1.36 mm links, 1.28 mm tief
 Streuwert: 1.91, horizontal: 2.06, vertikal: 1.76

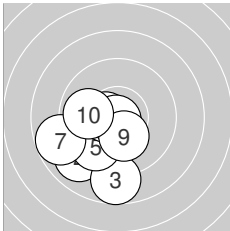
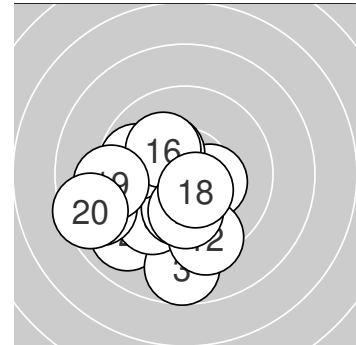

Serie 1: 98.6 (93)

10.6* ↓	9.0 ↙	8.7 ↓	10.4* ↙	9.7 ↙
10.5* ←	8.8 ↙	10.8* ↙	10.2* ↓	9.9 ←

beste Teiler: 30.4 (8.), 85.0 (1.), 107.0 (6.)
 Trefferlage: 1.49 mm links, 1.70 mm tief
 Streuwert: 1.79, horizontal: 1.78, vertikal: 1.81

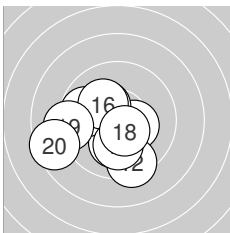

Serie 2: 98.4 (95)

10.3* →	9.4 ↓	10.1 ↓	10.3* ↘	9.8 ←
10.2* ↘	10.1 ↓	10.5* ↘	9.2 ←	8.5 ↙

beste Teiler: 113.9 (18.), 154.0 (11.), 164.5 (14.)
 Trefferlage: 1.22 mm links, 0.86 mm tief
 Streuwert: 2.07, horizontal: 2.39, vertikal: 1.70



Ergebnis: 169.1 (158)
Serien: 80.7 88.4
Zähler: 4 6 1 4 3 2 0 0 0 0 0
Innenzehner: 3
Weiteste: 1365 (11.), 1309 (13.), 1211 (5.)
beste Teiler: 41.7 (6.), 133.8 (16.), 174.2 (17.)
Trefferlage: 0.33 mm links, 1.74 mm tief
Streuwert: 5.34, horizontal: 6.69, vertikal: 3.52

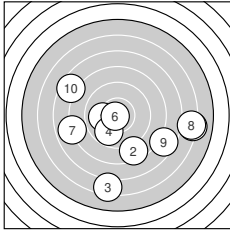
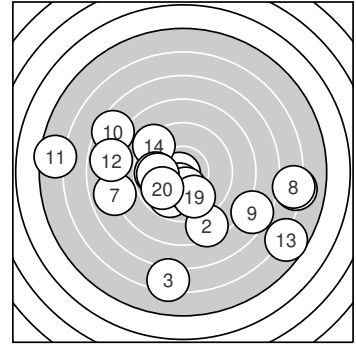

Serie 1: 80.7 (76)

10.0 ←	8.5 ↓	6.3 ↓	9.8 ↙	6.1 →
10.8* ←	7.9 ←	6.2 →	7.6 ↘	7.5 ↖

beste Teiler: 41.7 (6.), 239.5 (1.), 290.4 (4.)
Trefferlage: 1.32 mm rechts, 2.57 mm tief
Streuwert: 5.74, horizontal: 7.01, vertikal: 4.10

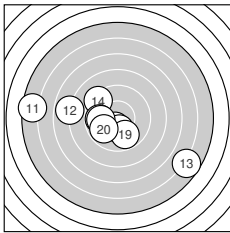

Serie 2: 88.4 (82)

5.5 ←	7.9 ←	5.7 ↘	9.3 ↖	9.8 ←
10.4* ↓	10.3* ↓	9.9 ←	9.8 ↓	9.8 ↙

beste Teiler: 133.8 (16.), 174.2 (17.), 267.9 (18.)
Trefferlage: 2.00 mm links, 0.90 mm tief
Streuwert: 4.85, horizontal: 6.26, vertikal: 2.79



Ergebnis: **200.8** (191)
 Serien: 100.7 100.1
 Zähler: 12 7 1 0 0 0 0 0 0 0
 Innenzehner: 8
 Weitestе: 595 (3.), 411 (15.), 363 (4.)
 beste Teiler: 47.8 (9.), 49.0 (6.), 63.1 (12.)
 Trefferlage: 0.15 mm rechts, 0.49 mm tief
 Streuwert: 1.89, horizontal: 2.24, vertikal: 1.45

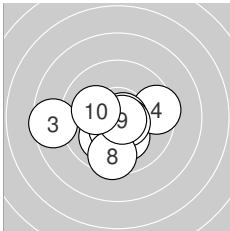
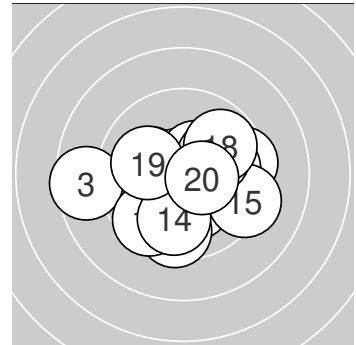

Serie 1: 100.7 (96)

10.1 ↙	10.2* ↓	8.6 ←	9.5 →	10.5* ↓
10.8* →	10.6* ↘	9.5 ↓	10.8* ↘	10.1 ←

beste Teiler: 47.8 (9.), 49.0 (6.), 89.8 (7.)
 Trefferlage: 0.41 mm links, 0.80 mm tief
 Streuwert: 1.95, horizontal: 2.45, vertikal: 1.28

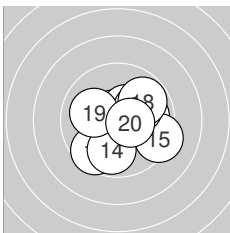

Serie 2: 100.1 (95)

9.9 →	10.7* ↖	9.6 ↙	9.8 ↓	9.3 ↘
10.4* ↗	10.1 ↗	9.8 ↗	10.0 ←	10.5* →

beste Teiler: 63.1 (12.), 118.2 (20.), 128.6 (16.)
 Trefferlage: 0.72 mm rechts, 0.19 mm tief
 Streuwert: 1.81, horizontal: 1.98, vertikal: 1.62

