

Ergebnis: **190.2** (182)
 Serien: 93.1 97.1
 Zähler: 7 9 3 1 0 0 0 0 0 0 0
 Innenzehner: 5
 Weitesten: 886 (7.), 748 (4.), 543 (9.)
 beste Teiler: 14.1 (6.), 94.4 (16.), 148.7 (11.)
 Trefferlage: 1.55 mm rechts, 0.26 mm tief
 Streuwert: 2.84, horizontal: 3.62, vertikal: 1.75

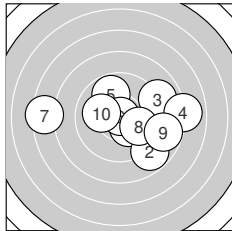
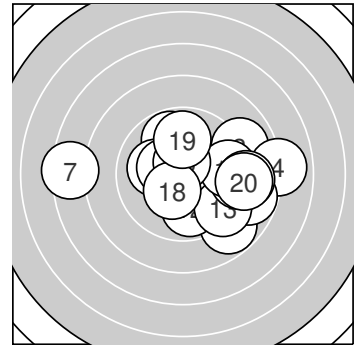

Serie 1: 93.1 (89)

10.3* ↘	8.8 ↘	9.0 →	8.0 →	9.8 ↗
10.9* ↗	7.4 ←	10.0 →	8.8 →	10.1 ←

beste Teiler: 14.1 (6.), 158.7 (1.), 219.5 (10.)
 Trefferlage: 1.20 mm rechts, 0.17 mm tief
 Streuwert: 3.53, horizontal: 4.60, vertikal: 1.94

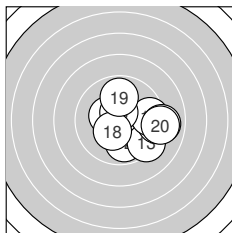

Serie 2: 97.1 (93)

10.4* ↖	9.9 ↓	9.3 ↘	9.2 →	9.5 →
10.6* ↑	9.0 →	10.3* ↙	9.9 ↑	9.0 →

beste Teiler: 94.4 (16.), 148.7 (11.), 154.4 (18.)
 Trefferlage: 1.89 mm rechts, 0.34 mm tief
 Streuwert: 2.11, horizontal: 2.50, vertikal: 1.63



LG 20 ZR

StandNr: 134

Asprian, Flora #70416100

Juniors weiblich

Wertung

StartNr: 77

04.03.2023 11:20

SG_Niederndorf

Ergebnis: **198.7** (191)
 Serien: 101.0 97.7
 Zähler: 12 7 1 0 0 0 0 0 0 0 0
 Innenzehner: 6
 Weitester: 560 (16.), 490 (14.), 406 (3.)
 beste Teiler: 60.8 (7.), 108.6 (8.), 134.8 (2.)
 Trefferlage: 0.76 mm rechts, 0.10 mm tief
 Streuwert: 1.97, horizontal: 2.49, vertikal: 1.25

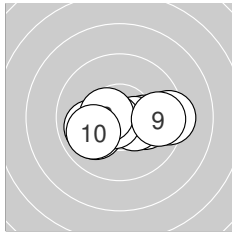
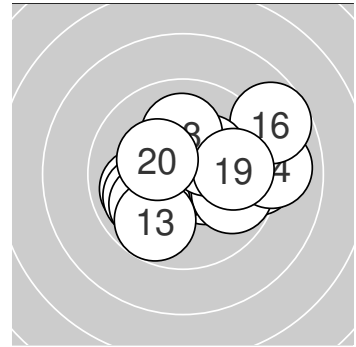

Serie 1: 101.0 (98)

10.1 →	10.4* ↘	9.3 →	10.3* ←	10.0 ←
10.0 ←	10.7* ↙	10.5* ←	9.7 →	10.0 ←

beste Teiler: 60.8 (7.), 108.6 (8.), 134.8 (2.)
 Trefferlage: 0.09 mm rechts, 0.50 mm tief
 Streuwert: 1.71, horizontal: 2.37, vertikal: 0.47

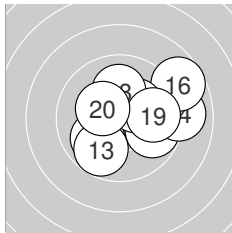

Serie 2: 97.7 (93)

9.8 ↘	10.0 ↙	9.8 ↙	9.0 →	9.9 →
8.7 ↗	10.3* ↗	10.1 ↑	9.8 →	10.3* ↖

beste Teiler: 162.1 (20.), 171.2 (17.), 221.1 (18.)
 Trefferlage: 1.42 mm rechts, 0.29 mm hoch
 Streuwert: 2.14, horizontal: 2.54, vertikal: 1.65



Ergebnis: **189.6** (180)
 Serien: 97.8 91.8
 Zähler: 8 8 1 2 1 0 0 0 0 0 0
 Innenzehner: 8
 Weitestе: 1161 (20.), 974 (6.), 777 (17.)
 beste Teiler: 50.0 (19.), 68.7 (10.), 88.1 (5.)
 Trefferlage: 0.04 mm rechts, 0.68 mm hoch
 Streuwert: 3.43, horizontal: 4.65, vertikal: 1.39

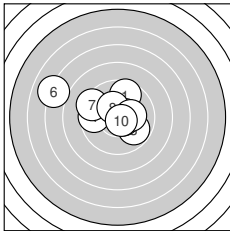
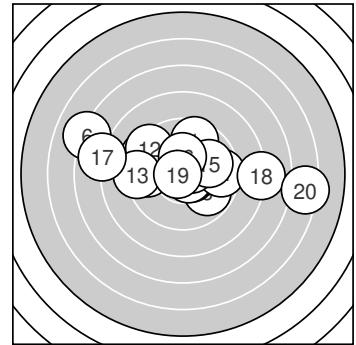

Serie 1: 97.8 (93)

9.6 ↗ 10.5* ↘ 9.8 ↘ 9.6 ← 10.6* ↘
 7.1 ↖ 9.4 ↖ 10.3* ↖ 10.2* → 10.7* ↘
 beste Teiler: 68.7 (10.), 88.1 (5.), 106.7 (2.)
 Trefferlage: 0.91 mm links, 0.82 mm hoch
 Streuwert: 2.73, horizontal: 3.49, vertikal: 1.66

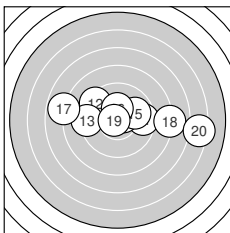

Serie 2: 91.8 (87)

9.5 → 9.4 ↘ 9.2 ← 10.6* ↗ 9.9 ↗
 10.3* ↑ 7.8 ← 8.0 → 10.8* ← 6.3 →
 beste Teiler: 50.0 (19.), 91.4 (14.), 165.0 (16.)
 Trefferlage: 1.00 mm rechts, 0.55 mm hoch
 Streuwert: 4.05, horizontal: 5.61, vertikal: 1.14



Ergebnis: **205.7** (197)
 Serien: 102.3 103.4
 Zähler: 17 3 0 0 0 0 0 0 0 0 0
 Innenzehner: 13
 Weitesten: 374 (6.), 326 (9.), 268 (17.)
 beste Teiler: 49.0 (2.), 49.0 (3.), 77.4 (1.)
 Trefferlage: 0.32 mm rechts, 0.78 mm hoch
 Streuwert: 1.21, horizontal: 1.49, vertikal: 0.86

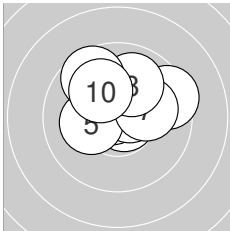
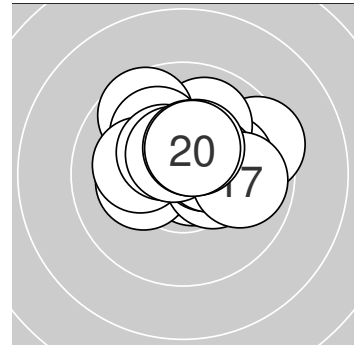

Serie 1: 102.3 (98)

10.6* ←	10.8* →	10.8* ↘	10.6* ↗	10.2* ←
9.5 →	10.1 →	10.0 ↗	9.6 ↘	10.1 ↘

beste Teiler: 49.0 (2.), 49.0 (3.), 77.4 (1.)
 Trefferlage: 0.18 mm rechts, 0.93 mm hoch
 Streuwert: 1.43, horizontal: 1.71, vertikal: 1.08

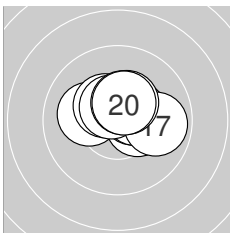

Serie 2: 103.4 (99)

10.4* →	10.1 ←	10.5* →	10.4* ↘	10.4* →
10.5* ↘	9.9 →	10.4* ↗	10.4* ↗	10.4* ↗

beste Teiler: 103.3 (16.), 118.1 (13.), 128.1 (19.)
 Trefferlage: 0.45 mm rechts, 0.64 mm hoch
 Streuwert: 1.02, horizontal: 1.31, vertikal: 0.59



Ergebnis: 197.1 (188)
Serien: 98.3 98.8
Zähler: 10 8 2 0 0 0 0 0 0 0
Innenzehner: 6
Weiteste: 578 (3.), 544 (12.), 424 (8.)
beste Teiler: 106.5 (14.), 123.5 (19.), 136.9 (15.)
Trefferlage: 0.31 mm links, 0.24 mm tief
Streuwert: 2.19, horizontal: 2.72, vertikal: 1.49

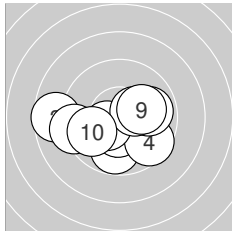
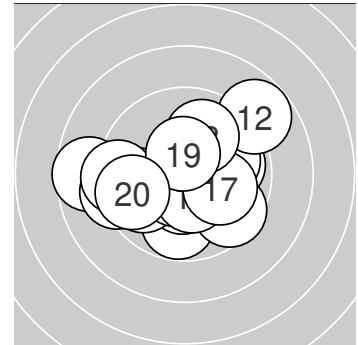

Serie 1: 98.3 (93)

9.8 ↓	10.4* ↓	8.6 ←	9.6 ↘	9.9 →
10.4* ↙	10.4* ↗	9.3 ←	10.1 →	9.8 ↙

beste Teiler: 137.5 (6.), 138.7 (2.), 147.2 (7.)
Trefferlage: 0.54 mm links, 0.77 mm tief
Streuwert: 2.22, horizontal: 2.89, vertikal: 1.22

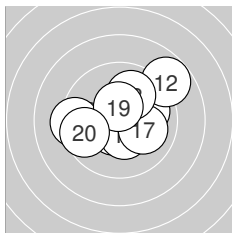

Serie 2: 98.8 (95)

10.0 →	8.8 ↗	9.7 ←	10.5* ↙	10.4* ↓
9.3 ←	10.0 ↘	10.0 ↗	10.5* ↑	9.6 ↙

beste Teiler: 106.5 (14.), 123.5 (19.), 136.9 (15.)
Trefferlage: 0.08 mm links, 0.28 mm hoch
Streuwert: 2.21, horizontal: 2.68, vertikal: 1.61



Ergebnis: 181.9 (173)
Serien: 97.3 84.6
Zähler: 4 8 6 1 1 0 0 0 0 0 0
Innenzehner: 3
Weiteste: 1051 (14.), 755 (6.), 748 (17.)
beste Teiler: 63.0 (5.), 108.8 (1.), 141.7 (7.)
Trefferlage: 1.11 mm links, 0.87 mm hoch
Streuwert: 3.68, horizontal: 4.62, vertikal: 2.40

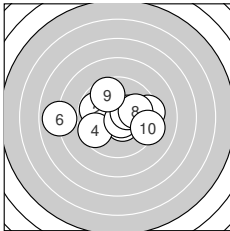
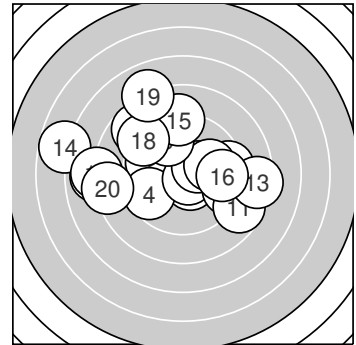

Serie 1: 97.3 (92)

10.5* ↘ 9.8 ↖ 9.4 →
 7.9 ← 10.4* ↗ 10.0 →

9.6 ↖ 10.7* ↘
 9.7 ↗ 9.3 →

beste Teiler: 63.0 (5.), 108.8 (1.), 141.7 (7.)
Trefferlage: 0.19 mm links, 0.15 mm hoch
Streuwert: 2.68, horizontal: 3.54, vertikal: 1.36

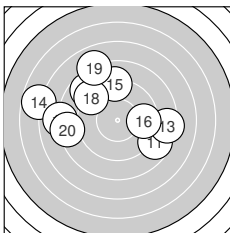

Serie 2: 84.6 (81)

8.7 ↘ 8.7 ↖ 8.4 →
 9.6 → 8.0 ← 9.1 ↖

6.7 ↖ 9.1 ↑
 8.0 ↗ 8.3 ←

beste Teiler: 340.2 (16.), 453.8 (18.), 472.4 (15.)
Trefferlage: 2.03 mm links, 1.58 mm hoch
Streuwert: 4.46, horizontal: 5.54, vertikal: 3.03



LG 20 ZR

StandNr: 139

Pollok, Hannah #70416101

Juniors weiblich

Wertung

StartNr: 82

04.03.2023 12:37

SG_Niederndorf

Ergebnis: **0.0** (0)_{DNS}
Serien:
Zähler: 0 0 0 0 0 0 0 0 0 0 0
Innenzehner: 0
Weiteste:
~~beste Teiler~~
Trefferlage: 0.00 mm , 0.00 mm
Streuwert:

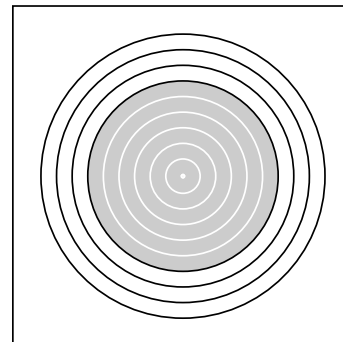

Ergebnis: **160.0** (149)
 Serien: 86.0 74.0
 Zähler: 2 5 5 3 0 3 2 0 0 0 0
 Innenzehner: 2
 Weitestе: 1648 (12.), 1541 (1.), 1458 (19.)
 beste Teiler: 64.8 (6.), 69.1 (20.), 296.6 (3.)
 Trefferlage: 7.06 mm rechts, 0.17 mm hoch
 Streuwert: 3.80, horizontal: 5.25, vertikal: 1.16

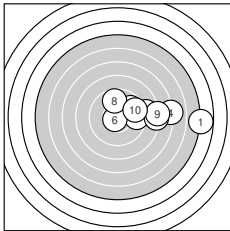
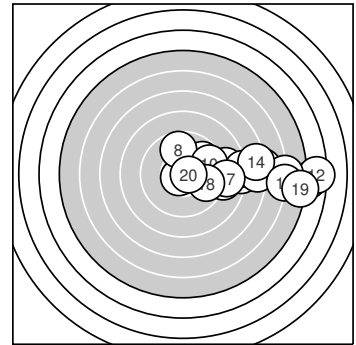

Serie 1: 86.0 (81)

4.8 → 8.8 → 9.8 ↗ 7.0 → 9.5 →
 10.7* ↖ 8.1 → 9.7 ↑ 8.0 → 9.6 ↗
 beste Teiler: 64.8 (6.), 296.6 (3.), 307.1 (8.)
 Trefferlage: 5.31 mm rechts, 0.73 mm hoch
 Streuwert: 3.54, horizontal: 4.88, vertikal: 1.14

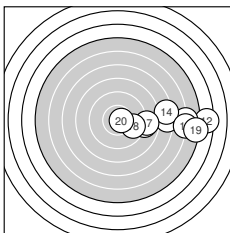

Serie 2: 74.0 (68)

7.3 → 4.4 → 5.9 → 7.3 → 8.9 →
 5.9 → 8.8 → 9.7 ↘ 5.1 → 10.7* →
 beste Teiler: 69.1 (20.), 307.0 (18.), 505.6 (15.)
 Trefferlage: 8.82 mm rechts, 0.39 mm tief
 Streuwert: 3.76, horizontal: 5.24, vertikal: 0.91



Ergebnis: 184.8 (176)
Serien: 96.2 88.6
Zähler: 6 10 1 1 1 1 0 0 0 0 0
Innenzehner: 6
Weiteste: 1383 (17.), 1165 (19.), 780 (15.)
beste Teiler: 66.9 (18.), 82.1 (2.), 84.5 (13.)
Trefferlage: 0.40 mm rechts, 0.20 mm hoch
Streuwert: 3.92, horizontal: 5.34, vertikal: 1.51

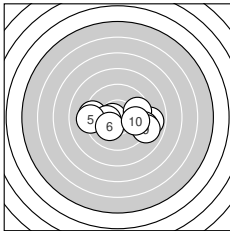
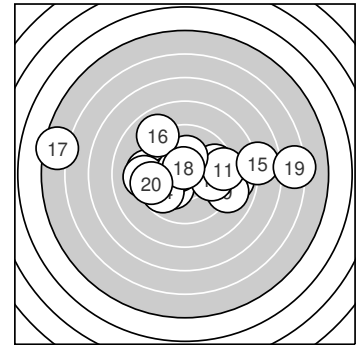

Serie 1: 96.2 (92)

9.4 ←	10.6* ←	10.3* ←	8.9 →	9.2 ←
10.2* ↙	9.6 →	9.2 →	9.0 →	9.8 →

beste Teiler: 82.1 (2.), 175.6 (3.), 194.1 (6.)
Trefferlage: 0.77 mm rechts, 0.53 mm tief
Streuwert: 2.61, horizontal: 3.59, vertikal: 0.85

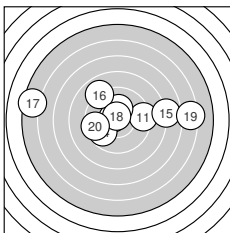

Serie 2: 88.6 (84)

9.3 →	10.2* ↑	10.6* ↖	9.8 ↙	7.8 →
9.0 ↘	5.4 ←	10.7* ↑	6.3 →	9.5 ←

beste Teiler: 66.9 (18.), 84.5 (13.), 185.7 (12.)
Trefferlage: 0.03 mm rechts, 0.93 mm hoch
Streuwert: 4.99, horizontal: 6.85, vertikal: 1.70



Ergebnis: **193.1** (183)
 Serien: 100.4 92.7
 Zähler: 7 10 2 1 0 0 0 0 0 0 0
 Innenzehner: 5
 Weitesten: 803 (13.), 673 (17.), 620 (11.)
 beste Teiler: 58.2 (5.), 107.8 (1.), 132.6 (6.)
 Trefferlage: 2.13 mm rechts, 0.21 mm hoch
 Streuwert: 2.21, horizontal: 2.75, vertikal: 1.47

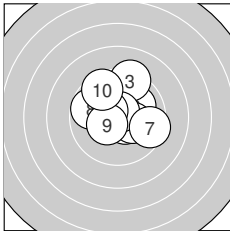
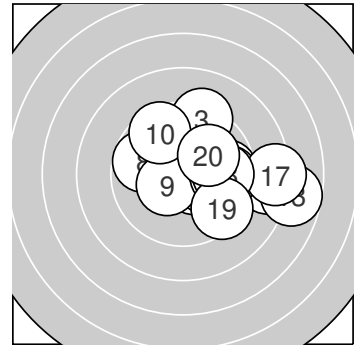

Serie 1: 100.4 (96)

10.5* ↘ 10.0 ↗ 9.3 ↑
 10.4* ↖ 9.5 ↘ 9.7 ↖

10.3* → 10.7* ↑
 10.4* ↙ 9.6 ↖

beste Teiler: 58.2 (5.), 107.8 (1.), 132.6 (6.)
 Trefferlage: 0.26 mm rechts, 0.72 mm hoch
 Streuwert: 1.83, horizontal: 1.96, vertikal: 1.69

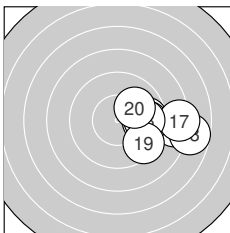

Serie 2: 92.7 (87)

8.5 → 9.9 → 7.7 → 9.7 → 9.8 →
 9.6 → 8.3 → 9.8 → 9.4 ↘ 10.0 ↗

beste Teiler: 231.0 (20.), 258.2 (12.), 276.4 (15.)
 Trefferlage: 4.01 mm rechts, 0.28 mm tief
 Streuwert: 1.66, horizontal: 2.09, vertikal: 1.08



Ergebnis: **208.7** (199)
 Serien: 104.1 104.6
 Zähler: 19 1 0 0 0 0 0 0 0 0
 Innenzehner: 17
 Weitesten: 425 (3.), 224 (16.), 220 (14.)
 beste Teiler: 11.4 (12.), 42.4 (5.), 53.5 (4.)
 Trefferlage: 0.28 mm rechts, 0.06 mm hoch
 Streuwert: 1.12, horizontal: 1.49, vertikal: 0.57

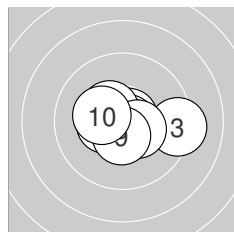
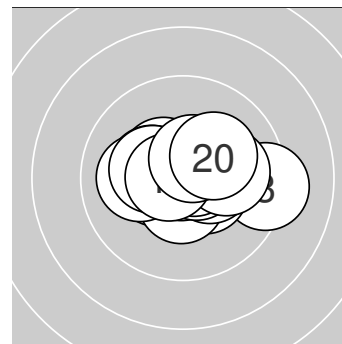

Serie 1: 104.1 (99)

10.6* ↘	10.4* ←	9.3 →	10.7* ↗	10.8* ↘
10.7* ↘	10.4* ↘	10.4* ↘	10.5* ↓	10.3* ←

beste Teiler: 42.4 (5.), 53.5 (4.), 67.8 (6.)
 Trefferlage: 0.33 mm rechts, 0.19 mm tief
 Streuwert: 1.23, horizontal: 1.64, vertikal: 0.58

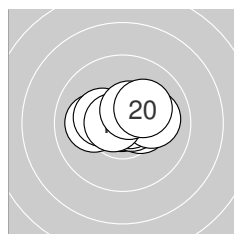

Serie 2: 104.6 (100)

10.4* →	10.9* ↘	10.7* →	10.1 ←	10.7* ↗
10.1 →	10.3* ←	10.7* ←	10.5* ↗	10.2* ↗

beste Teiler: 11.4 (12.), 63.0 (15.), 70.5 (13.)
 Trefferlage: 0.23 mm rechts, 0.33 mm hoch
 Streuwert: 1.03, horizontal: 1.40, vertikal: 0.42



Ergebnis: **180.7** (173)
 Serien: 91.3 89.4
 Zähler: 3 9 7 0 1 0 0 0 0 0 0
 Innenzehner: 1
 Weitester: 1026 (4.), 711 (1.), 701 (15.)
 beste Teiler: 134.7 (7.), 203.6 (3.), 210.8 (16.)
 Trefferlage: 0.33 mm links, 0.46 mm hoch
 Streuwert: 3.75, horizontal: 4.47, vertikal: 2.85

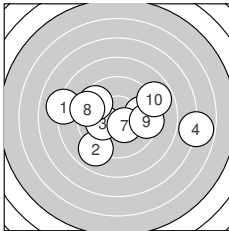
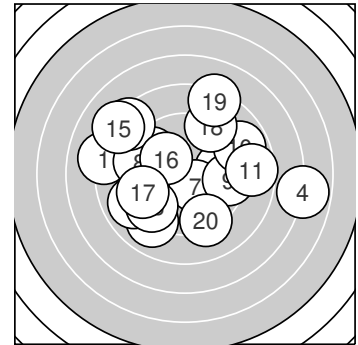

Serie 1: 91.3 (87)

8.1 ← 9.0 ↙ 10.1 ←
 9.7 → 10.4* ↘ 9.3 ←

6.8 → 9.6 ↘
 9.4 → 8.9 ↗

beste Teiler: 134.7 (7.), 203.6 (3.), 313.5 (6.)
 Trefferlage: 0.40 mm rechts, 0.06 mm tief
 Streuwert: 3.83, horizontal: 5.08, vertikal: 1.90

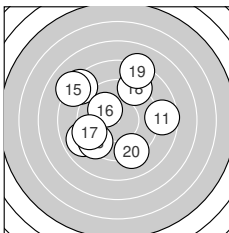

Serie 2: 89.4 (86)

8.6 → 8.9 ↙ 9.4 ↙
 10.1 ↘ 9.4 ↙ 9.1 ↗

8.4 ↘ 8.1 ↘
 8.2 ↗ 9.2 ↘

beste Teiler: 210.8 (16.), 395.6 (17.), 396.0 (13.)
 Trefferlage: 1.08 mm links, 0.98 mm hoch
 Streuwert: 3.74, horizontal: 3.88, vertikal: 3.60



LG 20 ZR

StandNr: 101

Kofler, Lena #70407288**Juniors weiblich**

Wertung

StartNr: 88

04.03.2023 12:28

SG_Ebbser_Schützen

Ergebnis: **192.1** (182)
 Serien: 98.9 93.2
 Zähler: 8 7 4 1 0 0 0 0 0 0 0
 Innenzehner: 7
 Weitestе: 809 (19.), 672 (13.), 638 (11.)
 beste Teiler: 53.0 (4.), 67.4 (1.), 102.9 (14.)
 Trefferlage: 0.50 mm rechts, 1.00 mm hoch
 Streuwert: 2.77, horizontal: 3.62, vertikal: 1.52

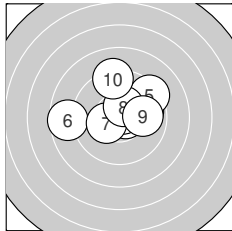
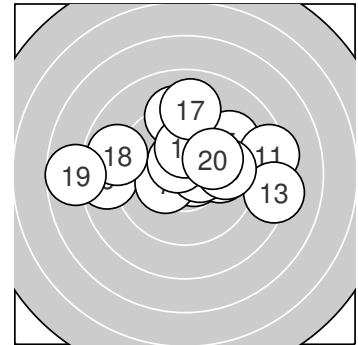
**Serie 1: 98.9 (93)**

10.7* → 9.9 ↗ 9.9 →
 8.6 ← 10.3* ↖ 10.4* ↑

10.7* ↗ 9.3 ↗
 9.9 → 9.2 ↑

beste Teiler: 53.0 (4.), 67.4 (1.), 128.7 (8.)
 Trefferlage: 0.43 mm rechts, 0.94 mm hoch
 Streuwert: 2.17, horizontal: 2.68, vertikal: 1.49

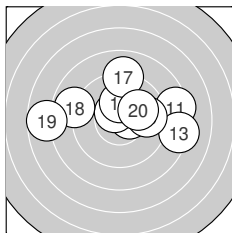
**Serie 2: 93.2 (89)**

8.4 → 10.5* → 8.3 →
 10.2* ↑ 9.0 ↑ 8.9 ←

10.5* ↘ 9.7 →
 7.7 ← 10.0 ↗

beste Teiler: 102.9 (14.), 111.1 (12.), 197.0 (16.)
 Trefferlage: 0.57 mm rechts, 1.07 mm hoch
 Streuwert: 3.40, horizontal: 4.53, vertikal: 1.62



Ergebnis: **184.7** (176)
 Serien: 90.8 93.9
 Zähler: 6 8 3 2 1 0 0 0 0 0 0
 Innenzehner: 5
 Weitester: 1019 (5.), 931 (17.), 768 (1.)
 beste Teiler: 41.4 (8.), 101.4 (7.), 108.9 (12.)
 Trefferlage: 1.97 mm links, 0.19 mm tief
 Streuwert: 3.35, horizontal: 4.34, vertikal: 1.91

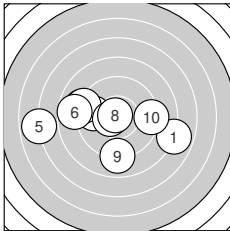
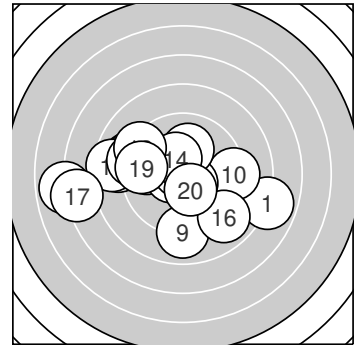

Serie 1: 90.8 (86)

7.9 →	9.0 ←	9.7 ←	9.1 ←	6.9 ←
8.7 ←	10.5* ←	10.8* ↖	9.0 ↓	9.2 →

beste Teiler: 41.4 (8.), 101.4 (7.), 314.0 (3.)
 Trefferlage: 1.74 mm links, 0.45 mm tief
 Streuwert: 3.81, horizontal: 5.01, vertikal: 1.98

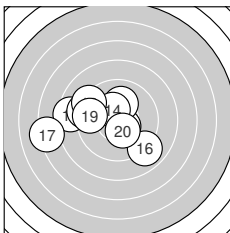

Serie 2: 93.9 (90)

8.5 ←	10.5* ↘	10.1 ↑	10.4* ↖	9.2 ←
8.9 ↘	7.2 ←	9.2 ↖	9.5 ←	10.4* ↘

beste Teiler: 108.9 (12.), 148.5 (14.), 148.9 (20.)
 Trefferlage: 2.20 mm links, 0.06 mm hoch
 Streuwert: 3.01, horizontal: 3.81, vertikal: 1.91



Ergebnis: **206.0** (197)
 Serien: 103.1 102.9
 Zähler: 18 1 1 0 0 0 0 0 0 0 0
 Innenzehner: 16
 Weitesten: 528 (10.), 453 (14.), 239 (13.)
 beste Teiler: 42.0 (3.), 47.1 (15.), 53.7 (2.)
 Trefferlage: 0.82 mm links, 0.53 mm hoch
 Streuwert: 1.29, horizontal: 1.74, vertikal: 0.56

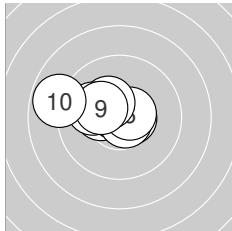
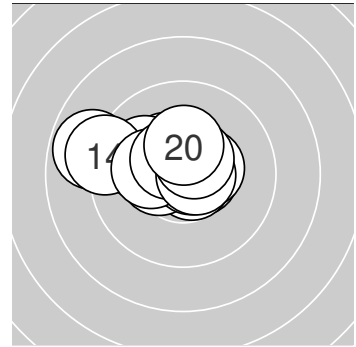

Serie 1: 103.1 (98)

10.3* ←	10.7* ↖	10.8* →	10.6* →	10.7* ↘
10.6* →	10.3* ↖	10.0 ←	10.3* ↖	8.8 ←

beste Teiler: 42.0 (3.), 53.7 (2.), 60.2 (5.)
 Trefferlage: 0.91 mm links, 0.46 mm hoch
 Streuwert: 1.36, horizontal: 1.85, vertikal: 0.56

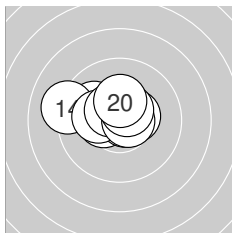

Serie 2: 102.9 (99)

10.4* ←	10.4* →	10.0 ↖	9.1 ←	10.8* →
10.2* ←	10.5* ↖	10.7* →	10.5* ↗	10.3* ↑

beste Teiler: 47.1 (15.), 73.1 (18.), 106.6 (19.)
 Trefferlage: 0.73 mm links, 0.59 mm hoch
 Streuwert: 1.29, horizontal: 1.73, vertikal: 0.58



Ergebnis: 182.9 (174)
Serien: 85.4 97.5
Zähler: 6 10 3 0 0 0 0 0 0 0 1
Innenzehner: 4
Weiteste: 3274 (7.), 613 (10.), 578 (9.)
beste Teiler: 98.8 (4.), 135.0 (20.), 145.1 (2.)
Trefferlage: 2.33 mm links, 0.12 mm tief
Streuwert: 5.66, horizontal: 7.68, vertikal: 2.24

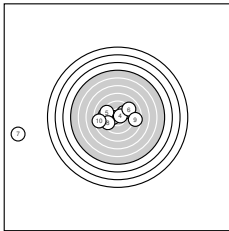
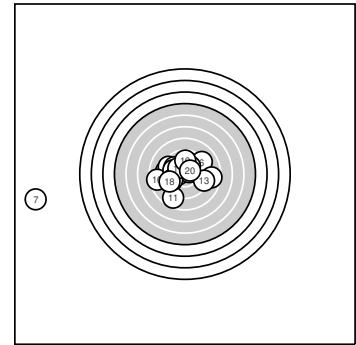

Serie 1: 85.4 (82)

10.0 ↗	10.4* ←	9.3 ←	10.6* ↗	9.4 ↘
9.1 ↗	0.0 ←	9.5 ↙	8.6 →	8.5 ←

beste Teiler: 98.8 (4.), 145.1 (2.), 247.0 (1.)
Trefferlage: 3.82 mm links, 0.23 mm tief
Streuwert: 7.71, horizontal: 10.67, vertikal: 2.28

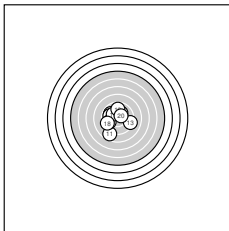

Serie 2: 97.5 (92)

8.7 ↙	9.9 ↘	9.2 →	9.9 ↘	9.8 ↙
10.1 ↗	10.2* ↘	9.5 ↙	9.8 ↑	10.4* ↗

beste Teiler: 135.0 (20.), 193.9 (17.), 201.4 (16.)
Trefferlage: 0.84 mm links, 0.02 mm tief
Streuwert: 2.35, horizontal: 2.38, vertikal: 2.33



Ergebnis: **182.0** (169)
 Serien: 87.6 94.4
 Zähler: 3 10 3 1 3 0 0 0 0 0 0
 Innenzehner: 3
 Weitestе: 1031 (7.), 1022 (10.), 1007 (2.)
 beste Teiler: 65.7 (1.), 157.9 (16.), 181.6 (4.)
 Trefferlage: 0.64 mm rechts, 1.08 mm tief
 Streuwert: 3.86, horizontal: 4.85, vertikal: 2.52

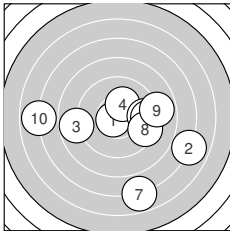
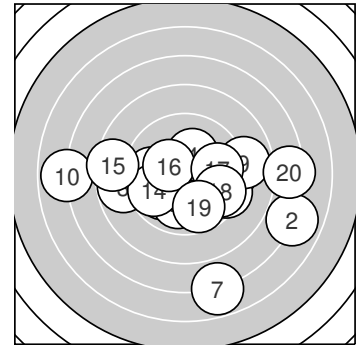

Serie 1: 87.6 (81)

10.7* ↙ 6.9 ↘ 8.8 ← 10.2* ↑ 9.6 →
 9.4 → 6.8 ↓ 9.4 ↘ 8.9 → 6.9 ←

beste Teiler: 65.7 (1.), 181.6 (4.), 347.4 (5.)
 Trefferlage: 1.26 mm rechts, 1.41 mm tief
 Streuwert: 4.59, horizontal: 5.55, vertikal: 3.36

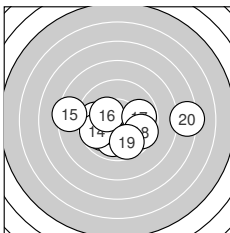

Serie 2: 94.4 (88)

9.9 ↙ 9.8 ← 9.9 ↓ 9.7 ↙ 8.4 ←
 10.3* ↘ 9.8 → 9.6 ↘ 9.7 ↓ 7.3 →

beste Teiler: 157.9 (16.), 253.4 (13.), 257.1 (11.)
 Trefferlage: 0.02 mm rechts, 0.76 mm tief
 Streuwert: 3.14, horizontal: 4.23, vertikal: 1.36



Ergebnis: **186.4** (176)
 Serien: 91.8 94.6
 Zähler: 5 8 5 2 0 0 0 0 0 0 0
 Innenzehner: 3
 Weitester: 940 (8.), 872 (2.), 698 (20.)
 beste Teiler: 43.9 (12.), 109.5 (4.), 171.1 (10.)
 Trefferlage: 0.81 mm links, 0.19 mm hoch
 Streuwert: 3.35, horizontal: 4.28, vertikal: 2.04

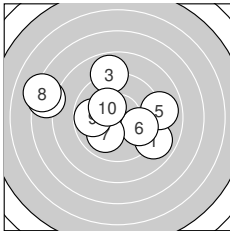
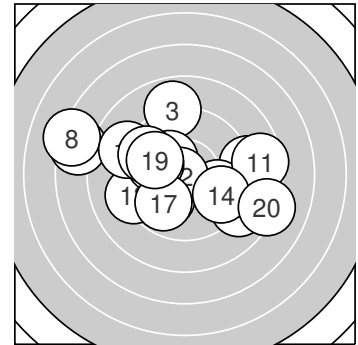

Serie 1: 91.8 (86)

8.9 ↘	7.5 ←	8.9 ↑	10.5* ↙	8.9 →
9.8 ↘	10.0 ↙	7.2 ←	9.8 ←	10.3* ↘

beste Teiler: 109.5 (4.), 171.1 (10.), 240.6 (7.)
 Trefferlage: 1.31 mm links, 0.57 mm hoch
 Streuwert: 3.71, horizontal: 4.68, vertikal: 2.37

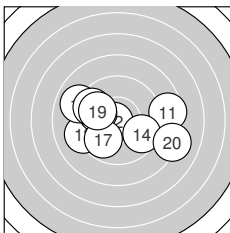

Serie 2: 94.6 (90)

8.5 →	10.8* ←	9.2 ←	9.6 ↘	9.0 ←
10.0 ←	9.8 ↙	9.6 ↘	9.9 ↘	8.2 ↘

beste Teiler: 43.9 (12.), 248.2 (16.), 262.6 (19.)
 Trefferlage: 0.32 mm links, 0.18 mm tief
 Streuwert: 3.08, horizontal: 4.02, vertikal: 1.69



Ergebnis: 198.1 (189)
Serien: 99.3 98.8
Zähler: 14 3 2 0 1 0 0 0 0 0 0
Innenzehner: 12
Weiteste: 1156 (17.), 727 (11.), 525 (3.)
beste Teiler: 55.7 (18.), 59.4 (14.), 66.9 (19.)
Trefferlage: 0.53 mm links, 1.11 mm hoch
Streuwert: 2.59, horizontal: 3.11, vertikal: 1.95

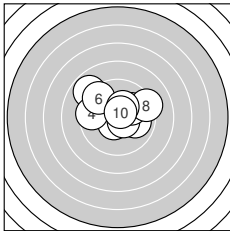
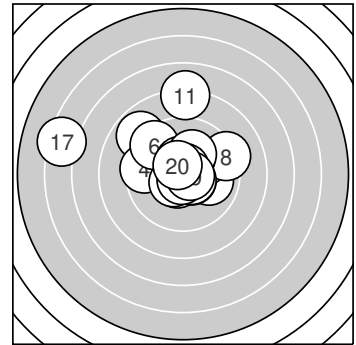

Serie 1: 99.3 (95)

10.0 →	10.6* ↙	8.9 ↘	9.5 ←	10.6* ↘
9.5 ↘	10.1 ↗	9.2 →	10.3* ↑	10.6* ↑

beste Teiler: 80.6 (10.), 100.2 (5.), 100.8 (2.)
Trefferlage: 0.03 mm links, 0.96 mm hoch
Streuwert: 2.11, horizontal: 2.61, vertikal: 1.44

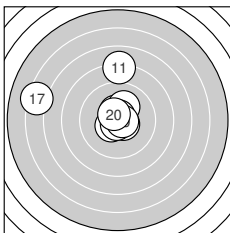

Serie 2: 98.8 (94)

8.0 ↑	10.5* ↑	10.2* ↑	10.7* ↑	10.5* ↙
10.6* ↘	6.3 ←	10.7* ↓	10.7* →	10.6* ↘

beste Teiler: 55.7 (18.), 59.4 (14.), 66.9 (19.)
Trefferlage: 1.03 mm links, 1.27 mm hoch
Streuwert: 3.07, horizontal: 3.61, vertikal: 2.42



LG 20 ZR

StandNr: 108

Fuschberger, Clara #70311108

Juniors weiblich

Wertung

StartNr: 95

04.03.2023 12:36

SG_Pillersee

Ergebnis: **196.1** (187)
 Serien: 98.6 97.5
 Zähler: 9 9 2 0 0 0 0 0 0 0
 Innenzehner: 5
 Weitester: 750 (14.), 601 (10.), 436 (5.)
 beste Teiler: 82.0 (7.), 85.9 (6.), 104.9 (1.)
 Trefferlage: 0.01 mm links, 0.96 mm tief
 Streuwert: 2.29, horizontal: 3.09, vertikal: 0.96

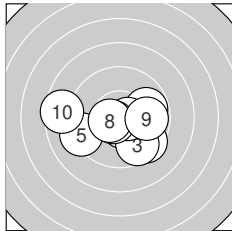
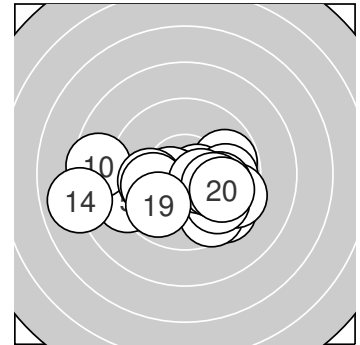

Serie 1: 98.6 (93)

10.5* ↘ 9.5 ↘ 9.6 ↘
 10.6* → 10.6* ↙ 10.5* ←

9.8 → 9.2 ←
 9.8 → 8.5 ←

beste Teiler: 82.0 (7.), 85.9 (6.), 104.9 (1.)
 Trefferlage: 0.03 mm links, 0.78 mm tief
 Streuwert: 2.28, horizontal: 2.98, vertikal: 1.23

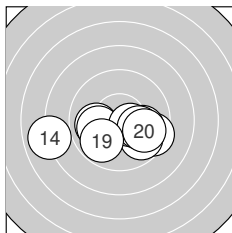

Serie 2: 97.5 (94)

10.0 ← 9.5 ↘ 10.0 →
 10.0 ← 10.5* ↘ 10.1 →

8.0 ← 9.8 ↘
 9.8 ↙ 9.8 →

beste Teiler: 121.3 (17.), 213.0 (18.), 233.0 (16.)
 Trefferlage: 0.00 mm , 1.15 mm tief
 Streuwert: 2.41, horizontal: 3.36, vertikal: 0.61



LG 20 ZR

StandNr: 109

Stricker, Franziska #70118161

Juniors weiblich

Wertung

StartNr: 96

04.03.2023 12:37

SG_Tarrenz

Ergebnis: **0.0** (0)_{DNS}
Serien:
Zähler: 0 0 0 0 0 0 0 0 0 0 0
Innenzehner: 0
Weiteste:
~~beste Teiler~~
Trefferlage: 0.00 mm , 0.00 mm
Streuwert:

