

Ergebnis: **417.5** (397)
 Serien: 105.2 103.7 104.5 104.1
 Zähler: 37 3 0 0 0 0 0 0 0 0
 Innenzehner: 30
 weiteste: 292 (32), 283 (22), 277 (35)
 beste Teiler 29.6 (3.) 30.0 (12.) 35.7 (27.)
 Trefferlage 0.28 mm links, 0.23 mm hoch
 Streuwert 1.04, horizontal: 1.23, vertikal: 0.81

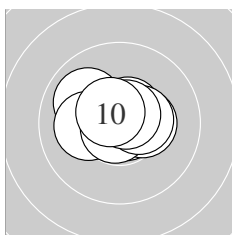

Serie 1:
 10.0 ↘ 10.8 * 10.8 * 10.6 * 10.4 *
 10.1 ← 10.8 * 10.4 * 10.7 * 10.6 *
 beste Teiler 29.6 (3.) 43.3 (2.) 46.0 (7.)
 Trefferlage 0.11 mm links, 0.28 mm hoch
 Streuwert 0.94, horizontal: 1.21, vertikal: 0.54

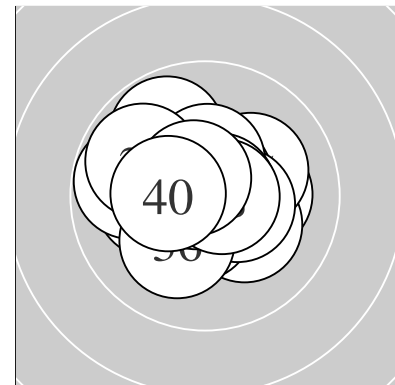
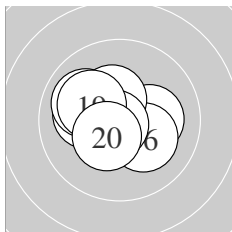

Serie 2:
 10.1 ← 10.8 * 10.7 * 10.0 ↘ 10.2 *
 10.2 * 10.4 * 10.8 * 10.1 ↘ 10.4 *
 beste Teiler 30.0 (12.) 45.6 (18.) 75.0 (13.)
 Trefferlage 0.49 mm links, 0.06 mm hoch
 Streuwert 1.17, horizontal: 1.40, vertikal: 0.87

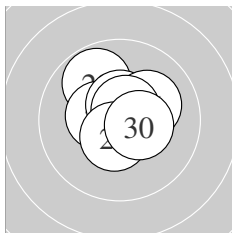

Serie 3:
 10.7 * 9.8 ↘ 10.4 * 10.6 * 10.1 ↗
 10.6 * 10.8 * 10.6 * 10.5 * 10.4 *
 beste Teiler 35.7 (27.) 71.7 (21.) 76.6 (28.)
 Trefferlage 0.15 mm rechts, 0.31 mm hoch
 Streuwert 1.02, horizontal: 1.04, vertikal: 1.00

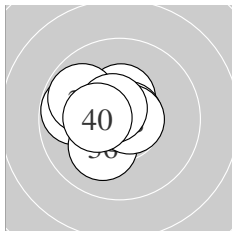

Serie 4:
 10.8 * 9.8 ← 10.4 * 10.7 * 9.8 ↘
 10.1 ↗ 10.8 * 10.7 * 10.6 * 10.4 *
 beste Teiler 38.9 (37.) 44.7 (31.) 56.6 (34.)
 Trefferlage 0.69 mm links, 0.27 mm hoch
 Streuwert 1.07, horizontal: 1.24, vertikal: 0.87

Unterschrift des Schützen

Meyton Elektronik

Ergebnis: **418.1** (399)
 Serien: 103.1 105.4 104.2 105.4
 Zähler: 39 1 0 0 0 0 0 0 0 0
 Innenzehner: 35
 weiteste: 293 (5), 232 (10), 228 (27)
 beste Teiler 29.0 (25.) 29.7 (24.) 33.0 (34.)
 Trefferlage 0.06 mm rechts, 0.12 mm tief
 Streuwert 1.01, horizontal: 1.08, vertikal: 0.92

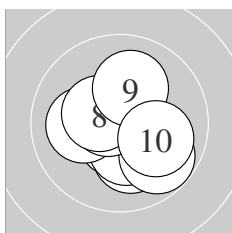
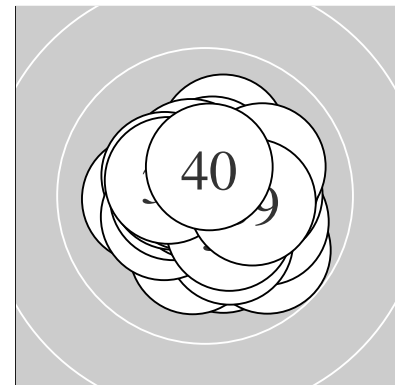

Serie 1:
 10.8 * 10.6 * 10.2 * 10.4 * 9.8 ↘
 10.1 ← 10.7 * 10.4 * 10.1 ↑ 10.0 ↘
 beste Teiler 46.5 (1.) 73.5 (7.) 94.1 (2.)
 Trefferlage 0.16 mm rechts, 0.38 mm tief
 Streuwert 1.31, horizontal: 1.36, vertikal: 1.27

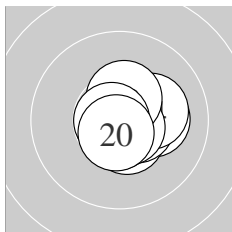

Serie 2:
 10.2 * 10.5 * 10.5 * 10.2 * 10.8 *
 10.7 * 10.7 * 10.4 * 10.8 * 10.6 *
 beste Teiler 40.4 (15.) 47.0 (19.) 61.5 (17.)
 Trefferlage 0.53 mm rechts, 0.15 mm tief
 Streuwert 0.74, horizontal: 0.81, vertikal: 0.67

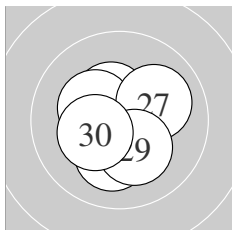

Serie 3:
 10.6 * 10.6 * 10.4 * 10.8 * 10.8 *
 10.3 * 10.0 ↗ 10.2 * 10.2 * 10.3 *
 beste Teiler 29.0 (25.) 29.7 (24.) 87.2 (21.)
 Trefferlage 0.22 mm links, 0.07 mm tief
 Streuwert 1.07, horizontal: 1.06, vertikal: 1.09

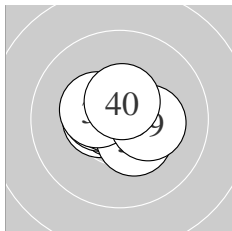

Serie 4:
 10.7 * 10.5 * 10.6 * 10.8 * 10.5 *
 10.7 * 10.4 * 10.4 * 10.3 * 10.5 *
 beste Teiler 33.0 (34.) 69.1 (31.) 73.3 (36.)
 Trefferlage 0.20 mm links, 0.11 mm hoch
 Streuwert 0.82, horizontal: 1.01, vertikal: 0.56

Unterschrift des Schützen

Ergebnis: **409.3** (389)
 Serien: 102.6 101.6 103.3 101.8
 Zähler: 30 9 1 0 0 0 0 0 0
 Innenzehner: 24
 weiteste: 553 (20), 328 (2), 327 (14)
 beste Teiler 21.9 (13.) 44.0 (16.) 47.0 (6.)
 Trefferlage 0.28 mm rechts, 0.15 mm hoch
 Streuwert 1.47, horizontal: 1.65, vertikal: 1.26

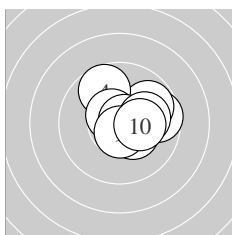
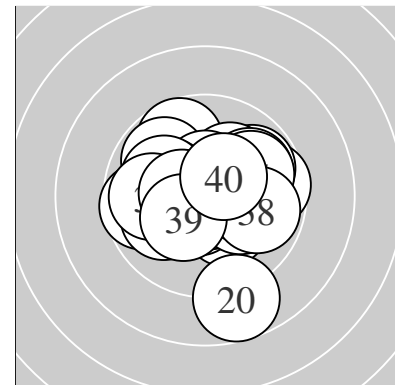

Serie 1:
 10.7 * 9.6 → 9.8 ↗ 9.7 ↖ 10.6 *
 10.8 * 10.1 → 10.4 * 10.6 * 10.3 *
 beste Teiler 47.0 (6.) 59.4 (1.) 76.1 (9.)
 Trefferlage 0.93 mm rechts, 0.50 mm hoch
 Streuwert 1.27, horizontal: 1.45, vertikal: 1.07

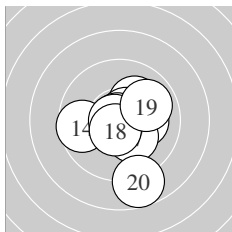

Serie 2:
 10.1 ↗ 10.6 * 10.9 * 9.6 ← 10.2 *
 10.8 * 10.2 * 10.6 * 9.9 ↗ 8.7 ↓
 beste Teiler 21.9 (13.) 44.0 (16.) 79.9 (12.)
 Trefferlage 0.46 mm rechts, 0.46 mm tief
 Streuwert 1.78, horizontal: 1.62, vertikal: 1.92

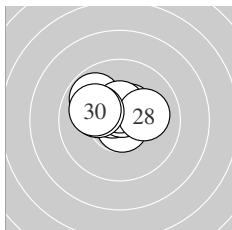

Serie 3:
 10.4 * 9.8 ↖ 10.7 * 10.6 * 10.5 *
 10.6 * 10.5 * 10.1 → 10.1 ↖ 10.0 ↖
 beste Teiler 56.4 (23.) 79.4 (26.) 91.5 (24.)
 Trefferlage 0.44 mm links, 0.77 mm hoch
 Streuwert 1.06, horizontal: 1.38, vertikal: 0.58

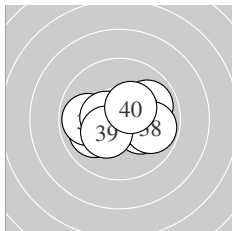

Serie 4:
 10.2 * 10.6 * 10.0 ↖ 9.9 ← 10.5 *
 10.2 * 9.9 → 9.8 → 10.3 * 10.4 *
 beste Teiler 84.0 (32.) 119.9 (35.) 138.6 (40.)
 Trefferlage 0.18 mm rechts, 0.20 mm tief
 Streuwert 1.51, horizontal: 1.99, vertikal: 0.79

Unterschrift des Schützen

Meyton Elektronik

Ergebnis: **409.4** (390)
 Serien: 102.6 101.2 103.2 102.4
 Zähler: 30 10 0 0 0 0 0 0 0 0
 Innenzehner: 26
 weiteste: 406 (15), 403 (33), 324 (30)
 beste Teiler 8.5 (28.) 50.2 (21.) 74.0 (3.)
 Trefferlage 0.57 mm rechts, 0.08 mm tief
 Streuwert 1.39, horizontal: 1.42, vertikal: 1.35

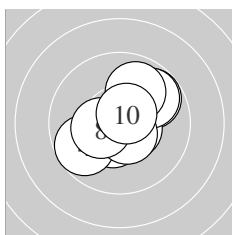
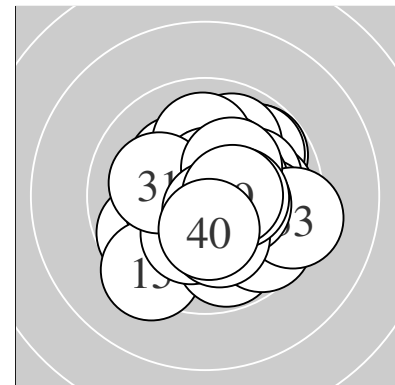

Serie 1:
 10.5 * 9.8 ↗ 10.7 * 9.7 ↙ 10.6 *
 9.8 ↗ 10.6 * 10.4 * 9.9 ↑ 10.6 *
 beste Teiler 74.0 (3.) 87.4 (10.) 96.2 (7.)
 Trefferlage 0.38 mm rechts, 0.28 mm hoch
 Streuwert 1.44, horizontal: 1.52, vertikal: 1.36

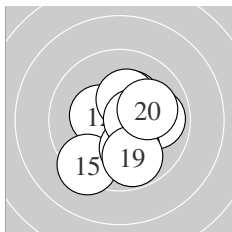

Serie 2:
 10.6 * 10.3 * 9.9 → 10.3 * 9.3 ↙
 10.3 * 10.1 ↓ 10.5 * 9.8 ↓ 10.1 →
 beste Teiler 89.8 (11.) 105.2 (18.) 151.3 (12.)
 Trefferlage 0.40 mm rechts, 0.34 mm tief
 Streuwert 1.63, horizontal: 1.55, vertikal: 1.71

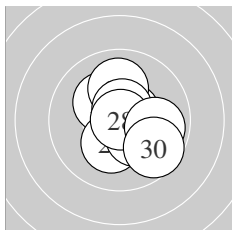

Serie 3:
 10.8 * 10.2 * 10.2 * 10.6 * 10.0 ↑
 10.3 * 10.6 * 10.9 * 9.9 → 9.7 ↘
 beste Teiler 8.5 (28.) 50.2 (21.) 83.1 (27.)
 Trefferlage 0.52 mm rechts, 0.00 mm
 Streuwert 1.32, horizontal: 1.26, vertikal: 1.38

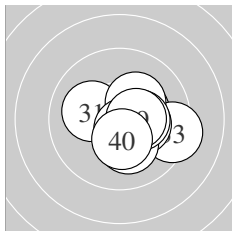

Serie 4:
 10.1 ↖ 10.3 * 9.3 → 10.3 * 10.6 *
 10.3 * 10.2 * 10.4 * 10.5 * 10.4 *
 beste Teiler 77.8 (35.) 122.0 (39.) 149.2 (38.)
 Trefferlage 0.99 mm rechts, 0.30 mm tief
 Streuwert 1.25, horizontal: 1.48, vertikal: 0.97

Unterschrift des Schützen

Meyton Elektronik

Ergebnis: **416.4** (395)
 Serien: 105.1 105.5 102.2 103.6
 Zähler: 35 5 0 0 0 0 0 0 0 0
 Innenzehner: 32
 weiteste: 381 (22), 291 (28), 289 (36)
 beste Teiler 19.4 (39.) 30.4 (16.) 41.2 (5.)
 Trefferlage 0.35 mm links, 0.06 mm hoch
 Streuwert 1.11, horizontal: 1.29, vertikal: 0.91

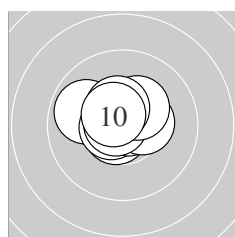
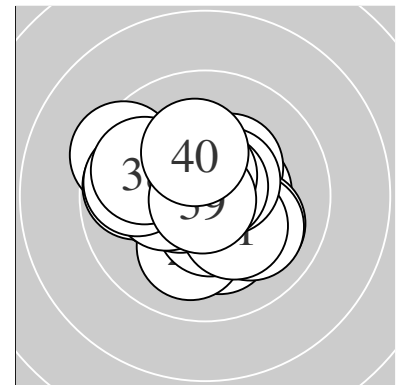

Serie 1:
 9.9 ↖ 10.7 * 10.5 * 10.6 * 10.8 *
 10.4 * 10.8 * 10.3 * 10.5 * 10.6 *
 beste Teiler 41.2 (5.) 49.0 (7.) 67.9 (2.)
 Trefferlage 0.15 mm links, 0.43 mm hoch
 Streuwert 0.91, horizontal: 1.14, vertikal: 0.58

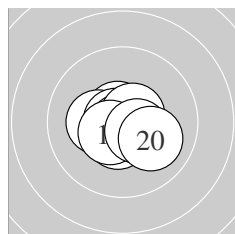

Serie 2:
 10.5 * 10.7 * 10.8 * 10.3 * 10.8 *
 10.8 * 10.6 * 10.5 * 10.5 * 10.0 ↘
 beste Teiler 30.4 (16.) 50.0 (13.) 50.2 (15.)
 Trefferlage 0.02 mm rechts, 0.26 mm tief
 Streuwert 0.85, horizontal: 1.04, vertikal: 0.60

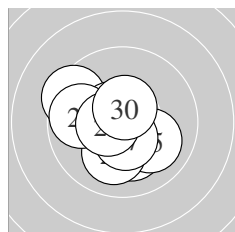

Serie 3:
 10.6 * 9.4 ↖ 10.6 * 10.2 * 10.0 ↘
 10.1 ↓ 10.5 * 9.8 ← 10.5 * 10.5 *
 beste Teiler 94.1 (21.) 95.6 (23.) 102.1 (30.)
 Trefferlage 0.65 mm links, 0.34 mm tief
 Streuwert 1.43, horizontal: 1.57, vertikal: 1.27

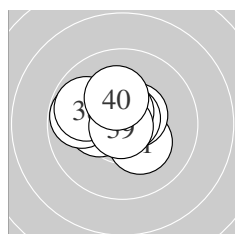

Serie 4:
 10.3 * 10.5 * 10.7 * 10.4 * 10.3 *
 9.8 ← 10.6 * 9.9 ↖ 10.9 * 10.2 *
 beste Teiler 19.4 (39.) 55.8 (33.) 86.2 (37.)
 Trefferlage 0.64 mm links, 0.42 mm hoch
 Streuwert 1.14, horizontal: 1.39, vertikal: 0.81

Unterschrift des Schützen

Ergebnis: **412.9** (394)
 Serien: 104.0 102.8 102.5 103.6
 Zähler: 34 6 0 0 0 0 0 0 0 0
 Innenzehner: 28
 weiteste: 439 (27), 327 (32), 311 (5)
 beste Teiler 11.0 (1.) 29.1 (31.) 52.4 (6.)
 Trefferlage 0.41 mm links, 0.35 mm hoch
 Streuwert 1.25, horizontal: 1.44, vertikal: 1.03

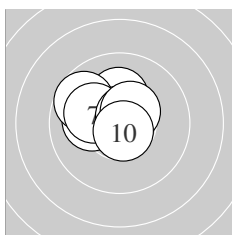
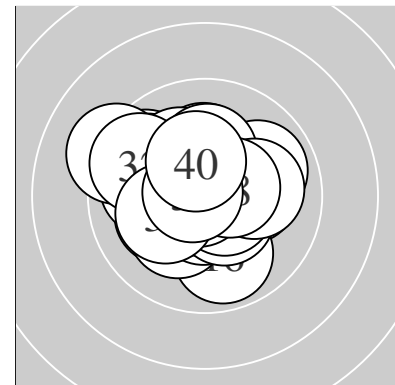

Serie 1:
 10.9 * 10.4 * 10.2 * 10.1 ← 9.7 ↖
 10.7 * 10.1 ↖ 10.7 * 10.5 * 10.7 *
 beste Teiler 11.0 (1.) 52.4 (6.) 63.9 (10.)
 Trefferlage 0.57 mm links, 0.72 mm hoch
 Streuwert 1.01, horizontal: 1.20, vertikal: 0.76

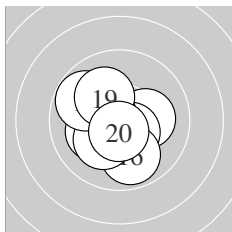

Serie 2:
 10.2 * 10.7 * 10.2 * 10.5 * 10.6 *
 9.9 ↓ 10.2 * 9.8 ↖ 10.1 ↖ 10.6 *
 beste Teiler 65.4 (12.) 84.2 (20.) 92.7 (15.)
 Trefferlage 0.45 mm links, 0.36 mm tief
 Streuwert 1.32, horizontal: 1.35, vertikal: 1.29

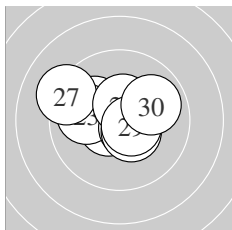

Serie 3:
 10.6 * 10.1 ↖ 10.0 ← 10.5 * 10.6 *
 10.5 * 9.2 ↖ 10.5 * 10.6 * 9.9 →
 beste Teiler 89.3 (25.) 93.0 (21.) 97.9 (29.)
 Trefferlage 0.33 mm links, 0.41 mm hoch
 Streuwert 1.51, horizontal: 1.92, vertikal: 0.94

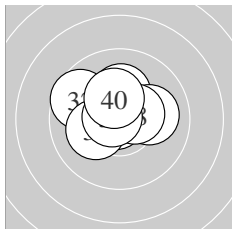

Serie 4:
 10.8 * 9.6 ↖ 10.5 * 10.7 * 10.2 *
 10.2 * 10.1 → 10.5 * 10.7 * 10.3 *
 beste Teiler 29.1 (31.) 56.3 (34.) 58.5 (39.)
 Trefferlage 0.29 mm links, 0.64 mm hoch
 Streuwert 1.15, horizontal: 1.40, vertikal: 0.82

Unterschrift des Schützen

Ergebnis: **414.3** (397)
 Serien: 103.9 103.1 104.5 102.8
 Zähler: 37 3 0 0 0 0 0 0 0 0
 Innenzehner: 31
 weiteste: 363 (16), 319 (40), 285 (8)
 beste Teiler 27.7 (10.) 39.4 (27.) 54.4 (5.)
 Trefferlage 0.18 mm rechts, 0.03 mm tief
 Streuwert 1.18, horizontal: 1.30, vertikal: 1.05

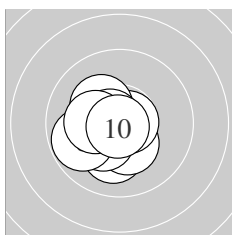
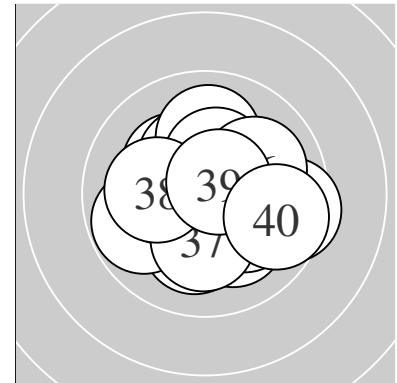

Serie 1:
 10.1 ↓ 10.3 * 10.3 * 10.7 * 10.7 *
 10.2 * 10.7 * 9.8 ← 10.3 * 10.8 *
 beste Teiler 27.7 (10.) 54.4 (5.) 58.1 (4.)
 Trefferlage 0.75 mm links, 0.44 mm tief
 Streuwert 0.98, horizontal: 0.99, vertikal: 0.97

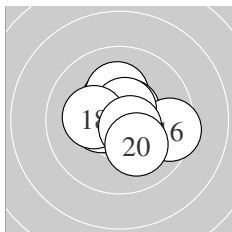

Serie 2:
 10.5 * 10.4 * 10.2 * 10.4 * 10.6 *
 9.5 → 10.6 * 10.2 * 10.6 * 10.1 ↘
 beste Teiler 87.2 (17.) 90.6 (19.) 92.6 (15.)
 Trefferlage 0.16 mm rechts, 0.20 mm hoch
 Streuwert 1.32, horizontal: 1.55, vertikal: 1.05

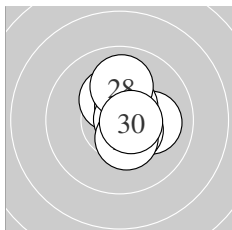

Serie 3:
 10.6 * 10.7 * 10.3 * 10.1 → 10.5 *
 10.5 * 10.8 * 10.0 ↑ 10.4 * 10.6 *
 beste Teiler 39.4 (27.) 59.7 (22.) 80.4 (21.)
 Trefferlage 0.57 mm rechts, 0.33 mm hoch
 Streuwert 0.91, horizontal: 0.70, vertikal: 1.07

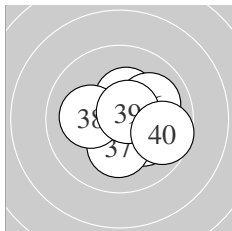

Serie 4:
 10.6 * 10.3 * 10.4 * 10.7 * 10.2 *
 10.0 ↗ 10.2 * 10.1 ← 10.6 * 9.7 →
 beste Teiler 54.8 (34.) 77.9 (39.) 93.9 (31.)
 Trefferlage 0.76 mm rechts, 0.22 mm tief
 Streuwert 1.23, horizontal: 1.39, vertikal: 1.04

Unterschrift des Schützen

Meyton Elektronik

Ergebnis: **414.6** (394)
 Serien: 104.9 102.5 103.3 103.9
 Zähler: 34 6 0 0 0 0 0 0 0 0
 Innenzehner: 31
 weiteste: 349 (40), 347 (17), 274 (23)
 beste Teiler 44.5 (6.) 72.8 (22.) 74.7 (34.)
 Trefferlage 0.21 mm links, 0.03 mm hoch
 Streuwert 1.18, horizontal: 1.36, vertikal: 0.98

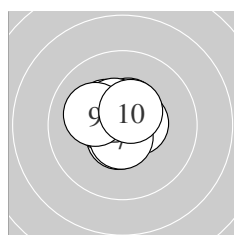
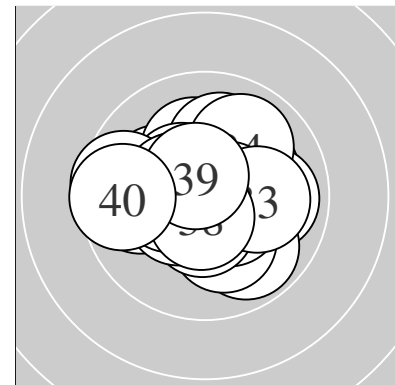

Serie 1:
 10.3 * 10.6 * 10.5 * 10.6 * 10.4 *
 10.8 * 10.6 * 10.5 * 10.1 ↖ 10.5 *
 beste Teiler 44.5 (6.) 85.5 (7.) 91.7 (2.)
 Trefferlage 0.38 mm links, 0.37 mm hoch
 Streuwert 0.83, horizontal: 0.90, vertikal: 0.75

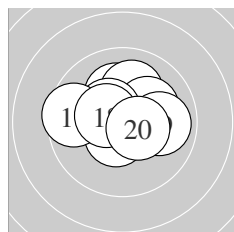

Serie 2:
 10.2 * 10.1 ↗ 10.2 * 10.4 * 10.6 *
 10.5 * 9.6 ← 10.5 * 9.9 → 10.5 *
 beste Teiler 87.0 (15.) 101.0 (16.) 116.2 (20.)
 Trefferlage 0.13 mm links, 0.53 mm hoch
 Streuwert 1.39, horizontal: 1.71, vertikal: 0.97

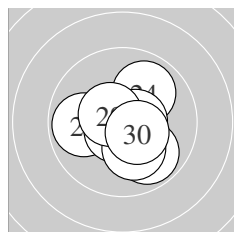

Serie 3:
 9.9 ← 10.7 * 9.9 ↘ 9.9 ↗ 10.5 *
 10.6 * 10.6 * 10.2 * 10.5 * 10.5 *
 beste Teiler 72.8 (22.) 77.0 (27.) 91.1 (26.)
 Trefferlage 0.25 mm rechts, 0.44 mm tief
 Streuwert 1.26, horizontal: 1.32, vertikal: 1.19

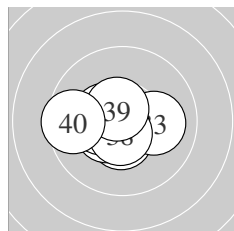

Serie 4:
 10.6 * 10.5 * 10.1 → 10.7 * 10.4 *
 10.4 * 10.4 * 10.6 * 10.6 * 9.6 ←
 beste Teiler 74.7 (34.) 86.0 (31.) 89.4 (38.)
 Trefferlage 0.61 mm links, 0.33 mm tief
 Streuwert 1.11, horizontal: 1.43, vertikal: 0.63

Unterschrift des Schützen

Meyton Elektronik

Ergebnis: **412.6** (392)
 Serien: 104.3 102.7 101.6 104.0
 Zähler: 32 8 0 0 0 0 0 0 0 0
 Innenzehner: 26
 weiteste: 418 (7), 396 (21), 364 (33)
 beste Teiler 9.0 (31.) 36.8 (25.) 44.0 (8.)
 Trefferlage 0.04 mm links, 0.10 mm tief
 Streuwert 1.36, horizontal: 1.78, vertikal: 0.71

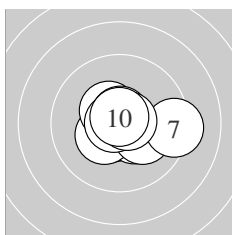
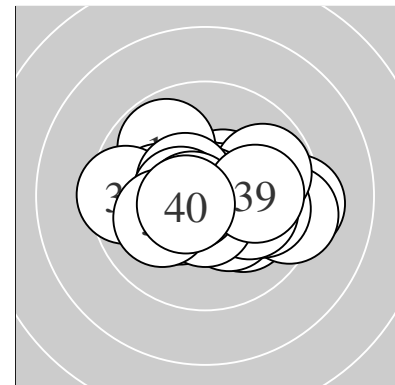

Serie 1:
 10.6 * 10.4 * 10.4 * 10.4 * 10.2 *
 10.7 * 9.3 → 10.8 * 10.7 * 10.8 *
 beste Teiler 44.0 (8.) 48.0 (10.) 58.2 (6.)
 Trefferlage 0.46 mm rechts, 0.15 mm tief
 Streuwert 1.22, horizontal: 1.58, vertikal: 0.69

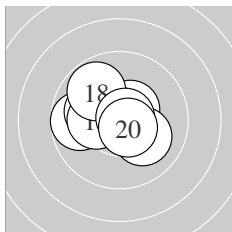

Serie 2:
 10.2 * 9.7 ← 10.5 * 10.1 ↖ 10.1 ↘
 10.7 * 10.2 * 9.8 ↘ 10.8 * 10.6 *
 beste Teiler 47.0 (19.) 66.6 (16.) 85.7 (20.)
 Trefferlage 0.72 mm links, 0.27 mm hoch
 Streuwert 1.28, horizontal: 1.57, vertikal: 0.90

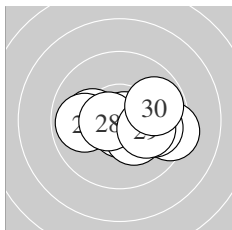

Serie 3:
 9.4 → 9.9 → 10.1 ← 10.7 * 10.8 *
 9.9 ← 10.3 * 10.6 * 10.1 → 9.8 →
 beste Teiler 36.8 (25.) 63.6 (24.) 87.5 (28.)
 Trefferlage 0.70 mm rechts, 0.31 mm tief
 Streuwert 1.58, horizontal: 2.14, vertikal: 0.63

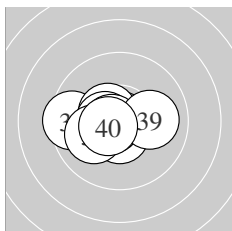

Serie 4:
 10.9 * 10.7 * 9.5 ← 10.5 * 10.5 *
 10.5 * 10.1 ← 10.7 * 10.0 → 10.6 *
 beste Teiler 9.0 (31.) 55.7 (32.) 63.5 (38.)
 Trefferlage 0.62 mm links, 0.21 mm tief
 Streuwert 1.16, horizontal: 1.56, vertikal: 0.51

Unterschrift des Schützen

Meyton Elektronik

Ergebnis: **408.3** (389)
 Serien: 99.8 104.6 102.0 101.9
 Zähler: 29 11 0 0 0 0 0 0 0 0
 Innenzehner: 24
 weiteste: 377 (10), 374 (9), 321 (37)
 beste Teiler 13.0 (35.) 50.2 (19.) 60.4 (14.)
 Trefferlage 0.03 mm links, 0.53 mm hoch
 Streuwert 1.44, horizontal: 1.75, vertikal: 1.04

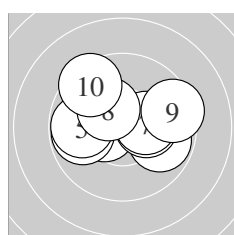
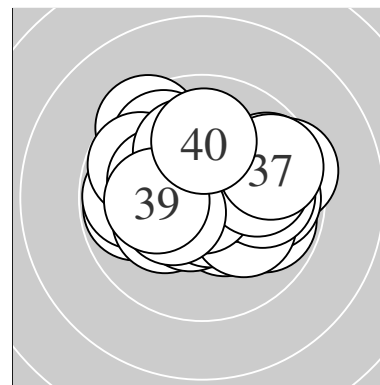

Serie 1:
 10.4 * 9.8 → 10.2 * 9.8 ← 9.8 ←
 10.3 * 10.3 * 10.3 * 9.5 → 9.4 ↗
 beste Teiler 129.7 (1.) 163.0 (8.) 166.7 (7.)
 Trefferlage 0.20 mm links, 0.57 mm hoch
 Streuwert 1.86, horizontal: 2.37, vertikal: 1.15

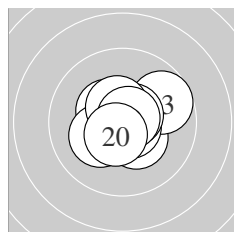

Serie 2:
 10.4 * 10.4 * 9.7 ↗ 10.7 * 10.7 *
 10.6 * 10.2 * 10.5 * 10.8 * 10.6 *
 beste Teiler 50.2 (19.) 60.4 (14.) 71.0 (15.)
 Trefferlage 0.10 mm rechts, 0.06 mm hoch
 Streuwert 1.08, horizontal: 1.24, vertikal: 0.88

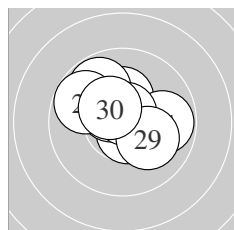

Serie 3:
 10.6 * 10.3 * 10.0 ↘ 9.8 → 9.8 ↘
 10.5 * 9.8 ↖ 10.7 * 10.1 ↘ 10.4 *
 beste Teiler 61.9 (28.) 79.6 (21.) 117.3 (26.)
 Trefferlage 0.26 mm links, 0.77 mm hoch
 Streuwert 1.41, horizontal: 1.66, vertikal: 1.11

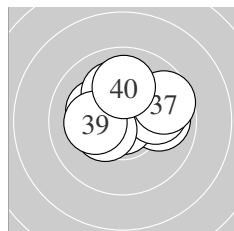

Serie 4:
 10.5 * 10.2 * 9.9 → 10.1 ↑ 10.9 *
 10.0 → 9.7 → 10.4 * 10.2 * 10.0 ↑
 beste Teiler 13.0 (35.) 110.3 (31.) 137.7 (38.)
 Trefferlage 0.23 mm rechts, 0.74 mm hoch
 Streuwert 1.45, horizontal: 1.80, vertikal: 0.98

Unterschrift des Schützen

Ergebnis: **410.6** (393)
 Serien: 101.9 101.6 104.6 102.5
 Zähler: 33 7 0 0 0 0 0 0 0 0
 Innenzehner: 27
 weiteste: 445 (5), 387 (15), 355 (36)
 beste Teiler 43.1 (3.) 44.0 (12.) 56.8 (22.)
 Trefferlage 0.09 mm links, 0.15 mm hoch
 Streuwert 1.42, horizontal: 1.67, vertikal: 1.11

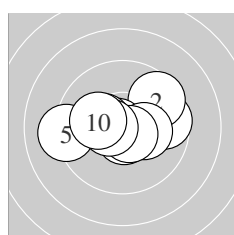
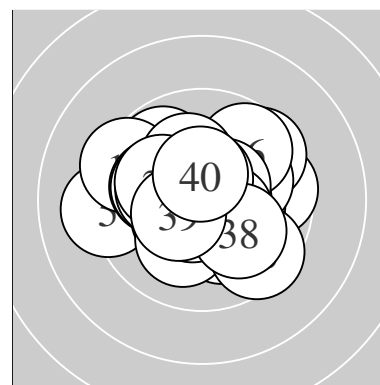

Serie 1:
 9.6 → 9.6 ↗ 10.8 * 10.3 * 9.2 ←
 10.3 * 10.7 * 10.7 * 10.5 * 10.2 *
 beste Teiler 43.1 (3.) 71.0 (7.) 75.6 (8.)
 Trefferlage 0.11 mm links, 0.15 mm hoch
 Streuwert 1.73, horizontal: 2.30, vertikal: 0.82

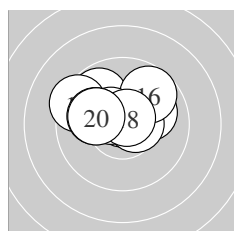

Serie 2:
 10.0 → 10.8 * 10.5 * 9.8 ↘ 9.4 ↘
 9.7 ↗ 10.5 * 10.7 * 10.1 ← 10.1 ←
 beste Teiler 44.0 (12.) 60.4 (18.) 102.0 (13.)
 Trefferlage 0.50 mm links, 0.99 mm hoch
 Streuwert 1.45, horizontal: 1.90, vertikal: 0.78

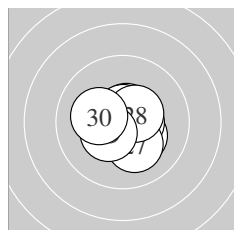

Serie 3:
 10.5 * 10.7 * 10.6 * 10.3 * 10.7 *
 10.5 * 10.2 * 10.5 * 10.4 * 10.2 *
 beste Teiler 56.8 (22.) 71.2 (25.) 85.0 (23.)
 Trefferlage 0.19 mm rechts, 0.25 mm tief
 Streuwert 0.96, horizontal: 1.02, vertikal: 0.90

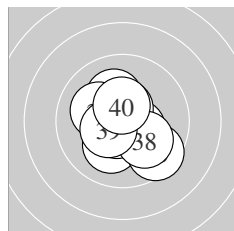

Serie 4:
 10.2 * 10.1 ↙ 10.5 * 10.1 ↘ 10.6 *
 9.5 ↘ 10.6 * 10.0 ↘ 10.4 * 10.5 *
 beste Teiler 83.2 (37.) 99.2 (35.) 122.2 (40.)
 Trefferlage 0.04 mm rechts, 0.27 mm tief
 Streuwert 1.41, horizontal: 1.38, vertikal: 1.44

Unterschrift des Schützen

Meyton Elektronik

Ergebnis: **404.6** (385)
 Serien: 100.1 101.4 102.0 101.1
 Zähler: 25 15 0 0 0 0 0 0 0 0
 Innenzehner: 18
 weiteste: 441 (25), 389 (5), 378 (9)
 beste Teiler 35.1 (36.) 52.4 (28.) 54.0 (26.)
 Trefferlage 0.22 mm rechts, 0.37 mm tief
 Streuwert 1.63, horizontal: 1.68, vertikal: 1.58

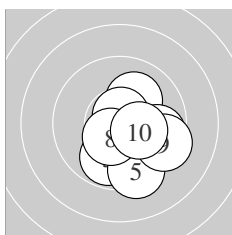
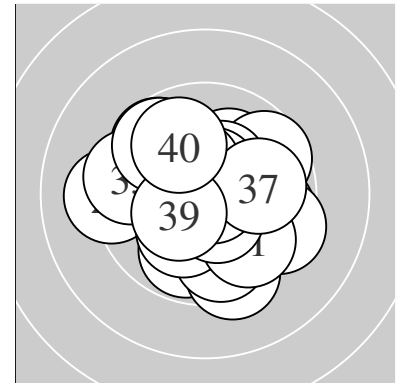

Serie 1:
 9.9 ↘ 10.1 ↗ 9.8 ↓ 10.4 * 9.4 ↓
 10.7 * 9.7 → 10.4 * 9.4 → 10.3 *
 beste Teiler 58.8 (6.) 126.7 (8.) 150.2 (4.)
 Trefferlage 1.12 mm rechts, 1.12 mm tief
 Streuwert 1.48, horizontal: 1.42, vertikal: 1.54

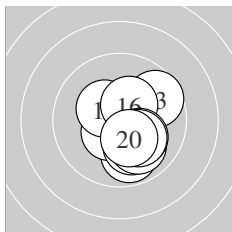

Serie 2:
 9.8 ↓ 10.5 * 9.7 ↗ 10.4 * 10.1 ↓
 10.4 * 10.0 ↓ 10.1 ↘ 10.1 ↓ 10.3 *
 beste Teiler 121.3 (12.) 141.5 (16.) 148.2 (14.)
 Trefferlage 0.84 mm rechts, 0.80 mm tief
 Streuwert 1.34, horizontal: 1.14, vertikal: 1.51

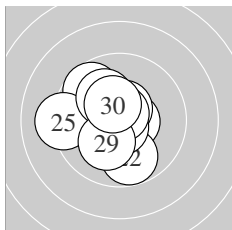

Serie 3:
 10.6 * 9.8 ↓ 10.6 * 9.7 ↖ 9.2 ←
 10.7 * 10.1 ↖ 10.7 * 10.2 * 10.4 *
 beste Teiler 52.4 (28.) 54.0 (26.) 93.6 (21.)
 Trefferlage 0.72 mm links, 0.14 mm hoch
 Streuwert 1.59, horizontal: 1.61, vertikal: 1.56

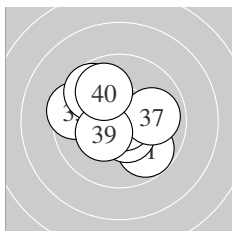

Serie 4:
 9.8 ↘ 10.6 * 10.5 * 10.1 ↖ 9.5 ←
 10.8 * 9.9 → 9.7 ↖ 10.3 * 9.9 ↖
 beste Teiler 35.1 (36.) 89.9 (32.) 115.9 (33.)
 Trefferlage 0.35 mm links, 0.25 mm hoch
 Streuwert 1.70, horizontal: 1.91, vertikal: 1.46

Unterschrift des Schützen

Ergebnis: **397.6** (380)
 Serien: 95.1 99.0 101.0 102.5
 Zähler: 23 15 1 1 0 0 0 0 0 0
 Innenzehner: 18
 weiteste: 971 (8), 555 (15), 427 (4)
 beste Teiler 41.0 (35.) 44.7 (11.) 52.4 (37.)
 Trefferlage 0.20 mm links, 0.15 mm hoch
 Streuwert 2.15, horizontal: 2.78, vertikal: 1.22

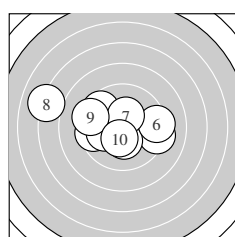
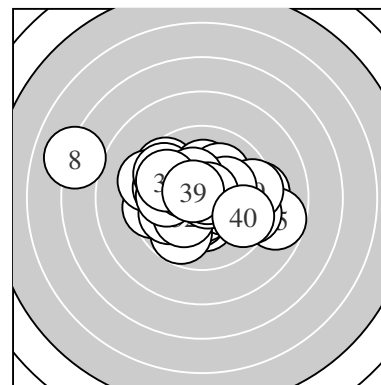

Serie 1:
 9.6 ↘ 9.5 ← 10.0 ← 9.2 → 10.3 *
 9.3 → 10.4 * 7.1 ← 9.3 ↖ 10.4 *
 beste Teiler 140.2 (10.) 146.2 (7.) 164.8 (5.)
 Trefferlage 1.30 mm links, 0.27 mm hoch
 Streuwert 3.03, horizontal: 3.99, vertikal: 1.58

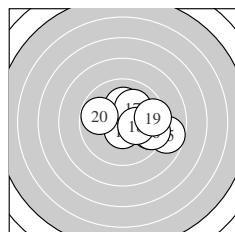

Serie 2:
 10.8 * 9.5 → 10.6 * 10.2 * 8.7 →
 9.5 → 10.1 ↗ 10.3 * 9.5 → 9.8 ←
 beste Teiler 44.7 (11.) 96.0 (13.) 171.2 (18.)
 Trefferlage 1.65 mm rechts, 0.01 mm tief
 Streuwert 1.89, horizontal: 2.38, vertikal: 1.23

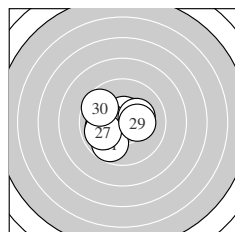

Serie 3:
 9.8 ↙ 10.1 ↖ 10.5 * 10.6 * 10.0 ←
 10.1 ← 9.9 ← 10.2 * 10.2 * 9.6 ↖
 beste Teiler 88.9 (24.) 124.3 (23.) 178.1 (29.)
 Trefferlage 0.83 mm links, 0.08 mm hoch
 Streuwert 1.54, horizontal: 1.81, vertikal: 1.23

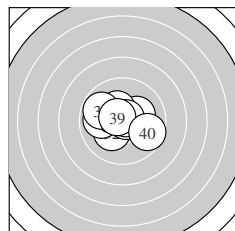

Serie 4:
 10.2 * 10.2 * 9.9 ← 10.4 * 10.8 *
 10.3 * 10.7 * 9.8 ↖ 10.6 * 9.6 →
 beste Teiler 41.0 (35.) 52.4 (37.) 80.8 (39.)
 Trefferlage 0.34 mm links, 0.25 mm hoch
 Streuwert 1.42, horizontal: 1.78, vertikal: 0.95

Unterschrift des Schützen

Meyton Elektronik

Ergebnis: **411.7** (391)
 Serien: 101.4 103.8 103.5 103.0
 Zähler: 31 9 0 0 0 0 0 0 0 0
 Innenzehner: 27
 weiteste: 392 (9), 327 (6), 309 (8)
 beste Teiler 32.6 (15.) 34.4 (17.) 35.5 (4.)
 Trefferlage 0.70 mm rechts, 0.60 mm tief
 Streuwert 1.18, horizontal: 1.09, vertikal: 1.27

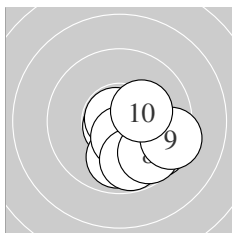
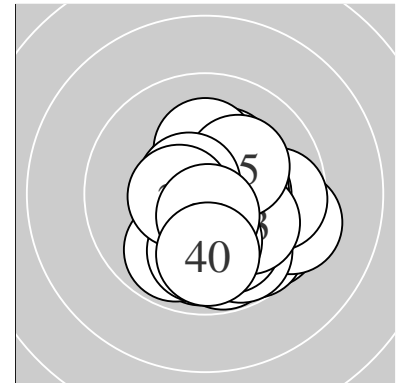

Serie 1:
 10.7 * 9.9 ↓ 10.7 * 10.8 * 10.5 *
 9.6 ↘ 9.8 ↓ 9.7 ↘ 9.4 → 10.3 *
 beste Teiler 35.5 (4.) 57.3 (1.) 62.0 (3.)
 Trefferlage 1.03 mm rechts, 1.19 mm tief
 Streuwert 1.32, horizontal: 1.43, vertikal: 1.19

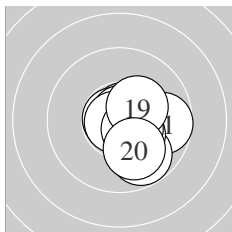

Serie 2:
 9.7 → 10.7 * 10.8 * 9.8 ↘ 10.8 *
 10.4 * 10.8 * 10.5 * 10.3 * 10.0 ↓
 beste Teiler 32.6 (15.) 34.4 (17.) 47.2 (13.)
 Trefferlage 0.85 mm rechts, 0.48 mm tief
 Streuwert 1.07, horizontal: 1.03, vertikal: 1.11

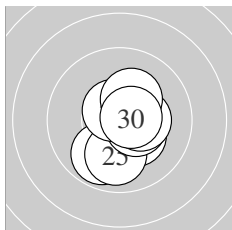

Serie 3:
 10.5 * 10.3 * 10.5 * 9.9 ✓ 10.0 ↓
 10.5 * 10.6 * 10.3 * 10.3 * 10.6 *
 beste Teiler 83.7 (27.) 85.3 (30.) 110.0 (23.)
 Trefferlage 0.52 mm rechts, 0.51 mm tief
 Streuwert 1.10, horizontal: 0.89, vertikal: 1.28

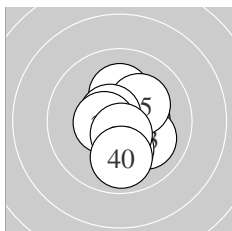

Serie 4:
 10.4 * 10.4 * 10.1 ↘ 10.2 * 10.2 *
 10.6 * 10.1 ↓ 10.5 * 10.6 * 9.9 ↓
 beste Teiler 81.6 (36.) 95.7 (39.) 112.5 (38.)
 Trefferlage 0.40 mm rechts, 0.22 mm tief
 Streuwert 1.24, horizontal: 0.95, vertikal: 1.47

Unterschrift des Schützen

Meyton Elektronik

Ergebnis: **407.3** (388)
 Serien: 100.7 101.6 102.2 102.8
 Zähler: 29 10 1 0 0 0 0 0 0 0
 Innenzehner: 24
 weiteste: 542 (5), 408 (16), 384 (6)
 beste Teiler 35.9 (4.) 42.2 (35.) 63.7 (11.)
 Trefferlage 0.18 mm links, 0.15 mm hoch
 Streuwert 1.58, horizontal: 1.99, vertikal: 1.02

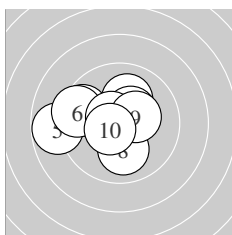
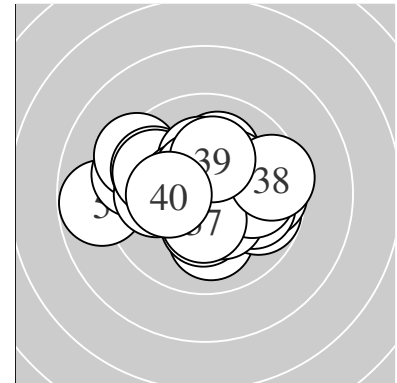

Serie 1:
 10.1 ↑ 9.6 ↖ 10.4 * 10.8 * 8.8 ←
 9.4 ↖ 10.6 * 10.0 ↓ 10.4 * 10.6 *
 beste Teiler 35.9 (4.) 90.2 (7.) 98.7 (10.)
 Trefferlage 1.09 mm links, 0.29 mm hoch
 Streuwert 1.81, horizontal: 2.26, vertikal: 1.20

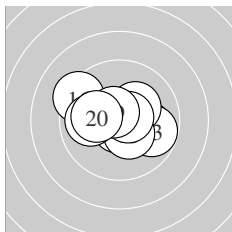

Serie 2:
 10.7 * 10.0 → 9.8 → 10.2 * 10.4 *
 9.3 ↖ 10.6 * 9.9 ← 10.6 * 10.1 ←
 beste Teiler 63.7 (11.) 77.4 (17.) 86.4 (19.)
 Trefferlage 0.07 mm links, 0.10 mm hoch
 Streuwert 1.64, horizontal: 2.10, vertikal: 0.98

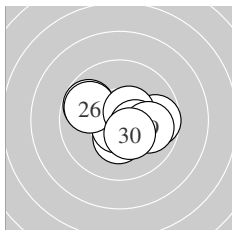

Serie 3:
 10.3 * 9.7 → 10.7 * 9.8 ↖ 10.7 *
 9.8 ↖ 10.5 * 10.4 * 9.9 → 10.4 *
 beste Teiler 66.0 (25.) 67.0 (23.) 108.3 (27.)
 Trefferlage 0.31 mm rechts, 0.20 mm tief
 Streuwert 1.50, horizontal: 1.89, vertikal: 0.96

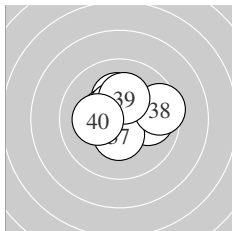

Serie 4:
 10.2 * 10.5 * 10.5 * 10.5 * 10.8 *
 10.0 → 10.4 * 9.5 → 10.2 * 10.2 *
 beste Teiler 42.2 (35.) 107.3 (34.) 113.5 (32.)
 Trefferlage 0.09 mm rechts, 0.44 mm hoch
 Streuwert 1.36, horizontal: 1.67, vertikal: 0.96

Unterschrift des Schützen

Ergebnis: **402.9** (386)
 Serien: 98.1 101.5 101.4 101.9
 Zähler: 26 14 0 0 0 0 0 0 0 0
 Innenzehner: 18
 weiteste: 500 (10), 471 (11), 398 (8)
 beste Teiler 9.4 (15.) 51.5 (3.) 67.8 (37.)
 Trefferlage 0.37 mm links, 0.70 mm hoch
 Streuwert 1.68, horizontal: 2.07, vertikal: 1.17

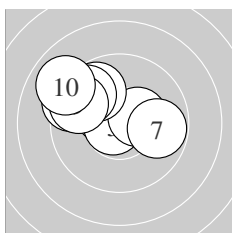
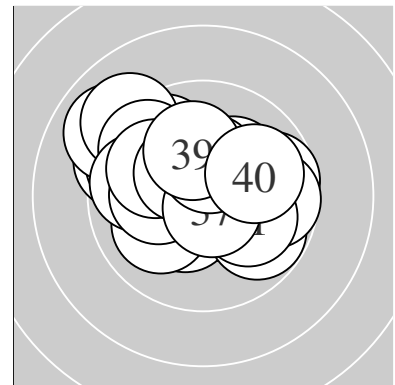

Serie 1:
 9.4 ↘ 10.4 * 10.7 * 10.4 * 9.8 ↖
 9.6 ↘ 9.8 → 9.4 ↘ 9.6 ↘ 9.0 ↘
 beste Teiler 51.5 (3.) 129.8 (2.) 144.2 (4.)
 Trefferlage 1.57 mm links, 1.31 mm hoch
 Streuwert 1.78, horizontal: 2.26, vertikal: 1.11

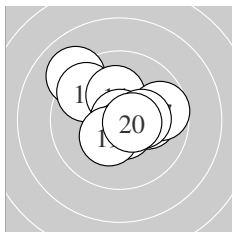

Serie 2:
 9.1 ↘ 10.1 → 9.6 ↘ 10.2 * 10.9 *
 10.6 * 9.7 → 10.3 * 10.4 * 10.6 *
 beste Teiler 9.4 (15.) 80.1 (16.) 96.6 (20.)
 Trefferlage 0.11 mm rechts, 0.61 mm hoch
 Streuwert 1.73, horizontal: 1.99, vertikal: 1.41

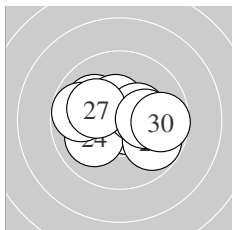

Serie 3:
 10.7 * 10.1 ↘ 10.5 * 10.0 ↙ 10.4 *
 9.8 ← 10.2 * 9.8 ↘ 10.2 * 9.7 →
 beste Teiler 75.6 (21.) 124.9 (23.) 144.6 (25.)
 Trefferlage 0.06 mm rechts, 0.12 mm hoch
 Streuwert 1.65, horizontal: 2.12, vertikal: 0.97

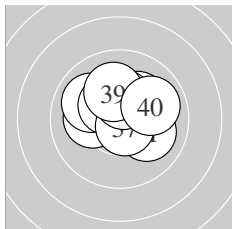

Serie 4:
 10.0 ↘ 10.1 ↘ 10.1 ← 10.0 ↘ 10.2 *
 10.4 * 10.7 * 10.4 * 10.1 ↑ 9.9 →
 beste Teiler 67.8 (37.) 138.9 (36.) 149.2 (38.)
 Trefferlage 0.11 mm links, 0.76 mm hoch
 Streuwert 1.37, horizontal: 1.69, vertikal: 0.95

Unterschrift des Schützen

Meyton Elektronik

Ergebnis: **406.3** (389)
 Serien: 102.4 100.1 101.5 102.3
 Zähler: 29 11 0 0 0 0 0 0 0 0
 Innenzehner: 25
 weiteste: 463 (33), 439 (23), 415 (31)
 beste Teiler 43.6 (32.) 49.8 (2.) 75.0 (29.)
 Trefferlage 0.13 mm links, 0.07 mm tief
 Streuwert 1.66, horizontal: 2.04, vertikal: 1.17

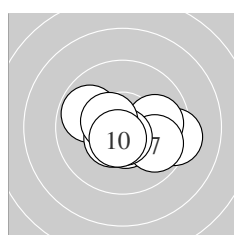
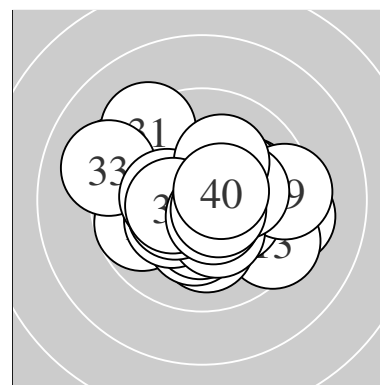

Serie 1:
 9.3 → 10.8 * 9.8 ↖ 10.6 * 10.5 *
 9.9 → 9.8 ↘ 10.6 * 10.5 * 10.6 *
 beste Teiler 49.8 (2.) 76.3 (8.) 95.8 (10.)
 Trefferlage 0.46 mm rechts, 0.42 mm tief
 Streuwert 1.50, horizontal: 1.98, vertikal: 0.76

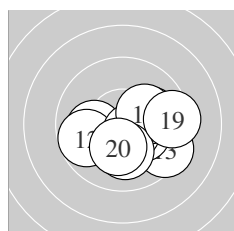

Serie 2:
 10.1 ← 9.7 ← 9.4 ↘ 10.3 * 10.6 *
 10.1 → 10.2 * 10.1 ↓ 9.4 → 10.2 *
 beste Teiler 92.7 (15.) 166.8 (14.) 181.4 (20.)
 Trefferlage 0.80 mm rechts, 0.66 mm tief
 Streuwert 1.72, horizontal: 2.18, vertikal: 1.08

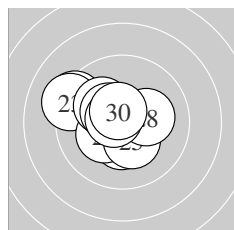

Serie 3:
 10.4 * 9.3 ↖ 9.2 ↖ 10.3 * 10.3 *
 10.1 ↖ 10.4 * 10.2 * 10.7 * 10.6 *
 beste Teiler 75.0 (29.) 93.7 (30.) 136.4 (27.)
 Trefferlage 1.05 mm links, 0.31 mm hoch
 Streuwert 1.55, horizontal: 1.83, vertikal: 1.20

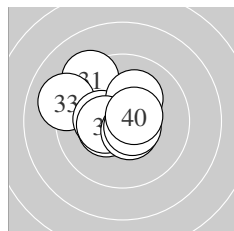

Serie 4:
 9.3 ↖ 10.8 * 9.1 ↖ 10.4 * 10.3 *
 10.2 * 10.4 * 10.6 * 10.6 * 10.6 *
 beste Teiler 43.6 (32.) 89.1 (39.) 94.8 (38.)
 Trefferlage 0.78 mm links, 0.47 mm hoch
 Streuwert 1.56, horizontal: 1.78, vertikal: 1.31

Unterschrift des Schützen

Meyton Elektronik

Ergebnis: **410.2** (391)
 Serien: 101.6 100.3 105.3 103.0
 Zähler: 32 7 1 0 0 0 0 0 0
 Innenzehner: 30
 weiteste: 735 (9), 417 (12), 411 (33)
 beste Teiler 2.2 (30.) 9.4 (37.) 19.1 (34.)
 Trefferlage 0.32 mm links, 0.16 mm hoch
 Streuwert 1.56, horizontal: 1.92, vertikal: 1.10

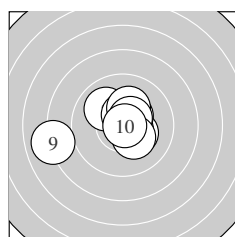
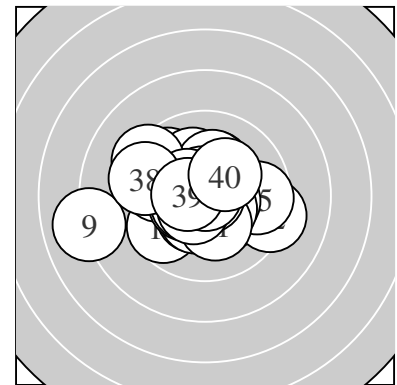

Serie 1:
 10.3 * 10.0 ↘ 10.5 * 10.5 * 10.4 *
 10.2 * 10.5 * 10.3 * 8.0 ← 10.9 *
 beste Teiler 22.8 (10.) 101.5 (4.) 106.3 (7.)
 Trefferlage 0.27 mm links, 0.18 mm hoch
 Streuwert 2.01, horizontal: 2.56, vertikal: 1.23

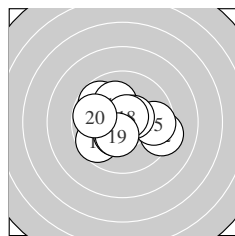

Serie 2:
 9.7 ↙ 9.3 → 10.4 * 9.7 ↘ 9.7 →
 10.1 ↖ 10.5 * 10.7 * 10.4 * 9.8 ←
 beste Teiler 69.4 (18.) 113.6 (17.) 142.3 (19.)
 Trefferlage 0.11 mm links, 0.00 mm
 Streuwert 1.91, horizontal: 2.33, vertikal: 1.37

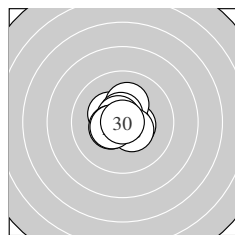

Serie 3:
 10.5 * 10.3 * 10.7 * 10.2 * 10.6 *
 10.7 * 10.4 * 10.5 * 10.5 * 10.9 *
 beste Teiler 2.2 (30.) 57.5 (23.) 64.3 (26.)
 Trefferlage 0.12 mm links, 0.16 mm hoch
 Streuwert 0.86, horizontal: 0.90, vertikal: 0.81

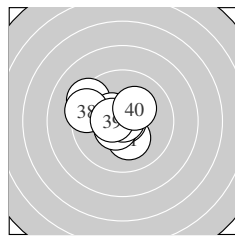

Serie 4:
 10.2 * 10.7 * 9.3 ↘ 10.9 * 10.4 *
 10.5 * 10.9 * 9.4 ← 10.5 * 10.2 *
 beste Teiler 9.4 (37.) 19.1 (34.) 54.1 (32.)
 Trefferlage 0.77 mm links, 0.33 mm hoch
 Streuwert 1.40, horizontal: 1.66, vertikal: 1.08

Unterschrift des Schützen

Meyton Elektronik

Ergebnis: **414.4** (395)
 Serien: 102.2 101.3 106.1 104.8
 Zähler: 35 5 0 0 0 0 0 0 0 0
 Innenzehner: 27
 weiteste: 425 (11), 358 (1), 353 (4)
 beste Teiler 4.0 (33.) 24.3 (30.) 29.0 (15.)
 Trefferlage 0.34 mm links, 0.24 mm tief
 Streuwert 1.24, horizontal: 1.59, vertikal: 0.74

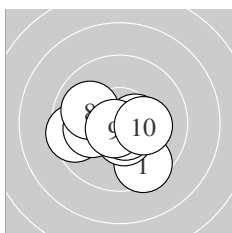
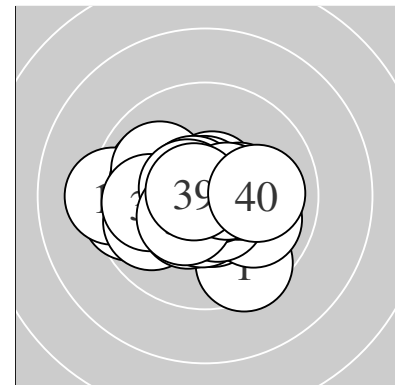

Serie 1:
 9.5 ↘ 10.5 * 10.5 * 9.5 ← 10.5 *
 10.1 ← 10.7 * 10.0 ↖ 10.7 * 10.2 *
 beste Teiler 58.0 (9.) 74.0 (7.) 109.4 (3.)
 Trefferlage 0.16 mm links, 0.59 mm tief
 Streuwert 1.50, horizontal: 1.85, vertikal: 1.03

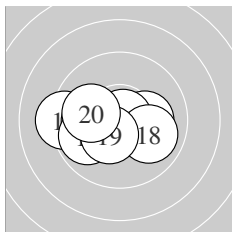

Serie 2:
 9.3 ← 10.2 * 10.6 * 10.0 ← 10.8 *
 10.1 ← 9.9 ← 10.0 ↘ 10.4 * 10.0 ←
 beste Teiler 29.0 (15.) 81.8 (13.) 137.0 (19.)
 Trefferlage 0.90 mm links, 0.36 mm tief
 Streuwert 1.55, horizontal: 2.12, vertikal: 0.59

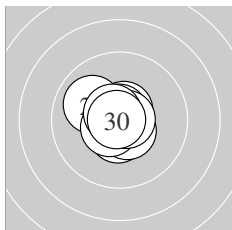

Serie 3:
 10.5 * 10.6 * 10.7 * 10.6 * 10.0 ↖
 10.6 * 10.7 * 10.8 * 10.7 * 10.9 *
 beste Teiler 24.3 (30.) 50.3 (28.) 53.1 (27.)
 Trefferlage 0.28 mm links, 0.02 mm hoch
 Streuwert 0.76, horizontal: 0.78, vertikal: 0.73

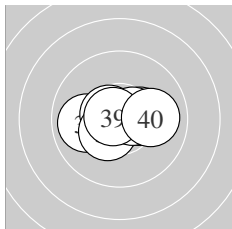

Serie 4:
 10.7 * 9.9 ← 10.9 * 10.8 * 10.3 *
 10.6 * 10.4 * 10.5 * 10.7 * 10.0 →
 beste Teiler 4.0 (33.) 30.5 (34.) 54.4 (39.)
 Trefferlage 0.02 mm links, 0.03 mm tief
 Streuwert 1.04, horizontal: 1.41, vertikal: 0.38

Unterschrift des Schützen

Meyton Elektronik

Ergebnis: **414.8** (395)
 Serien: 102.5 104.1 104.4 103.8
 Zähler: 35 5 0 0 0 0 0 0 0 0
 Innenzehner: 31
 weiteste: 280 (11), 276 (27), 263 (8)
 beste Teiler 8.0 (16.) 14.8 (33.) 28.6 (28.)
 Trefferlage 0.07 mm links, 0.15 mm tief
 Streuwert 1.16, horizontal: 1.25, vertikal: 1.07

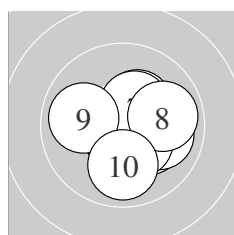
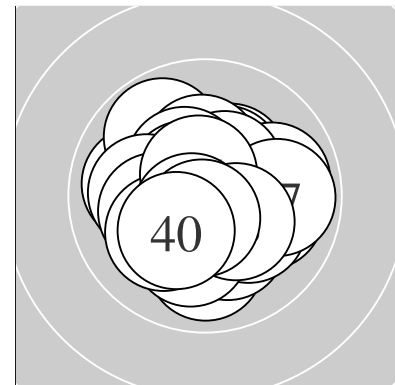

Serie 1:
 10.2 * 10.0 → 10.4 * 10.7 * 10.3 *
 10.8 * 10.4 * 9.9 → 9.9 ← 9.9 ↓
 beste Teiler 40.1 (6.) 61.7 (4.) 143.7 (7.)
 Trefferlage 0.59 mm rechts, 0.20 mm tief
 Streuwert 1.34, horizontal: 1.50, vertikal: 1.17

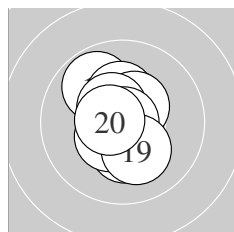

Serie 2:
 9.8 ↖ 10.5 * 10.3 * 10.5 * 10.5 *
 10.9 * 10.3 * 10.5 * 10.2 * 10.6 *
 beste Teiler 8.0 (16.) 84.0 (20.) 115.0 (15.)
 Trefferlage 0.17 mm links, 0.27 mm hoch
 Streuwert 1.12, horizontal: 0.82, vertikal: 1.37

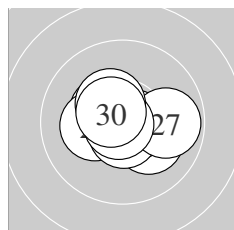

Serie 3:
 10.2 * 10.7 * 10.6 * 10.4 * 10.2 *
 10.7 * 9.8 → 10.8 * 10.4 * 10.6 *
 beste Teiler 28.6 (28.) 69.0 (22.) 71.4 (26.)
 Trefferlage 0.01 mm links, 0.00 mm
 Streuwert 1.09, horizontal: 1.38, vertikal: 0.67

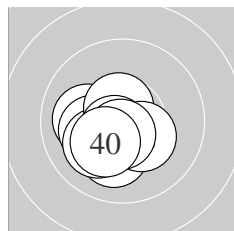

Serie 4:
 10.1 ↓ 10.1 ← 10.9 * 10.2 * 10.1 ↙
 10.6 * 10.6 * 10.3 * 10.6 * 10.3 *
 beste Teiler 14.8 (33.) 80.1 (37.) 85.9 (39.)
 Trefferlage 0.72 mm links, 0.68 mm tief
 Streuwert 0.92, horizontal: 1.01, vertikal: 0.83

Unterschrift des Schützen

Meyton Elektronik

Ergebnis: **414.4** (397)
 Serien: 103.4 103.2 103.2 104.6
 Zähler: 37 3 0 0 0 0 0 0 0 0
 Innenzehner: 30
 weiteste: 300 (20), 297 (32), 276 (23)
 beste Teiler 51.9 (29.) 57.9 (36.) 62.1 (27.)
 Trefferlage 0.31 mm links, 0.29 mm hoch
 Streuwert 1.12, horizontal: 1.29, vertikal: 0.92

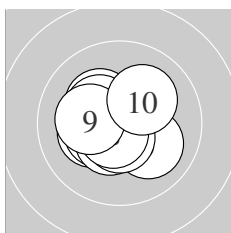
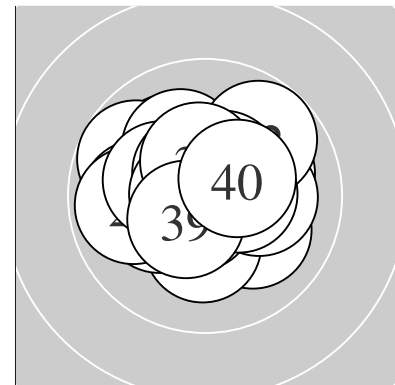

Serie 1:
 10.3 * 10.3 * 10.1 ↘ 10.2 * 10.4 *
 10.5 * 10.6 * 10.7 * 10.2 * 10.1 ↗
 beste Teiler 74.6 (8.) 93.0 (7.) 123.6 (6.)
 Trefferlage 0.51 mm links, 0.12 mm tief
 Streuwert 1.15, horizontal: 1.28, vertikal: 1.01

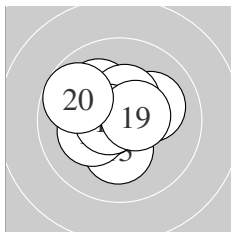

Serie 2:
 10.1 ↘ 10.6 * 10.2 * 10.6 * 10.2 *
 10.1 ↗ 10.4 * 10.7 * 10.5 * 9.8 ↖
 beste Teiler 67.1 (18.) 84.2 (14.) 97.3 (12.)
 Trefferlage 0.32 mm links, 0.35 mm hoch
 Streuwert 1.24, horizontal: 1.39, vertikal: 1.07

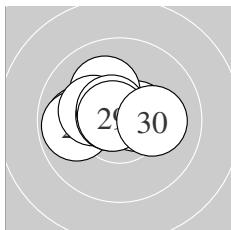

Serie 3:
 10.0 ← 10.5 * 9.8 ← 10.5 * 10.1 ↘
 10.2 * 10.7 * 10.6 * 10.7 * 10.1 →
 beste Teiler 51.9 (29.) 62.1 (27.) 81.6 (28.)
 Trefferlage 0.70 mm links, 0.41 mm hoch
 Streuwert 1.12, horizontal: 1.46, vertikal: 0.61

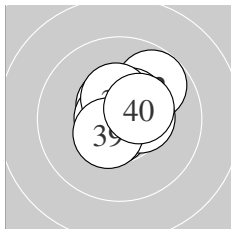

Serie 4:
 10.7 * 9.8 ↗ 10.5 * 10.5 * 10.7 *
 10.7 * 10.4 * 10.4 * 10.5 * 10.4 *
 beste Teiler 57.9 (36.) 66.3 (35.) 71.1 (31.)
 Trefferlage 0.29 mm rechts, 0.52 mm hoch
 Streuwert 0.94, horizontal: 0.97, vertikal: 0.91

Unterschrift des Schützen

Ergebnis: **410.1** (394)
 Serien: 102.0 101.2 102.8 104.1
 Zähler: 35 4 1 0 0 0 0 0 0
 Innenzehner: 25
 weiteste: 526 (4), 342 (20), 283 (22)
 beste Teiler 17.7 (38.) 40.3 (28.) 59.0 (26.)
 Trefferlage 0.30 mm rechts, 0.05 mm tief
 Streuwert 1.40, horizontal: 1.50, vertikal: 1.29

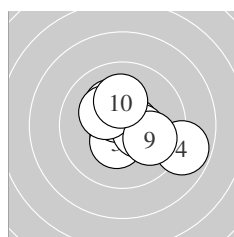
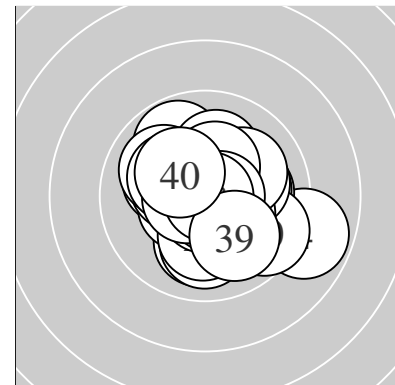

Serie 1:
 10.6 * 10.6 * 10.4 * 8.8 ↘ 10.2 *
 10.6 * 10.4 * 10.3 * 9.9 ↘ 10.2 *
 beste Teiler 78.1 (1.) 89.6 (2.) 90.7 (6.)
 Trefferlage 0.54 mm rechts, 0.00 mm
 Streuwert 1.63, horizontal: 1.90, vertikal: 1.32

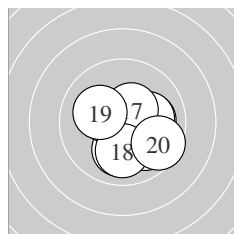

Serie 2:
 9.9 ↘ 10.6 * 10.1 → 10.0 ↓ 10.1 →
 10.3 * 10.5 * 10.0 ↓ 10.1 ↖ 9.6 ↘
 beste Teiler 93.3 (12.) 124.2 (17.) 152.8 (16.)
 Trefferlage 0.68 mm rechts, 0.59 mm tief
 Streuwert 1.48, horizontal: 1.61, vertikal: 1.33

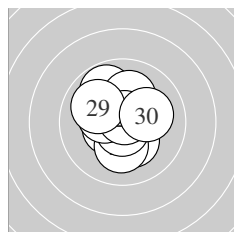

Serie 3:
 10.3 * 9.8 ↘ 10.5 * 10.2 * 10.1 ↑
 10.7 * 10.3 * 10.8 * 10.0 ↖ 10.1 →
 beste Teiler 40.3 (28.) 59.0 (26.) 121.3 (23.)
 Trefferlage 0.26 mm links, 0.27 mm hoch
 Streuwert 1.34, horizontal: 1.23, vertikal: 1.45

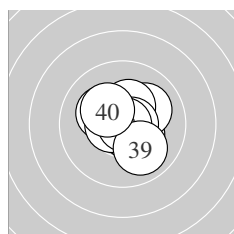

Serie 4:
 10.3 * 10.7 * 10.1 ↗ 10.2 * 10.3 *
 10.6 * 10.7 * 10.9 * 10.0 ↘ 10.3 *
 beste Teiler 17.7 (38.) 69.8 (32.) 73.0 (37.)
 Trefferlage 0.25 mm rechts, 0.11 mm hoch
 Streuwert 1.13, horizontal: 1.18, vertikal: 1.09

Unterschrift des Schützen

Meyton Elektronik

Ergebnis: **414.6** (396)
 Serien: 103.8 102.2 104.7 103.9
 Zähler: 36 4 0 0 0 0 0 0 0 0
 Innenzehner: 29
 weiteste: 354 (13), 270 (39), 252 (17)
 beste Teiler 3.6 (38.) 48.0 (30.) 50.2 (23.)
 Trefferlage 0.07 mm rechts, 0.02 mm hoch
 Streuwert 1.19, horizontal: 1.42, vertikal: 0.90

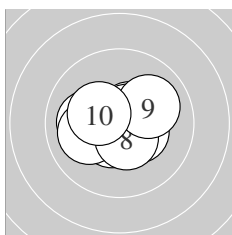
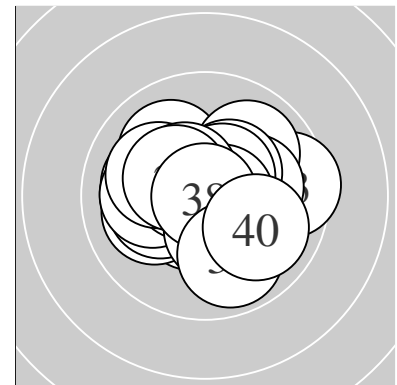

Serie 1:
 10.1 ← 10.6 * 10.5 * 10.1 ← 10.4 *
 10.6 * 10.7 * 10.5 * 10.0 ↗ 10.3 *
 beste Teiler 75.7 (7.) 78.4 (2.) 96.8 (6.)
 Trefferlage 0.18 mm links, 0.06 mm tief
 Streuwert 1.15, horizontal: 1.43, vertikal: 0.78

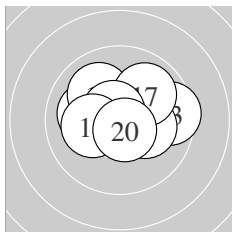

Serie 2:
 10.5 * 10.1 ← 9.5 → 10.5 * 10.2 *
 10.0 ↘ 9.9 ↗ 10.7 * 10.2 * 10.6 *
 beste Teiler 70.4 (18.) 77.8 (20.) 114.5 (11.)
 Trefferlage 0.14 mm rechts, 0.41 mm hoch
 Streuwert 1.46, horizontal: 1.88, vertikal: 0.86

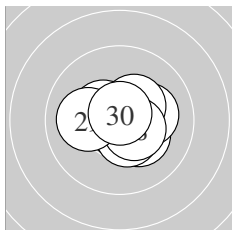

Serie 3:
 10.7 * 10.3 * 10.8 * 10.2 * 10.4 *
 10.4 * 10.5 * 10.5 * 10.1 ← 10.8 *
 beste Teiler 48.0 (30.) 50.2 (23.) 62.3 (21.)
 Trefferlage 0.31 mm rechts, 0.08 mm tief
 Streuwert 1.00, horizontal: 1.23, vertikal: 0.71

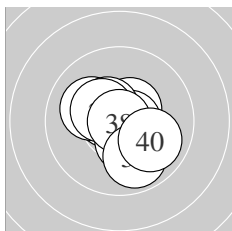

Serie 4:
 10.5 * 10.6 * 10.1 ↖ 10.4 * 10.7 *
 10.5 * 10.4 * 10.9 * 9.9 ↓ 9.9 ↘
 beste Teiler 3.6 (38.) 68.2 (35.) 92.1 (32.)
 Trefferlage 0.01 mm rechts, 0.16 mm tief
 Streuwert 1.21, horizontal: 1.24, vertikal: 1.18

Unterschrift des Schützen

Ergebnis: **413.5** (398)
 Serien: 102.8 103.2 102.1 105.4
 Zähler: 38 2 0 0 0 0 0 0 0 0
 Innenzehner: 27
 weiteste: 443 (12), 344 (23), 238 (25)
 beste Teiler 23.8 (8.) 24.1 (19.) 33.0 (39.)
 Trefferlage 0.03 mm rechts, 0.13 mm tief
 Streuwert 1.26, horizontal: 1.36, vertikal: 1.16

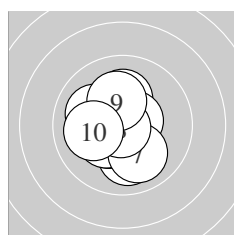
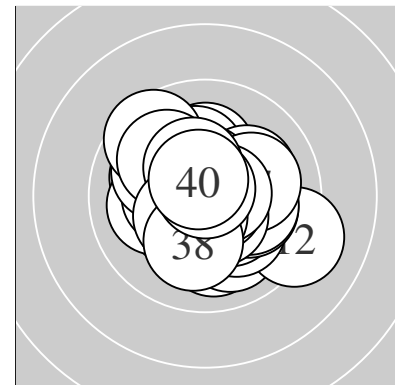

Serie 1:
 10.0 ↓ 10.4 * 10.3 * 10.1 ↖ 10.2 *
 10.6 * 10.0 ↘ 10.9 * 10.2 * 10.1 ←
 beste Teiler 23.8 (8.) 88.7 (6.) 142.8 (2.)
 Trefferlage 0.47 mm links, 0.20 mm tief
 Streuwert 1.31, horizontal: 1.14, vertikal: 1.46

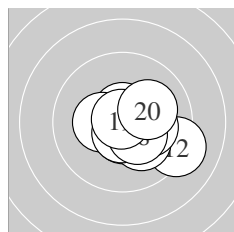

Serie 2:
 10.6 * 9.2 ↗ 10.2 * 10.7 * 10.3 *
 10.2 * 10.6 * 10.4 * 10.9 * 10.1 →
 beste Teiler 24.1 (19.) 73.0 (14.) 81.3 (17.)
 Trefferlage 0.87 mm rechts, 0.43 mm tief
 Streuwert 1.27, horizontal: 1.55, vertikal: 0.91

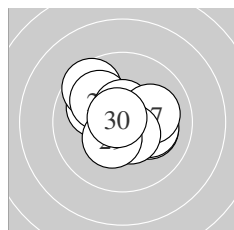

Serie 3:
 10.1 → 10.0 ↖ 9.6 ↖ 10.1 → 10.0 ↖
 10.6 * 10.1 → 10.5 * 10.4 * 10.7 *
 beste Teiler 53.4 (30.) 95.0 (26.) 108.7 (28.)
 Trefferlage 0.06 mm links, 0.41 mm hoch
 Streuwert 1.46, horizontal: 1.69, vertikal: 1.19

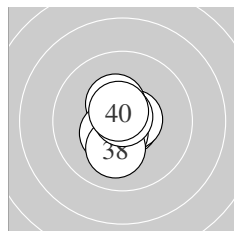

Serie 4:
 10.8 * 10.3 * 10.8 * 10.6 * 10.4 *
 10.6 * 10.4 * 10.1 ↓ 10.8 * 10.6 *
 beste Teiler 33.0 (39.) 34.4 (33.) 50.4 (31.)
 Trefferlage 0.19 mm links, 0.32 mm tief
 Streuwert 0.80, horizontal: 0.54, vertikal: 1.00

Unterschrift des Schützen

Ergebnis: **401.5** (385)
 Serien: 100.3 100.1 99.9 101.2
 Zähler: 26 13 1 0 0 0 0 0 0 0
 Innenzehner: 21
 weiteste: 519 (40), 473 (4), 410 (2)
 beste Teiler 57.4 (31.) 71.2 (5.) 76.5 (39.)
 Trefferlage 1.11 mm links, 0.32 mm tief
 Streuwert 1.65, horizontal: 1.86, vertikal: 1.41

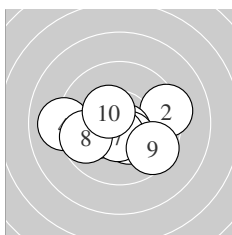
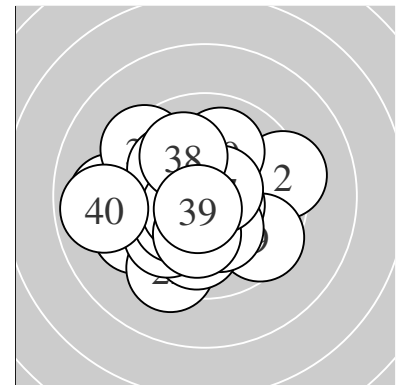

Serie 1:
 10.6 * 9.3 → 10.1 ← 9.1 ← 10.7 *
 10.4 * 10.5 * 9.7 ← 9.5 ↘ 10.4 *
 beste Teiler 71.2 (5.) 93.1 (1.) 103.2 (7.)
 Trefferlage 0.31 mm links, 0.57 mm tief
 Streuwert 1.94, horizontal: 2.56, vertikal: 0.99

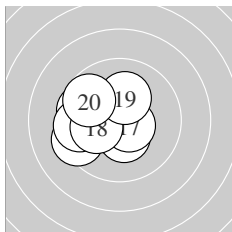

Serie 2:
 10.4 * 10.2 * 9.7 ↖ 9.4 ← 10.2 *
 9.6 ← 10.6 * 10.1 ← 10.2 * 9.7 ↗
 beste Teiler 92.2 (17.) 141.2 (11.) 179.7 (15.)
 Trefferlage 1.63 mm links, 0.15 mm hoch
 Streuwert 1.45, horizontal: 1.65, vertikal: 1.23

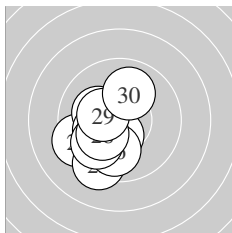

Serie 3:
 9.4 ← 9.3 ↓ 10.4 * 10.2 * 10.2 *
 9.9 ↓ 9.9 ↙ 10.2 * 10.4 * 10.0 ↑
 beste Teiler 132.2 (23.) 146.7 (29.) 187.0 (28.)
 Trefferlage 1.34 mm links, 0.98 mm tief
 Streuwert 1.47, horizontal: 1.17, vertikal: 1.71

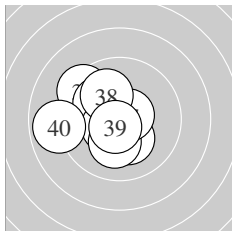

Serie 4:
 10.7 * 9.4 ↖ 10.1 ↖ 10.5 * 10.2 *
 10.2 * 10.6 * 10.0 ↖ 10.6 * 8.9 ←
 beste Teiler 57.4 (31.) 76.5 (39.) 78.2 (37.)
 Trefferlage 1.18 mm links, 0.09 mm hoch
 Streuwert 1.64, horizontal: 1.79, vertikal: 1.47

Unterschrift des Schützen

Meyton Elektronik

Ergebnis: **407.9** (390)
 Serien: 102.4 101.0 101.1 103.4
 Zähler: 30 10 0 0 0 0 0 0 0 0
 Innenzehner: 24
 weiteste: 354 (15), 352 (22), 342 (2)
 beste Teiler 44.2 (36.) 70.8 (21.) 80.4 (20.)
 Trefferlage 0.30 mm rechts, 0.37 mm hoch
 Streuwert 1.44, horizontal: 1.53, vertikal: 1.34

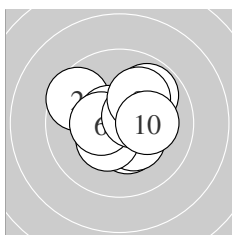
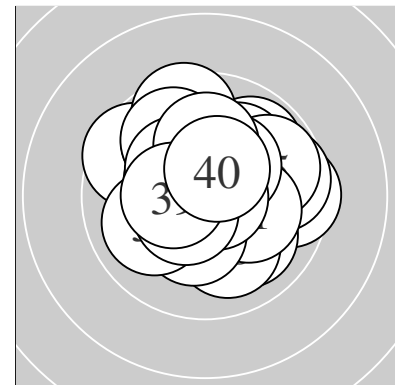

Serie 1:
 10.4 * 9.6 ↘ 10.4 * 10.4 * 10.6 *
 10.4 * 10.5 * 9.8 ↗ 10.1 ↗ 10.2 *
 beste Teiler 83.8 (5.) 108.6 (7.) 130.0 (6.)
 Trefferlage 0.19 mm rechts, 0.27 mm hoch
 Streuwert 1.43, horizontal: 1.60, vertikal: 1.24

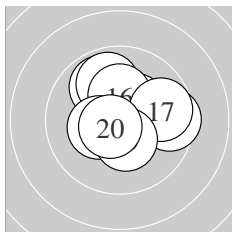

Serie 2:
 10.3 * 10.1 → 9.9 ↖ 9.9 ↖ 9.5 →
 10.3 * 9.7 → 10.3 * 10.4 * 10.6 *
 beste Teiler 80.4 (20.) 143.5 (19.) 152.7 (11.)
 Trefferlage 0.58 mm rechts, 0.63 mm hoch
 Streuwert 1.56, horizontal: 1.78, vertikal: 1.29

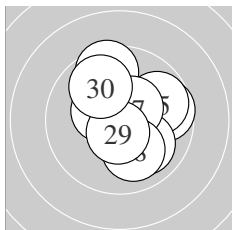

Serie 3:
 10.7 * 9.5 ↖ 9.7 → 10.4 * 9.8 ↗
 10.0 ↘ 10.5 * 10.0 ↘ 10.6 * 9.9 ↖
 beste Teiler 70.8 (21.) 87.8 (29.) 121.6 (27.)
 Trefferlage 0.63 mm rechts, 0.43 mm hoch
 Streuwert 1.63, horizontal: 1.55, vertikal: 1.71

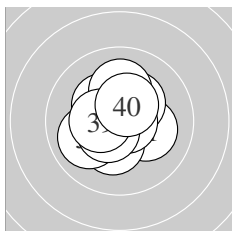

Serie 4:
 10.2 * 10.3 * 10.3 * 10.3 * 10.0 ↖
 10.8 * 10.1 ↑ 10.5 * 10.4 * 10.5 *
 beste Teiler 44.2 (36.) 107.1 (38.) 125.8 (40.)
 Trefferlage 0.20 mm links, 0.17 mm hoch
 Streuwert 1.21, horizontal: 1.21, vertikal: 1.21

Unterschrift des Schützen

Meyton Elektronik