

Ergebnis: 415.1 (394)
Serien: 104.2 104.2 104.5 102.2
Zähler: 34 6 0 0 0 0 0 0 0 0 0
Innenzehner: 32
Weiteste: 405 (40.), 377 (31.), 330 (30.)
beste Teiler: 6.4 (32.), 32.8 (7.), 34.9 (27.)
Trefferlage: 0.17 mm rechts, 0.10 mm hoch
Streuwert: 1.22, horizontal: 1.49, vertikal: 0.86

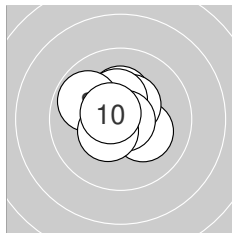
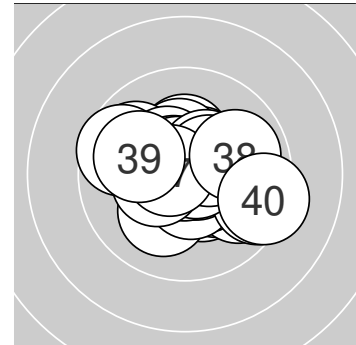

Serie 1: 104.2 (99)

10.2* ↘	10.3* ↑	10.6* ↑	10.4* ↗	10.6* ↖
10.4* ↑	10.8* ↘	9.9 ↘	10.4* ↖	10.6* ↖

beste Teiler: 32.8 (7.), 85.4 (5.), 86.0 (10.)
Trefferlage: 0.21 mm links, 0.58 mm hoch
Streuwert: 1.00, horizontal: 1.07, vertikal: 0.93

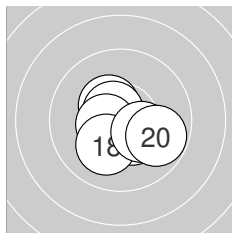

Serie 2: 104.2 (99)

10.4* ↘	10.8* ↖	10.7* ↖	10.6* ↖	10.4* ↖
10.6* ↖	10.5* ↖	10.1 ↘	10.3* ↘	9.8 ↘

beste Teiler: 48.6 (12.), 53.0 (13.), 84.2 (16.)
Trefferlage: 0.02 mm links, 0.24 mm tief
Streuwert: 1.11, horizontal: 1.26, vertikal: 0.93

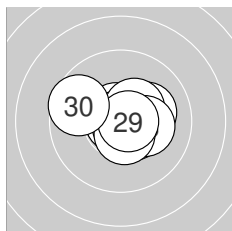

Serie 3: 104.5 (99)

10.7* ↖	10.5* ↘	10.2* →	10.8* ←	10.4* ↗
10.2* →	10.8* ↘	10.6* ↓	10.7* →	9.6 ↖

beste Teiler: 34.9 (27.), 37.3 (24.), 56.0 (29.)
Trefferlage: 0.28 mm rechts, 0.09 mm hoch
Streuwert: 1.12, horizontal: 1.42, vertikal: 0.70

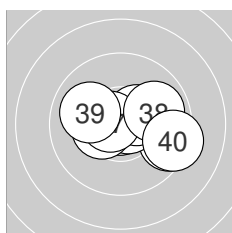

Serie 4: 102.2 (97)

9.4 ↘	10.9* ↗	10.6* ←	10.7* →	10.4* ←
10.4* ↗	10.6* ←	9.9 →	10.0 ↖	9.3 ↘

beste Teiler: 6.4 (32.), 54.3 (34.), 77.1 (37.)
Trefferlage: 0.63 mm rechts, 0.00 mm
Streuwert: 1.58, horizontal: 2.10, vertikal: 0.76



Ergebnis: 418.0 (399)
Serien: 103.2 104.5 105.1 105.2
Zähler: 39 1 0 0 0 0 0 0 0 0
Innenzehner: 34
Weiteste: 374 (5.), 246 (8.), 242 (26.)
beste Teiler: 25.9 (21.), 26.1 (19.), 45.6 (38.)
Trefferlage: 0.28 mm rechts, 0.03 mm hoch
Streuwert: 1.02, horizontal: 0.99, vertikal: 1.05

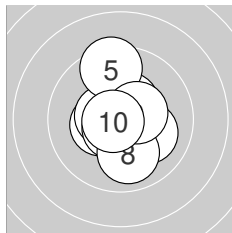
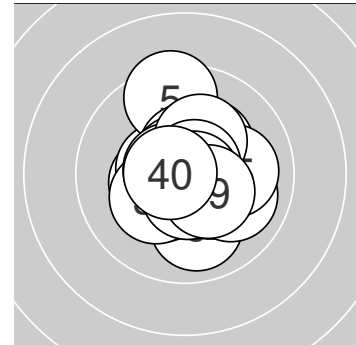

Serie 1: 103.2 (99)

10.4* ↑	10.5* ↗	10.4* ←	10.5* ←	9.5 ↑
10.1 ↘	10.6* ↘	10.0 ↓	10.5* →	10.7* ←

beste Teiler: 57.0 (10.), 84.5 (7.), 110.8 (4.)
Trefferlage: 0.01 mm links, 0.24 mm hoch
Streuwert: 1.37, horizontal: 1.04, vertikal: 1.63

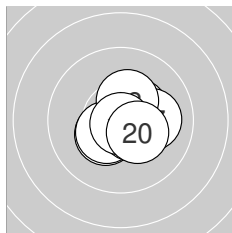

Serie 2: 104.5 (100)

10.4* ↗	10.4* ↘	10.6* ↘	10.4* ↘	10.5* ↘
10.5* →	10.1 →	10.4* ↑	10.8* ↓	10.4* ↘

beste Teiler: 26.1 (19.), 83.4 (13.), 109.9 (15.)
Trefferlage: 0.55 mm rechts, 0.16 mm tief
Streuwert: 0.92, horizontal: 1.01, vertikal: 0.81

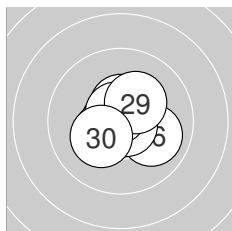

Serie 3: 105.1 (100)

10.9* ↘	10.6* ↗	10.7* ←	10.5* ↑	10.4* ↘
10.0 ↘	10.8* ↘	10.7* ↘	10.3* ↗	10.2* ↘

beste Teiler: 25.9 (21.), 50.8 (27.), 60.2 (23.)
Trefferlage: 0.10 mm rechts, 0.00 mm
Streuwert: 0.97, horizontal: 1.08, vertikal: 0.85

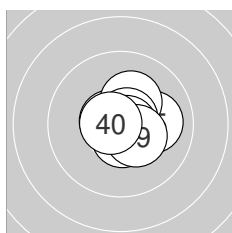

Serie 4: 105.2 (100)

10.6* ←	10.5* ↗	10.6* ↘	10.6* ↓	10.0 →
10.3* ↑	10.7* ↗	10.8* ↘	10.4* ↘	10.7* ←

beste Teiler: 45.6 (38.), 58.2 (37.), 71.3 (40.)
Trefferlage: 0.48 mm rechts, 0.06 mm hoch
Streuwert: 0.82, horizontal: 0.86, vertikal: 0.78



Ergebnis: **409.3** (392)
 Serien: 102.0 100.9 101.9 104.5
 Zähler: 32 8 0 0 0 0 0 0 0 0
 Innenzehner: 27
 Weitester: 484 (15.), 418 (7.), 372 (11.)
 beste Teiler: 54.7 (39.), 55.0 (14.), 63.7 (12.)
 Trefferlage: 0.31 mm links, 0.85 mm tief
 Streuwert: 1.36, horizontal: 1.27, vertikal: 1.44

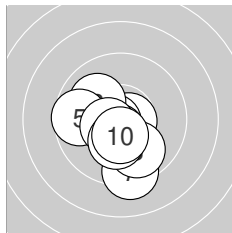
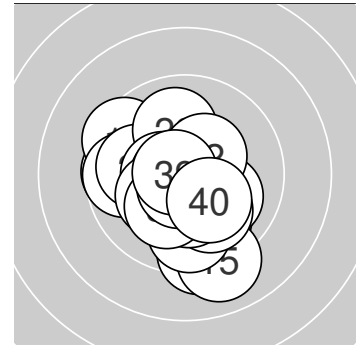

Serie 1: 102.0 (97)

10.7* →	10.7* ←	10.0 ↘	10.5* ↓	9.7 ←
10.5* ←	9.3 ↓	9.9 ↓	10.3* ↓	10.4* ↓

beste Teiler: 64.6 (2.), 65.7 (1.), 104.8 (4.)
 Trefferlage: 0.46 mm links, 0.99 mm tief
 Streuwert: 1.43, horizontal: 1.33, vertikal: 1.52

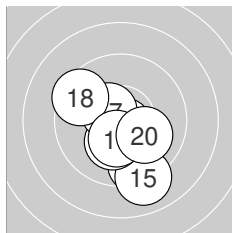

Serie 2: 100.9 (97)

9.5 ↓	10.7* ↓	10.3* ↓	10.7* ↓	9.0 ↓
10.2* ↓	10.5* ↘	9.5 ↘	10.4* ↓	10.1 ↘

beste Teiler: 55.0 (14.), 63.7 (12.), 118.4 (17.)
 Trefferlage: 0.04 mm rechts, 1.24 mm tief
 Streuwert: 1.67, horizontal: 1.49, vertikal: 1.83

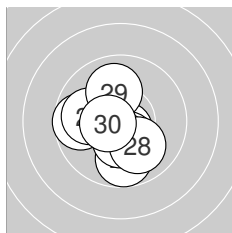

Serie 3: 101.9 (98)

10.5* ↘	9.8 ↓	10.7* ↓	10.3* ↓	10.4* ↓
9.7 ←	10.0 ←	10.0 ↓	10.0 ↑	10.5* ←

beste Teiler: 74.8 (23.), 102.5 (30.), 114.5 (21.)
 Trefferlage: 0.57 mm links, 0.53 mm tief
 Streuwert: 1.45, horizontal: 1.39, vertikal: 1.50

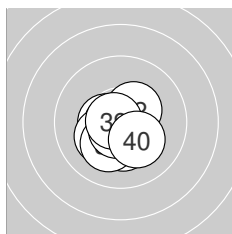

Serie 4: 104.5 (100)

10.5* ←	10.4* ↗	10.6* ↓	10.7* ←	10.3* ↓
10.2* ←	10.2* ↓	10.7* ↓	10.7* ←	10.2* ↓

beste Teiler: 54.7 (39.), 68.4 (34.), 69.3 (38.)
 Trefferlage: 0.27 mm links, 0.63 mm tief
 Streuwert: 0.88, horizontal: 0.89, vertikal: 0.86



Ergebnis: **417.0** (397)
 Serien: 104.0 104.3 104.5 104.2
 Zähler: 37 3 0 0 0 0 0 0 0 0 0
 Innenzehner: 34
 Weitester: 322 (31.), 285 (18.), 282 (12.)
 beste Teiler: 5.3 (37.), 32.3 (13.), 51.4 (3.)
 Trefferlage: 0.08 mm links, 0.11 mm tief
 Streuwert: 1.05, horizontal: 0.98, vertikal: 1.12

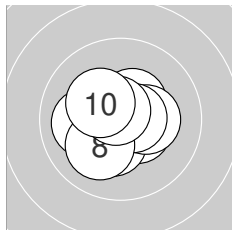
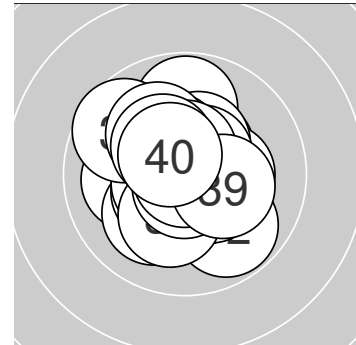

Serie 1: 104.0 (100)

10.5* ↘	10.4* ↗	10.7* →	10.3* ↓	10.3* →
10.6* →	10.1 ←	10.1 ↖	10.7* ↘	10.3* ↘

beste Teiler: 51.4 (3.), 63.5 (9.), 76.4 (6.)
 Trefferlage: 0.09 mm links, 0.12 mm tief
 Streuwert: 1.10, horizontal: 1.25, vertikal: 0.93

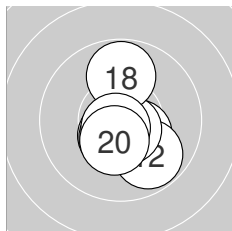

Serie 2: 104.3 (98)

10.4* ↘	9.8 ↘	10.8* ↓	10.7* ↓	10.5* ↓
10.7* ↘	10.5* ↓	9.8 ↑	10.7* ↓	10.4* ↓

beste Teiler: 32.3 (13.), 59.3 (19.), 59.4 (14.)
 Trefferlage: 0.17 mm rechts, 0.56 mm tief
 Streuwert: 1.07, horizontal: 0.75, vertikal: 1.31

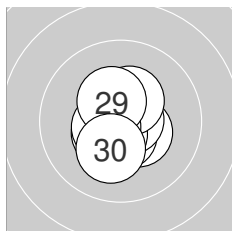

Serie 3: 104.5 (100)

10.4* ↘	10.2* ↓	10.6* ↓	10.5* ↖	10.7* →
10.6* ↓	10.4* ↗	10.5* ←	10.4* ↘	10.2* ↓

beste Teiler: 56.7 (25.), 88.8 (23.), 98.2 (26.)
 Trefferlage: 0.18 mm links, 0.43 mm tief
 Streuwert: 0.91, horizontal: 0.73, vertikal: 1.06

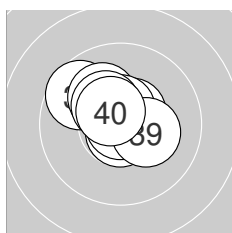

Serie 4: 104.2 (99)

9.7 ↘	10.6* ↗	10.1 ↘	10.5* ↗	10.7* ↓
10.6* ↑	10.9* ↓	10.3* ↘	10.3* →	10.5* ↘

beste Teiler: 5.3 (37.), 53.0 (35.), 90.2 (32.)
 Trefferlage: 0.23 mm links, 0.67 mm hoch
 Streuwert: 1.03, horizontal: 1.19, vertikal: 0.85



Ergebnis: **419.5** (399)
 Serien: 104.0 105.2 105.7 104.6
 Zähler: 39 1 0 0 0 0 0 0 0 0 0
 Innenzehner: 38
 Weitestе: 267 (17.), 241 (6.), 191 (2.)
 beste Teiler: 38.0 (13.), 44.5 (28.), 44.6 (25.)
 Trefferlage: 0.39 mm links, 0.23 mm hoch
 Streuwert: 0.86, horizontal: 0.85, vertikal: 0.86

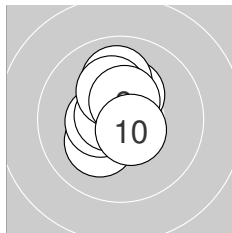
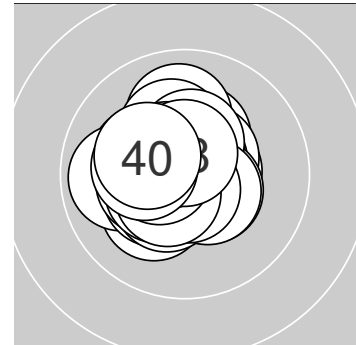

Serie 1: 104.0 (100)

10.4* ↑	10.2* ↙	10.4* ←	10.7* ↑	10.3* ↑
10.0 ↑	10.7* ↖	10.2* ↗	10.5* ↑	10.6* ↘

beste Teiler: 64.5 (4.), 72.7 (7.), 93.3 (10.)
 Trefferlage: 0.26 mm links, 0.68 mm hoch
 Streuwert: 0.97, horizontal: 0.69, vertikal: 1.18

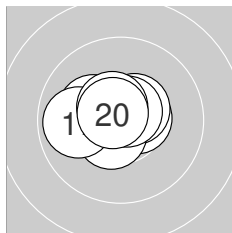

Serie 2: 105.2 (99)

10.7* ↗	10.6* →	10.8* ↘	10.2* ↖	10.5* ↗
10.5* ↙	9.9 ←	10.7* ↗	10.6* ↘	10.7* ↘

beste Teiler: 38.0 (13.), 56.3 (11.), 67.2 (20.)
 Trefferlage: 0.34 mm links, 0.28 mm hoch
 Streuwert: 0.89, horizontal: 1.16, vertikal: 0.49

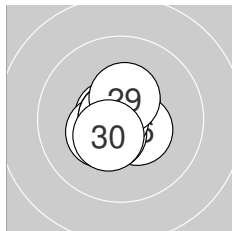

Serie 3: 105.7 (100)

10.7* ↑	10.7* ↖	10.5* ↑	10.4* ↙	10.8* ↖
10.5* ↘	10.5* ↙	10.8* ←	10.4* ↑	10.4* ↙

beste Teiler: 44.5 (28.), 44.6 (25.), 68.0 (22.)
 Trefferlage: 0.24 mm links, 0.00 mm
 Streuwert: 0.75, horizontal: 0.66, vertikal: 0.84

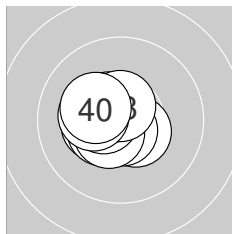

Serie 4: 104.6 (100)

10.5* ↘	10.7* ↓	10.3* ←	10.4* ↙	10.5* ↙
10.5* ←	10.5* ↘	10.6* ↑	10.3* ↖	10.3* ↖

beste Teiler: 65.6 (32.), 89.0 (38.), 107.6 (36.)
 Trefferlage: 0.74 mm links, 0.02 mm tief
 Streuwert: 0.78, horizontal: 0.86, vertikal: 0.69



LG 40 ZR

StandNr: 110

Knabl, Franz #70817480

Senioren_3fm

Wertung

StartNr: 58

05.03.2023 12:38

SG_Oetz

Ergebnis: **0.0** (0)_{DNS}
Serien:
Zähler: 0 0 0 0 0 0 0 0 0 0 0
Innenzehner: 0
Weiteste:
~~beste Teiler~~
Trefferlage: 0.00 mm , 0.00 mm
Streuwert:

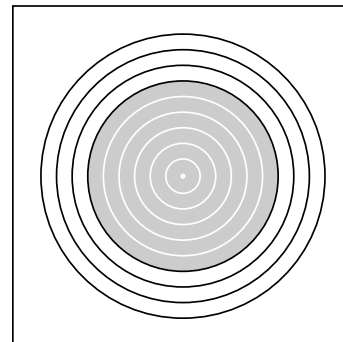

Ergebnis: 420.8 (399)
Serien: 105.2 105.4 106.0 104.2
Zähler: 39 1 0 0 0 0 0 0 0 0
Innenzehner: 38
Weiteste: 314 (34.), 205 (33.), 174 (40.)
beste Teiler: 12.8 (31.), 15.8 (26.), 16.1 (25.)
Trefferlage: 0.14 mm links, 0.07 mm hoch
Streuwert: 0.86, horizontal: 0.88, vertikal: 0.85

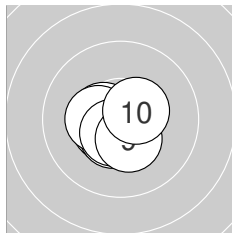
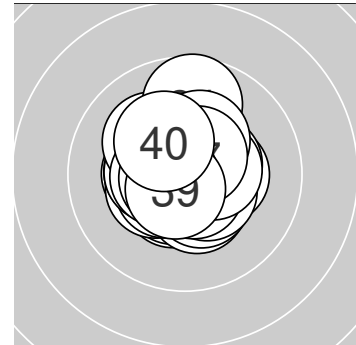

Serie 1: 105.2 (100)

10.8* ↘	10.5* ↙	10.6* ↘	10.5* ↙	10.5* ←
10.5* ↙	10.4* ←	10.5* ↘	10.4* ↘	10.5* ↘

beste Teiler: 38.2 (1.), 88.1 (3.), 103.4 (8.)
Trefferlage: 0.40 mm links, 0.46 mm tief
Streuwert: 0.71, horizontal: 0.81, vertikal: 0.60

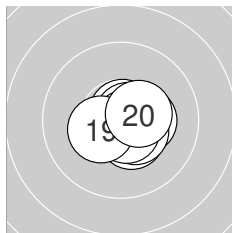

Serie 2: 105.4 (100)

10.7* ↑	10.3* →	10.7* ↗	10.8* ↘	10.6* →
10.4* ↘	10.5* ↘	10.6* ↘	10.4* ↙	10.4* ↗

beste Teiler: 42.1 (14.), 51.6 (11.), 57.8 (13.)
Trefferlage: 0.54 mm rechts, 0.22 mm tief
Streuwert: 0.67, horizontal: 0.78, vertikal: 0.53

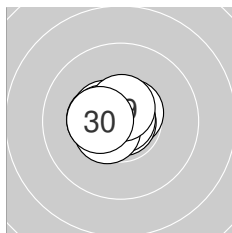

Serie 3: 106.0 (100)

10.7* ↘	10.6* ↗	10.4* ←	10.5* ↖	10.9* ↘
10.9* ↗	10.5* ←	10.5* ↙	10.6* ↑	10.4* ←

beste Teiler: 15.8 (26.), 16.1 (25.), 72.2 (21.)
Trefferlage: 0.54 mm links, 0.23 mm hoch
Streuwert: 0.60, horizontal: 0.73, vertikal: 0.42

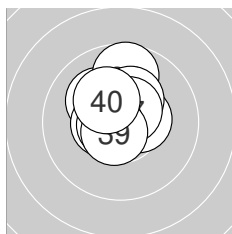

Serie 4: 104.2 (99)

10.9* ↗	10.5* →	10.1* ↘	9.7* ↑	10.3* ↗
10.5* ←	10.6* ↗	10.7* ←	10.6* ↘	10.3* ↘

beste Teiler: 12.8 (31.), 74.2 (38.), 78.7 (39.)
Trefferlage: 0.18 mm links, 0.76 mm hoch
Streuwert: 1.02, horizontal: 0.88, vertikal: 1.13



LG 40 ZR

Senioren_3fm

StartNr: 60

StandNr: 112

Wertung

05.03.2023 12:38

Daxenbichler, Michael #70418041

SG_Sportschützen_Scheffau

Ergebnis: **0.0** (0)_{DNS}
Serien:
Zähler: 0 0 0 0 0 0 0 0 0 0 0
Innenzehner: 0
Weiteste:
~~beste Teiler~~ Schütze ist nicht zum Wettkampf angetreten
Trefferlage: 0.00 mm , 0.00 mm
Streuwert:

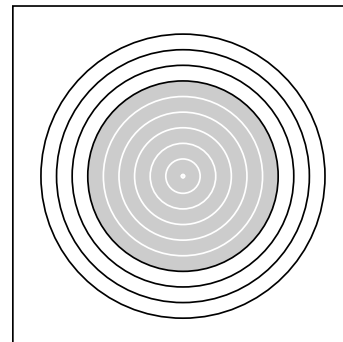

Ergebnis: **409.3** (389)
 Serien: 103.7 103.0 101.3 101.3
 Zähler: 29 11 0 0 0 0 0 0 0 0
 Innenzehner: 24
 Weitesten: 441 (30.), 361 (10.), 341 (37.)
 beste Teiler: 34.0 (19.), 37.8 (38.), 44.0 (8.)
 Trefferlage: 0.32 mm rechts, 0.03 mm hoch
 Streuwert: 1.46, horizontal: 1.53, vertikal: 1.38

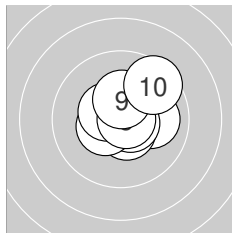
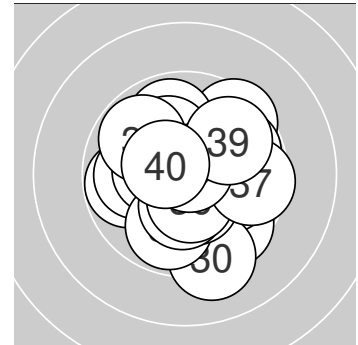

Serie 1: 103.7 (99)

10.0 →	10.6* ↘	10.6* →	10.4* ←	10.6* ↑
10.5* ↖	10.4* ↑	10.8* →	10.3* ↑	9.5 ↗

beste Teiler: 44.0 (8.), 81.3 (3.), 85.3 (5.)
 Trefferlage: 0.46 mm rechts, 0.51 mm hoch
 Streuwert: 1.14, horizontal: 1.20, vertikal: 1.08

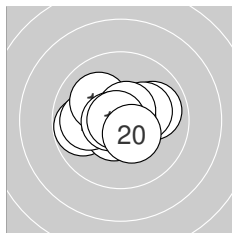

Serie 2: 103.0 (98)

9.8 ←	10.6* ↙	10.0 ←	9.9 →	10.1 ↘
10.2* →	10.6* ↗	10.6* ←	10.8* ←	10.4* ↘

beste Teiler: 34.0 (19.), 78.6 (18.), 85.2 (17.)
 Trefferlage: 0.31 mm links, 0.10 mm hoch
 Streuwert: 1.34, horizontal: 1.73, vertikal: 0.79

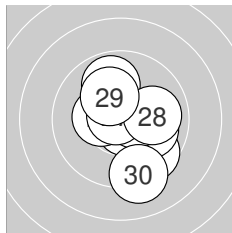

Serie 3: 101.3 (97)

9.6 ↘	9.9 ↑	10.7* ↘	10.0 →	10.5* →
10.4* ←	10.8* ↖	10.0 →	10.2* ↖	9.2 ↘

beste Teiler: 45.6 (27.), 67.4 (23.), 109.0 (25.)
 Trefferlage: 0.63 mm rechts, 0.29 mm tief
 Streuwert: 1.72, horizontal: 1.44, vertikal: 1.95

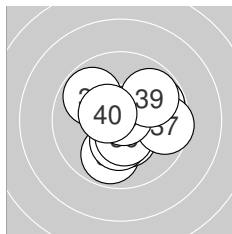

Serie 4: 101.3 (95)

9.9 ↙	10.4* ↘	10.3* ↓	9.8 ↖	9.8 →
10.4* ↓	9.6 →	10.8* ↗	9.8 ↗	10.5* ↖

beste Teiler: 37.8 (38.), 111.8 (40.), 129.0 (36.)
 Trefferlage: 0.52 mm rechts, 0.18 mm tief
 Streuwert: 1.64, horizontal: 1.75, vertikal: 1.51



Ergebnis: 416.6 (398)
Serien: 104.0 104.2 104.3 104.1
Zähler: 38 2 0 0 0 0 0 0 0 0
Innenzehner: 33
Weiteste: 276 (17.), 269 (28.), 227 (3.)
beste Teiler: 25.6 (25.), 27.0 (35.), 50.3 (22.)
Trefferlage: 0.08 mm links, 0.11 mm tief
Streuwert: 1.06, horizontal: 1.23, vertikal: 0.85

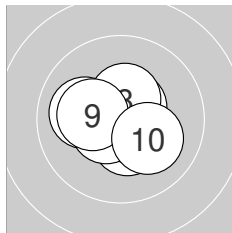
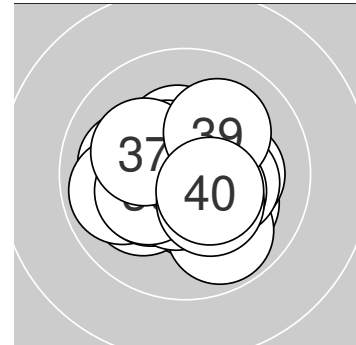

Serie 1: 104.0 (100)

10.6* ↗	10.6* ↑	10.0 ←	10.4* ↓	10.6* ↘
10.5* ↙	10.6* ↗	10.4* ↑	10.2* ←	10.1 ↘

beste Teiler: 81.1 (2.), 82.4 (5.), 84.5 (1.)
Trefferlage: 0.07 mm links, 0.07 mm hoch
Streuwert: 1.06, horizontal: 1.20, vertikal: 0.90

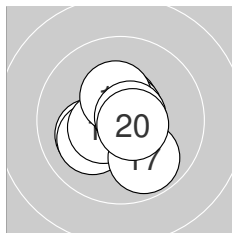

Serie 2: 104.2 (99)

10.7* ↘	10.1 ↙	10.6* ↑	10.1 ↙	10.5* ↙
10.7* ↗	9.8 ↘	10.4* ↑	10.7* →	10.6* ↘

beste Teiler: 64.5 (19.), 70.6 (11.), 72.7 (16.)
Trefferlage: 0.11 mm links, 0.22 mm tief
Streuwert: 1.12, horizontal: 1.12, vertikal: 1.12

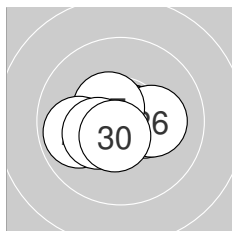

Serie 3: 104.3 (99)

10.4* ←	10.8* →	10.4* →	10.3* ←	10.9* ↘
10.2* →	10.5* ↘	9.9 ←	10.3* ←	10.6* ↓

beste Teiler: 25.6 (25.), 50.3 (22.), 99.7 (30.)
Trefferlage: 0.40 mm links, 0.23 mm tief
Streuwert: 1.08, horizontal: 1.43, vertikal: 0.52

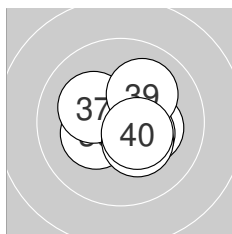

Serie 4: 104.1 (100)

10.7* →	10.3* →	10.5* ←	10.4* ↘	10.8* ↑
10.3* ↙	10.2* ↘	10.3* ↘	10.1 ↗	10.5* ↘

beste Teiler: 27.0 (35.), 61.5 (31.), 109.4 (33.)
Trefferlage: 0.26 mm rechts, 0.05 mm tief
Streuwert: 1.09, horizontal: 1.26, vertikal: 0.88



Ergebnis: 416.3 (395)
Serien: 105.1 102.7 104.1 104.4
Zähler: 35 5 0 0 0 0 0 0 0 0 0
Innenzehner: 29
Weiteste: 319 (20.), 314 (19.), 266 (11.)
beste Teiler: 9.2 (13.), 13.9 (17.), 31.5 (36.)
Trefferlage: 0.37 mm links, 0.13 mm hoch
Streuwert: 1.12, horizontal: 1.25, vertikal: 0.96

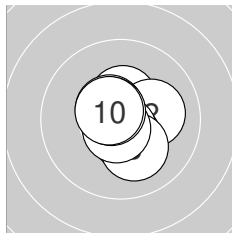
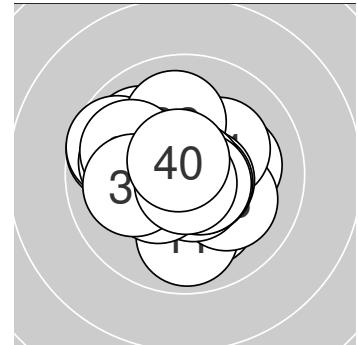

Serie 1: 105.1 (100)

10.4* ↑	10.1 →	10.8* ↗	10.5* ↓	10.7* ↓
10.1 ↓	10.7* ↓	10.6* ↘	10.6* ↘	10.6* ↘

beste Teiler: 43.2 (3.), 67.6 (7.), 75.3 (5.)
Trefferlage: 0.08 mm rechts, 0.11 mm tief
Streuwert: 0.91, horizontal: 0.86, vertikal: 0.96

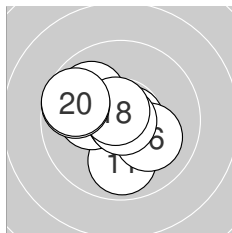

Serie 2: 102.7 (96)

9.9 ↓	10.2* ←	10.9* ↑	10.7* →	9.9 ↖
10.1 ↘	10.9* ↘	10.7* ↘	9.7 ↖	9.7 ↖

beste Teiler: 9.2 (13.), 13.9 (17.), 59.0 (14.)
Trefferlage: 0.74 mm links, 0.10 mm hoch
Streuwert: 1.43, horizontal: 1.60, vertikal: 1.24

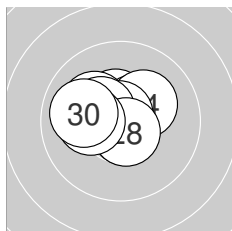

Serie 3: 104.1 (100)

10.5* ↑	10.5* ↗	10.7* ↓	10.2* ↗	10.2* ↖
10.8* ↑	10.4* ↖	10.6* ↓	10.2* ←	10.0 ←

beste Teiler: 42.4 (26.), 74.2 (23.), 79.6 (28.)
Trefferlage: 0.47 mm links, 0.44 mm hoch
Streuwert: 1.05, horizontal: 1.31, vertikal: 0.69

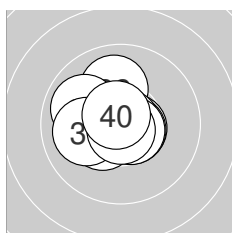

Serie 4: 104.4 (99)

10.6* ↘	10.0 ↑	10.4* ↗	10.6* ↘	9.9 ↖
10.8* →	10.0 ←	10.6* ↘	10.8* ↓	10.7* ↖

beste Teiler: 31.5 (36.), 39.1 (39.), 66.6 (40.)
Trefferlage: 0.39 mm links, 0.12 mm hoch
Streuwert: 1.06, horizontal: 1.17, vertikal: 0.94



Ergebnis: 416.4 (398)
Serien: 103.5 104.1 105.0 103.8
Zähler: 38 2 0 0 0 0 0 0 0 0
Innenzehner: 35
Weiteste: 405 (12.), 260 (20.), 239 (1.)
beste Teiler: 22.3 (13.), 35.3 (11.), 36.1 (10.)
Trefferlage: 0.54 mm rechts, 0.11 mm hoch
Streuwert: 1.04, horizontal: 1.05, vertikal: 1.02

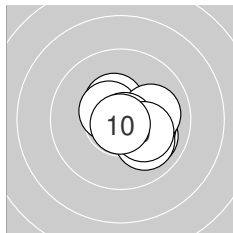
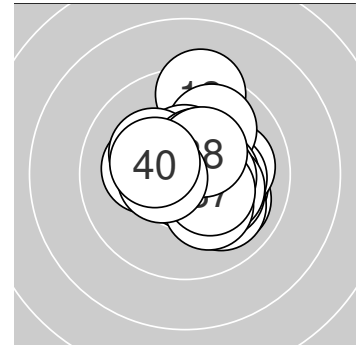

Serie 1: 103.5 (100)

10.0 ↘	10.6* →	10.4* ↖	10.2* →	10.5* ↖
10.0 ↘	10.0 →	10.8* ↘	10.2* →	10.8* ↓

beste Teiler: 36.1 (10.), 38.2 (8.), 82.0 (2.)
Trefferlage: 0.94 mm rechts, 0.27 mm tief
Streuwert: 1.01, horizontal: 1.15, vertikal: 0.85

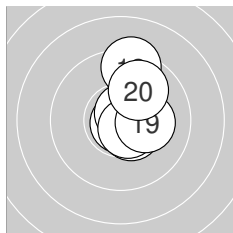

Serie 2: 104.1 (98)

10.8* ↘	9.3 ↑	10.9* ↓	10.6* →	10.5* ↘
10.6* ↗	10.7* ↗	10.6* ↘	10.2* →	9.9 ↗

beste Teiler: 22.3 (13.), 35.3 (11.), 60.4 (17.)
Trefferlage: 0.73 mm rechts, 0.51 mm hoch
Streuwert: 1.11, horizontal: 0.54, vertikal: 1.48

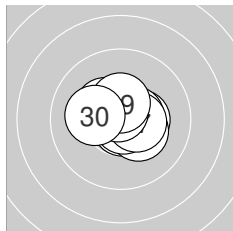

Serie 3: 105.0 (100)

10.7* ↓	10.4* →	10.3* ↘	10.5* →	10.4* ↖
10.8* ↘	10.5* →	10.7* ↖	10.5* ↑	10.2* ←

beste Teiler: 42.7 (26.), 52.3 (21.), 57.8 (28.)
Trefferlage: 0.20 mm rechts, 0.10 mm hoch
Streuwert: 0.91, horizontal: 1.11, vertikal: 0.64

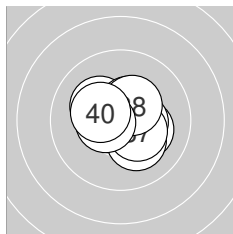

Serie 4: 103.8 (100)

10.7* ↑	10.2* ↘	10.2* ↘	10.2* ↖	10.5* ↗
10.4* →	10.4* ↘	10.4* ↗	10.5* ←	10.3* ↖

beste Teiler: 63.3 (31.), 113.4 (39.), 117.7 (35.)
Trefferlage: 0.28 mm rechts, 0.09 mm hoch
Streuwert: 1.09, horizontal: 1.24, vertikal: 0.91



Ergebnis: 398.1 (380)
Serien: 97.6 100.2 101.0 99.3
Zähler: 23 15 1 1 0 0 0 0 0 0 0
Innenzehner: 16
Weiteste: 753 (37.), 688 (8.), 494 (2.)
beste Teiler: 43.1 (11.), 49.2 (39.), 53.8 (1.)
Trefferlage: 0.78 mm links, 0.23 mm tief
Streuwert: 2.01, horizontal: 2.42, vertikal: 1.51

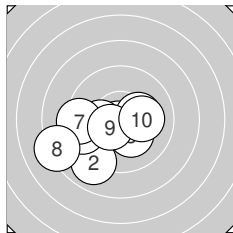
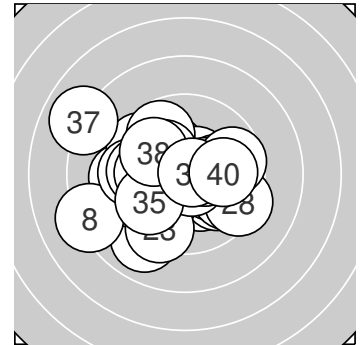

Serie 1: 97.6 (95)

10.7* ↙	9.0 ↙	10.2* ↘	10.1 ←	9.4 ←
10.2* →	9.3 ←	8.2 ←	10.4* ↗	10.1 →

beste Teiler: 53.8 (1.), 128.2 (9.), 178.5 (6.)
Trefferlage: 1.51 mm links, 1.10 mm tief
Streuwert: 2.18, horizontal: 2.73, vertikal: 1.42

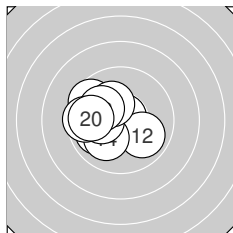

Serie 2: 100.2 (95)

10.8* ↗	9.9 ↘	9.9 ←	10.1 ↙	9.6 ↘
10.2* ←	10.2* ↖	10.1 ↖	9.6 ←	9.8 ←

beste Teiler: 43.1 (11.), 181.2 (17.), 187.1 (16.)
Trefferlage: 1.51 mm links, 0.07 mm hoch
Streuwert: 1.47, horizontal: 1.68, vertikal: 1.23

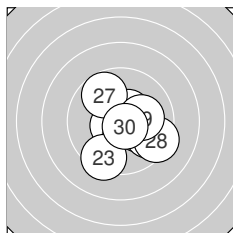

Serie 3: 101.0 (96)

10.7* ↓	10.6* ↖	9.4 ↙	10.2* ↘	9.7 ↘
10.5* ↗	9.7 ↘	9.4 ↘	10.1 →	10.7* ↘

beste Teiler: 56.0 (21.), 67.3 (30.), 87.7 (22.)
Trefferlage: 0.72 mm rechts, 0.52 mm tief
Streuwert: 1.71, horizontal: 1.78, vertikal: 1.63

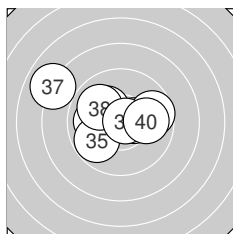

Serie 4: 99.3 (94)

10.6* ←	10.4* →	10.2* ↘	10.0 ←	9.8 ↖
9.7 →	7.9 ↖	10.0 ↘	10.8* →	9.9 →

beste Teiler: 49.2 (39.), 79.6 (31.), 133.8 (32.)
Trefferlage: 0.81 mm links, 0.60 mm hoch
Streuwert: 2.23, horizontal: 2.86, vertikal: 1.35



Ergebnis: **422.0** (400)
 Serien: 105.4 106.2 105.6 104.8
 Zähler: 40 0 0 0 0 0 0 0 0 0
 Innenzehner: 39
 Weitestе: 208 (3.), 182 (33.), 175 (36.)
 beste Teiler: 9.2 (20.), 14.8 (6.), 25.0 (16.)
 Trefferlage: 0.16 mm rechts, 0.21 mm hoch
 Streuwert: 0.77, horizontal: 0.72, vertikal: 0.81

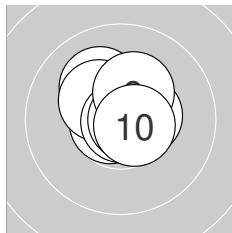
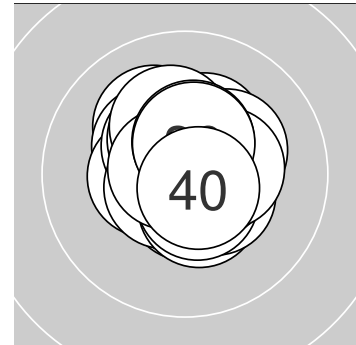

Serie 1: 105.4 (100)

10.5* ↗	10.7* ↖	10.1 ↘	10.5* →	10.3* ↖
10.9* ↓	10.7* →	10.8* →	10.3* ↗	10.6* ↘

beste Teiler: 14.8 (6.), 44.1 (8.), 60.4 (2.)
 Trefferlage: 0.13 mm rechts, 0.47 mm hoch
 Streuwert: 0.80, horizontal: 0.82, vertikal: 0.77

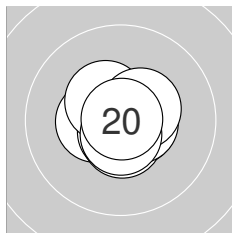

Serie 2: 106.2 (100)

10.4* ←	10.7* ↓	10.6* →	10.4* ↘	10.6* ↓
10.9* →	10.6* →	10.5* ↗	10.6* ↓	10.9* ↗

beste Teiler: 9.2 (20.), 25.0 (16.), 65.3 (12.)
 Trefferlage: 0.09 mm rechts, 0.11 mm tief
 Streuwert: 0.69, horizontal: 0.76, vertikal: 0.61

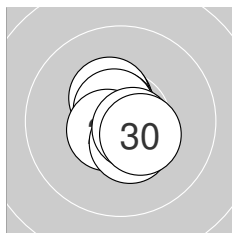

Serie 3: 105.6 (100)

10.5* ↘	10.4* ↘	10.8* ↘	10.7* ↘	10.7* ↘
10.5* ↓	10.6* ↗	10.4* ↓	10.6* →	10.4* ↘

beste Teiler: 38.2 (23.), 60.4 (24.), 72.5 (25.)
 Trefferlage: 0.01 mm rechts, 0.00 mm
 Streuwert: 0.77, horizontal: 0.63, vertikal: 0.89

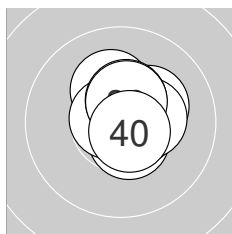

Serie 4: 104.8 (100)

10.4* ↑	10.5* ↓	10.2* ↑	10.6* →	10.7* ↖
10.3* ↗	10.4* →	10.5* ↑	10.5* ↑	10.7* ↘

beste Teiler: 62.6 (35.), 70.7 (40.), 89.1 (34.)
 Trefferlage: 0.42 mm rechts, 0.52 mm hoch
 Streuwert: 0.80, horizontal: 0.71, vertikal: 0.88



Ergebnis: 412.1 (394)
Serien: 102.7 102.9 102.5 104.0
Zähler: 34 6 0 0 0 0 0 0 0 0 0
Innenzehner: 28
Weiteste: 376 (17.), 324 (22.), 292 (3.)
beste Teiler: 1.0 (29.), 23.0 (14.), 30.8 (39.)
Trefferlage: 0.25 mm links, 0.15 mm tief
Streuwert: 1.29, horizontal: 1.43, vertikal: 1.13

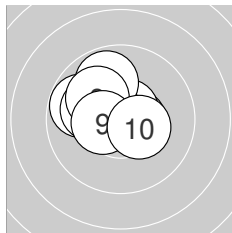
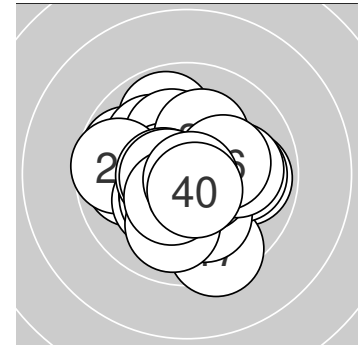

Serie 1: 102.7 (98)

10.2* ↖	10.6* →	9.8 ↖	10.7* ↗	10.1 ↖
10.6* ↖	9.8 ↗	10.1 ↖	10.4* ←	10.4* →

beste Teiler: 74.4 (4.), 89.3 (6.), 99.7 (2.)
Trefferlage: 0.83 mm links, 0.69 mm hoch
Streuwert: 1.15, horizontal: 1.34, vertikal: 0.91

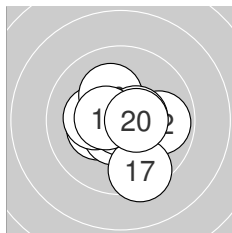

Serie 2: 102.9 (98)

10.3* ←	9.9 →	10.5* ↘	10.9* ↓	10.2* ←
10.2* ↗	9.4 ↘	10.5* →	10.5* ←	10.5* →

beste Teiler: 23.0 (14.), 101.5 (13.), 104.2 (19.)
Trefferlage: 0.07 mm rechts, 0.31 mm tief
Streuwert: 1.39, horizontal: 1.46, vertikal: 1.32

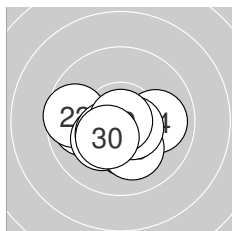

Serie 3: 102.5 (98)

9.9 ←	9.7 ←	10.3* ↓	10.0 →	10.2* ↗
10.1 ↓	10.6* ↘	10.4* ↗	10.9* →	10.4* ↗

beste Teiler: 1.0 (29.), 91.9 (27.), 129.5 (28.)
Trefferlage: 0.45 mm links, 0.71 mm tief
Streuwert: 1.31, horizontal: 1.70, vertikal: 0.76

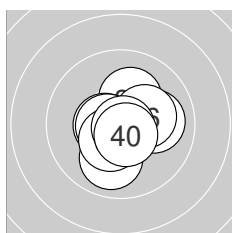

Serie 4: 104.0 (100)

10.0 →	10.7* ↓	10.2* ↗	10.0 ↓	10.5* ←
10.2* →	10.6* ←	10.4* ↗	10.8* ↘	10.6* ↘

beste Teiler: 30.8 (39.), 65.7 (32.), 83.6 (40.)
Trefferlage: 0.19 mm rechts, 0.28 mm tief
Streuwert: 1.11, horizontal: 1.14, vertikal: 1.08

