

**LG 40 ZR**

StandNr: 138

**Emberger, Karin** #70817453

**Frauen**

Wertung

**StartNr: 86**

05.03.2023 12:39

SG\_Mayrhofen

Ergebnis: **0.0** (0)<sub>DNS</sub>  
Serien:  
Zähler: 0 0 0 0 0 0 0 0 0 0 0  
Innenzehner: 0  
Weiteste:  
~~beste Teiler~~Schütze ist nicht zum Wettkampf angetreten  
Trefferlage: 0.00 mm , 0.00 mm  
Streuwert:

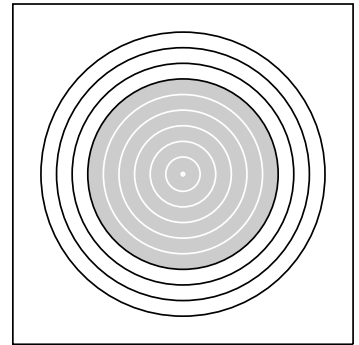

**Ergebnis: 416.6 (398)**  
**Serien:** 104.1 104.0 104.4 104.1  
**Zähler:** 38 2 0 0 0 0 0 0 0 0  
**Innenzehner:** 34  
**Weiteste:** 332 (17.), 331 (19.), 235 (8.)  
**beste Teiler:** 30.2 (14.), 44.5 (18.), 45.1 (33.)  
**Trefferlage:** 0.47 mm links, 0.17 mm tief  
**Streuwert:** 1.02, horizontal: 1.00, vertikal: 1.05

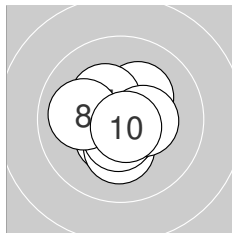
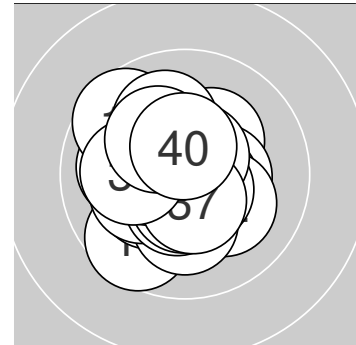

**Serie 1: 104.1 (100)**

10.2* ↗	10.4* ↘	10.2* ↓	10.7* ↙	10.7* ↘
10.5* ↓	10.3* ↖	10.0 ←	10.4* →	10.7* ↘

**beste Teiler:** 58.8 (10.), 68.0 (5.), 69.4 (4.)  
**Trefferlage:** 0.15 mm links, 0.26 mm tief  
**Streuwert:** 1.05, horizontal: 1.07, vertikal: 1.02

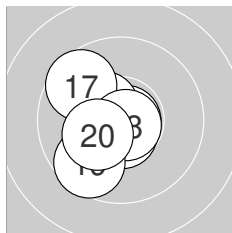

**Serie 2: 104.0 (98)**

10.7* ↘	10.5* ←	10.7* ←	10.8* →	10.6* ↓
10.4* ↖	9.6 ↖	10.8* ↘	9.6 ↗	10.3* ↗

**beste Teiler:** 30.2 (14.), 44.5 (18.), 55.0 (13.)  
**Trefferlage:** 0.81 mm links, 0.19 mm tief  
**Streuwert:** 1.12, horizontal: 0.96, vertikal: 1.26

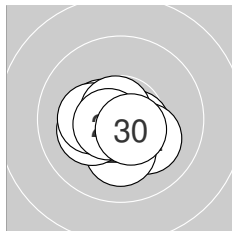

**Serie 3: 104.4 (100)**

10.6* ↘	10.1 ↘	10.2* ↓	10.6* ←	10.2* ←
10.5* ←	10.3* ←	10.7* ↖	10.6* ←	10.6* ↘

**beste Teiler:** 57.6 (28.), 82.4 (29.), 91.9 (30.)  
**Trefferlage:** 0.35 mm links, 0.45 mm tief  
**Streuwert:** 0.95, horizontal: 1.13, vertikal: 0.73

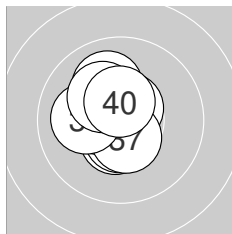

**Serie 4: 104.1 (100)**

10.0 ↖	10.5* ↓	10.8* ←	10.5* ↓	10.4* ←
10.6* ↗	10.5* ↓	10.1 ←	10.2* ↖	10.5* ↑

**beste Teiler:** 45.1 (33.), 87.9 (36.), 107.2 (34.)  
**Trefferlage:** 0.57 mm links, 0.23 mm hoch  
**Streuwert:** 1.00, horizontal: 0.83, vertikal: 1.14



**Ergebnis: 417.6 (397)**  
**Serien: 103.7 104.9 104.5 104.5**  
**Zähler: 37 3 0 0 0 0 0 0 0 0 0**  
**Innenzehner: 32**  
**Weiteste: 295 (7.), 291 (38.), 277 (8.)**  
**beste Teiler: 21.5 (35.), 40.4 (14.), 42.0 (11.)**  
**Trefferlage: 0.19 mm links, 0.21 mm hoch**  
**Streuwert: 1.04, horizontal: 1.10, vertikal: 0.98**

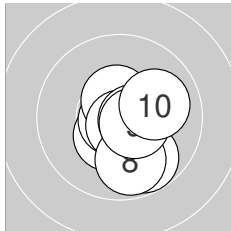
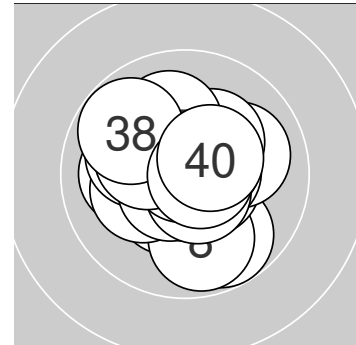

**Serie 1: 103.7 (98)**

10.4* ↙	10.8* ↙	10.6* ↘	10.5* ↑	10.7* ↓
10.6* →	9.8 ↓	9.8 ↓	10.5* →	10.0 →

**beste Teiler: 42.4 (2.), 51.9 (5.), 89.6 (6.)**  
**Trefferlage: 0.59 mm rechts, 0.62 mm tief**  
**Streuwert: 1.08, horizontal: 0.89, vertikal: 1.23**

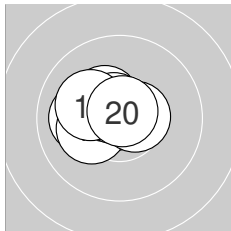

**Serie 2: 104.9 (100)**

10.8* ↖	10.4* ←	10.1 ←	10.8* ↖	10.4* ↖
10.2* ←	10.7* ↖	10.1 ↖	10.6* →	10.8* ↗

**beste Teiler: 40.4 (14.), 42.0 (11.), 47.5 (20.)**  
**Trefferlage: 0.80 mm links, 0.28 mm hoch**  
**Streuwert: 0.81, horizontal: 1.03, vertikal: 0.50**

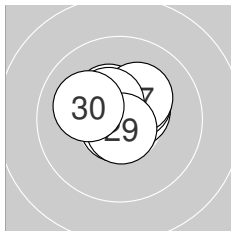

**Serie 3: 104.5 (100)**

10.5* ↗	10.4* ↗	10.6* ↖	10.3* ↖	10.8* ↙
10.4* ↖	10.2* ↗	10.5* ↖	10.7* ↓	10.1 ↖

**beste Teiler: 50.6 (25.), 60.0 (29.), 92.1 (23.)**  
**Trefferlage: 0.22 mm links, 0.65 mm hoch**  
**Streuwert: 0.88, horizontal: 1.05, vertikal: 0.66**

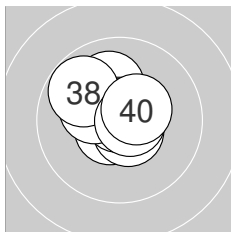

**Serie 4: 104.5 (99)**

10.4* ↖	10.7* ↗	10.6* ↙	10.6* ↓	10.9* ↖
10.3* ↖	10.1 ↑	9.8 ↖	10.7* →	10.4* ↗

**beste Teiler: 21.5 (35.), 55.1 (32.), 66.1 (39.)**  
**Trefferlage: 0.32 mm links, 0.54 mm hoch**  
**Streuwert: 1.00, horizontal: 1.07, vertikal: 0.93**



Ergebnis: **409.8** (393)  
 Serien: 102.2 102.8 102.6 102.2  
 Zähler: 33 7 0 0 0 0 0 0 0 0  
 Innenzehner: 30  
 Weitester: 394 (37.), 360 (4.), 355 (16.)  
 beste Teiler: 41.1 (8.), 58.6 (20.), 68.1 (14.)  
 Trefferlage: 0.58 mm links, 0.41 mm tief  
 Streuwert: 1.29, horizontal: 1.26, vertikal: 1.31

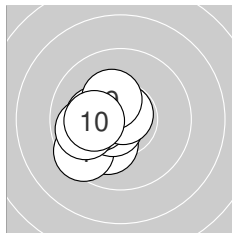
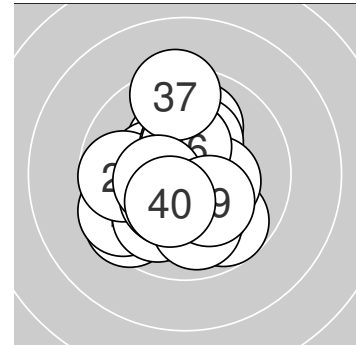

**Serie 1: 102.2 (98)**

10.3* ↙	10.1 ↘	10.2* ←	9.5 ↙	10.6* ↙
10.3* ←	9.9 ↙	10.8* ↗	10.3* ↘	10.2* ←

beste Teiler: 41.1 (8.), 77.8 (5.), 154.3 (1.)  
 Trefferlage: 1.39 mm links, 0.47 mm tief  
 Streuwert: 1.02, horizontal: 0.93, vertikal: 1.10

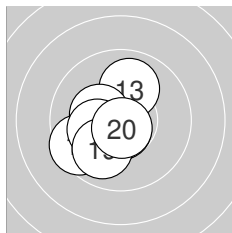

**Serie 2: 102.8 (99)**

10.5* ←	10.6* ↓	10.0 ↑	10.7* ↓	10.3* ↙
9.5 ↙	10.3* ←	10.2* ←	10.0 ↙	10.7* ↓

beste Teiler: 58.6 (20.), 68.1 (14.), 80.2 (12.)  
 Trefferlage: 0.97 mm links, 0.44 mm tief  
 Streuwert: 1.17, horizontal: 1.11, vertikal: 1.23

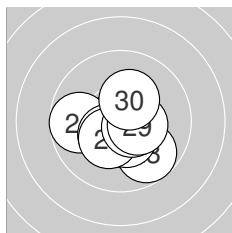

**Serie 3: 102.6 (98)**

10.4* ←	10.3* ↘	9.8 ↘	9.7 ←	10.4* ↙
10.4* ↓	10.3* ↙	10.6* ↘	10.4* →	10.3* ↗

beste Teiler: 93.4 (28.), 126.8 (26.), 128.8 (29.)  
 Trefferlage: 0.03 mm links, 0.68 mm tief  
 Streuwert: 1.28, horizontal: 1.48, vertikal: 1.03

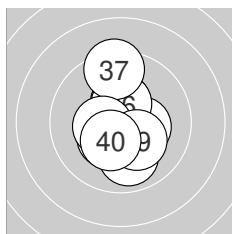

**Serie 4: 102.2 (98)**

9.9 ↓	10.3* ↙	10.6* →	10.3* →	10.4* ↑
10.4* ↑	9.4 ↑	10.4* ←	10.2* ↘	10.3* ↙

beste Teiler: 87.3 (33.), 135.8 (38.), 136.1 (36.)  
 Trefferlage: 0.06 mm rechts, 0.05 mm tief  
 Streuwert: 1.47, horizontal: 0.96, vertikal: 1.84



**Ergebnis: 412.6 (396)**  
**Serien: 102.9 103.3 102.8 103.6**  
**Zähler: 36 4 0 0 0 0 0 0 0 0 0**  
**Innenzehner: 29**  
**Weiteste: 322 (16.), 320 (25.), 277 (4.)**  
**beste Teiler: 14.1 (8.), 19.0 (17.), 52.4 (22.)**  
**Trefferlage: 0.03 mm rechts, 0.38 mm hoch**  
**Streuwert: 1.22, horizontal: 1.42, vertikal: 0.99**

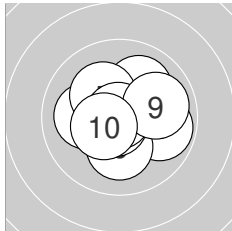
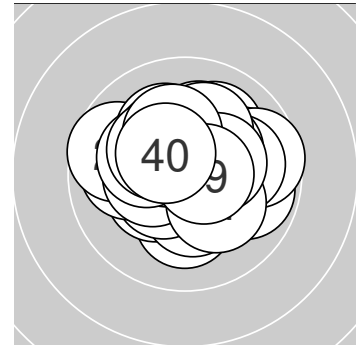

**Serie 1: 102.9 (98)**

10.6* →	10.1 ←	10.0 ↗	9.8 →	10.2* ↖
10.2* ↓	10.7* ↗	10.9* ↖	9.9 →	10.5* ↖

**beste Teiler: 14.1 (8.), 53.1 (7.), 88.2 (1.)**  
**Trefferlage: 0.24 mm rechts, 0.07 mm hoch**  
**Streuwert: 1.37, horizontal: 1.57, vertikal: 1.12**

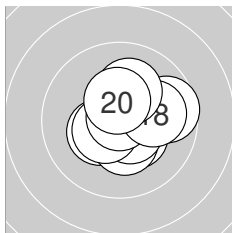

**Serie 2: 103.3 (99)**

10.4* ↘	10.3* ↖	10.4* ↓	10.6* ↘	10.5* ↖
9.7 →	10.9* ↑	10.0 →	10.1 ↑	10.4* ↑

**beste Teiler: 19.0 (17.), 99.0 (14.), 116.4 (15.)**  
**Trefferlage: 0.56 mm rechts, 0.00 mm**  
**Streuwert: 1.23, horizontal: 1.35, vertikal: 1.10**

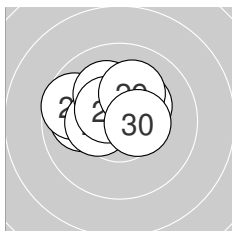

**Serie 3: 102.8 (99)**

10.5* ↗	10.7* ↗	10.3* ↗	10.0 ←	9.7 ←
10.4* ←	10.1 ↖	10.5* ↖	10.1 ↑	10.5* →

**beste Teiler: 52.4 (22.), 111.0 (28.), 121.5 (30.)**  
**Trefferlage: 0.38 mm links, 0.74 mm hoch**  
**Streuwert: 1.22, horizontal: 1.58, vertikal: 0.71**

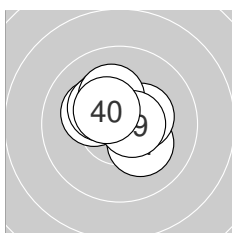

**Serie 4: 103.6 (100)**

10.2* ↘	10.3* →	10.6* ↖	10.5* ↖	10.3* ↖
10.2* ↖	10.3* ↖	10.2* ↑	10.6* →	10.4* ↖

**beste Teiler: 85.0 (39.), 93.9 (33.), 115.1 (34.)**  
**Trefferlage: 0.27 mm links, 0.70 mm hoch**  
**Streuwert: 0.99, horizontal: 1.11, vertikal: 0.85**



**Ergebnis: 407.0 (390)**  
**Serien: 99.6 104.1 102.6 100.7**  
**Zähler: 31 8 1 0 0 0 0 0 0 0**  
**Innenzehner: 22**  
**Weiteste: 662 (4.), 344 (24.), 339 (21.)**  
**beste Teiler: 17.4 (11.), 19.1 (26.), 37.6 (14.)**  
**Trefferlage: 0.02 mm links, 0.07 mm tief**  
**Streuwert: 1.62, horizontal: 2.04, vertikal: 1.06**

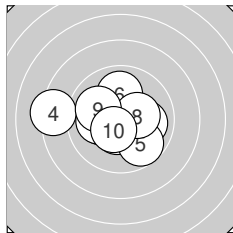
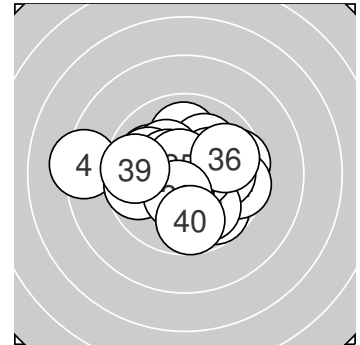

**Serie 1: 99.6 (97)**

10.2* ←	10.0 →	10.5* ↓	8.3 ←	9.7 ↘
10.0 ↑	10.1 ←	10.3* →	10.0 ↖	10.5* ↙

**beste Teiler: 121.7 (10.), 125.0 (3.), 166.1 (8.)**  
**Trefferlage: 0.79 mm links, 0.09 mm tief**  
**Streuwert: 2.08, horizontal: 2.63, vertikal: 1.32**

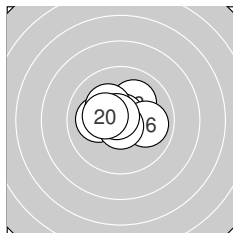

**Serie 2: 104.1 (100)**

10.9* ↗	10.3* →	10.1 ↗	10.8* ↑	10.1 ←
10.0 →	10.7* ↓	10.2* ↘	10.7* ↘	10.3* ←

**beste Teiler: 17.4 (11.), 37.6 (14.), 53.1 (19.)**  
**Trefferlage: 0.03 mm rechts, 0.33 mm hoch**  
**Streuwert: 1.14, horizontal: 1.45, vertikal: 0.70**

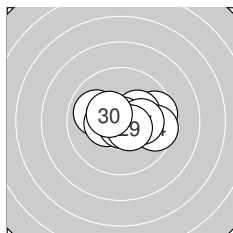

**Serie 3: 102.6 (98)**

9.6 →	10.0 ↖	10.2* ↗	9.6 →	10.4* ←
10.9* ↗	10.2* →	10.8* ↓	10.5* ↘	10.4* ↘

**beste Teiler: 19.1 (26.), 42.9 (28.), 107.2 (29.)**  
**Trefferlage: 0.66 mm rechts, 0.10 mm hoch**  
**Streuwert: 1.44, horizontal: 1.95, vertikal: 0.60**

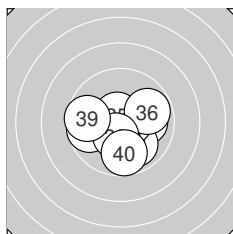

**Serie 4: 100.7 (95)**

10.0 →	9.9 ↘	10.6* →	10.4* ↓	10.6* ↘
9.8 ↗	9.7 ←	10.4* ↓	9.6 ←	9.7 ↓

**beste Teiler: 76.9 (35.), 90.1 (33.), 143.2 (38.)**  
**Trefferlage: 0.01 mm rechts, 0.64 mm tief**  
**Streuwert: 1.68, horizontal: 1.99, vertikal: 1.31**



**Ergebnis: 413.3 (396)**  
**Serien: 103.6 104.3 101.6 103.8**  
**Zähler: 36 4 0 0 0 0 0 0 0 0**  
**Innenzehner: 26**  
**Weiteste: 383 (23.), 309 (32.), 255 (4.)**  
**beste Teiler: 17.2 (39.), 39.8 (34.), 57.2 (11.)**  
**Trefferlage: 0.21 mm links, 0.19 mm tief**  
**Streuwert: 1.22, horizontal: 1.34, vertikal: 1.09**

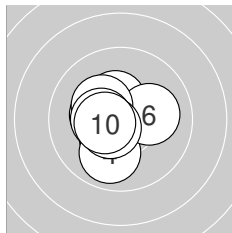
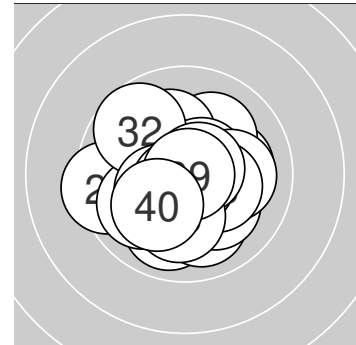

**Serie 1: 103.6 (99)**

10.7* ↘	10.4* ↑	10.4* ↗	9.9 ↓	10.3* ←
10.1 →	10.3* ↘	10.6* ↗	10.4* ←	10.5* ←

**beste Teiler: 67.6 (1.), 96.5 (8.), 118.1 (10.)**  
**Trefferlage: 0.64 mm links, 0.09 mm tief**  
**Streuwert: 1.07, horizontal: 1.04, vertikal: 1.10**

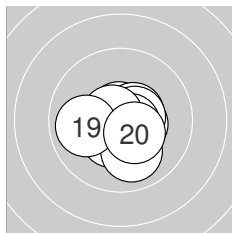

**Serie 2: 104.3 (99)**

10.7* ↑	10.5* ↗	10.5* →	10.5* →	10.7* ↘
10.4* ↘	10.0 ↓	10.7* ↘	9.9 ←	10.4* ↘

**beste Teiler: 57.2 (11.), 68.8 (18.), 70.2 (15.)**  
**Trefferlage: 0.17 mm rechts, 0.37 mm tief**  
**Streuwert: 1.04, horizontal: 1.17, vertikal: 0.88**

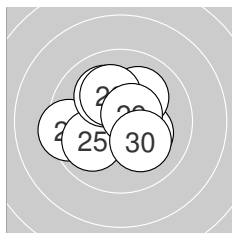

**Serie 3: 101.6 (99)**

10.4* ←	10.2* ↘	9.4 ←	10.6* ↘	10.0 ↗
10.1 ↗	10.1 ↘	10.1 ↘	10.6* ↗	10.1 ↘

**beste Teiler: 89.2 (24.), 94.3 (29.), 143.2 (21.)**  
**Trefferlage: 0.34 mm links, 0.04 mm hoch**  
**Streuwert: 1.57, horizontal: 1.77, vertikal: 1.34**

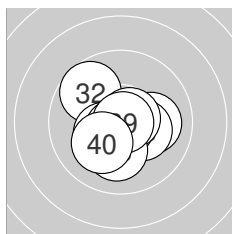

**Serie 4: 103.8 (99)**

10.1 →	9.7 ↘	10.3* ↘	10.8* ↘	10.4* ↗
10.7* ↗	10.7* ↘	10.1 ↓	10.9* →	10.1 ↗

**beste Teiler: 17.2 (39.), 39.8 (34.), 67.1 (37.)**  
**Trefferlage: 0.06 mm links, 0.34 mm tief**  
**Streuwert: 1.23, horizontal: 1.33, vertikal: 1.13**



Ergebnis: **409.5** (391)  
 Serien: 101.3 103.1 101.2 103.9  
 Zähler: 31 9 0 0 0 0 0 0 0 0  
 Innenzehner: 30  
 Weitesten: 356 (24.), 355 (17.), 334 (26.)  
 beste Teiler: 22.8 (40.), 63.6 (25.), 64.4 (13.)  
 Trefferlage: 0.32 mm rechts, 0.12 mm tief  
 Streuwert: 1.39, horizontal: 1.59, vertikal: 1.15

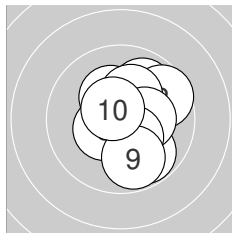
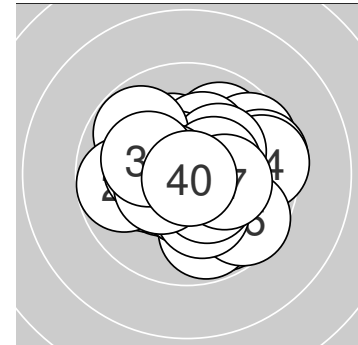

**Serie 1: 101.3 (96)**

9.9 ↗	9.6 ↗	10.3* ↘	10.2* ↗	9.8 ↘
10.3* →	10.4* ↘	10.4* ↙	9.8 ↘	10.6* ↘

beste Teiler: 92.8 (10.), 131.3 (8.), 149.5 (7.)  
 Trefferlage: 0.78 mm rechts, 0.06 mm hoch  
 Streuwert: 1.52, horizontal: 1.26, vertikal: 1.74

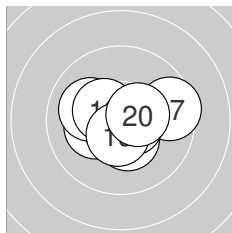

**Serie 2: 103.1 (99)**

10.4* ↖	10.2* ←	10.7* ↙	10.4* ↓	10.0 ↖
10.4* ↖	9.5 →	10.6* →	10.5* ↓	10.4* →

beste Teiler: 64.4 (13.), 81.2 (18.), 102.7 (19.)  
 Trefferlage: 0.09 mm links, 0.04 mm tief  
 Streuwert: 1.30, horizontal: 1.67, vertikal: 0.78

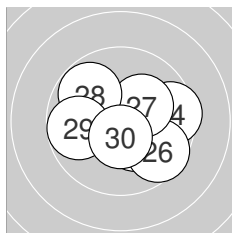

**Serie 3: 101.2 (96)**

10.2* →	10.6* ↘	10.3* ↘	9.5 →	10.7* ↘
9.6 ↘	10.2* ↗	9.8 ↘	9.8 ←	10.5* ↓

beste Teiler: 63.6 (25.), 99.8 (22.), 111.0 (30.)  
 Trefferlage: 0.55 mm rechts, 0.23 mm tief  
 Streuwert: 1.67, horizontal: 2.03, vertikal: 1.21

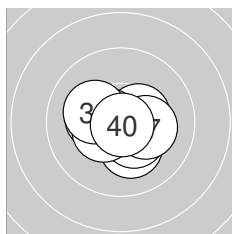

**Serie 4: 103.9 (100)**

10.2* ↓	10.3* ←	10.3* →	10.4* →	10.4* ↘
10.6* ←	10.2* →	10.4* ↙	10.2* ↖	10.9* ↘

beste Teiler: 22.8 (40.), 90.2 (36.), 133.2 (38.)  
 Trefferlage: 0.06 mm rechts, 0.27 mm tief  
 Streuwert: 1.09, horizontal: 1.36, vertikal: 0.73





Ergebnis: **411.3** (390)  
 Serien: 103.1 102.3 100.8 105.1  
 Zähler: 30 10 0 0 0 0 0 0 0 0  
 Innenzehner: 26  
 Weitester: 470 (18.), 416 (25.), 312 (28.)  
 beste Teiler: 5.0 (32.), 8.2 (16.), 29.0 (34.)  
 Trefferlage: 0.44 mm rechts, 0.60 mm tief  
 Streuwert: 1.30, horizontal: 1.39, vertikal: 1.20

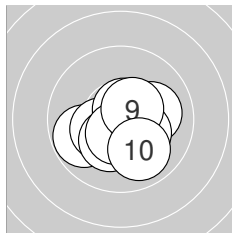
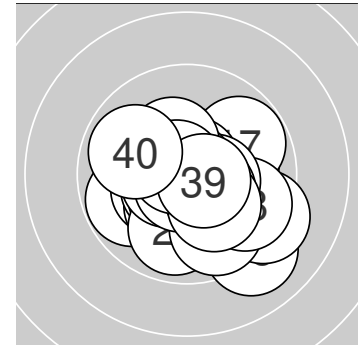

**Serie 1: 103.1 (98)**

9.8 ↙	10.3* ↙	10.3* ↓	10.7* ↘	10.1 →
10.7* ↑	10.3* ↘	10.5* ↓	10.5* ↗	9.9 ↘

beste Teiler: 55.4 (4.), 73.3 (6.), 104.8 (8.)  
 Trefferlage: 0.12 mm rechts, 0.60 mm tief  
 Streuwert: 1.23, horizontal: 1.44, vertikal: 0.98

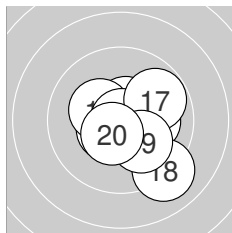

**Serie 2: 102.3 (98)**

10.4* ↗	10.5* ↙	10.1 →	10.6* ↑	10.3* ↖
10.9* →	9.8 ↗	9.1 ↘	10.1 ↘	10.5* ↓

beste Teiler: 8.2 (16.), 96.3 (14.), 114.0 (12.)  
 Trefferlage: 0.76 mm rechts, 0.31 mm tief  
 Streuwert: 1.50, horizontal: 1.53, vertikal: 1.47

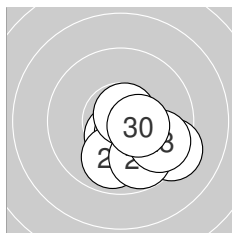

**Serie 3: 100.8 (95)**

10.0 ↓	10.5* ↓	9.9 ↓	10.6* ↓	9.3 ↘
9.9 ↓	9.8 ↘	9.7 ↘	10.7* ↑	10.4* →

beste Teiler: 56.9 (29.), 89.9 (24.), 110.0 (22.)  
 Trefferlage: 1.05 mm rechts, 1.49 mm tief  
 Streuwert: 1.19, horizontal: 1.32, vertikal: 1.05

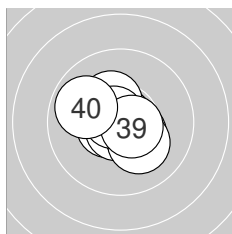

**Serie 4: 105.1 (99)**

10.6* ↙	10.9* →	10.7* ↓	10.8* ↑	10.3* ↖
10.4* ↘	10.2* ↘	10.7* ↖	10.6* →	9.9 ↖

beste Teiler: 5.0 (32.), 29.0 (34.), 59.5 (33.)  
 Trefferlage: 0.16 mm links, 0.02 mm tief  
 Streuwert: 0.99, horizontal: 1.10, vertikal: 0.86



**Ergebnis: 408.8 (390)**  
**Serien: 104.2 100.6 101.7 102.3**  
**Zähler: 31 8 1 0 0 0 0 0 0 0 0**  
**Innenzehner: 27**  
**Weiteste: 566 (13.), 394 (29.), 365 (1.)**  
**beste Teiler: 38.0 (7.), 38.3 (4.), 43.7 (2.)**  
**Trefferlage: 0.04 mm links, 0.01 mm hoch**  
**Streuwert: 1.52, horizontal: 1.44, vertikal: 1.59**

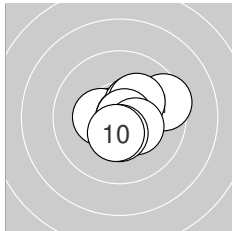
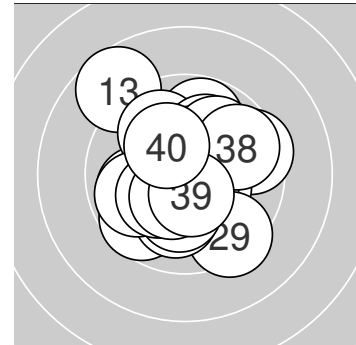

**Serie 1: 104.2 (99)**

9.5 →	10.8* ←	10.4* ←	10.8* →	10.4* ↗
10.2* ↗	10.8* →	10.4* ↘	10.5* ↓	10.4* ↓

**beste Teiler: 38.0 (7.), 38.3 (4.), 43.7 (2.)**  
**Trefferlage: 0.56 mm rechts, 0.03 mm hoch**  
**Streuwert: 1.14, horizontal: 1.33, vertikal: 0.92**

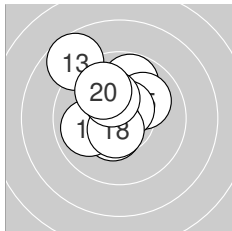

**Serie 2: 100.6 (95)**

10.3* ←	10.5* ↓	8.7 ↘	9.8 ↑	10.0 ↗
10.6* ↗	9.9 ←	10.6* ↓	10.3* ↘	9.9 ↘

**beste Teiler: 89.3 (16.), 93.3 (18.), 123.4 (12.)**  
**Trefferlage: 0.68 mm links, 0.95 mm hoch**  
**Streuwert: 1.72, horizontal: 1.56, vertikal: 1.86**

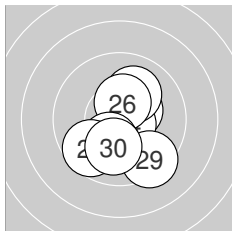

**Serie 3: 101.7 (98)**

10.4* ↗	10.4* ↓	10.3* ↓	10.7* ↘	10.1 ↗
10.4* ↑	10.2* ↓	9.7 ↗	9.4 ↘	10.1 ↓

**beste Teiler: 74.6 (24.), 131.0 (22.), 134.1 (26.)**  
**Trefferlage: 0.17 mm rechts, 0.86 mm tief**  
**Streuwert: 1.50, horizontal: 1.27, vertikal: 1.70**

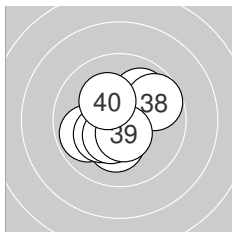

**Serie 4: 102.3 (98)**

10.0 ↗	10.5* ↘	9.9 ←	10.2* ↓	10.7* ←
10.2* ↗	10.4* ↓	9.7 ↗	10.5* ↓	10.2* ↘

**beste Teiler: 57.1 (35.), 106.0 (32.), 109.1 (39.)**  
**Trefferlage: 0.23 mm links, 0.05 mm tief**  
**Streuwert: 1.43, horizontal: 1.49, vertikal: 1.36**



**Ergebnis: 414.2 (395)**  
**Serien: 105.4 102.0 103.0 103.8**  
**Zähler: 35 5 0 0 0 0 0 0 0 0 0**  
**Innenzehner: 33**  
**Weiteste: 286 (13.), 286 (27.), 275 (16.)**  
**beste Teiler: 48.1 (37.), 48.6 (3.), 58.0 (30.)**  
**Trefferlage: 0.85 mm links, 0.31 mm tief**  
**Streuwert: 0.98, horizontal: 1.20, vertikal: 0.69**

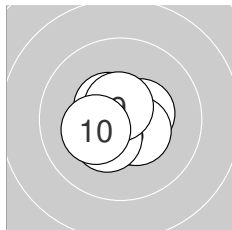
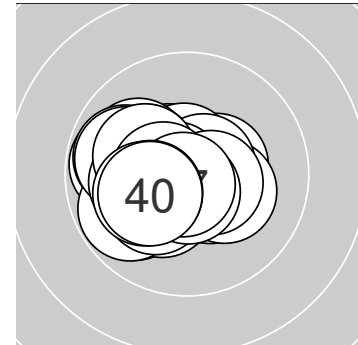

**Serie 1: 105.4 (100)**

10.6* ↘	10.7* →	10.8* ↓	10.7* ↖	10.4* →
10.4* ↘	10.4* ↙	10.5* ↖	10.6* ↑	10.3* ↙

**beste Teiler: 48.6 (3.), 64.5 (2.), 69.7 (4.)**  
**Trefferlage: 0.04 mm links, 0.16 mm tief**  
**Streuwert: 0.82, horizontal: 0.92, vertikal: 0.70**

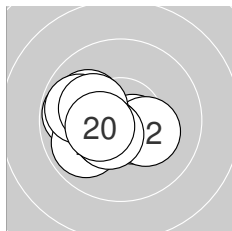

**Serie 2: 102.0 (97)**

10.6* ↘	10.2* ↘	9.8 ←	9.9 ↖	10.0 ↖
9.9 ↖	10.2* ↖	10.5* ↙	10.5* ↙	10.4* ↖

**beste Teiler: 97.2 (11.), 118.6 (19.), 118.8 (18.)**  
**Trefferlage: 1.21 mm links, 0.19 mm tief**  
**Streuwert: 1.20, horizontal: 1.46, vertikal: 0.86**

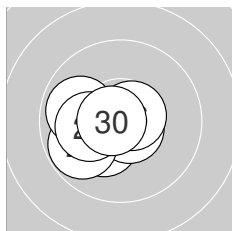

**Serie 3: 103.0 (98)**

10.4* ↙	10.3* ↙	10.2* ←	10.3* ←	10.7* ↘
10.6* →	9.8 ↙	9.9 ↖	10.1 ←	10.7* ↖

**beste Teiler: 58.0 (30.), 73.7 (25.), 79.1 (26.)**  
**Trefferlage: 1.20 mm links, 0.38 mm tief**  
**Streuwert: 0.95, horizontal: 1.16, vertikal: 0.68**

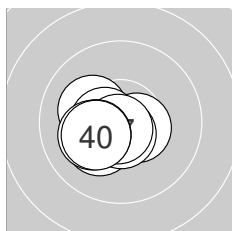

**Serie 4: 103.8 (100)**

10.5* ↘	10.4* ↙	10.2* ↖	10.2* ↙	10.6* ↓
10.5* ←	10.8* ↓	10.2* ↙	10.2* ↙	10.2* ↙

**beste Teiler: 48.1 (37.), 76.1 (35.), 102.0 (36.)**  
**Trefferlage: 0.95 mm links, 0.51 mm tief**  
**Streuwert: 0.78, horizontal: 0.95, vertikal: 0.56**

