

Ergebnis: **401.4** (388)  
 Serien: 101.0 97.9 101.3 101.2  
 Zähler: 28 12 0 0 0 0 0 0 0 0  
 Innenzehner: 19  
 Weitester: 471 (22.), 459 (11.), 452 (20.)  
 beste Teiler: 75.6 (37.), 79.8 (36.), 84.3 (27.)  
 Trefferlage: 0.49 mm rechts, 0.11 mm hoch  
 Streuwert: 1.77, horizontal: 2.16, vertikal: 1.26

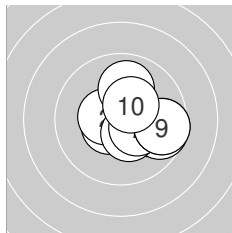
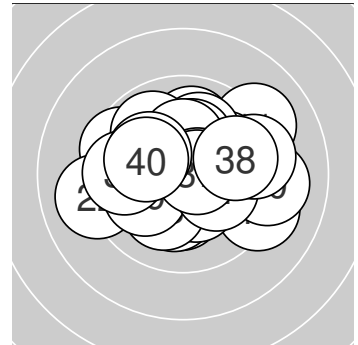

**Serie 1: 101.0 (97)**

|         |         |        |       |         |
|---------|---------|--------|-------|---------|
| 10.5* ↙ | 10.5* ← | 10.0 → | 9.6 → | 10.0 ↑  |
| 10.4* ↘ | 10.4* ↗ | 9.6 →  | 9.6 → | 10.4* ↗ |

beste Teiler: 105.4 (1.), 119.6 (2.), 130.8 (6.)  
 Trefferlage: 1.31 mm rechts, 0.14 mm tief  
 Streuwert: 1.41, horizontal: 1.65, vertikal: 1.12

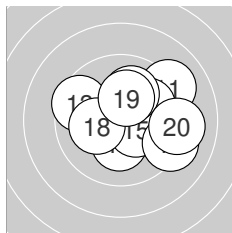

**Serie 2: 97.9 (96)**

|       |         |         |         |         |
|-------|---------|---------|---------|---------|
| 9.1 ↗ | 10.2* ↓ | 9.5 ↖   | 10.0 ↗  | 10.4* ↘ |
| 9.2 ↘ | 10.0 ↑  | 10.2* ← | 10.2* ↑ | 9.1 →   |

beste Teiler: 139.7 (15.), 181.2 (12.), 181.9 (19.)  
 Trefferlage: 1.16 mm rechts, 0.36 mm hoch  
 Streuwert: 2.13, horizontal: 2.54, vertikal: 1.62

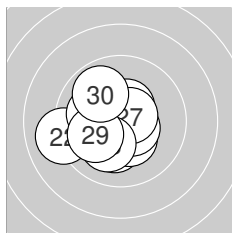

**Serie 3: 101.3 (98)**

|         |         |        |         |         |
|---------|---------|--------|---------|---------|
| 10.2* ↓ | 9.1 ←   | 10.1 ↖ | 10.3* ↓ | 10.5* ↘ |
| 10.5* ↑ | 10.6* ↗ | 10.1 ↙ | 10.0 ←  | 9.9 ↖   |

beste Teiler: 84.3 (27.), 105.8 (25.), 121.8 (26.)  
 Trefferlage: 0.89 mm links, 0.35 mm tief  
 Streuwert: 1.56, horizontal: 1.73, vertikal: 1.36

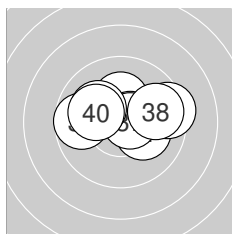

**Serie 4: 101.2 (97)**

|         |         |       |         |         |
|---------|---------|-------|---------|---------|
| 10.2* ↘ | 9.4 →   | 9.7 ← | 10.4* ↗ | 10.2* ↑ |
| 10.6* → | 10.7* → | 9.8 → | 10.1 ↖  | 10.1 ↖  |

beste Teiler: 75.6 (37.), 79.8 (36.), 130.8 (34.)  
 Trefferlage: 0.39 mm rechts, 0.59 mm hoch  
 Streuwert: 1.61, horizontal: 2.17, vertikal: 0.70



Ergebnis: **416.7** (397)  
 Serien: 104.7 104.4 104.5 103.1  
 Zähler: 37 3 0 0 0 0 0 0 0 0  
 Innenzehner: 33  
 Weitester: 298 (19.), 274 (1.), 264 (2.)  
 beste Teiler: 15.8 (8.), 24.2 (21.), 47.3 (22.)  
 Trefferlage: 0.04 mm rechts, 0.36 mm tief  
 Streuwert: 1.06, horizontal: 1.12, vertikal: 0.99

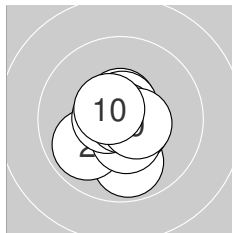
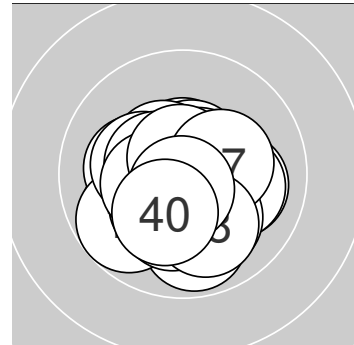

**Serie 1: 104.7 (98)**

|         |         |         |         |         |
|---------|---------|---------|---------|---------|
| 9.9 ↓   | 9.9 ↙   | 10.6* ↑ | 10.6* ↑ | 10.6* ↘ |
| 10.5* ↓ | 10.6* ← | 10.9* ↗ | 10.5* → | 10.6* ↘ |

beste Teiler: 15.8 (8.), 80.7 (4.), 85.3 (7.)  
 Trefferlage: 0.07 mm links, 0.37 mm tief  
 Streuwert: 1.05, horizontal: 0.92, vertikal: 1.17

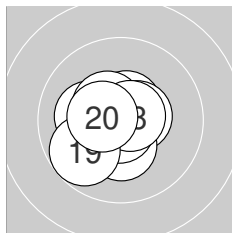

**Serie 2: 104.4 (99)**

|         |         |         |         |         |
|---------|---------|---------|---------|---------|
| 10.6* ↑ | 10.5* ↓ | 10.5* → | 10.3* ↓ | 10.8* ↓ |
| 10.2* ← | 10.5* ↘ | 10.7* ↗ | 9.8 ↙   | 10.5* ← |

beste Teiler: 48.6 (15.), 65.7 (18.), 96.0 (11.)  
 Trefferlage: 0.42 mm links, 0.24 mm tief  
 Streuwert: 1.05, horizontal: 1.10, vertikal: 1.01

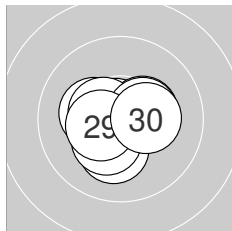

**Serie 3: 104.5 (100)**

|         |         |         |         |         |
|---------|---------|---------|---------|---------|
| 10.9* ↘ | 10.8* ↘ | 10.4* → | 10.2* ↓ | 10.3* ↗ |
| 10.3* ← | 10.5* ← | 10.4* → | 10.4* ← | 10.3* → |

beste Teiler: 24.2 (21.), 47.3 (22.), 116.4 (27.)  
 Trefferlage: 0.11 mm links, 0.16 mm tief  
 Streuwert: 1.02, horizontal: 1.20, vertikal: 0.81

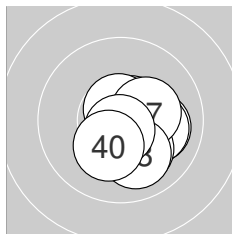

**Serie 4: 103.1 (100)**

|        |         |         |         |         |
|--------|---------|---------|---------|---------|
| 10.0 → | 10.1 →  | 10.6* ↗ | 10.7* ↑ | 10.4* ↓ |
| 10.1 ↘ | 10.3* → | 10.0 ↓  | 10.7* ↓ | 10.2* ↗ |

beste Teiler: 63.3 (39.), 71.0 (34.), 87.2 (33.)  
 Trefferlage: 0.80 mm rechts, 0.66 mm tief  
 Streuwert: 1.00, horizontal: 0.98, vertikal: 1.03



Ergebnis: **411.8** (397)  
 Serien: 104.7 103.3 101.2 102.6  
 Zähler: 37 3 0 0 0 0 0 0 0 0  
 Innenzehner: 27  
 Weitester: 431 (23.), 289 (24.), 251 (13.)  
 beste Teiler: 33.5 (10.), 49.2 (6.), 67.6 (16.)  
 Trefferlage: 0.23 mm rechts, 0.29 mm tief  
 Streuwert: 1.28, horizontal: 1.37, vertikal: 1.18

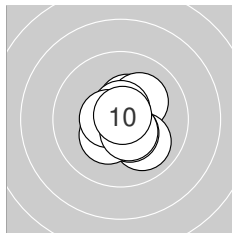
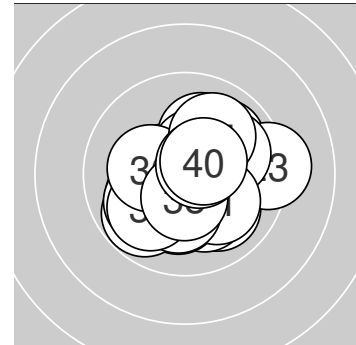

**Serie 1: 104.7 (100)**

|         |         |         |         |         |
|---------|---------|---------|---------|---------|
| 10.4* ↗ | 10.2* ↗ | 10.0 ↘  | 10.7* ↑ | 10.4* ↘ |
| 10.8* ↓ | 10.3* ↘ | 10.6* ← | 10.5* ↘ | 10.8* ↗ |

beste Teiler: 33.5 (10.), 49.2 (6.), 75.0 (4.)  
 Trefferlage: 0.31 mm rechts, 0.17 mm tief  
 Streuwert: 0.99, horizontal: 0.88, vertikal: 1.08

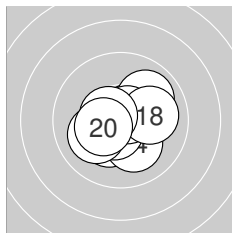

**Serie 2: 103.3 (99)**

|         |         |        |         |         |
|---------|---------|--------|---------|---------|
| 10.6* ↗ | 10.3* ↘ | 9.9 ↗  | 10.1 ↘  | 10.6* ↘ |
| 10.7* ↗ | 10.1 ↘  | 10.0 → | 10.6* ← | 10.4* ← |

beste Teiler: 67.6 (16.), 93.8 (11.), 95.3 (15.)  
 Trefferlage: 0.09 mm rechts, 0.22 mm tief  
 Streuwert: 1.24, horizontal: 1.40, vertikal: 1.07

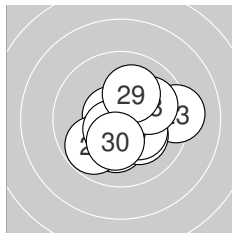

**Serie 3: 101.2 (98)**

|         |         |        |        |         |
|---------|---------|--------|--------|---------|
| 10.2* ↓ | 10.6* ← | 9.2 →  | 9.8 ↘  | 10.5* ↘ |
| 10.2* ↘ | 10.3* ↘ | 10.0 → | 10.1 ↗ | 10.3* ↓ |

beste Teiler: 78.0 (22.), 102.7 (25.), 166.4 (27.)  
 Trefferlage: 0.59 mm rechts, 0.48 mm tief  
 Streuwert: 1.61, horizontal: 1.82, vertikal: 1.35

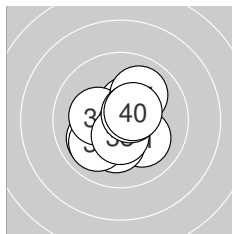

**Serie 4: 102.6 (100)**

|         |         |         |         |         |
|---------|---------|---------|---------|---------|
| 10.1 ↘  | 10.5* ↗ | 10.2* ↓ | 10.0 ↘  | 10.0 ↘  |
| 10.2* ← | 10.0 ↗  | 10.5* ↓ | 10.6* ↗ | 10.5* ↗ |

beste Teiler: 88.7 (39.), 116.4 (40.), 119.0 (38.)  
 Trefferlage: 0.06 mm links, 0.30 mm tief  
 Streuwert: 1.36, horizontal: 1.36, vertikal: 1.36



**Ergebnis: 417.2 (399)**  
**Serien: 103.2 103.8 105.6 104.6**  
**Zähler: 39 1 0 0 0 0 0 0 0 0 0**  
**Innenzehner: 35**  
**Weiteste: 258 (18.), 240 (40.), 208 (12.)**  
**beste Teiler: 7.0 (26.), 33.8 (38.), 50.6 (1.)**  
**Trefferlage: 0.11 mm rechts, 0.00 mm**  
**Streuwert: 1.01, horizontal: 0.92, vertikal: 1.10**

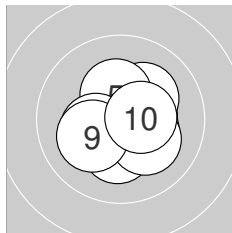
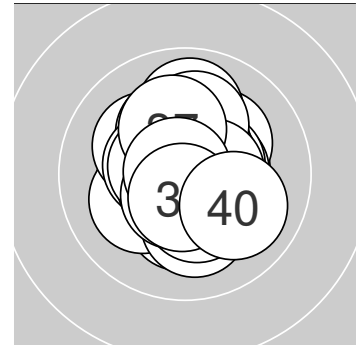

**Serie 1: 103.2 (100)**

|         |         |         |         |         |
|---------|---------|---------|---------|---------|
| 10.8* → | 10.4* → | 10.2* ↗ | 10.3* → | 10.3* ↑ |
| 10.2* ↓ | 10.3* ↖ | 10.2* ↘ | 10.1 ↖  | 10.4* → |

**beste Teiler: 50.6 (1.), 126.5 (10.), 131.1 (2.)**  
**Trefferlage: 0.36 mm rechts, 0.21 mm tief**  
**Streuwert: 1.16, horizontal: 1.25, vertikal: 1.06**

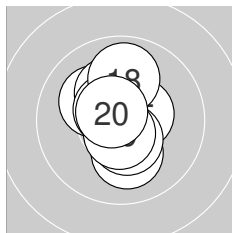

**Serie 2: 103.8 (99)**

|         |         |         |         |         |
|---------|---------|---------|---------|---------|
| 10.2* ↖ | 10.1 ↓  | 10.6* ↖ | 10.2* ↑ | 10.5* → |
| 10.5* ↓ | 10.6* ↖ | 9.9 ↑   | 10.6* ↓ | 10.6* ↖ |

**beste Teiler: 76.4 (20.), 82.2 (19.), 87.4 (13.)**  
**Trefferlage: 0.20 mm links, 0.37 mm hoch**  
**Streuwert: 1.12, horizontal: 0.76, vertikal: 1.38**

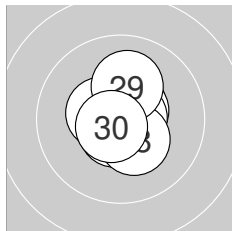

**Serie 3: 105.6 (100)**

|         |         |         |         |         |
|---------|---------|---------|---------|---------|
| 10.5* ↗ | 10.6* ↓ | 10.6* ↗ | 10.7* → | 10.7* ↖ |
| 10.9* ← | 10.5* ↖ | 10.3* ↘ | 10.1 ↑  | 10.7* ↗ |

**beste Teiler: 7.0 (26.), 66.6 (24.), 73.2 (30.)**  
**Trefferlage: 0.03 mm rechts, 0.19 mm hoch**  
**Streuwert: 0.83, horizontal: 0.71, vertikal: 0.93**

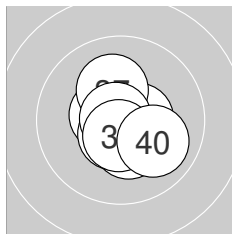

**Serie 4: 104.6 (100)**

|         |         |         |         |         |
|---------|---------|---------|---------|---------|
| 10.5* ↘ | 10.6* → | 10.3* ↓ | 10.5* ↖ | 10.5* → |
| 10.6* ↓ | 10.2* ↑ | 10.8* ↖ | 10.6* ↓ | 10.0 ↘  |

**beste Teiler: 33.8 (38.), 97.0 (36.), 97.7 (39.)**  
**Trefferlage: 0.28 mm rechts, 0.31 mm tief**  
**Streuwert: 0.95, horizontal: 0.91, vertikal: 0.98**



Ergebnis: **419.7** (400)  
 Serien: 104.9 104.4 104.7 105.7  
 Zähler: 40 0 0 0 0 0 0 0 0 0  
 Innenzehner: 38  
 Weitestе: 227 (7.), 226 (22.), 197 (39.)  
 beste Teiler: 7.2 (37.), 18.2 (11.), 22.2 (25.)  
 Trefferlage: 0.36 mm rechts, 0.00 mm  
 Streuwert: 0.91, horizontal: 0.85, vertikal: 0.97

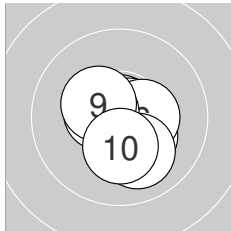
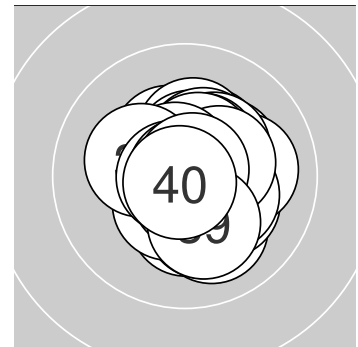

**Serie 1: 104.9 (100)**

|         |         |         |         |         |
|---------|---------|---------|---------|---------|
| 10.7* ↘ | 10.3* ↘ | 10.8* ↑ | 10.7* ↓ | 10.8* → |
| 10.4* → | 10.0 ↓  | 10.5* ← | 10.4* ↖ | 10.3* ↓ |

beste Teiler: 28.0 (3.), 47.8 (5.), 67.5 (1.)  
 Trefferlage: 0.22 mm rechts, 0.44 mm tief  
 Streuwert: 0.91, horizontal: 0.90, vertikal: 0.92

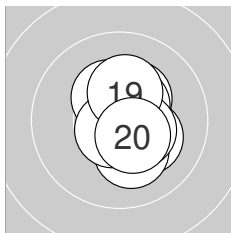

**Serie 2: 104.4 (100)**

|         |         |         |         |         |
|---------|---------|---------|---------|---------|
| 10.9* ↑ | 10.3* ↗ | 10.2* ↘ | 10.5* ↗ | 10.2* ↓ |
| 10.4* ↘ | 10.4* ↖ | 10.7* ↘ | 10.3* ↑ | 10.5* ↘ |

beste Teiler: 18.2 (11.), 72.2 (18.), 115.6 (14.)  
 Trefferlage: 0.50 mm rechts, 0.04 mm hoch  
 Streuwert: 0.97, horizontal: 0.68, vertikal: 1.19

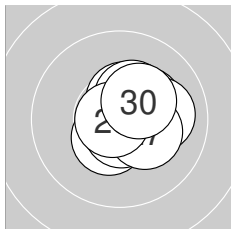

**Serie 3: 104.7 (100)**

|         |         |         |         |         |
|---------|---------|---------|---------|---------|
| 10.3* ↗ | 10.0 →  | 10.5* ↑ | 10.5* ↘ | 10.9* ↘ |
| 10.7* ↓ | 10.3* ↘ | 10.4* ↗ | 10.8* ← | 10.3* ↗ |

beste Teiler: 22.2 (25.), 42.1 (29.), 65.9 (26.)  
 Trefferlage: 0.65 mm rechts, 0.19 mm hoch  
 Streuwert: 0.90, horizontal: 0.93, vertikal: 0.86

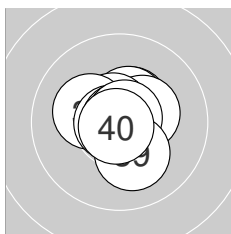

**Serie 4: 105.7 (100)**

|         |         |         |         |         |
|---------|---------|---------|---------|---------|
| 10.5* ↗ | 10.5* ↗ | 10.4* → | 10.6* ↖ | 10.2* ↖ |
| 10.8* ← | 10.9* ↑ | 10.8* ↗ | 10.2* ↓ | 10.8* ↘ |

beste Teiler: 7.2 (37.), 32.6 (40.), 38.9 (38.)  
 Trefferlage: 0.07 mm rechts, 0.21 mm hoch  
 Streuwert: 0.85, horizontal: 0.86, vertikal: 0.84



**Ergebnis: 415.8 (398)**  
**Serien: 103.0 103.7 105.3 103.8**  
**Zähler: 38 2 0 0 0 0 0 0 0 0 0**  
**Innenzehner: 33**  
**Weiteste: 338 (4.), 292 (13.), 234 (31.)**  
**beste Teiler: 25.0 (22.), 43.7 (30.), 62.0 (18.)**  
**Trefferlage: 0.03 mm rechts, 0.13 mm hoch**  
**Streuwert: 1.11, horizontal: 1.24, vertikal: 0.96**

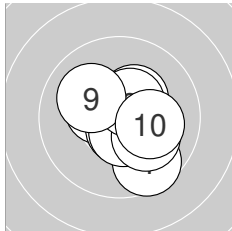
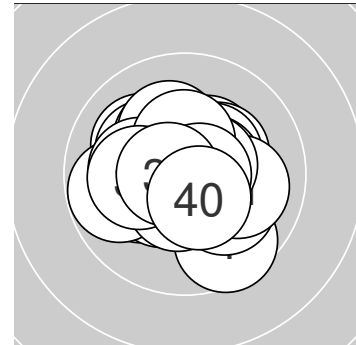

**Serie 1: 103.0 (99)**

|         |         |         |        |         |
|---------|---------|---------|--------|---------|
| 10.4* ↖ | 10.6* ↑ | 10.6* ↓ | 9.6 ↘  | 10.6* ↓ |
| 10.4* ↗ | 10.1 ↘  | 10.5* ↗ | 10.1 ↖ | 10.1 →  |

**beste Teiler: 77.1 (3.), 80.8 (2.), 98.9 (5.)**  
**Trefferlage: 0.43 mm rechts, 0.16 mm tief**  
**Streuwert: 1.30, horizontal: 1.27, vertikal: 1.33**

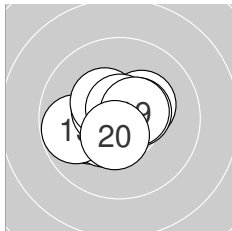

**Serie 2: 103.7 (99)**

|         |         |         |         |         |
|---------|---------|---------|---------|---------|
| 10.1 ←  | 10.4* ↙ | 9.8 ←   | 10.5* ↖ | 10.3* ↗ |
| 10.4* ↘ | 10.5* ↗ | 10.7* ↑ | 10.5* ↗ | 10.5* ↓ |

**beste Teiler: 62.0 (18.), 101.5 (14.), 107.0 (19.)**  
**Trefferlage: 0.43 mm links, 0.03 mm hoch**  
**Streuwert: 1.12, horizontal: 1.37, vertikal: 0.81**

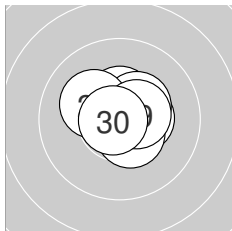

**Serie 3: 105.3 (100)**

|         |         |         |         |         |
|---------|---------|---------|---------|---------|
| 10.5* ↑ | 10.9* ↗ | 10.5* ↑ | 10.6* ↘ | 10.4* → |
| 10.5* ↘ | 10.4* ↗ | 10.2* ↖ | 10.5* → | 10.8* ← |

**beste Teiler: 25.0 (22.), 43.7 (30.), 90.9 (24.)**  
**Trefferlage: 0.34 mm rechts, 0.31 mm hoch**  
**Streuwert: 0.80, horizontal: 0.89, vertikal: 0.70**

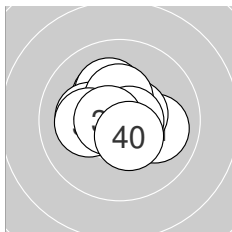

**Serie 4: 103.8 (100)**

|         |         |         |         |         |
|---------|---------|---------|---------|---------|
| 10.0 →  | 10.3* ↘ | 10.2* ↘ | 10.2* ← | 10.6* ↗ |
| 10.4* ↑ | 10.7* → | 10.2* ← | 10.7* ← | 10.5* ↘ |

**beste Teiler: 63.1 (37.), 73.0 (39.), 98.0 (35.)**  
**Trefferlage: 0.18 mm links, 0.35 mm hoch**  
**Streuwert: 1.15, horizontal: 1.33, vertikal: 0.93**



Ergebnis: **384.9** (366)  
 Serien: 96.2 95.9 100.0 92.8 0.0  
 Zähler: 12 23 4 1 0 0 0 0 0 1  
 Innenzehner: 8  
 Weitester: 787 (3.), 559 (32.), 551 (12.)  
 beste Teiler: 96.2 (18.), 108.7 (5.), 120.7 (7.)  
 Trefferlage: 0.82 mm links, 2.85 mm tief  
 Streuwert: 1.51, horizontal: 1.17, vertikal: 1.79

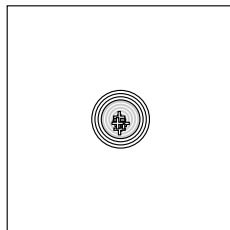
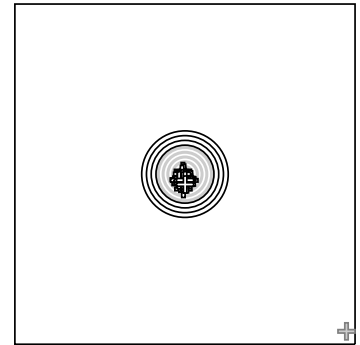

**Serie 1: 96.2 (92)**

|       |         |       |         |         |
|-------|---------|-------|---------|---------|
| 9.6 ↓ | 9.0 ↓   | 7.8 ↓ | 10.1 ↗  | 10.5* ↗ |
| 9.3 ↘ | 10.5* ↗ | 9.8 ↓ | 10.2* ↘ | 9.4 ↗   |

beste Teiler: 108.7 (5.), 120.7 (7.), 194.4 (9.)  
 Trefferlage: 0.67 mm links, 2.66 mm tief  
 Streuwert: 2.01, horizontal: 1.24, vertikal: 2.56

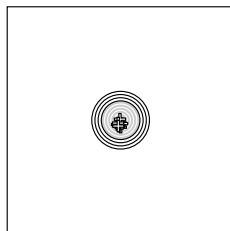

**Serie 2: 95.9 (92)**

|        |       |         |       |       |
|--------|-------|---------|-------|-------|
| 10.0 ↓ | 8.7 ↓ | 10.0 ↓  | 9.2 ↗ | 9.8 ↓ |
| 9.0 ↓  | 9.8 ↘ | 10.6* ↘ | 9.8 ↗ | 9.0 ↓ |

beste Teiler: 96.2 (18.), 231.3 (13.), 232.2 (11.)  
 Trefferlage: 0.85 mm links, 2.95 mm tief  
 Streuwert: 1.48, horizontal: 1.10, vertikal: 1.77

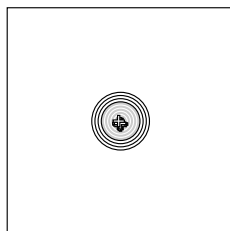

**Serie 3: 100.0 (95)**

|         |       |       |         |         |
|---------|-------|-------|---------|---------|
| 10.3* ↓ | 9.9 ↘ | 9.8 ↗ | 9.9 ↗   | 10.1 ↓  |
| 10.2* ↓ | 9.6 ↓ | 9.7 ↓ | 10.2* ↓ | 10.3* ← |

beste Teiler: 151.1 (30.), 170.1 (21.), 186.3 (29.)  
 Trefferlage: 0.48 mm links, 2.04 mm tief  
 Streuwert: 0.95, horizontal: 0.96, vertikal: 0.93

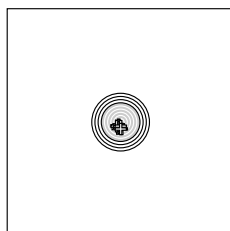

**Serie 4: 92.8 (87)**

|       |       |       |       |       |
|-------|-------|-------|-------|-------|
| 9.9 ↗ | 8.7 ↓ | 9.2 ↗ | 9.9 ↗ | 8.8 ↓ |
| 9.2 ↗ | 9.1 ↓ | 9.5 ↓ | 9.7 ↓ | 8.8 ↓ |

beste Teiler: 257.4 (31.), 271.8 (34.), 318.0 (39.)  
 Trefferlage: 1.26 mm links, 3.74 mm tief  
 Streuwert: 1.31, horizontal: 1.37, vertikal: 1.25

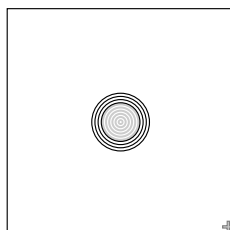

**Serie 5: 0.0 (0)**

0.0+ ↘  
AST, NSC  
 beste Teiler:  
 Trefferlage: 0.00 mm , 0.00 mm  
 Streuwert: 0.00, horizontal: 0.00, vertikal: 0.00

AST - Treffer wurde nach Ende der Schießzeit abgegeben  
 NSC - Treffer wurde vermessen, geht aber nicht in die Wertung ein



Ergebnis: **413.8** (397)  
 Serien: 104.8 103.2 103.8 102.0  
 Zähler: 37 3 0 0 0 0 0 0 0 0  
 Innenzehner: 27  
 Weitestе: 365 (38.), 276 (37.), 254 (23.)  
 beste Teiler: 21.2 (1.), 44.2 (27.), 46.5 (36.)  
 Trefferlage: 0.09 mm links, 0.20 mm tief  
 Streuwert: 1.21, horizontal: 1.01, vertikal: 1.38

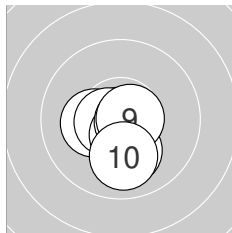
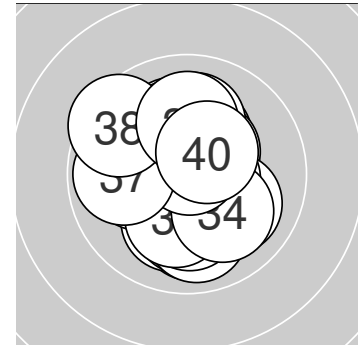

**Serie 1: 104.8 (100)**

|         |         |         |         |         |
|---------|---------|---------|---------|---------|
| 10.9* ↙ | 10.4* ↓ | 10.6* ↓ | 10.3* ← | 10.6* ← |
| 10.5* ↓ | 10.7* ↘ | 10.1 ↓  | 10.7* → | 10.0 ↓  |

beste Teiler: 21.2 (1.), 53.7 (7.), 63.1 (9.)  
 Trefferlage: 0.06 mm links, 0.83 mm tief  
 Streuwert: 0.79, horizontal: 0.71, vertikal: 0.87

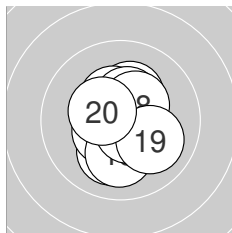

**Serie 2: 103.2 (100)**

|         |         |         |         |         |
|---------|---------|---------|---------|---------|
| 10.1 ↓  | 10.5* ↙ | 10.1 ↓  | 10.3* ↑ | 10.4* ↖ |
| 10.6* ↘ | 10.4* ↑ | 10.4* ↗ | 10.0 ↘  | 10.4* ↗ |

beste Teiler: 80.7 (16.), 119.4 (12.), 135.0 (20.)  
 Trefferlage: 0.10 mm rechts, 0.09 mm tief  
 Streuwert: 1.23, horizontal: 0.97, vertikal: 1.44

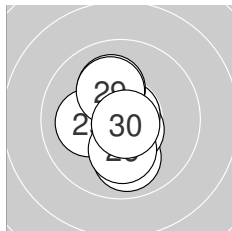

**Serie 3: 103.8 (99)**

|         |         |        |         |         |
|---------|---------|--------|---------|---------|
| 10.5* ↓ | 10.6* ↖ | 9.9 ↓  | 10.6* ↘ | 10.1 ←  |
| 10.2* ↓ | 10.8* ↗ | 10.1 ↑ | 10.2* ↖ | 10.8* ↘ |

beste Teiler: 44.2 (27.), 46.6 (30.), 93.5 (24.)  
 Trefferlage: 0.17 mm links, 0.20 mm tief  
 Streuwert: 1.20, horizontal: 0.81, vertikal: 1.49

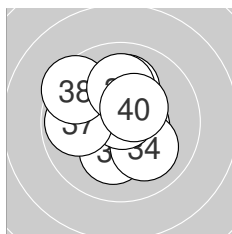

**Serie 4: 102.0 (98)**

|         |         |         |        |         |
|---------|---------|---------|--------|---------|
| 10.5* ↓ | 10.6* ↘ | 10.2* ↓ | 10.1 ↘ | 10.1 ↑  |
| 10.8* ↑ | 9.8 ←   | 9.5 ↘   | 10.0 ↑ | 10.4* ↗ |

beste Teiler: 46.5 (36.), 100.4 (32.), 113.2 (31.)  
 Trefferlage: 0.25 mm links, 0.32 mm hoch  
 Streuwert: 1.53, horizontal: 1.50, vertikal: 1.56





**Ergebnis: 411.5 (392)**  
**Serien: 104.0 102.2 102.8 102.5**  
**Zähler: 32 8 0 0 0 0 0 0 0 0 0**  
**Innenzehner: 28**  
**Weiteste: 301 (36.), 300 (11.), 290 (13.)**  
**beste Teiler: 61.2 (9.), 67.4 (25.), 74.4 (3.)**  
**Trefferlage: 0.54 mm rechts, 0.07 mm hoch**  
**Streuwert: 1.22, horizontal: 1.30, vertikal: 1.15**

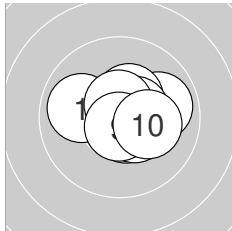
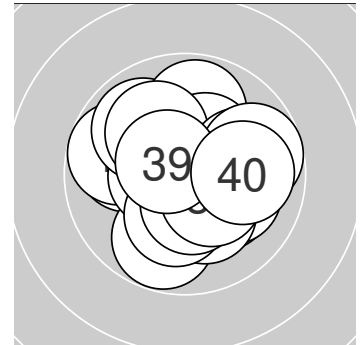

**Serie 1: 104.0 (98)**

|         |         |         |         |         |
|---------|---------|---------|---------|---------|
| 9.9 ←   | 9.9 →   | 10.7* → | 10.4* ↗ | 10.6* ↘ |
| 10.5* ↗ | 10.5* ↘ | 10.6* ↑ | 10.7* ↓ | 10.2* → |

**beste Teiler: 61.2 (9.), 74.4 (3.), 83.2 (8.)**  
**Trefferlage: 0.54 mm rechts, 0.13 mm hoch**  
**Streuwert: 1.07, horizontal: 1.33, vertikal: 0.73**

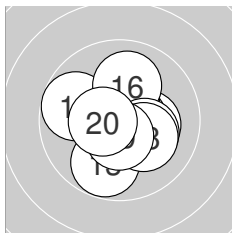

**Serie 2: 102.2 (98)**

|        |         |         |         |         |
|--------|---------|---------|---------|---------|
| 9.8 ←  | 10.2* → | 9.8 ↓   | 10.6* → | 10.4* ↑ |
| 10.0 ↑ | 10.2* ↘ | 10.2* ↘ | 10.5* ↓ | 10.5* ← |

**beste Teiler: 79.6 (14.), 101.0 (19.), 110.3 (20.)**  
**Trefferlage: 0.16 mm rechts, 0.15 mm tief**  
**Streuwert: 1.43, horizontal: 1.46, vertikal: 1.41**

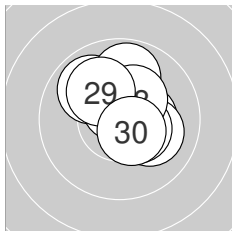

**Serie 3: 102.8 (98)**

|         |         |         |        |         |
|---------|---------|---------|--------|---------|
| 10.3* → | 9.9 ↘   | 9.9 ↑   | 10.1 → | 10.7* ↗ |
| 10.4* ↘ | 10.6* ↑ | 10.3* ↗ | 10.1 ↘ | 10.5* ↘ |

**beste Teiler: 67.4 (25.), 84.6 (27.), 109.6 (30.)**  
**Trefferlage: 0.38 mm rechts, 0.69 mm hoch**  
**Streuwert: 1.21, horizontal: 1.18, vertikal: 1.24**

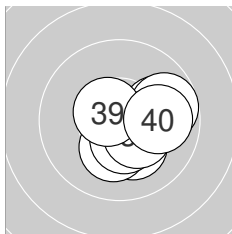

**Serie 4: 102.5 (98)**

|         |         |         |         |        |
|---------|---------|---------|---------|--------|
| 10.2* ↓ | 10.2* ↓ | 10.6* → | 10.4* ↓ | 10.0 → |
| 9.7 →   | 10.5* ↘ | 10.4* ↘ | 10.6* ↘ | 9.9 →  |

**beste Teiler: 84.1 (33.), 94.8 (39.), 109.3 (37.)**  
**Trefferlage: 1.08 mm rechts, 0.39 mm tief**  
**Streuwert: 1.10, horizontal: 1.22, vertikal: 0.96**



**Ergebnis: 407.1 (388)**  
**Serien: 103.2 100.9 100.0 103.0**  
**Zähler: 29 10 1 0 0 0 0 0 0 0**  
**Innenzehner: 22**  
**Weiteste: 520 (18.), 451 (12.), 331 (28.)**  
**beste Teiler: 13.8 (19.), 40.0 (36.), 54.4 (5.)**  
**Trefferlage: 0.33 mm links, 0.17 mm hoch**  
**Streuwert: 1.55, horizontal: 1.70, vertikal: 1.37**

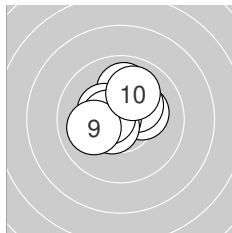
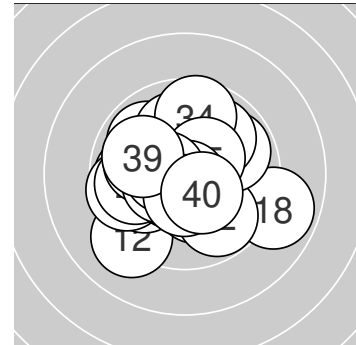

**Serie 1: 103.2 (100)**

|         |         |         |         |         |
|---------|---------|---------|---------|---------|
| 10.0 ↑  | 10.6* ← | 10.2* → | 10.3* ↗ | 10.7* ← |
| 10.3* ↖ | 10.6* ↗ | 10.5* ← | 10.0 ←  | 10.0 ↑  |

**beste Teiler: 54.4 (5.), 80.1 (2.), 92.8 (7.)**  
**Trefferlage: 0.22 mm links, 0.58 mm hoch**  
**Streuwert: 1.16, horizontal: 1.26, vertikal: 1.06**

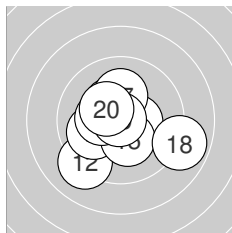

**Serie 2: 100.9 (97)**

|         |        |         |         |         |
|---------|--------|---------|---------|---------|
| 10.5* → | 9.1 ↗  | 10.4* ↘ | 10.0 ←  | 10.3* ↓ |
| 10.3* ← | 10.1 ↑ | 8.9 →   | 10.9* ↖ | 10.4* ↘ |

**beste Teiler: 13.8 (19.), 124.7 (11.), 148.6 (20.)**  
**Trefferlage: 0.21 mm links, 0.35 mm tief**  
**Streuwert: 1.93, horizontal: 2.18, vertikal: 1.63**

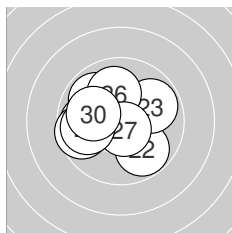

**Serie 3: 100.0 (94)**

|         |         |       |       |        |
|---------|---------|-------|-------|--------|
| 10.5* → | 9.8 ↘   | 9.8 → | 9.9 ↖ | 9.9 ←  |
| 10.0 ↑  | 10.7* ↓ | 9.6 ← | 9.8 ← | 10.0 ← |

**beste Teiler: 71.6 (27.), 112.0 (21.), 232.4 (30.)**  
**Trefferlage: 0.78 mm links, 0.13 mm hoch**  
**Streuwert: 1.76, horizontal: 2.09, vertikal: 1.36**

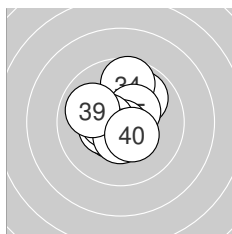

**Serie 4: 103.0 (97)**

|         |         |         |       |         |
|---------|---------|---------|-------|---------|
| 10.5* ↗ | 10.4* ← | 9.9 ↗   | 9.7 ↑ | 10.4* ↗ |
| 10.8* ↓ | 10.5* ← | 10.5* ↓ | 9.9 ↖ | 10.4* ↘ |

**beste Teiler: 40.0 (36.), 102.6 (31.), 112.5 (37.)**  
**Trefferlage: 0.10 mm links, 0.32 mm hoch**  
**Streuwert: 1.33, horizontal: 1.23, vertikal: 1.41**



Ergebnis: **412.6** (395)  
 Serien: 104.3 104.6 100.2 103.5  
 Zähler: 35 5 0 0 0 0 0 0 0 0  
 Innenzehner: 26  
 Weitest: 440 (26.), 396 (27.), 363 (25.)  
 beste Teiler: 16.0 (5.), 20.1 (11.), 32.5 (4.)  
 Trefferlage: 0.26 mm rechts, 0.04 mm hoch  
 Streuwert: 1.35, horizontal: 1.61, vertikal: 1.02

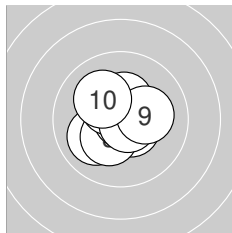
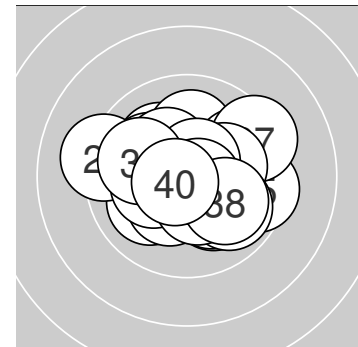

**Serie 1: 104.3 (100)**

|         |         |         |         |         |
|---------|---------|---------|---------|---------|
| 10.5* ↘ | 10.0 ↙  | 10.3* ↗ | 10.8* → | 10.9* → |
| 10.4* ↖ | 10.4* ↑ | 10.7* ↘ | 10.2* → | 10.1 ↘  |

beste Teiler: 16.0 (5.), 32.5 (4.), 65.0 (8.)  
 Trefferlage: 0.10 mm links, 0.05 mm hoch  
 Streuwert: 1.09, horizontal: 1.14, vertikal: 1.04

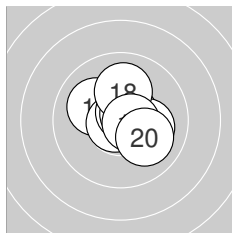

**Serie 2: 104.6 (100)**

|         |         |        |         |         |
|---------|---------|--------|---------|---------|
| 10.9* ↗ | 10.7* ↗ | 10.1 ↖ | 10.8* ↙ | 10.7* ↑ |
| 10.6* ↗ | 10.1 →  | 10.1 ↑ | 10.6* → | 10.0 ↘  |

beste Teiler: 20.1 (11.), 48.7 (14.), 68.2 (12.)  
 Trefferlage: 0.40 mm rechts, 0.27 mm hoch  
 Streuwert: 1.03, horizontal: 1.10, vertikal: 0.96

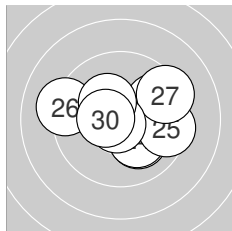

**Serie 3: 100.2 (96)**

|         |       |         |         |         |
|---------|-------|---------|---------|---------|
| 10.4* ↖ | 9.8 ↗ | 10.1 ↘  | 10.2* ↘ | 9.5 →   |
| 9.2 ←   | 9.4 ↗ | 10.8* ↗ | 10.3* ↖ | 10.5* ← |

beste Teiler: 47.0 (28.), 116.2 (30.), 144.7 (21.)  
 Trefferlage: 0.42 mm rechts, 0.21 mm hoch  
 Streuwert: 1.96, horizontal: 2.49, vertikal: 1.22

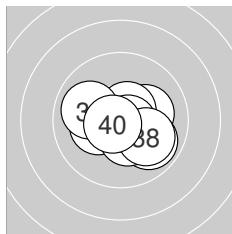

**Serie 4: 103.5 (99)**

|         |         |         |        |         |
|---------|---------|---------|--------|---------|
| 10.2* → | 10.8* ↘ | 10.2* ← | 9.9 ↘  | 10.4* ↘ |
| 10.6* ↗ | 10.7* ↘ | 10.0 ↘  | 10.0 ← | 10.7* ↗ |

beste Teiler: 39.6 (32.), 65.2 (37.), 69.3 (40.)  
 Trefferlage: 0.32 mm rechts, 0.34 mm tief  
 Streuwert: 1.24, horizontal: 1.53, vertikal: 0.85



**Ergebnis: 406.0 (386)**  
**Serien: 104.5 98.7 102.3 100.5**  
**Zähler: 28 11 0 1 0 0 0 0 0 0**  
**Innenzehner: 24**  
**Weiteste: 981 (15.), 443 (32.), 431 (17.)**  
**beste Teiler: 28.0 (20.), 34.0 (28.), 49.6 (31.)**  
**Trefferlage: 0.37 mm links, 0.16 mm tief**  
**Streuwert: 1.83, horizontal: 2.28, vertikal: 1.21**

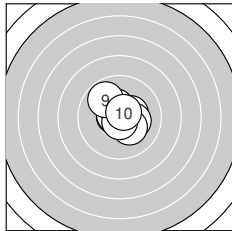
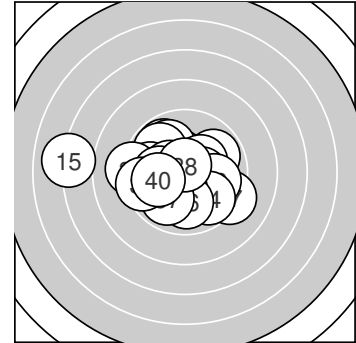

**Serie 1: 104.5 (99)**

|         |         |         |         |         |
|---------|---------|---------|---------|---------|
| 10.7* ← | 10.4* → | 10.2* → | 10.7* ↖ | 10.7* ↖ |
| 10.4* ↖ | 10.3* ↘ | 10.7* ↓ | 9.8 ↖   | 10.6* ↗ |

**beste Teiler: 56.0 (8.), 67.8 (1.), 71.0 (4.)**  
**Trefferlage: 0.07 mm rechts, 0.32 mm hoch**  
**Streuwert: 1.04, horizontal: 1.11, vertikal: 0.97**

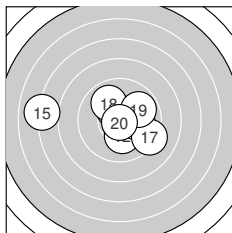

**Serie 2: 98.7 (94)**

|         |         |         |        |         |
|---------|---------|---------|--------|---------|
| 10.5* ↘ | 10.2* ↓ | 10.7* → | 10.1 → | 7.0 ←   |
| 10.4* ↖ | 9.2 ↘   | 9.9 ↖   | 9.9 ↗  | 10.8* ↓ |

**beste Teiler: 28.0 (20.), 64.0 (13.), 124.4 (11.)**  
**Trefferlage: 0.17 mm links, 0.02 mm hoch**  
**Streuwert: 2.80, horizontal: 3.70, vertikal: 1.43**

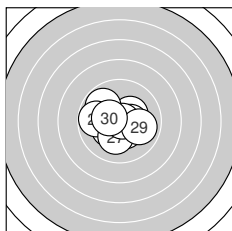

**Serie 3: 102.3 (97)**

|         |         |         |       |         |
|---------|---------|---------|-------|---------|
| 10.3* ↗ | 10.4* → | 10.3* ↖ | 9.8 ↖ | 9.8 ←   |
| 10.4* ↘ | 10.2* ↓ | 10.8* → | 9.9 → | 10.4* ↖ |

**beste Teiler: 34.0 (28.), 135.3 (30.), 136.6 (22.)**  
**Trefferlage: 0.18 mm links, 0.15 mm tief**  
**Streuwert: 1.44, horizontal: 1.71, vertikal: 1.10**

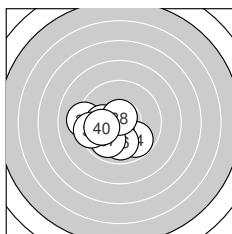

**Serie 4: 100.5 (96)**

|         |       |         |       |         |
|---------|-------|---------|-------|---------|
| 10.8* ↖ | 9.2 ← | 10.1 ←  | 9.8 ↘ | 10.5* ↓ |
| 10.0 ↓  | 9.9 ↗ | 10.7* ↑ | 9.5 ← | 10.0 ←  |

**beste Teiler: 49.6 (31.), 60.0 (38.), 123.3 (35.)**  
**Trefferlage: 1.23 mm links, 0.83 mm tief**  
**Streuwert: 1.58, horizontal: 1.91, vertikal: 1.16**



**Ergebnis: 418.8 (399)**  
**Serien: 104.3 104.7 105.1 104.7**  
**Zähler: 39 1 0 0 0 0 0 0 0 0**  
**Innenzehner: 32**  
**Weiteste: 287 (7.), 246 (10.), 219 (26.)**  
**beste Teiler: 11.1 (25.), 16.6 (13.), 25.0 (38.)**  
**Trefferlage: 0.26 mm links, 0.04 mm hoch**  
**Streuwert: 0.99, horizontal: 1.13, vertikal: 0.84**

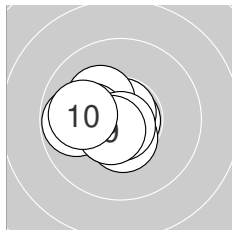
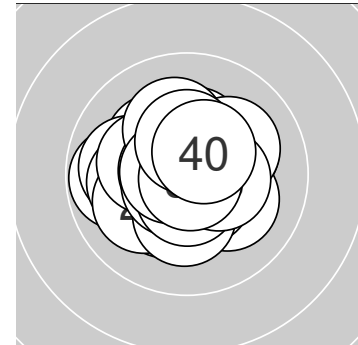

**Serie 1: 104.3 (99)**

|         |         |         |         |         |
|---------|---------|---------|---------|---------|
| 10.8* → | 10.6* ↙ | 10.8* ↑ | 10.2* ↖ | 10.5* ↓ |
| 10.2* ← | 9.8 ←   | 10.8* ↓ | 10.6* ↘ | 10.0 ←  |

**beste Teiler: 35.1 (1.), 42.4 (3.), 45.0 (8.)**  
**Trefferlage: 0.92 mm links, 0.12 mm tief**  
**Streuwert: 0.95, horizontal: 1.16, vertikal: 0.69**

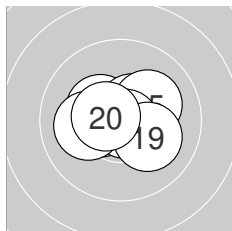

**Serie 2: 104.7 (100)**

|         |         |         |         |         |
|---------|---------|---------|---------|---------|
| 10.4* ↖ | 10.7* → | 10.9* ↗ | 10.5* ↗ | 10.1 ↗  |
| 10.5* ← | 10.8* ↘ | 10.1 ←  | 10.1 ↘  | 10.6* ← |

**beste Teiler: 16.6 (13.), 36.2 (17.), 57.0 (12.)**  
**Trefferlage: 0.04 mm links, 0.10 mm hoch**  
**Streuwert: 1.03, horizontal: 1.32, vertikal: 0.62**

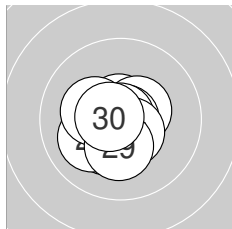

**Serie 3: 105.1 (100)**

|         |         |         |         |         |
|---------|---------|---------|---------|---------|
| 10.7* ↑ | 10.5* ↗ | 10.8* → | 10.3* ↙ | 10.9* ↖ |
| 10.1 ↙  | 10.5* ↘ | 10.3* ← | 10.3* ↓ | 10.7* ← |

**beste Teiler: 11.1 (25.), 26.0 (23.), 69.8 (21.)**  
**Trefferlage: 0.35 mm links, 0.31 mm tief**  
**Streuwert: 0.92, horizontal: 0.94, vertikal: 0.89**

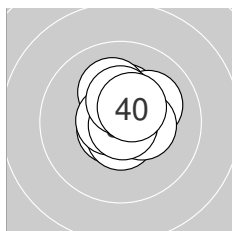

**Serie 4: 104.7 (100)**

|         |         |         |         |         |
|---------|---------|---------|---------|---------|
| 10.7* ↙ | 10.6* ↓ | 10.3* ↑ | 10.1 ↗  | 10.1 ↑  |
| 10.4* → | 10.7* ← | 10.9* ↘ | 10.4* ↑ | 10.5* ↗ |

**beste Teiler: 25.0 (38.), 67.7 (37.), 75.6 (31.)**  
**Trefferlage: 0.25 mm rechts, 0.53 mm hoch**  
**Streuwert: 0.90, horizontal: 0.83, vertikal: 0.97**



**LG 40 ZR**

StandNr: 113

**Juen, Stefan** #70817491

**Senioren\_1m**

Wertung

**StartNr: 109**

05.03.2023 14:35

SG\_See

Ergebnis: **0.0** (0)<sub>DNS</sub>  
Serien:  
Zähler: 0 0 0 0 0 0 0 0 0 0 0  
Innenzehner: 0  
Weiteste:  
~~beste Teiler~~  
Trefferlage: 0.00 mm , 0.00 mm  
Streuwert:

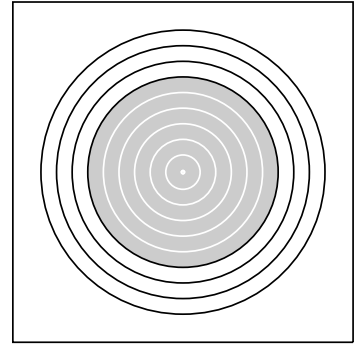

Ergebnis: **411.0** (393)  
 Serien: 102.3 104.0 102.5 102.2  
 Zähler: 34 5 1 0 0 0 0 0 0 0  
 Innenzehner: 28  
 Weitestе: 502 (32.), 342 (9.), 330 (6.)  
 beste Teiler: 14.8 (11.), 46.0 (4.), 50.9 (2.)  
 Trefferlage: 0.25 mm rechts, 0.61 mm tief  
 Streuwert: 1.30, horizontal: 1.48, vertikal: 1.09

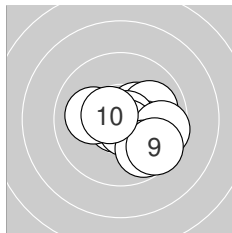
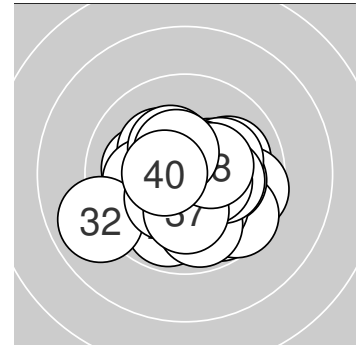

**Serie 1: 102.3 (97)**

|         |         |        |         |         |
|---------|---------|--------|---------|---------|
| 10.4* ↗ | 10.8* ↙ | 10.0 → | 10.8* → | 10.6* ↘ |
| 9.6 →   | 10.1 ←  | 9.8 ↘  | 9.6 ↘   | 10.6* ← |

beste Teiler: 46.0 (4.), 50.9 (2.), 82.9 (5.)  
 Trefferlage: 0.87 mm rechts, 0.42 mm tief  
 Streuwert: 1.42, horizontal: 1.69, vertikal: 1.09

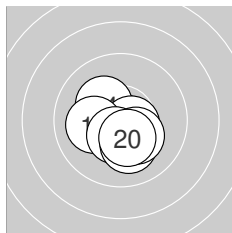

**Serie 2: 104.0 (100)**

|         |         |         |         |         |
|---------|---------|---------|---------|---------|
| 10.9* ↙ | 10.3* ← | 10.7* ↓ | 10.2* ↖ | 10.6* → |
| 10.1 ←  | 10.4* ↙ | 10.1 ↓  | 10.3* ↘ | 10.4* ↘ |

beste Teiler: 14.8 (11.), 69.1 (13.), 89.6 (15.)  
 Trefferlage: 0.25 mm links, 0.60 mm tief  
 Streuwert: 1.00, horizontal: 1.10, vertikal: 0.89

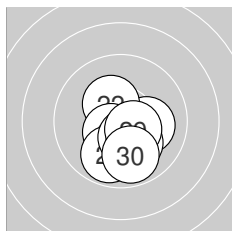

**Serie 3: 102.5 (98)**

|        |         |         |         |         |
|--------|---------|---------|---------|---------|
| 10.1 → | 10.3* ↖ | 10.3* ↓ | 10.5* ↘ | 10.5* ↗ |
| 9.9 ↙  | 10.4* ↘ | 10.1 ↘  | 10.5* ↘ | 9.9 ↘   |

beste Teiler: 114.1 (25.), 117.8 (29.), 123.0 (24.)  
 Trefferlage: 0.36 mm rechts, 1.11 mm tief  
 Streuwert: 1.08, horizontal: 0.99, vertikal: 1.17

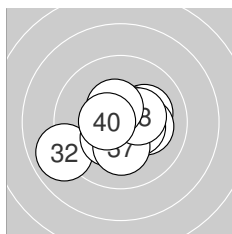

**Serie 4: 102.2 (98)**

|         |         |         |         |         |
|---------|---------|---------|---------|---------|
| 10.2* ↗ | 8.9 ↙   | 10.2* → | 10.4* → | 10.3* ↗ |
| 10.6* ↗ | 10.2* ↓ | 10.4* → | 10.5* ↖ | 10.5* ← |

beste Teiler: 89.2 (36.), 107.1 (40.), 122.9 (39.)  
 Trefferlage: 0.02 mm rechts, 0.33 mm tief  
 Streuwert: 1.59, horizontal: 1.92, vertikal: 1.18



**Ergebnis: 413.1 (395)**  
**Serien: 102.8 103.7 103.1 103.5**  
**Zähler: 35 5 0 0 0 0 0 0 0 0 0**  
**Innenzehner: 28**  
**Weiteste: 398 (21.), 314 (14.), 300 (1.)**  
**beste Teiler: 8.6 (30.), 9.0 (15.), 54.5 (34.)**  
**Trefferlage: 0.30 mm links, 0.45 mm hoch**  
**Streuwert: 1.22, horizontal: 1.19, vertikal: 1.24**

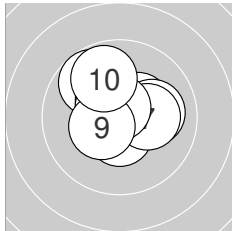
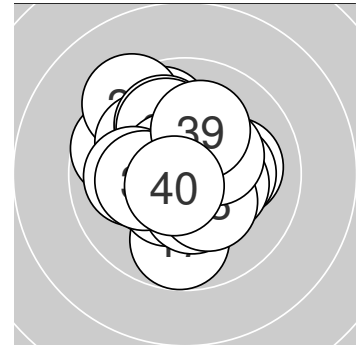

**Serie 1: 102.8 (98)**

|         |         |         |         |        |
|---------|---------|---------|---------|--------|
| 9.8 ↖   | 10.4* ↗ | 10.5* ↓ | 10.4* ↖ | 10.1 → |
| 10.5* ↖ | 10.2* → | 10.7* ↑ | 10.4* ↗ | 9.8 ↖  |

**beste Teiler: 66.2 (8.), 104.6 (6.), 108.0 (3.)**  
**Trefferlage: 0.05 mm links, 0.69 mm hoch**  
**Streuwert: 1.27, horizontal: 1.38, vertikal: 1.16**

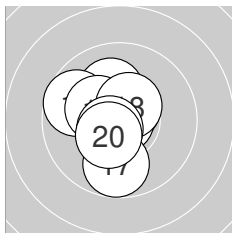

**Serie 2: 103.7 (98)**

|         |         |         |         |         |
|---------|---------|---------|---------|---------|
| 10.7* ↖ | 10.6* ↗ | 10.1 ↑  | 9.7 ↖   | 10.9* → |
| 10.3* ↖ | 9.8 ↓   | 10.5* ↗ | 10.6* ↗ | 10.5* ↗ |

**beste Teiler: 9.0 (15.), 74.0 (11.), 89.1 (19.)**  
**Trefferlage: 0.58 mm links, 0.16 mm hoch**  
**Streuwert: 1.23, horizontal: 1.03, vertikal: 1.40**

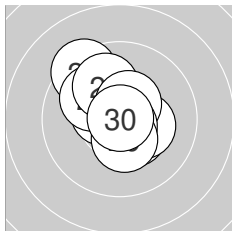

**Serie 3: 103.1 (99)**

|         |         |         |         |         |
|---------|---------|---------|---------|---------|
| 9.4 ↖   | 10.5* ↖ | 10.0 ↖  | 10.4* ↘ | 10.0 ↖  |
| 10.3* → | 10.5* ↗ | 10.7* ↘ | 10.4* ↓ | 10.9* ↗ |

**beste Teiler: 8.6 (30.), 54.9 (28.), 117.0 (22.)**  
**Trefferlage: 0.24 mm links, 0.51 mm hoch**  
**Streuwert: 1.36, horizontal: 1.26, vertikal: 1.45**

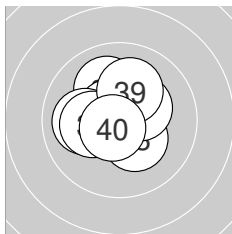

**Serie 4: 103.5 (100)**

|        |         |         |         |         |
|--------|---------|---------|---------|---------|
| 10.1 ↖ | 10.5* ↑ | 10.3* ↘ | 10.7* ← | 10.6* ↖ |
| 10.0 ← | 10.3* ↗ | 10.2* ← | 10.1 ↑  | 10.7* ↗ |

**beste Teiler: 54.5 (34.), 71.5 (40.), 83.7 (35.)**  
**Trefferlage: 0.33 mm links, 0.45 mm hoch**  
**Streuwert: 1.13, horizontal: 1.19, vertikal: 1.08**





Ergebnis: **403.7** (388)  
 Serien: 102.3 100.7 99.7 101.0  
 Zähler: 28 12 0 0 0 0 0 0 0 0  
 Innenzehner: 19  
 Weitester: 427 (29.), 391 (33.), 377 (25.)  
 beste Teiler: 43.1 (37.), 67.2 (2.), 76.0 (4.)  
 Trefferlage: 0.86 mm links, 0.11 mm tief  
 Streuwert: 1.55, horizontal: 1.78, vertikal: 1.27

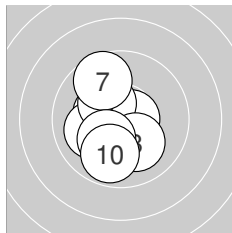
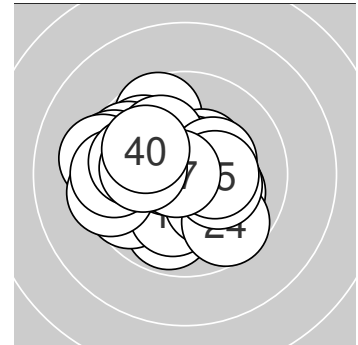

**Serie 1: 102.3 (98)**

|         |         |         |         |        |
|---------|---------|---------|---------|--------|
| 10.3* ↖ | 10.7* ↓ | 10.4* ← | 10.6* → | 10.1 ↖ |
| 10.3* ↘ | 9.7 ↗   | 10.1 ↘  | 10.2* ↗ | 9.9 ↓  |

beste Teiler: 67.2 (2.), 76.0 (4.), 148.3 (3.)  
 Trefferlage: 0.72 mm links, 0.34 mm tief  
 Streuwert: 1.36, horizontal: 1.06, vertikal: 1.60

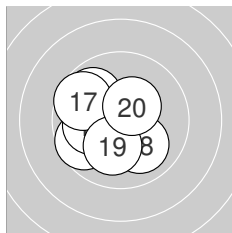

**Serie 2: 100.7 (97)**

|        |         |         |         |         |
|--------|---------|---------|---------|---------|
| 9.8 ↘  | 10.2* ↖ | 10.3* ↖ | 10.4* ↓ | 9.7 ↖   |
| 10.1 ↖ | 9.7 ↘   | 10.0 ↘  | 10.1 ↓  | 10.4* ↗ |

beste Teiler: 127.3 (14.), 138.6 (20.), 152.6 (13.)  
 Trefferlage: 1.04 mm links, 0.42 mm tief  
 Streuwert: 1.49, horizontal: 1.58, vertikal: 1.39

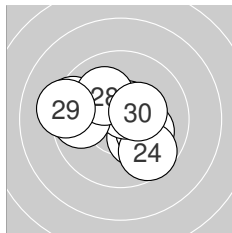

**Serie 3: 99.7 (96)**

|         |        |         |       |         |
|---------|--------|---------|-------|---------|
| 10.2* ↘ | 10.1 ↗ | 10.3* ↘ | 9.7 ↘ | 9.4 ↖   |
| 10.6* ↗ | 9.7 ↖  | 10.1 ↘  | 9.2 ↖ | 10.4* ↗ |

beste Teiler: 82.8 (26.), 145.0 (30.), 156.1 (23.)  
 Trefferlage: 0.60 mm links, 0.14 mm hoch  
 Streuwert: 1.91, horizontal: 2.35, vertikal: 1.34

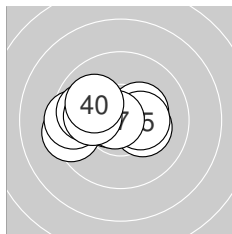

**Serie 4: 101.0 (97)**

|         |         |       |        |         |
|---------|---------|-------|--------|---------|
| 10.3* ↗ | 10.2* ↗ | 9.4 ↖ | 9.5 ↖  | 10.3* → |
| 10.6* ↖ | 10.8* ↖ | 9.8 ↖ | 10.1 ↖ | 10.0 ↘  |

beste Teiler: 43.1 (37.), 86.1 (36.), 153.0 (35.)  
 Trefferlage: 1.08 mm links, 0.15 mm hoch  
 Streuwert: 1.55, horizontal: 2.10, vertikal: 0.63



Ergebnis: **401.6** (386)  
 Serien: 100.6 102.3 101.2 97.5  
 Zähler: 27 12 1 0 0 0 0 0 0 0  
 Innenzehner: 17  
 Weitester: 667 (32.), 486 (34.), 379 (37.)  
 beste Teiler: 63.3 (12.), 95.0 (25.), 98.0 (40.)  
 Trefferlage: 0.47 mm links, 0.20 mm hoch  
 Streuwert: 1.81, horizontal: 2.11, vertikal: 1.43

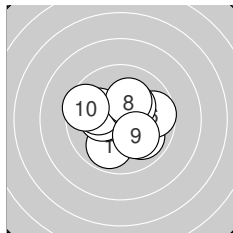
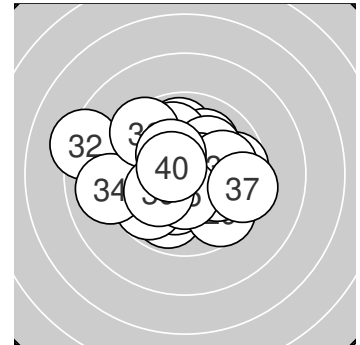

**Serie 1: 100.6 (96)**

|       |         |         |         |        |
|-------|---------|---------|---------|--------|
| 9.9 ↙ | 10.6* ← | 9.9 ↘   | 10.3* ← | 10.1 ← |
| 9.7 → | 10.3* ↗ | 10.2* ↗ | 10.1 ↘  | 9.5 ←  |

beste Teiler: 98.6 (2.), 167.7 (7.), 175.5 (4.)  
 Trefferlage: 0.07 mm links, 0.00 mm  
 Streuwert: 1.77, horizontal: 2.07, vertikal: 1.40

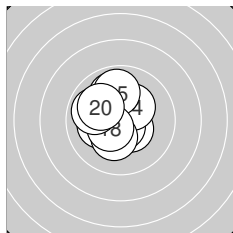

**Serie 2: 102.3 (98)**

|         |         |         |         |        |
|---------|---------|---------|---------|--------|
| 10.5* ↘ | 10.7* ↓ | 10.0 ↑  | 10.3* ↗ | 9.9 ↑  |
| 10.2* ← | 10.3* ↓ | 10.5* ↖ | 9.9 ←   | 10.0 ↘ |

beste Teiler: 63.3 (12.), 123.6 (18.), 123.9 (11.)  
 Trefferlage: 0.70 mm links, 0.41 mm hoch  
 Streuwert: 1.34, horizontal: 1.20, vertikal: 1.47

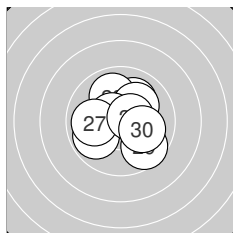

**Serie 3: 101.2 (98)**

|         |        |         |        |         |
|---------|--------|---------|--------|---------|
| 10.4* ↗ | 10.0 ↗ | 10.0 ↑  | 10.1 ↗ | 10.6* ↘ |
| 9.9 ↖   | 10.0 ← | 10.5* → | 9.6 ↘  | 10.1 →  |

beste Teiler: 95.0 (25.), 101.7 (28.), 138.9 (21.)  
 Trefferlage: 0.22 mm rechts, 0.31 mm hoch  
 Streuwert: 1.63, horizontal: 1.73, vertikal: 1.51

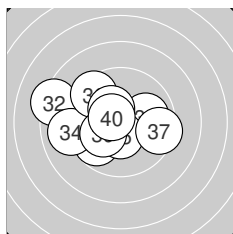

**Serie 4: 97.5 (94)**

|        |       |         |         |         |
|--------|-------|---------|---------|---------|
| 10.0 → | 8.3 ← | 9.8 ↖   | 9.0 ←   | 10.4* ↓ |
| 9.5 ↘  | 9.4 → | 10.3* ↘ | 10.2* ↖ | 10.6* ↘ |

beste Teiler: 98.0 (40.), 128.0 (35.), 154.8 (38.)  
 Trefferlage: 1.33 mm links, 0.07 mm hoch  
 Streuwert: 2.39, horizontal: 3.01, vertikal: 1.53



**Ergebnis: 414.1 (396)**  
**Serien: 103.0 103.3 103.6 104.2**  
**Zähler: 36 4 0 0 0 0 0 0 0 0**  
**Innenzehner: 31**  
**Weiteste: 402 (7.), 318 (14.), 300 (35.)**  
**beste Teiler: 18.8 (22.), 34.0 (38.), 49.1 (20.)**  
**Trefferlage: 0.33 mm rechts, 0.01 mm hoch**  
**Streuwert: 1.19, horizontal: 1.36, vertikal: 1.00**

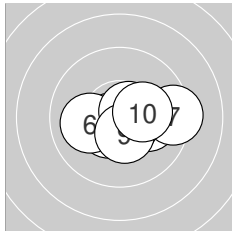
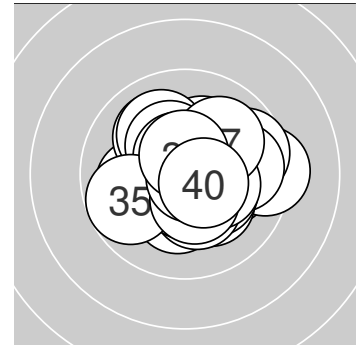

**Serie 1: 103.0 (99)**

|        |         |         |         |         |
|--------|---------|---------|---------|---------|
| 10.1 → | 10.5* ↙ | 10.6* → | 10.6* ↘ | 10.7* ↙ |
| 10.0 ← | 9.3 →   | 10.6* ↗ | 10.4* ↓ | 10.2* → |

**beste Teiler: 72.6 (5.), 80.9 (8.), 88.0 (3.)**  
**Trefferlage: 0.68 mm rechts, 0.27 mm tief**  
**Streuwert: 1.28, horizontal: 1.72, vertikal: 0.53**

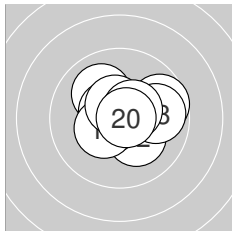

**Serie 2: 103.3 (98)**

|         |         |         |         |         |
|---------|---------|---------|---------|---------|
| 10.0 ↘  | 10.2* ↘ | 10.7* ↙ | 9.7 →   | 10.6* ↘ |
| 10.4* ↙ | 10.5* ↗ | 9.9 →   | 10.5* ↗ | 10.8* → |

**beste Teiler: 49.1 (20.), 74.3 (13.), 99.8 (15.)**  
**Trefferlage: 0.40 mm rechts, 0.29 mm hoch**  
**Streuwert: 1.29, horizontal: 1.56, vertikal: 0.94**

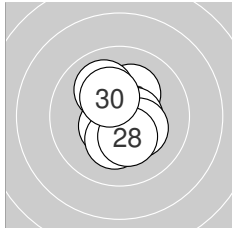

**Serie 3: 103.6 (100)**

|         |         |         |         |         |
|---------|---------|---------|---------|---------|
| 10.4* ↑ | 10.9* ↗ | 10.2* ↗ | 10.5* ↙ | 10.5* → |
| 10.3* ↘ | 10.2* ↓ | 10.3* ↓ | 10.0 ↘  | 10.3* ↗ |

**beste Teiler: 18.8 (22.), 102.1 (25.), 111.9 (24.)**  
**Trefferlage: 0.10 mm rechts, 0.17 mm hoch**  
**Streuwert: 1.16, horizontal: 0.87, vertikal: 1.38**

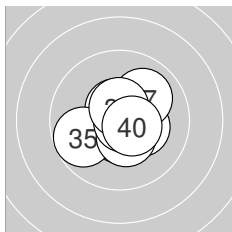

**Serie 4: 104.2 (99)**

|         |         |         |         |         |
|---------|---------|---------|---------|---------|
| 10.7* ↙ | 10.3* ↘ | 10.5* ↓ | 10.6* ↘ | 9.8 ↙   |
| 10.4* ↓ | 10.0 ↗  | 10.8* ↘ | 10.6* ↑ | 10.5* ↘ |

**beste Teiler: 34.0 (38.), 59.0 (31.), 92.8 (34.)**  
**Trefferlage: 0.13 mm rechts, 0.14 mm tief**  
**Streuwert: 1.13, horizontal: 1.25, vertikal: 0.99**



**Ergebnis: 413.8 (395)**  
**Serien: 103.7 104.2 103.0 102.9**  
**Zähler: 35 5 0 0 0 0 0 0 0 0**  
**Innenzehner: 32**  
**Weiteste: 382 (1.), 299 (28.), 279 (29.)**  
**beste Teiler: 18.6 (24.), 40.1 (36.), 56.0 (20.)**  
**Trefferlage: 0.24 mm links, 0.11 mm tief**  
**Streuwert: 1.19, horizontal: 1.13, vertikal: 1.26**

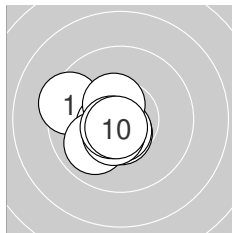
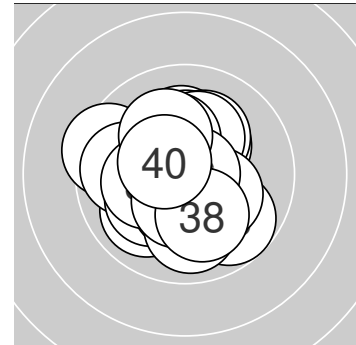

**Serie 1: 103.7 (98)**

|         |         |         |         |         |
|---------|---------|---------|---------|---------|
| 9.4 ↖   | 10.5* ↓ | 10.6* ↓ | 10.5* ← | 9.9 ↙   |
| 10.5* ↘ | 10.5* ↘ | 10.5* ↘ | 10.6* ↘ | 10.7* ↘ |

**beste Teiler: 67.1 (10.), 82.0 (3.), 87.8 (9.)**  
**Trefferlage: 0.88 mm links, 0.48 mm tief**  
**Streuwert: 1.01, horizontal: 1.10, vertikal: 0.91**

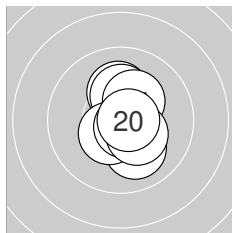

**Serie 2: 104.2 (100)**

|         |         |         |         |         |
|---------|---------|---------|---------|---------|
| 10.6* ↗ | 10.6* ↗ | 10.2* ↑ | 10.2* ↑ | 10.3* ↗ |
| 10.1 ↘  | 10.5* ↘ | 10.7* ↘ | 10.3* ↘ | 10.7* → |

**beste Teiler: 56.0 (20.), 57.1 (18.), 84.7 (12.)**  
**Trefferlage: 0.39 mm rechts, 0.23 mm hoch**  
**Streuwert: 1.03, horizontal: 0.60, vertikal: 1.33**

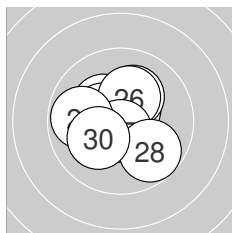

**Serie 3: 103.0 (98)**

|         |         |         |         |         |
|---------|---------|---------|---------|---------|
| 10.5* ↗ | 10.3* ↘ | 10.4* ↖ | 10.9* ← | 10.2* ↗ |
| 10.2* ↗ | 10.7* ↓ | 9.8 ↘   | 9.8 ←   | 10.2* ↘ |

**beste Teiler: 18.6 (24.), 70.0 (27.), 104.8 (21.)**  
**Trefferlage: 0.28 mm links, 0.21 mm hoch**  
**Streuwert: 1.36, horizontal: 1.44, vertikal: 1.26**

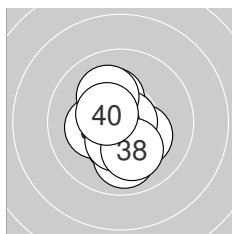

**Serie 4: 102.9 (99)**

|         |         |         |         |         |
|---------|---------|---------|---------|---------|
| 10.2* ↘ | 10.3* ↖ | 10.4* ↓ | 10.2* ← | 9.9 ↓   |
| 10.8* → | 10.4* ↓ | 10.1 ↘  | 10.1 ↖  | 10.5* ↖ |

**beste Teiler: 40.1 (36.), 114.3 (40.), 132.9 (37.)**  
**Trefferlage: 0.18 mm links, 0.43 mm tief**  
**Streuwert: 1.24, horizontal: 0.96, vertikal: 1.46**

