

**Ergebnis: 413.1 (398)**  
**Serien: 103.3 103.2 102.9 103.7**  
**Zähler: 38 2 0 0 0 0 0 0 0 0 0**  
**Innenzehner: 28**  
**Weiteste: 278 (29.), 261 (1.), 242 (3.)**  
**beste Teiler: 39.9 (36.), 42.9 (4.), 48.0 (34.)**  
**Trefferlage: 0.23 mm links, 0.37 mm hoch**  
**Streuwert: 1.17, horizontal: 1.28, vertikal: 1.04**

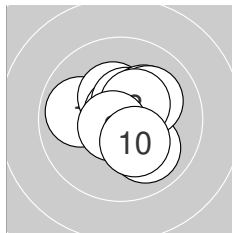
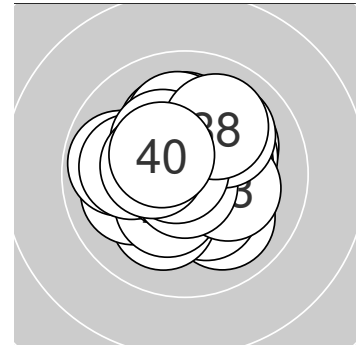

**Serie 1: 103.3 (99)**

9.9 ←	10.4* ↗	10.0 ↘	10.8* ↑	10.5* ↑
10.2* ↗	10.1 ↗	10.4* ↗	10.7* ↗	10.3* ↘

**beste Teiler: 42.9 (4.), 65.9 (9.), 112.8 (5.)**  
**Trefferlage: 0.33 mm rechts, 0.30 mm hoch**  
**Streuwert: 1.24, horizontal: 1.31, vertikal: 1.15**

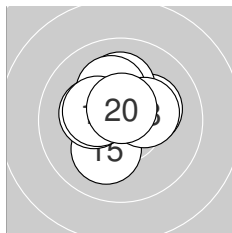

**Serie 2: 103.2 (100)**

10.6* ↗	10.5* ↗	10.2* →	10.1 ↑	10.1 ↓
10.3* ←	10.2* ↑	10.3* →	10.3* ←	10.6* ↑

**beste Teiler: 76.3 (20.), 82.3 (11.), 104.4 (12.)**  
**Trefferlage: 0.18 mm links, 0.51 mm hoch**  
**Streuwert: 1.14, horizontal: 1.15, vertikal: 1.13**

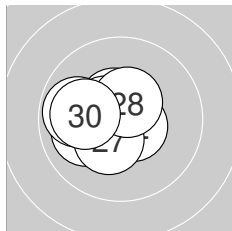

**Serie 3: 102.9 (99)**

10.1 ←	10.6* ↘	10.5* ↗	10.0 ←	10.5* ↗
10.5* ↗	10.4* ↗	10.5* ↑	9.8 ←	10.0 ←

**beste Teiler: 88.8 (22.), 109.5 (25.), 110.6 (23.)**  
**Trefferlage: 1.12 mm links, 0.03 mm tief**  
**Streuwert: 1.03, horizontal: 1.20, vertikal: 0.82**

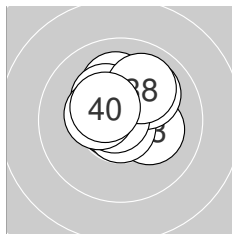

**Serie 4: 103.7 (100)**

10.1 ↑	10.7* ←	10.2* →	10.8* ↓	10.0 ↗
10.8* ←	10.3* ↗	10.0 ↗	10.4* ←	10.4* ↗

**beste Teiler: 39.9 (36.), 48.0 (34.), 52.7 (32.)**  
**Trefferlage: 0.02 mm rechts, 0.73 mm hoch**  
**Streuwert: 1.09, horizontal: 1.15, vertikal: 1.01**



**Ergebnis: 413.5 (397)**  
**Serien: 103.1 102.3 104.4 103.7**  
**Zähler: 38 1 1 0 0 0 0 0 0 0 0**  
**Innenzehner: 31**  
**Weiteste: 517 (16.), 370 (28.), 245 (10.)**  
**beste Teiler: 15.0 (30.), 55.1 (17.), 64.6 (39.)**  
**Trefferlage: 0.03 mm links, 0.38 mm tief**  
**Streuwert: 1.25, horizontal: 1.44, vertikal: 1.02**

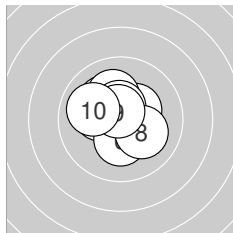
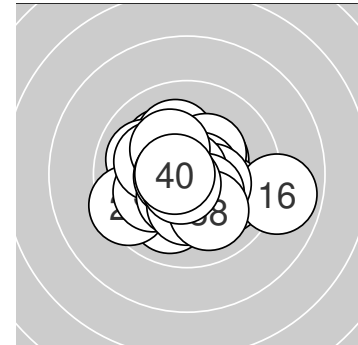

**Serie 1: 103.1 (100)**

10.3* ←	10.2* ↖	10.5* →	10.4* ↗	10.1 ↑
10.3* ↓	10.5* ↑	10.1 ↘	10.7* ↖	10.0 ↙

**beste Teiler: 70.2 (9.), 102.7 (7.), 119.5 (3.)**  
**Trefferlage: 0.22 mm links, 0.38 mm hoch**  
**Streuwert: 1.23, horizontal: 1.33, vertikal: 1.14**

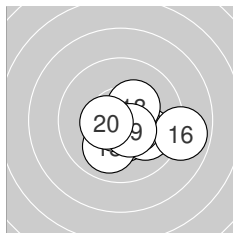

**Serie 2: 102.3 (98)**

10.4* ↓	10.0 ↘	10.6* ↓	10.4* ↘	10.0 ↓
8.9 →	10.7* ↗	10.3* ↗	10.5* ↘	10.5* ←

**beste Teiler: 55.1 (17.), 89.1 (13.), 115.3 (19.)**  
**Trefferlage: 0.79 mm rechts, 0.74 mm tief**  
**Streuwert: 1.41, horizontal: 1.80, vertikal: 0.87**

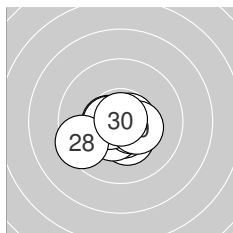

**Serie 3: 104.4 (99)**

10.5* ←	10.3* ↓	10.6* ↓	10.4* ↗	10.5* ↘
10.7* →	10.6* ←	9.5 ←	10.4* →	10.9* ↑

**beste Teiler: 15.0 (30.), 69.8 (26.), 89.7 (23.)**  
**Trefferlage: 0.20 mm links, 0.61 mm tief**  
**Streuwert: 1.06, horizontal: 1.34, vertikal: 0.66**

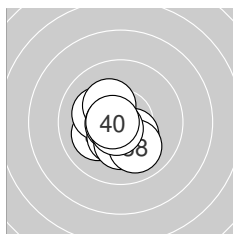

**Serie 4: 103.7 (100)**

10.1 ←	10.2* ↖	10.3* ↖	10.4* ↘	10.4* ↓
10.6* ←	10.3* ↓	10.0 ↘	10.7* ↗	10.7* ←

**beste Teiler: 64.6 (39.), 68.0 (40.), 76.1 (36.)**  
**Trefferlage: 0.49 mm links, 0.56 mm tief**  
**Streuwert: 1.05, horizontal: 1.03, vertikal: 1.07**



Ergebnis: **411.1** (391)  
 Serien: 101.6 102.4 104.7 102.4  
 Zähler: 31 9 0 0 0 0 0 0 0 0  
 Innenzehner: 29  
 Weitester: 321 (27.), 315 (20.), 313 (14.)  
 beste Teiler: 37.4 (23.), 42.5 (21.), 45.1 (28.)  
 Trefferlage: 0.20 mm links, 0.28 mm hoch  
 Streuwert: 1.34, horizontal: 1.10, vertikal: 1.54

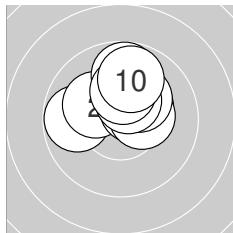
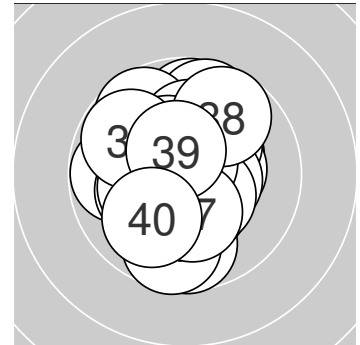

**Serie 1: 101.6 (97)**

9.8 ←	10.2* ↖	10.5* ↗	10.3* ↗	10.4* →
9.8 ↑	10.2* ↗	10.4* ↑	10.2* ↑	9.8 ↑

beste Teiler: 106.8 (3.), 137.2 (8.), 145.6 (5.)  
 Trefferlage: 0.18 mm rechts, 1.29 mm hoch  
 Streuwert: 1.21, horizontal: 1.41, vertikal: 0.97

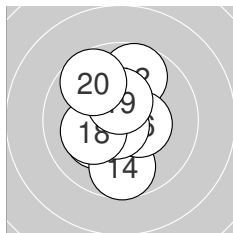

**Serie 2: 102.4 (97)**

10.6* ↑	9.7 ↑	10.2* ↖	9.7 ↓	10.7* ↖
10.4* →	10.8* ↖	10.2* ↖	10.4* ↑	9.7 ↖

beste Teiler: 49.0 (17.), 58.8 (15.), 98.1 (11.)  
 Trefferlage: 0.38 mm links, 0.24 mm hoch  
 Streuwert: 1.48, horizontal: 1.08, vertikal: 1.79

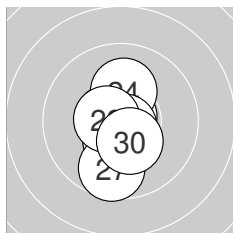

**Serie 3: 104.7 (99)**

10.8* ↓	10.6* ↖	10.8* ↗	10.1 ↑	10.5* ↓
10.4* ↓	9.7 ↓	10.8* ↓	10.6* ←	10.4* ↓

beste Teiler: 37.4 (23.), 42.5 (21.), 45.1 (28.)  
 Trefferlage: 0.15 mm links, 0.50 mm tief  
 Streuwert: 1.03, horizontal: 0.51, vertikal: 1.37

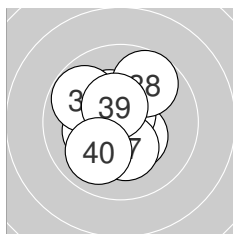

**Serie 4: 102.4 (98)**

10.2* ↖	10.4* ↘	10.4* ↗	10.4* ↖	10.7* ↑
9.8 ↖	10.3* ↓	9.7 ↗	10.5* ↖	10.0 ↖

beste Teiler: 52.6 (35.), 113.2 (39.), 133.0 (33.)  
 Trefferlage: 0.46 mm links, 0.08 mm hoch  
 Streuwert: 1.40, horizontal: 1.25, vertikal: 1.53



Ergebnis: **404.9** (386)  
 Serien: 100.7 100.1 100.4 103.7  
 Zähler: 27 12 1 0 0 0 0 0 0 0  
 Innenzehner: 20  
 Weitestе: 538 (25.), 447 (18.), 445 (9.)  
 beste Teiler: 22.4 (6.), 28.6 (17.), 46.2 (34.)  
 Trefferlage: 0.01 mm rechts, 0.34 mm tief  
 Streuwert: 1.71, horizontal: 1.95, vertikal: 1.44

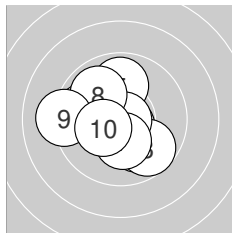
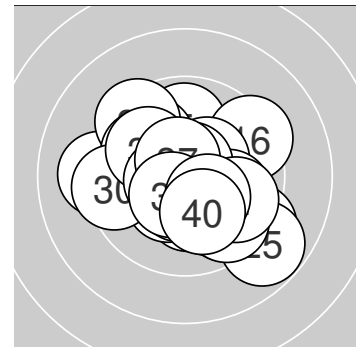

**Serie 1: 100.7 (95)**

10.0 ↘	10.7* ↘	9.7 ↘	9.8 ←	9.9 ↑
10.9* →	10.3* ↓	9.9 ↘	9.2 ←	10.3* ←

beste Teiler: 22.4 (6.), 70.2 (2.), 152.9 (10.)  
 Trefferlage: 0.62 mm links, 0.18 mm tief  
 Streuwert: 1.80, horizontal: 1.98, vertikal: 1.61

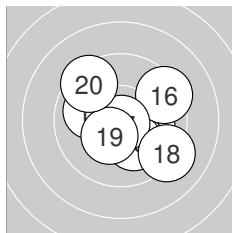

**Serie 2: 100.1 (97)**

10.6* ↗	10.1 →	10.0 ←	10.2* ↘	10.1 ↘
9.4 ↗	10.8* ↓	9.2 ↘	10.3* ↗	9.4 ↘

beste Teiler: 28.6 (17.), 94.7 (11.), 151.2 (19.)  
 Trefferlage: 0.49 mm rechts, 0.29 mm tief  
 Streuwert: 1.94, horizontal: 2.15, vertikal: 1.71

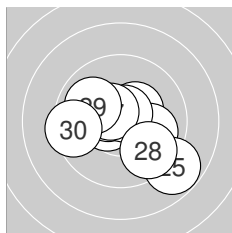

**Serie 3: 100.4 (95)**

10.5* ←	10.5* ↘	10.4* ↗	10.0 →	8.8 ↘
10.7* ↑	10.5* ↘	9.7 ↘	9.9 ←	9.4 ←

beste Teiler: 66.2 (26.), 104.5 (21.), 109.6 (27.)  
 Trefferlage: 0.12 mm rechts, 0.32 mm tief  
 Streuwert: 1.98, horizontal: 2.34, vertikal: 1.54

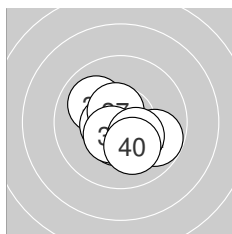

**Serie 4: 103.7 (99)**

9.8 →	10.0 ↘	10.5* ↓	10.8* ←	10.6* ←
10.5* ↓	10.6* ↗	10.5* ↗	10.3* ↘	10.1 ↘

beste Teiler: 46.2 (34.), 94.4 (37.), 100.4 (35.)  
 Trefferlage: 0.05 mm rechts, 0.55 mm tief  
 Streuwert: 1.18, horizontal: 1.30, vertikal: 1.03



**Ergebnis: 406.2 (387)**  
**Serien: 99.6 103.1 100.9 102.6**  
**Zähler: 27 13 0 0 0 0 0 0 0 0**  
**Innenzehner: 19**  
**Weiteste: 365 (8.), 348 (32.), 327 (10.)**  
**beste Teiler: 47.5 (23.), 69.8 (37.), 71.8 (35.)**  
**Trefferlage: 0.11 mm rechts, 0.19 mm hoch**  
**Streuwert: 1.57, horizontal: 1.76, vertikal: 1.34**

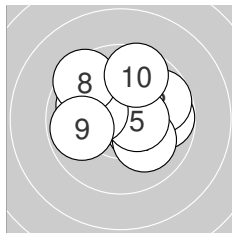
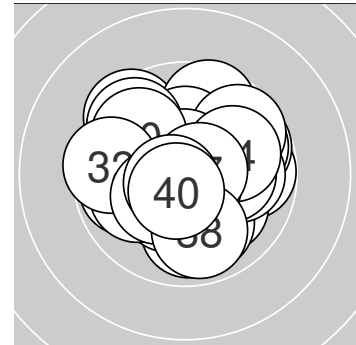

**Serie 1: 99.6 (95)**

10.4* ↘	9.8 →	9.7 →	10.1 ↘	10.5* →
10.0 ↖	10.2* ↖	9.5 ↖	9.8 ←	9.6 ↑

**beste Teiler: 116.0 (5.), 138.1 (1.), 180.5 (7.)**  
**Trefferlage: 0.16 mm rechts, 0.59 mm hoch**  
**Streuwert: 1.88, horizontal: 2.23, vertikal: 1.45**

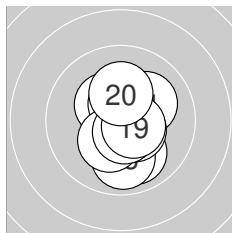

**Serie 2: 103.1 (99)**

10.1 ↗	10.0 ↓	9.9 ↓	10.4* ↖	10.5* ↑
10.3* ↙	10.5* ↘	10.6* ↓	10.6* ↗	10.2* ↑

**beste Teiler: 86.3 (18.), 99.3 (19.), 115.0 (15.)**  
**Trefferlage: 0.32 mm rechts, 0.29 mm tief**  
**Streuwert: 1.25, horizontal: 0.84, vertikal: 1.55**

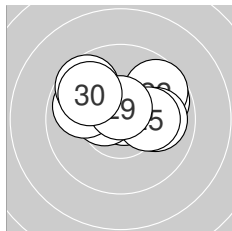

**Serie 3: 100.9 (95)**

9.8 ↗	9.7 ↗	10.8* ↗	10.0 →	10.2* →
10.5* ↖	9.9 ↖	9.6 ↖	10.6* ↑	9.8 ↖

**beste Teiler: 47.5 (23.), 80.0 (29.), 118.2 (26.)**  
**Trefferlage: 0.15 mm rechts, 0.97 mm hoch**  
**Streuwert: 1.60, horizontal: 2.11, vertikal: 0.81**

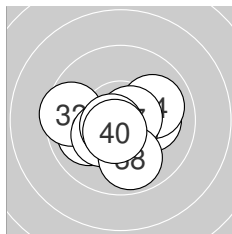

**Serie 4: 102.6 (98)**

10.0 ←	9.6 ←	10.1 →	10.0 →	10.7* ↘
10.3* ↙	10.7* →	9.9 ↓	10.7* ↙	10.6* ↙

**beste Teiler: 69.8 (37.), 71.8 (35.), 75.1 (39.)**  
**Trefferlage: 0.19 mm links, 0.48 mm tief**  
**Streuwert: 1.44, horizontal: 1.79, vertikal: 0.99**



Ergebnis: **376.5** (356)  
 Serien: 95.0 92.8 93.5 95.2  
 Zähler: 10 18 10 2 0 0 0 0 0 0  
 Innenzehner: 8  
 Weitester: 842 (25.), 770 (17.), 717 (10.)  
 beste Teiler: 68.0 (27.), 89.3 (40.), 112.2 (6.)  
 Trefferlage: 0.25 mm rechts, 0.93 mm tief  
 Streuwert: 2.99, horizontal: 3.64, vertikal: 2.16

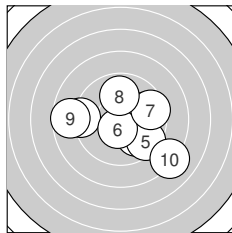
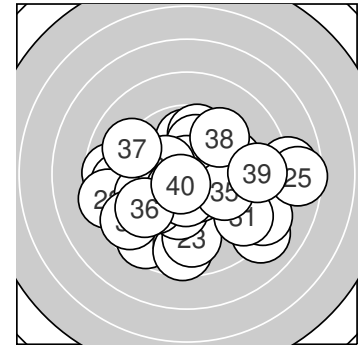

**Serie 1: 95.0 (90)**

9.8 →                      9.9 ↘                      10.1 →  
 10.5\* ↓                      9.5 →                      9.9 ↑  
 beste Teiler: 112.2 (6.), 203.1 (3.), 264.8 (2.)  
 Trefferlage: 0.77 mm rechts, 0.52 mm tief  
 Streuwert: 2.90, horizontal: 3.56, vertikal: 2.04

9.1 ←                      9.4 ↘  
 8.7 ←                      8.1 ↘

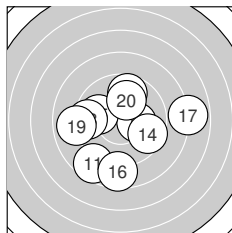

**Serie 2: 92.8 (87)**

8.6 ↙                      10.2\* →                      9.7 ↑  
 8.6 ↓                      7.9 →                      9.4 ←  
 beste Teiler: 183.5 (12.), 236.4 (20.), 259.2 (15.)  
 Trefferlage: 0.07 mm links, 0.64 mm tief  
 Streuwert: 3.34, horizontal: 3.78, vertikal: 2.83

9.6 ↘                      9.9 ←  
 8.9 ←                      10.0 ↑

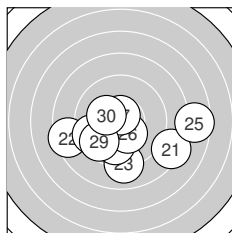

**Serie 3: 93.5 (89)**

8.3 ↘                      8.4 ←                      9.0 ↓  
 10.3\* ↘                      10.7\* ↑                      9.5 ←  
 beste Teiler: 68.0 (27.), 161.7 (26.), 175.6 (30.)  
 Trefferlage: 0.14 mm rechts, 1.65 mm tief  
 Streuwert: 3.22, horizontal: 4.22, vertikal: 1.73

9.8 ↓                      7.6 →  
 9.6 ↙                      10.3\* ↖

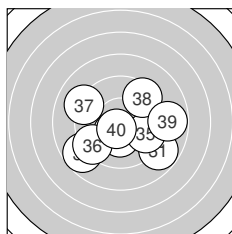

**Serie 4: 95.2 (90)**

8.8 ↘                      8.7 ↙                      10.4\* ↙                      10.3\* ↓                      9.7 ↘  
 9.3 ↙                      9.1 ↖                      9.5 ↗                      8.8 →                      10.6\* ↙  
 beste Teiler: 89.3 (40.), 142.8 (33.), 173.1 (34.)  
 Trefferlage: 0.18 mm rechts, 0.92 mm tief  
 Streuwert: 2.86, horizontal: 3.47, vertikal: 2.07



Ergebnis: **411.7** (396)  
 Serien: 102.8 103.6 102.4 102.9  
 Zähler: 36 4 0 0 0 0 0 0 0 0  
 Innenzehner: 30  
 Weitestе: 331 (33.), 313 (26.), 312 (28.)  
 beste Teiler: 10.0 (10.), 13.0 (17.), 43.9 (39.)  
 Trefferlage: 0.27 mm rechts, 0.11 mm tief  
 Streuwert: 1.28, horizontal: 1.45, vertikal: 1.09

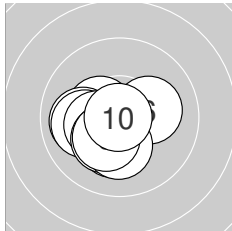
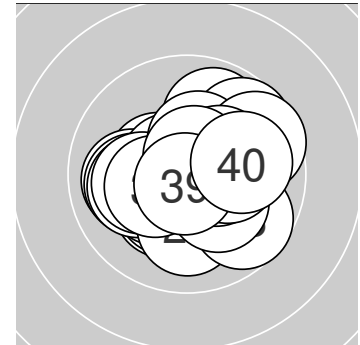

**Serie 1: 102.8 (100)**

10.4* ↖	10.0 ←	10.2* ↓	10.0 ←	10.3* ←
10.2* →	10.3* ↗	10.2* ↓	10.3* ↗	10.9* ←

beste Teiler: 10.0 (10.), 136.3 (1.), 153.3 (5.)  
 Trefferlage: 0.80 mm links, 0.66 mm tief  
 Streuwert: 1.08, horizontal: 1.25, vertikal: 0.88

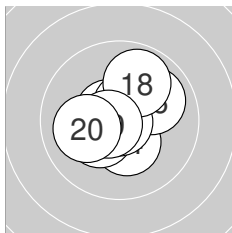

**Serie 2: 103.6 (99)**

10.4* ↗	10.6* ↖	10.5* ↗	10.3* ↓	10.3* ↗
10.0 ↗	10.9* ↘	9.9 ↗	10.6* ←	10.1 ←

beste Teiler: 13.0 (17.), 78.4 (19.), 83.2 (12.)  
 Trefferlage: 0.02 mm rechts, 0.27 mm hoch  
 Streuwert: 1.22, horizontal: 1.28, vertikal: 1.15

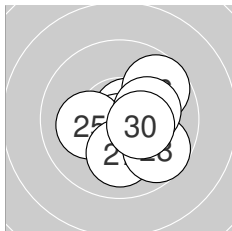

**Serie 3: 102.4 (98)**

10.4* ↓	10.3* →	10.7* ↗	10.7* ↓	10.2* ←
9.7 ↗	10.1 ↓	9.7 ↘	10.2* →	10.4* ↘

beste Teiler: 56.2 (24.), 67.9 (23.), 127.3 (21.)  
 Trefferlage: 0.79 mm rechts, 0.33 mm tief  
 Streuwert: 1.33, horizontal: 1.37, vertikal: 1.28

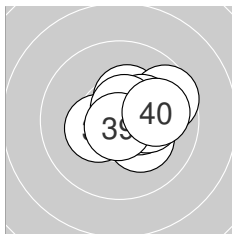

**Serie 4: 102.9 (99)**

10.2* ↘	10.4* ↗	9.6 →	10.3* ↗	10.4* →
10.2* →	10.4* ←	10.6* ↗	10.8* ↓	10.0 →

beste Teiler: 43.9 (39.), 83.0 (38.), 129.0 (35.)  
 Trefferlage: 1.06 mm rechts, 0.27 mm hoch  
 Streuwert: 1.09, horizontal: 1.28, vertikal: 0.86



**LG 40 ZR**

StandNr: 119

**Daxenbichler, Michael** #70418041

**Senioren\_3m**

Wertung

**StartNr: 163**

05.03.2023 14:36

SG\_Sportschützen\_Scheffau

Ergebnis: **0.0** (0)<sub>DNS</sub>  
Serien:  
Zähler: 0 0 0 0 0 0 0 0 0 0 0  
Innenzehner: 0  
Weiteste:  
~~beste Teiler~~  
Trefferlage: 0.00 mm , 0.00 mm  
Streuwert:

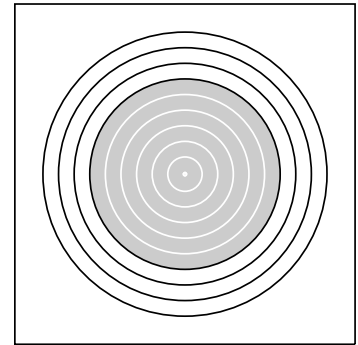



**Ergebnis: 418.7 (400)**  
**Serien: 104.3 104.5 105.0 104.9**  
**Zähler: 40 0 0 0 0 0 0 0 0 0 0**  
**Innenzehner: 34**  
**Weiteste: 242 (18.), 235 (32.), 214 (1.)**  
**beste Teiler: 26.4 (22.), 40.1 (30.), 40.8 (35.)**  
**Trefferlage: 0.33 mm rechts, 0.18 mm hoch**  
**Streuwert: 0.93, horizontal: 0.96, vertikal: 0.90**

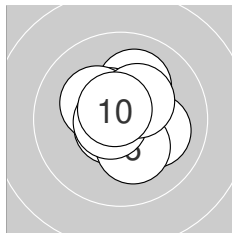
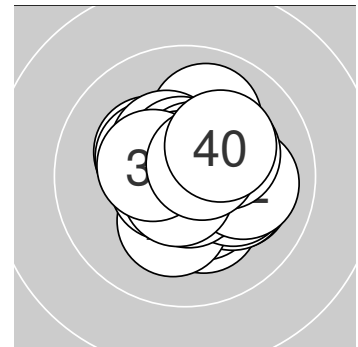

**Serie 1: 104.3 (100)**

10.1 ↗	10.1 →	10.6* ↗	10.7* ↙	10.5* ↘
10.2* ↓	10.3* ↘	10.7* ←	10.4* ↗	10.7* ↘

**beste Teiler: 63.0 (8.), 69.4 (10.), 73.8 (4.)**  
**Trefferlage: 0.12 mm rechts, 0.34 mm hoch**  
**Streuwert: 1.05, horizontal: 1.03, vertikal: 1.06**

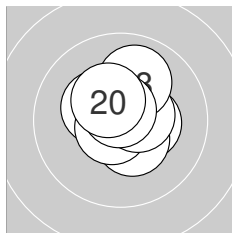

**Serie 2: 104.5 (100)**

10.4* ↗	10.4* →	10.7* ↘	10.4* ↓	10.3* ↘
10.7* ↙	10.5* →	10.0 ↗	10.7* ↑	10.4* ↘

**beste Teiler: 59.6 (19.), 61.7 (13.), 67.4 (16.)**  
**Trefferlage: 0.22 mm rechts, 0.43 mm hoch**  
**Streuwert: 0.95, horizontal: 0.88, vertikal: 1.01**

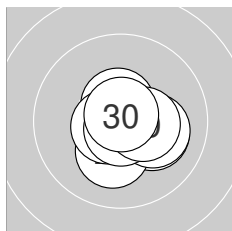

**Serie 3: 105.0 (100)**

10.6* ↓	10.8* ↘	10.1 →	10.2* ↓	10.6* ↑
10.1 →	10.6* ↙	10.8* ↓	10.4* →	10.8* ↑

**beste Teiler: 26.4 (22.), 40.1 (30.), 46.0 (28.)**  
**Trefferlage: 0.45 mm rechts, 0.35 mm tief**  
**Streuwert: 0.85, horizontal: 0.96, vertikal: 0.72**

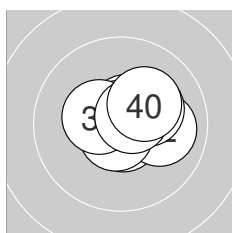

**Serie 4: 104.9 (100)**

10.7* ↓	10.0 →	10.7* ↗	10.6* ↗	10.8* ↗
10.7* ↙	10.2* ↗	10.4* ↖	10.6* ↗	10.2* ↗

**beste Teiler: 40.8 (35.), 62.6 (33.), 64.4 (36.)**  
**Trefferlage: 0.51 mm rechts, 0.31 mm hoch**  
**Streuwert: 0.86, horizontal: 1.05, vertikal: 0.62**



**Ergebnis: 410.8 (393)**  
**Serien:** 102.8 102.1 102.5 103.4  
**Zähler:** 33 7 0 0 0 0 0 0 0 0  
**Innenzehner:** 24  
**Weiteste:** 381 (8.), 322 (27.), 315 (31.)  
**beste Teiler:** 38.4 (1.), 44.3 (28.), 48.2 (4.)  
**Trefferlage:** 0.17 mm links, 0.01 mm hoch  
**Streuwert:** 1.37, horizontal: 1.21, vertikal: 1.52

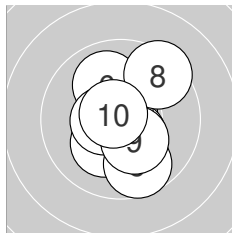
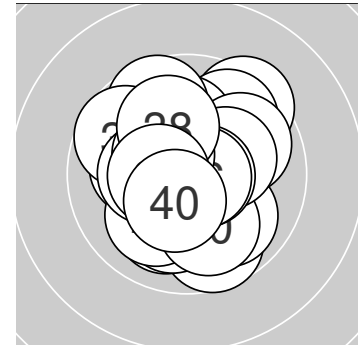

**Serie 1: 102.8 (98)**

10.8* ↗	10.2* ↘	10.4* ↘	10.8* ↑	9.7 ↓
10.0 ↘	10.5* ←	9.4 ↗	10.3* ↘	10.7* ↘

**beste Teiler:** 38.4 (1.), 48.2 (4.), 59.4 (10.)  
**Trefferlage:** 0.17 mm rechts, 0.06 mm tief  
**Streuwert:** 1.49, horizontal: 1.15, vertikal: 1.76

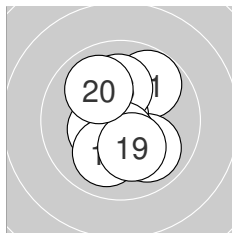

**Serie 2: 102.1 (98)**

9.8 ↗	9.9 ↘	10.5* ↓	10.7* ↘	10.4* ←
10.1 ↑	10.5* ↓	10.0 ↘	10.2* ↘	10.0 ↘

**beste Teiler:** 55.3 (14.), 101.0 (17.), 110.1 (13.)  
**Trefferlage:** 0.01 mm rechts, 0.15 mm tief  
**Streuwert:** 1.47, horizontal: 1.12, vertikal: 1.74

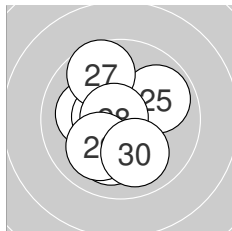

**Serie 3: 102.5 (98)**

10.1 ↓	10.6* ↗	10.1 ←	10.6* ↓	9.9 ↗
10.6* ←	9.7 ↘	10.8* ←	10.1 ↘	10.0 ↓

**beste Teiler:** 44.3 (28.), 82.9 (22.), 93.1 (24.)  
**Trefferlage:** 0.28 mm links, 0.14 mm tief  
**Streuwert:** 1.48, horizontal: 1.29, vertikal: 1.64

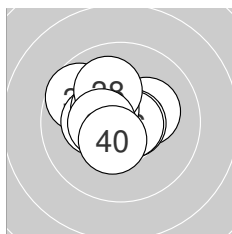

**Serie 4: 103.4 (99)**

9.7 ↘	10.2* ↗	10.4* ↘	10.3* ←	10.7* →
10.7* →	10.4* ↘	10.1 ↘	10.5* ←	10.4* ↘

**beste Teiler:** 59.6 (36.), 74.4 (35.), 124.1 (39.)  
**Trefferlage:** 0.62 mm links, 0.43 mm hoch  
**Streuwert:** 1.13, horizontal: 1.30, vertikal: 0.94



**Ergebnis: 408.3 (390)**  
**Serien:** 101.3 101.6 101.7 103.7  
**Zähler:** 30 10 0 0 0 0 0 0 0 0  
**Innenzehner:** 20  
**Weiteste:** 385 (5.), 382 (8.), 288 (3.)  
**beste Teiler:** 46.2 (10.), 55.7 (39.), 57.8 (16.)  
**Trefferlage:** 0.04 mm rechts, 0.15 mm tief  
**Streuwert:** 1.46, horizontal: 1.66, vertikal: 1.23

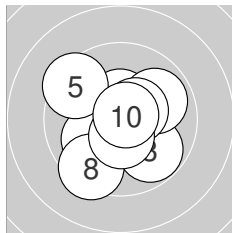
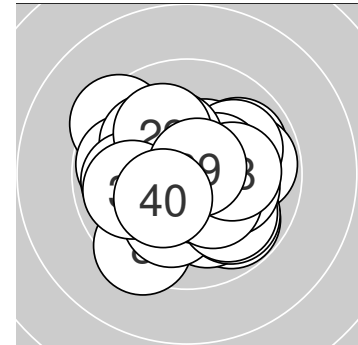

**Serie 1: 101.3 (96)**

10.5* ←	10.5* ↑	9.8 ↘	10.0 ↙	9.4 ↖
9.9 ↗	10.5* ↘	9.4 ↙	10.5* ↓	10.8* ↗

**beste Teiler:** 46.2 (10.), 114.1 (9.), 117.8 (7.)  
**Trefferlage:** 0.24 mm links, 0.23 mm tief  
**Streuwert:** 1.74, horizontal: 1.78, vertikal: 1.70

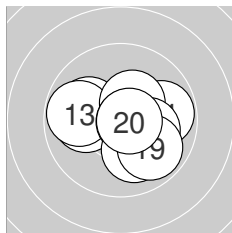

**Serie 2: 101.6 (97)**

10.0 ↖	10.0 ←	9.8 ←	9.8 →	10.4* ↗
10.7* →	10.1 ↘	10.2* ↘	9.9 ↘	10.7* →

**beste Teiler:** 57.8 (16.), 60.2 (20.), 142.5 (15.)  
**Trefferlage:** 0.21 mm rechts, 0.18 mm tief  
**Streuwert:** 1.58, horizontal: 1.97, vertikal: 1.05

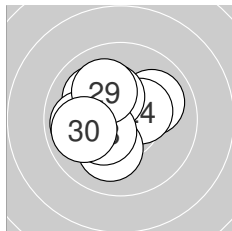

**Serie 3: 101.7 (98)**

10.0 ↗	10.5* ↑	10.1 ↖	10.4* →	9.9 ←
10.3* ↖	10.1 ↙	10.4* ↙	10.1 ↖	9.9 ←

**beste Teiler:** 105.9 (22.), 143.0 (24.), 145.4 (28.)  
**Trefferlage:** 0.72 mm links, 0.36 mm hoch  
**Streuwert:** 1.40, horizontal: 1.51, vertikal: 1.27

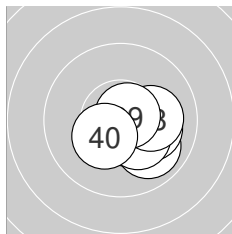

**Serie 4: 103.7 (99)**

10.5* ↘	9.9 ↘	10.6* →	10.6* →	10.6* ↘
10.1 →	10.3* ↘	10.1 →	10.7* ↗	10.3* ↙

**beste Teiler:** 55.7 (39.), 84.0 (35.), 87.4 (34.)  
**Trefferlage:** 0.94 mm rechts, 0.56 mm tief  
**Streuwert:** 0.81, horizontal: 0.94, vertikal: 0.66



**Ergebnis: 408.3 (389)**  
**Serien: 99.9 100.8 104.1 103.5**  
**Zähler: 29 11 0 0 0 0 0 0 0 0**  
**Innenzehner: 23**  
**Weiteste: 400 (3.), 353 (9.), 343 (33.)**  
**beste Teiler: 50.6 (29.), 56.0 (36.), 63.0 (24.)**  
**Trefferlage: 0.59 mm links, 0.28 mm tief**  
**Streuwert: 1.43, horizontal: 1.75, vertikal: 1.01**

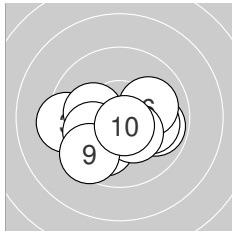
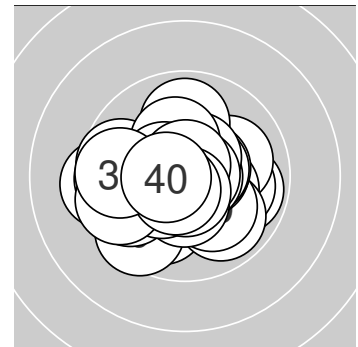

**Serie 1: 99.9 (97)**

9.8 →	10.0 →	9.4 ←	10.0 ↙	10.2* ←
10.0 →	10.0 ↙	10.3* ↘	9.5 ↙	10.7* ↘

**beste Teiler: 72.5 (10.), 155.8 (8.), 199.7 (5.)**  
**Trefferlage: 0.28 mm links, 0.82 mm tief**  
**Streuwert: 1.78, horizontal: 2.30, vertikal: 1.05**

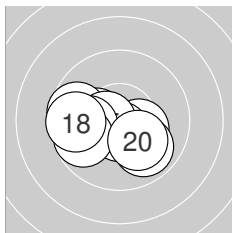

**Serie 2: 100.8 (96)**

10.3* ↘	10.3* ←	9.7 ←	10.6* ↓	10.5* ←
10.0 ←	9.8 ↙	9.6 ←	9.9 ↘	10.1 ↘

**beste Teiler: 85.0 (14.), 101.3 (15.), 159.3 (11.)**  
**Trefferlage: 0.97 mm links, 0.61 mm tief**  
**Streuwert: 1.52, horizontal: 1.99, vertikal: 0.80**

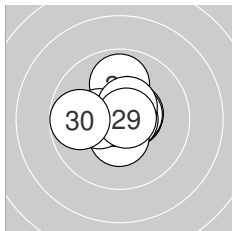

**Serie 3: 104.1 (98)**

10.6* →	10.5* →	10.6* →	10.7* →	10.4* ↓
9.9 ↑	10.3* ←	10.5* ↗	10.8* →	9.8 ←

**beste Teiler: 50.6 (29.), 63.0 (24.), 98.2 (21.)**  
**Trefferlage: 0.01 mm rechts, 0.32 mm hoch**  
**Streuwert: 1.15, horizontal: 1.29, vertikal: 0.98**

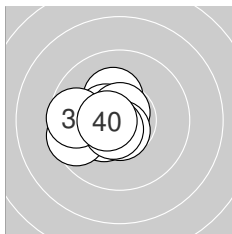

**Serie 4: 103.5 (98)**

10.2* ↑	10.4* ↙	9.6 ←	10.6* ↖	10.5* ↖
10.7* ↑	10.6* ↓	10.6* ↙	9.7 ←	10.6* ←

**beste Teiler: 56.0 (36.), 77.1 (37.), 82.0 (38.)**  
**Trefferlage: 1.12 mm links, 0.03 mm tief**  
**Streuwert: 1.04, horizontal: 1.18, vertikal: 0.86**



Ergebnis: **405.2** (382)  
 Serien: 99.9 101.5 101.4 102.4  
 Zähler: 22 18 0 0 0 0 0 0 0 0  
 Innenzehner: 17  
 Weitestе: 371 (15.), 361 (18.), 358 (1.)  
 beste Teiler: 2.2 (17.), 26.1 (21.), 36.0 (36.)  
 Trefferlage: 0.19 mm rechts, 0.02 mm hoch  
 Streuwert: 1.60, horizontal: 1.75, vertikal: 1.44

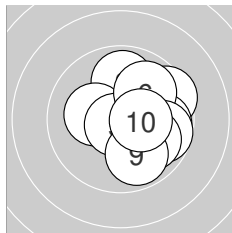
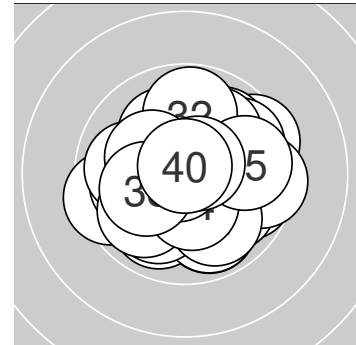

**Serie 1: 99.9 (93)**

9.5 ↗	9.9 ↑	10.2* ←	9.8 →	10.7* ↙
9.9 ↗	9.7 ↘	9.9 ↘	9.9 ↘	10.4* →

beste Teiler: 52.4 (5.), 144.2 (10.), 183.1 (3.)  
 Trefferlage: 1.34 mm rechts, 0.08 mm hoch  
 Streuwert: 1.59, horizontal: 1.60, vertikal: 1.58

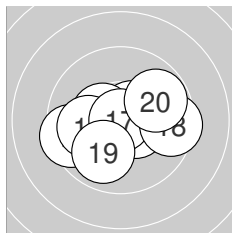

**Serie 2: 101.5 (96)**

10.5* ↘	10.4* ↙	10.6* ↗	10.4* ←	9.5 ←
10.0 ←	10.9* ↙	9.5 →	9.9 ↙	9.8 ↗

beste Teiler: 2.2 (17.), 97.4 (13.), 117.2 (11.)  
 Trefferlage: 0.14 mm links, 0.32 mm tief  
 Streuwert: 1.70, horizontal: 2.18, vertikal: 1.01

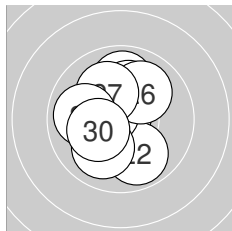

**Serie 3: 101.4 (97)**

10.8* ↑	9.9 ↘	9.9 ↑	10.1 ↑	10.5* ↘
10.0 ↗	10.1 ↘	9.9 ←	10.0 ↙	10.2* ↙

beste Teiler: 26.1 (21.), 101.0 (25.), 177.5 (30.)  
 Trefferlage: 0.40 mm links, 0.41 mm hoch  
 Streuwert: 1.52, horizontal: 1.27, vertikal: 1.74

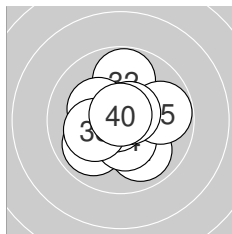

**Serie 4: 102.4 (96)**

9.9 ↘	9.8 ↑	9.9 ↙	10.4* ↘	9.8 →
10.8* ←	10.2* ↘	10.2* ←	10.6* ↗	10.8* ↑

beste Teiler: 36.0 (36.), 39.0 (40.), 79.5 (39.)  
 Trefferlage: 0.02 mm links, 0.08 mm tief  
 Streuwert: 1.48, horizontal: 1.50, vertikal: 1.46



Ergebnis: **414.7** (396)  
 Serien: 102.9 105.8 103.9 102.1  
 Zähler: 36 4 0 0 0 0 0 0 0 0  
 Innenzehner: 29  
 Weitester: 279 (33.), 271 (32.), 268 (29.)  
 beste Teiler: 23.0 (34.), 38.8 (26.), 50.1 (11.)  
 Trefferlage: 0.32 mm rechts, 0.00 mm  
 Streuwert: 1.14, horizontal: 1.07, vertikal: 1.21

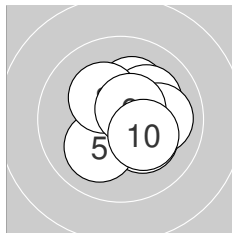
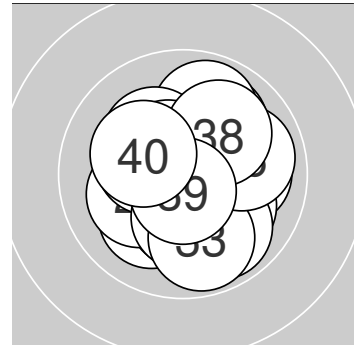

**Serie 1: 102.9 (100)**

10.6* ↘	10.2* ↘	10.2* ↗	10.5* ↘	10.1 ↗
10.1 ↗	10.0 →	10.3* ↘	10.6* ↗	10.3* ↘

beste Teiler: 89.8 (9.), 95.7 (1.), 119.9 (4.)  
 Trefferlage: 0.72 mm rechts, 0.02 mm tief  
 Streuwert: 1.18, horizontal: 1.16, vertikal: 1.20

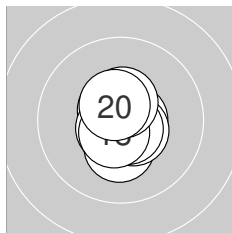

**Serie 2: 105.8 (100)**

10.8* ↘	10.7* →	10.6* ↘	10.3* ↓	10.5* ↘
10.7* ↘	10.6* ↗	10.6* ↗	10.5* ↑	10.5* ↗

beste Teiler: 50.1 (11.), 71.0 (16.), 74.0 (12.)  
 Trefferlage: 0.02 mm links, 0.11 mm tief  
 Streuwert: 0.72, horizontal: 0.53, vertikal: 0.87

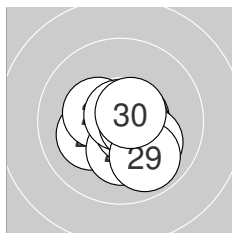

**Serie 3: 103.9 (99)**

10.1 ↖	10.3* ↖	10.6* →	10.2* ↓	10.7* ↘
10.8* ↑	10.6* →	10.1 ↘	9.9 ↘	10.6* ↗

beste Teiler: 38.8 (26.), 71.6 (25.), 81.6 (30.)  
 Trefferlage: 0.28 mm rechts, 0.51 mm tief  
 Streuwert: 1.08, horizontal: 1.15, vertikal: 0.99

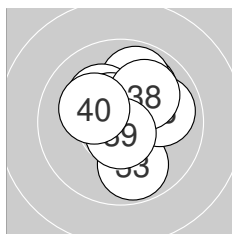

**Serie 4: 102.1 (97)**

10.0 ↗	9.9 ↑	9.8 ↓	10.9* ←	10.2* ↘
9.9 →	10.5* ↘	10.0 ↗	10.7* ↓	10.2* ↘

beste Teiler: 23.0 (34.), 71.0 (39.), 108.2 (37.)  
 Trefferlage: 0.33 mm rechts, 0.67 mm hoch  
 Streuwert: 1.41, horizontal: 1.30, vertikal: 1.52



**Ergebnis: 413.2 (393)**  
**Serien: 100.3 105.5 104.4 103.0**  
**Zähler: 33 7 0 0 0 0 0 0 0 0 0**  
**Innenzehner: 29**  
**Weiteste: 421 (7.), 420 (8.), 386 (6.)**  
**beste Teiler: 20.8 (26.), 24.2 (25.), 34.1 (17.)**  
**Trefferlage: 0.06 mm links, 0.23 mm hoch**  
**Streuwert: 1.33, horizontal: 1.68, vertikal: 0.84**

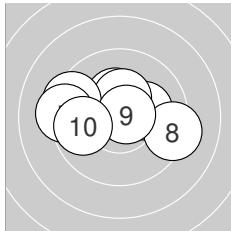
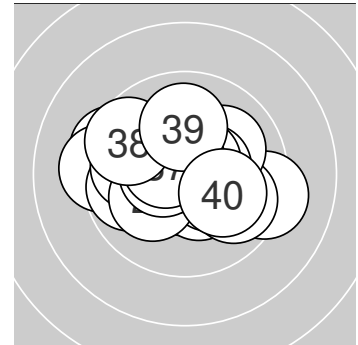

**Serie 1: 100.3 (96)**

10.5* ↖	10.3* ↑	10.4* →	10.2* →	10.4* ↑
9.4 ↖	9.3 ←	9.3 →	10.7* →	9.8 ←

**beste Teiler: 55.1 (9.), 113.1 (1.), 137.7 (3.)**  
**Trefferlage: 0.40 mm links, 0.46 mm hoch**  
**Streuwert: 1.92, horizontal: 2.58, vertikal: 0.85**

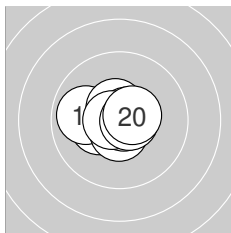

**Serie 2: 105.5 (99)**

10.3* ←	9.9 ←	10.7* ↗	10.6* ↓	10.6* ↑
10.7* ↗	10.8* ↘	10.7* ←	10.7* →	10.5* →

**beste Teiler: 34.1 (17.), 58.0 (18.), 61.2 (16.)**  
**Trefferlage: 0.20 mm links, 0.09 mm hoch**  
**Streuwert: 0.87, horizontal: 1.12, vertikal: 0.51**

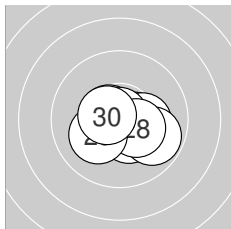

**Serie 3: 104.4 (99)**

10.5* →	10.6* ↖	10.4* ↘	10.2* →	10.9* ↖
10.9* ↑	9.8 ↘	10.4* ↘	10.1 ↖	10.6* ←

**beste Teiler: 20.8 (26.), 24.2 (25.), 90.3 (22.)**  
**Trefferlage: 0.36 mm rechts, 0.36 mm tief**  
**Streuwert: 1.04, horizontal: 1.32, vertikal: 0.65**

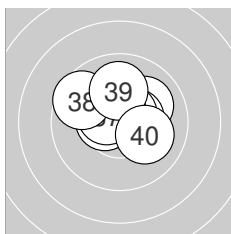

**Serie 4: 103.0 (99)**

10.0 ↗	10.5* →	10.6* ↗	10.7* ↖	10.5* ↑
10.5* ←	10.5* ↖	9.6 ↖	10.0 ↑	10.1 ↘

**beste Teiler: 60.4 (34.), 88.3 (33.), 111.3 (37.)**  
**Trefferlage: 0.03 mm links, 0.73 mm hoch**  
**Streuwert: 1.24, horizontal: 1.49, vertikal: 0.94**

