

Ergebnis: **412.6** (393)  
 Serien: 104.5 102.6 102.6 102.9  
 Zähler: 33 7 0 0 0 0 0 0 0 0  
 Innenzehner: 30  
 weiteste: 444 (17), 351 (22), 297 (34)  
 beste Teiler 15.5 (21.) 60.2 (5.) 62.6 (12.)  
 Trefferlage 0.16 mm rechts, 0.24 mm hoch  
 Streuwert 1.28, horizontal: 1.35, vertikal: 1.22

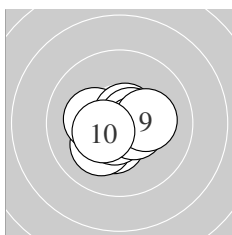

Serie 1:  
 10.4 \*                      10.2 \*                      10.6 \*                      10.2 \*                      10.7 \*  
 10.7 \*                      10.6 \*                      10.5 \*                      10.2 \*                      10.4 \*  
 beste Teiler 60.2 (5.) 73.2 (6.) 82.7 (3.)  
 Trefferlage 0.05 mm links, 0.27 mm tief  
 Streuwert 0.98, horizontal: 1.16, vertikal: 0.77

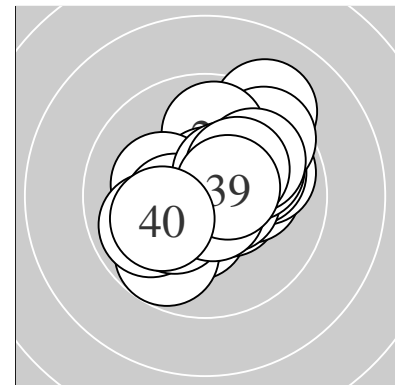
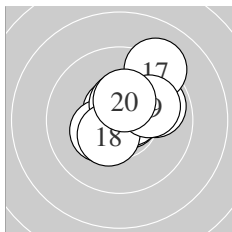

Serie 2:  
 10.6 \*                      10.7 \*                      10.3 \*                      9.9 ↗                      10.6 \*  
 10.5 \*                      9.2 ↗                      10.4 \*                      10.0 ↗                      10.4 \*  
 beste Teiler 62.6 (12.) 76.6 (11.) 85.0 (15.)  
 Trefferlage 0.64 mm rechts, 0.76 mm hoch  
 Streuwert 1.33, horizontal: 1.37, vertikal: 1.29

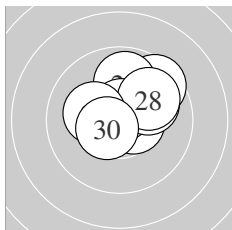

Serie 3:  
 10.9 \*                      9.5 ↗                      10.6 \*                      10.4 \*                      9.9 ↑  
 10.7 \*                      10.0 ↗                      9.9 ↗                      10.2 \*                      10.5 \*  
 beste Teiler 15.5 (21.) 73.1 (26.) 100.6 (23.)  
 Trefferlage 0.58 mm rechts, 0.98 mm hoch  
 Streuwert 1.23, horizontal: 1.37, vertikal: 1.07

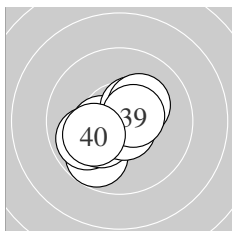

Serie 4:  
 10.6 \*                      10.4 \*                      10.4 \*                      9.8 ✓                      9.9 ↙  
 10.2 \*                      10.3 \*                      10.7 \*                      10.5 \*                      10.1 ↙  
 beste Teiler 65.5 (38.) 76.9 (31.) 104.7 (39.)  
 Trefferlage 0.51 mm links, 0.50 mm tief  
 Streuwert 1.22, horizontal: 1.33, vertikal: 1.09

Unterschrift des Schützen

Meyton Elektronik

Ergebnis: **418.2** (396)  
 Serien: 105.9 103.0 104.9 104.4  
 Zähler: 36 4 0 0 0 0 0 0 0 0  
 Innenzehner: 34  
 weiteste: 355 (35), 314 (14), 276 (12)  
 beste Teiler 7.2 (5.) 13.4 (7.) 13.9 (21.)  
 Trefferlage 0.10 mm links, 0.04 mm tief  
 Streuwert 1.07, horizontal: 1.34, vertikal: 0.72

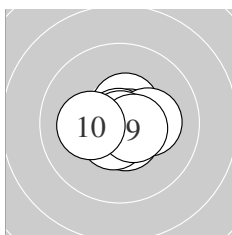
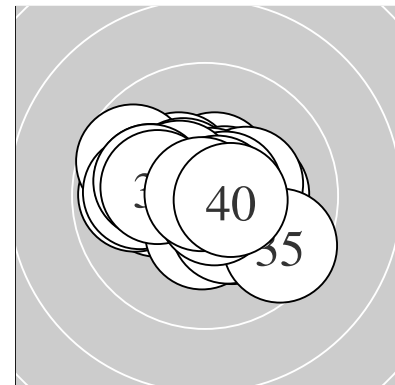

Serie 1:  
 10.7 \*                      10.6 \*                      10.5 \*                      10.7 \*                      10.9 \*  
 10.2 \*                      10.9 \*                      10.6 \*                      10.6 \*                      10.2 \*  
 beste Teiler 7.2 (5.) 13.4 (7.) 63.0 (4.)  
 Trefferlage 0.19 mm rechts, 0.18 mm tief  
 Streuwert 0.79, horizontal: 0.96, vertikal: 0.56

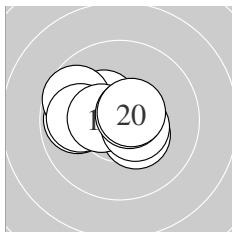

Serie 2:  
 10.5 \*                      9.8 ←                      10.4 \*                      9.7 ↖                      9.9 ←  
 10.4 \*                      10.5 \*                      10.5 \*                      10.7 \*                      10.6 \*  
 beste Teiler 75.2 (19.) 91.8 (20.) 112.8 (18.)  
 Trefferlage 0.79 mm links, 0.28 mm hoch  
 Streuwert 1.23, horizontal: 1.60, vertikal: 0.68

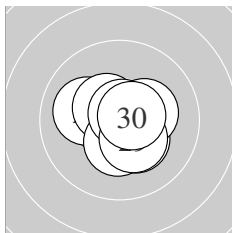

Serie 3:  
 10.9 \*                      10.3 \*                      10.6 \*                      10.1 ↖                      10.5 \*  
 10.4 \*                      10.3 \*                      10.8 \*                      10.4 \*                      10.6 \*  
 beste Teiler 13.9 (21.) 47.1 (28.) 84.1 (30.)  
 Trefferlage 0.06 mm rechts, 0.14 mm tief  
 Streuwert 0.99, horizontal: 1.12, vertikal: 0.84

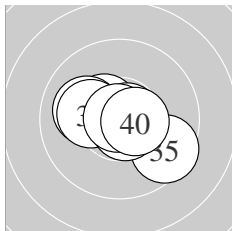

Serie 4:  
 10.5 \*                      10.1 ↖                      10.6 \*                      10.8 \*                      9.5 ↘  
 10.2 \*                      10.6 \*                      10.7 \*                      10.9 \*                      10.5 \*  
 beste Teiler 15.6 (39.) 49.7 (34.) 61.4 (38.)  
 Trefferlage 0.13 mm rechts, 0.12 mm tief  
 Streuwert 1.20, horizontal: 1.52, vertikal: 0.75

Unterschrift des Schützen

Ergebnis: **403.6** (389)  
 Serien: 101.1 100.2 102.1 100.2  
 Zähler: 30 9 1 0 0 0 0 0 0  
 Innenzehner: 23  
 weiteste: 548 (36), 475 (13), 468 (17)  
 beste Teiler 23.0 (37.) 50.0 (28.) 58.8 (39.)  
 Trefferlage 0.68 mm links, 0.61 mm hoch  
 Streuwert 1.68, horizontal: 1.94, vertikal: 1.36

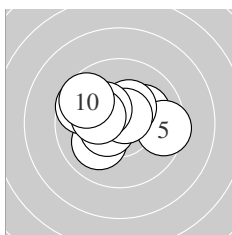
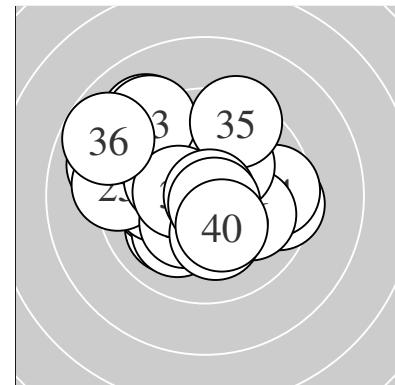

Serie 1:  
 10.1 ↗ 10.1 ↙ 9.6 ↖ 10.5 \* 9.5 →  
 10.4 \* 10.7 \* 10.3 \* 10.2 \* 9.7 ↖  
 beste Teiler 72.4 (7.) 109.6 (4.) 148.3 (6.)  
 Trefferlage 0.46 mm links, 0.52 mm hoch  
 Streuwert 1.65, horizontal: 2.09, vertikal: 1.03

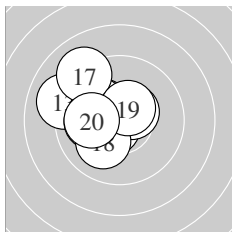

Serie 2:  
 10.2 \* 10.6 \* 9.1 ↖ 10.5 \* 10.0 ←  
 10.1 ↖ 9.1 ↖ 10.1 ↗ 10.5 \* 10.0 ←  
 beste Teiler 82.7 (12.) 118.7 (14.) 118.7 (19.)  
 Trefferlage 1.53 mm links, 0.67 mm hoch  
 Streuwert 1.54, horizontal: 1.63, vertikal: 1.45

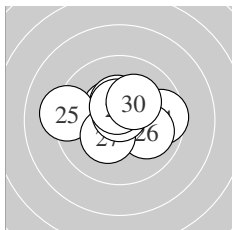

Serie 3:  
 10.5 \* 10.4 \* 10.6 \* 9.6 → 9.2 ←  
 10.0 → 10.3 \* 10.8 \* 10.5 \* 10.2 \*  
 beste Teiler 50.0 (28.) 77.8 (23.) 111.0 (29.)  
 Trefferlage 0.09 mm rechts, 0.36 mm hoch  
 Streuwert 1.59, horizontal: 2.04, vertikal: 0.95

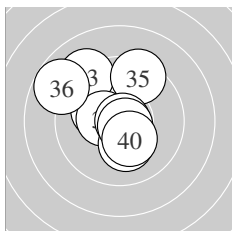

Serie 4:  
 10.2 \* 10.2 \* 9.1 ↖ 10.4 \* 9.4 ↗  
 8.8 ↖ 10.9 \* 10.2 \* 10.7 \* 10.3 \*  
 beste Teiler 23.0 (37.) 58.8 (39.) 130.5 (34.)  
 Trefferlage 0.82 mm links, 0.88 mm hoch  
 Streuwert 1.93, horizontal: 1.90, vertikal: 1.96

Unterschrift des Schützen

Meyton Elektronik

Ergebnis: **413.8** (396)  
 Serien: 104.6 102.8 102.7 103.7  
 Zähler: 36 4 0 0 0 0 0 0 0 0  
 Innenzehner: 32  
 weiteste: 436 (26), 296 (13), 267 (22)  
 beste Teiler 26.4 (5.) 39.3 (36.) 56.6 (23.)  
 Trefferlage 0.04 mm rechts, 0.19 mm tief  
 Streuwert 1.21, horizontal: 1.48, vertikal: 0.87

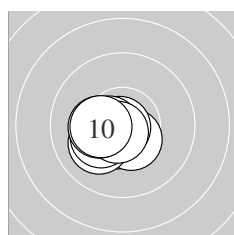
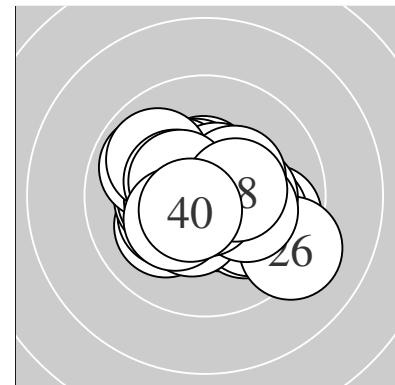

Serie 1:  
 10.5 \*                      10.5 \*                      10.6 \*                      10.1 ✓                      10.8 \*  
 10.6 \*                      10.2 \*                      10.7 \*                      10.3 \*                      10.3 \*  
 beste Teiler 26.4 (5.) 63.6 (8.) 93.1 (3.)  
 Trefferlage 0.87 mm links, 0.56 mm tief  
 Streuwert 0.63, horizontal: 0.78, vertikal: 0.44

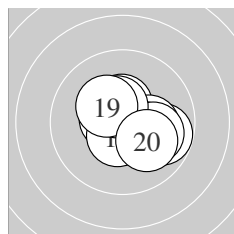

Serie 2:  
 10.5 \*                      10.6 \*                      9.8 ↘                      10.2 \*                      10.3 \*  
 10.5 \*                      10.0 ↘                      10.5 \*                      10.3 \*                      10.1 ↘  
 beste Teiler 92.8 (12.) 104.7 (16.) 117.9 (18.)  
 Trefferlage 0.71 mm rechts, 0.12 mm tief  
 Streuwert 1.23, horizontal: 1.44, vertikal: 0.98

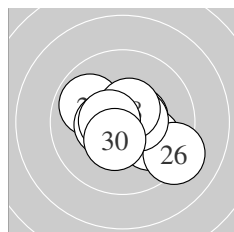

Serie 3:  
 10.5 \*                      9.9 ↖                      10.7 \*                      10.4 \*                      10.0 ↘  
 9.2 ↘                      10.5 \*                      10.5 \*                      10.6 \*                      10.4 \*  
 beste Teiler 56.6 (23.) 96.4 (29.) 105.5 (28.)  
 Trefferlage 0.35 mm rechts, 0.19 mm tief  
 Streuwert 1.46, horizontal: 1.76, vertikal: 1.09

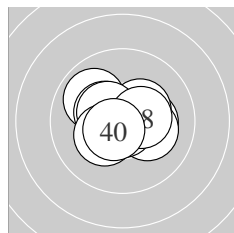

Serie 4:  
 9.9 ↖                      10.4 \*                      10.2 \*                      10.4 \*                      10.2 \*  
 10.8 \*                      10.5 \*                      10.4 \*                      10.3 \*                      10.6 \*  
 beste Teiler 39.3 (36.) 89.1 (40.) 125.8 (37.)  
 Trefferlage 0.01 mm links, 0.12 mm hoch  
 Streuwert 1.18, horizontal: 1.45, vertikal: 0.80

Unterschrift des Schützen

Ergebnis: **415.0** (396)  
 Serien: 102.9 103.6 104.0 104.5  
 Zähler: 36 4 0 0 0 0 0 0 0 0  
 Innenzehner: 33  
 weiteste: 447 (9), 276 (13), 266 (11)  
 beste Teiler 37.0 (23.) 63.3 (31.) 63.4 (16.)  
 Trefferlage 0.46 mm links, 0.27 mm tief  
 Streuwert 1.10, horizontal: 1.10, vertikal: 1.09

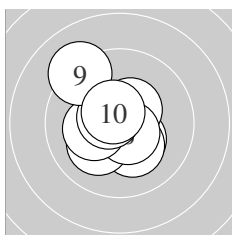
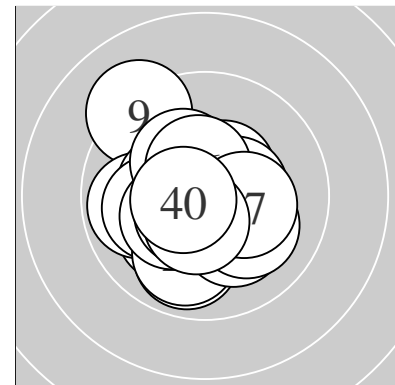

Serie 1:  
 10.6 \*                      10.3 \*                      10.2 \*                      10.1 ↙                      10.5 \*  
 10.6 \*                      10.2 \*                      10.6 \*                      9.2 ↘                      10.6 \*  
 beste Teiler 82.8 (1.) 88.5 (8.) 89.2 (6.)  
 Trefferlage 0.34 mm links, 0.10 mm hoch  
 Streuwert 1.43, horizontal: 1.33, vertikal: 1.51

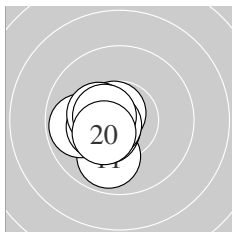

Serie 2:  
 9.9 ↓                      10.6 \*                      9.8 ←                      10.5 \*                      10.3 \*  
 10.7 \*                      10.6 \*                      10.3 \*                      10.5 \*                      10.4 \*  
 beste Teiler 63.4 (16.) 77.8 (17.) 97.0 (12.)  
 Trefferlage 1.14 mm links, 0.48 mm tief  
 Streuwert 0.78, horizontal: 0.66, vertikal: 0.88

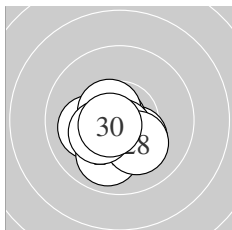

Serie 3:  
 10.6 \*                      10.3 \*                      10.8 \*                      10.1 ←                      10.6 \*  
 10.6 \*                      9.9 ↓                      10.2 \*                      10.3 \*                      10.6 \*  
 beste Teiler 37.0 (23.) 76.4 (30.) 77.7 (26.)  
 Trefferlage 0.43 mm links, 0.67 mm tief  
 Streuwert 0.97, horizontal: 1.03, vertikal: 0.91

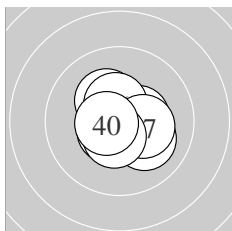

Serie 4:  
 10.7 \*                      10.6 \*                      10.1 ↘                      10.4 \*                      10.3 \*  
 10.5 \*                      10.3 \*                      10.5 \*                      10.5 \*                      10.6 \*  
 beste Teiler 63.3 (31.) 88.4 (32.) 93.5 (40.)  
 Trefferlage 0.05 mm rechts, 0.05 mm tief  
 Streuwert 1.00, horizontal: 1.08, vertikal: 0.91

Unterschrift des Schützen

Meyton Elektronik

Ergebnis: **414.5** (394)  
 Serien: 103.4 102.3 105.5 103.3  
 Zähler: 34 6 0 0 0 0 0 0 0 0  
 Innenzehner: 28  
 weiteste: 359 (34), 332 (36), 318 (12)  
 beste Teiler 8.0 (9.) 33.9 (30.) 35.6 (6.)  
 Trefferlage 0.31 mm rechts, 0.05 mm hoch  
 Streuwert 1.21, horizontal: 1.44, vertikal: 0.92

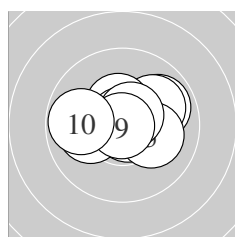
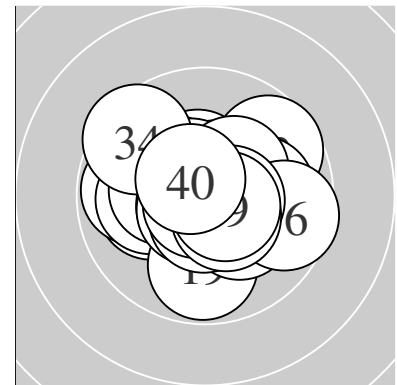

Serie 1:  
 9.9 ↗ 10.0 ↗ 10.8 \* 10.4 \* 10.1 ↗  
 10.8 \* 10.1 ← 10.6 \* 10.9 \* 9.8 ←  
 beste Teiler 8.0 (9.) 35.6 (6.) 45.0 (3.)  
 Trefferlage 0.18 mm rechts, 0.36 mm hoch  
 Streuwert 1.32, horizontal: 1.72, vertikal: 0.71

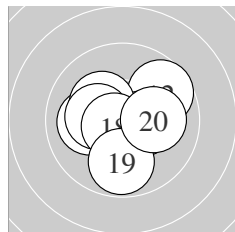

Serie 2:  
 10.4 \* 9.7 ↗ 10.5 \* 10.5 \* 10.1 ←  
 10.2 \* 10.3 \* 10.7 \* 9.8 ↓ 10.1 →  
 beste Teiler 69.6 (18.) 102.4 (14.) 123.9 (13.)  
 Trefferlage 0.07 mm rechts, 0.15 mm tief  
 Streuwert 1.45, horizontal: 1.64, vertikal: 1.23

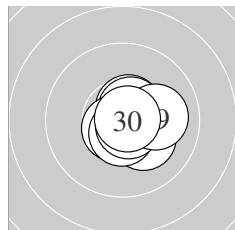

Serie 3:  
 10.7 \* 10.6 \* 10.6 \* 10.6 \* 10.2 \*  
 10.6 \* 10.6 \* 10.7 \* 10.1 → 10.8 \*  
 beste Teiler 33.9 (30.) 55.8 (28.) 72.6 (21.)  
 Trefferlage 0.57 mm rechts, 0.23 mm tief  
 Streuwert 0.72, horizontal: 0.76, vertikal: 0.66

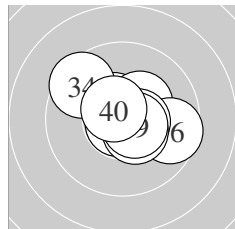

Serie 4:  
 10.4 \* 10.5 \* 10.8 \* 9.5 ↘ 10.3 \*  
 9.6 → 10.5 \* 10.5 \* 10.6 \* 10.6 \*  
 beste Teiler 42.4 (33.) 91.4 (40.) 93.0 (39.)  
 Trefferlage 0.41 mm rechts, 0.23 mm hoch  
 Streuwert 1.32, horizontal: 1.59, vertikal: 0.99

Unterschrift des Schützen

Ergebnis: **419.9** (400)  
 Serien: 105.3 105.9 104.1 104.6  
 Zähler: 40 0 0 0 0 0 0 0 0 0  
 Innenzehner: 36  
 weiteste: 246 (34), 238 (30), 206 (29)  
 beste Teiler 32.7 (18.) 43.2 (35.) 43.4 (15.)  
 Trefferlage 0.17 mm links, 0.26 mm tief  
 Streuwert 0.87, horizontal: 1.05, vertikal: 0.64

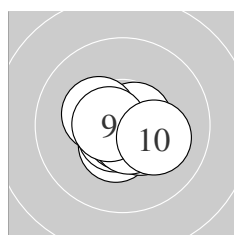
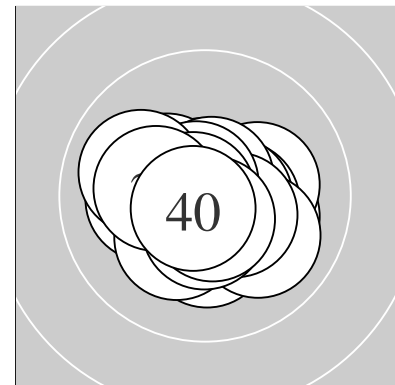

Serie 1:  
 10.5 \*                      10.4 \*                      10.7 \*                      10.7 \*                      10.8 \*  
 10.6 \*                      10.6 \*                      10.3 \*                      10.6 \*                      10.1 ↘  
 beste Teiler 45.0 (5.) 55.1 (3.) 71.8 (4.)  
 Trefferlage 0.13 mm rechts, 0.37 mm tief  
 Streuwert 0.79, horizontal: 0.96, vertikal: 0.56

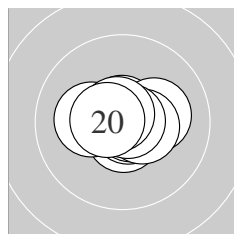

Serie 2:  
 10.6 \*                      10.7 \*                      10.2 \*                      10.2 \*                      10.8 \*  
 10.8 \*                      10.5 \*                      10.8 \*                      10.7 \*                      10.6 \*  
 beste Teiler 32.7 (18.) 43.4 (15.) 50.6 (16.)  
 Trefferlage 0.10 mm rechts, 0.03 mm hoch  
 Streuwert 0.79, horizontal: 1.04, vertikal: 0.41

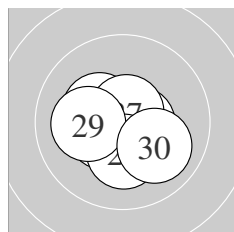

Serie 3:  
 10.3 \*                      10.6 \*                      10.6 \*                      10.6 \*                      10.5 \*  
 10.5 \*                      10.7 \*                      10.2 \*                      10.1 ←                      10.0 ↘  
 beste Teiler 64.2 (27.) 77.3 (24.) 83.9 (22.)  
 Trefferlage 0.37 mm links, 0.36 mm tief  
 Streuwert 1.00, horizontal: 1.17, vertikal: 0.78

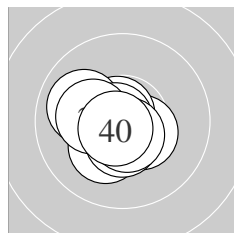

Serie 4:  
 10.4 \*                      10.5 \*                      10.7 \*                      10.0 ↖                      10.8 \*  
 10.2 \*                      10.5 \*                      10.6 \*                      10.2 \*                      10.7 \*  
 beste Teiler 43.2 (35.) 54.4 (33.) 62.2 (40.)  
 Trefferlage 0.58 mm links, 0.35 mm tief  
 Streuwert 0.87, horizontal: 0.98, vertikal: 0.74

Unterschrift des Schützen

Meyton Elektronik

Ergebnis: **419.4** (400)  
 Serien: 105.1 105.1 104.8 104.4  
 Zähler: 40 0 0 0 0 0 0 0 0 0  
 Innenzehner: 38  
 weiteste: 247 (25), 245 (38), 186 (12)  
 beste Teiler 25.8 (32.) 35.8 (16.) 38.0 (7.)  
 Trefferlage 0.31 mm links, 0.00 mm  
 Streuwert 0.90, horizontal: 1.03, vertikal: 0.74

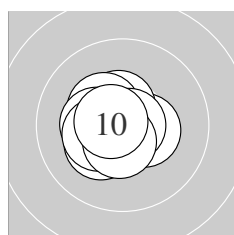
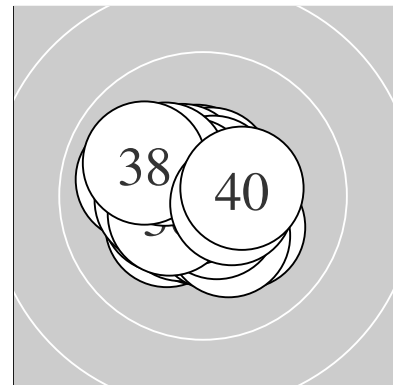

Serie 1:  
 10.3 \*                      10.4 \*                      10.5 \*                      10.8 \*                      10.4 \*  
 10.3 \*                      10.8 \*                      10.3 \*                      10.6 \*                      10.7 \*  
 beste Teiler 38.0 (7.) 49.4 (4.) 74.3 (10.)  
 Trefferlage 0.53 mm links, 0.09 mm tief  
 Streuwert 0.82, horizontal: 0.90, vertikal: 0.72

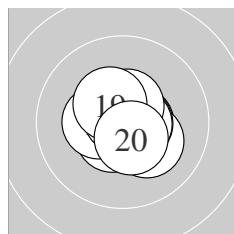

Serie 2:  
 10.6 \*                      10.2 \*                      10.5 \*                      10.6 \*                      10.4 \*  
 10.8 \*                      10.6 \*                      10.5 \*                      10.4 \*                      10.5 \*  
 beste Teiler 35.8 (16.) 76.9 (17.) 81.3 (14.)  
 Trefferlage 0.17 mm rechts, 0.07 mm tief  
 Streuwert 0.83, horizontal: 0.90, vertikal: 0.76

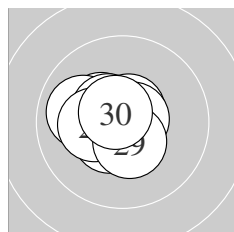

Serie 3:  
 10.6 \*                      10.7 \*                      10.7 \*                      10.3 \*                      10.0 ↖  
 10.5 \*                      10.5 \*                      10.3 \*                      10.5 \*                      10.7 \*  
 beste Teiler 61.9 (23.) 70.9 (22.) 73.6 (30.)  
 Trefferlage 0.66 mm links, 0.18 mm hoch  
 Streuwert 0.85, horizontal: 0.97, vertikal: 0.70

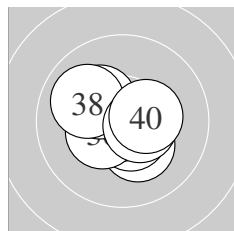

Serie 4:  
 10.3 \*                      10.9 \*                      10.6 \*                      10.8 \*                      10.3 \*  
 10.4 \*                      10.2 \*                      10.0 ↖                      10.5 \*                      10.4 \*  
 beste Teiler 25.8 (32.) 45.2 (34.) 93.4 (33.)  
 Trefferlage 0.24 mm links, 0.02 mm tief  
 Streuwert 1.07, horizontal: 1.25, vertikal: 0.87

Unterschrift des Schützen

Meyton Elektronik



Ergebnis: **412.2** (392)  
 Serien: 102.1 102.0 104.0 104.1  
 Zähler: 32 8 0 0 0 0 0 0 0 0  
 Innenzehner: 30  
 weiteste: 428 (11), 363 (9), 333 (14)  
 beste Teiler 12.7 (16.) 39.0 (3.) 39.6 (38.)  
 Trefferlage 0.07 mm rechts, 0.30 mm tief  
 Streuwert 1.34, horizontal: 1.65, vertikal: 0.95

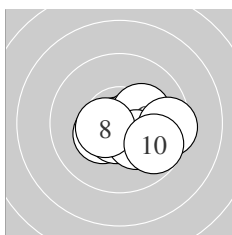
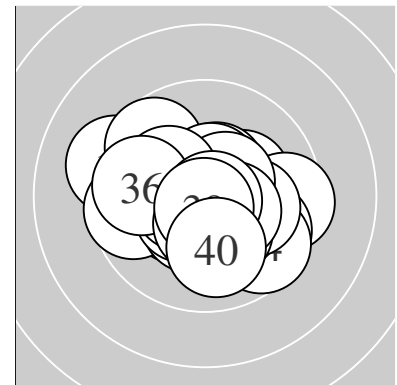

Serie 1:  
 10.4 \*                      10.6 \*                      10.8 \*                      10.6 \*                      9.6 →  
 10.2 \*                      10.2 \*                      10.5 \*                      9.5 →                      9.7 ↘  
 beste Teiler 39.0 (3.) 81.1 (4.) 83.5 (2.)  
 Trefferlage 1.02 mm rechts, 0.50 mm tief  
 Streuwert 1.32, horizontal: 1.74, vertikal: 0.65

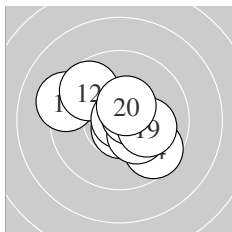

Serie 2:  
 9.2 ↖                      9.7 ↖                      10.4 \*                      9.6 ↘                      10.7 \*  
 10.9 \*                      10.3 \*                      10.6 \*                      10.1 →                      10.5 \*  
 beste Teiler 12.7 (16.) 65.7 (15.) 92.7 (18.)  
 Trefferlage 0.21 mm rechts, 0.01 mm tief  
 Streuwert 1.68, horizontal: 1.99, vertikal: 1.30

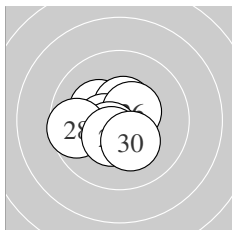

Serie 3:  
 10.7 \*                      10.8 \*                      10.3 \*                      10.5 \*                      10.5 \*  
 10.5 \*                      10.5 \*                      9.6 ←                      10.4 \*                      10.2 \*  
 beste Teiler 48.8 (22.) 55.9 (21.) 108.4 (24.)  
 Trefferlage 0.53 mm links, 0.19 mm tief  
 Streuwert 1.09, horizontal: 1.26, vertikal: 0.90

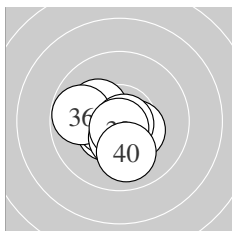

Serie 4:  
 10.5 \*                      10.5 \*                      10.2 \*                      10.7 \*                      10.4 \*  
 9.8 ←                      10.5 \*                      10.8 \*                      10.7 \*                      10.0 ↓  
 beste Teiler 39.6 (38.) 53.2 (39.) 59.3 (34.)  
 Trefferlage 0.42 mm links, 0.51 mm tief  
 Streuwert 1.05, horizontal: 1.20, vertikal: 0.89

Unterschrift des Schützen

Meyton Elektronik

Ergebnis: **419.4** (400)  
 Serien: 104.5 105.8 104.4 104.7  
 Zähler: 40 0 0 0 0 0 0 0 0 0  
 Innenzehner: 36  
 weiteste: 233 (36), 230 (34), 226 (7)  
 beste Teiler 13.0 (40.) 35.4 (4.) 40.5 (18.)  
 Trefferlage 0.12 mm rechts, 0.00 mm  
 Streuwert 0.93, horizontal: 1.06, vertikal: 0.77

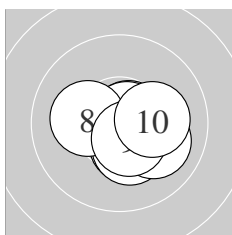
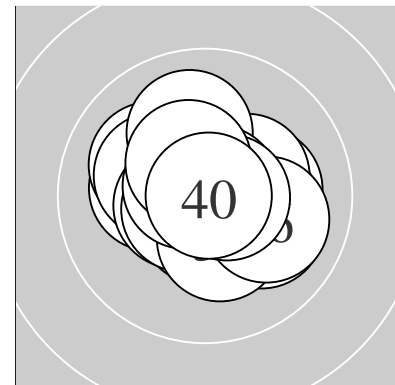

Serie 1:  
 10.4 \*                      10.3 \*                      10.6 \*                      10.8 \*                      10.7 \*  
 10.8 \*                      10.0 ↘                      10.2 \*                      10.5 \*                      10.2 \*  
 beste Teiler 35.4 (4.) 48.3 (6.) 59.9 (5.)  
 Trefferlage 0.55 mm rechts, 0.43 mm tief  
 Streuwert 0.90, horizontal: 1.06, vertikal: 0.72

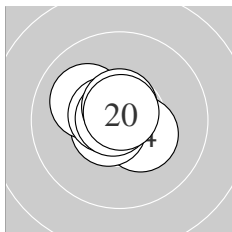

Serie 2:  
 10.6 \*                      10.7 \*                      10.6 \*                      10.4 \*                      10.6 \*  
 10.1 ↖                      10.6 \*                      10.8 \*                      10.6 \*                      10.8 \*  
 beste Teiler 40.5 (18.) 46.8 (20.) 73.9 (12.)  
 Trefferlage 0.48 mm links, 0.16 mm hoch  
 Streuwert 0.70, horizontal: 0.81, vertikal: 0.57

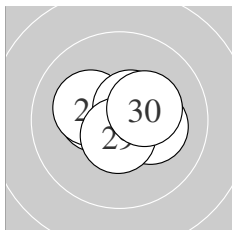

Serie 3:  
 10.4 \*                      10.3 \*                      10.5 \*                      10.6 \*                      10.7 \*  
 10.2 \*                      10.6 \*                      10.2 \*                      10.6 \*                      10.3 \*  
 beste Teiler 52.6 (25.) 92.4 (29.) 97.0 (24.)  
 Trefferlage 0.40 mm rechts, 0.19 mm hoch  
 Streuwert 0.95, horizontal: 1.21, vertikal: 0.59

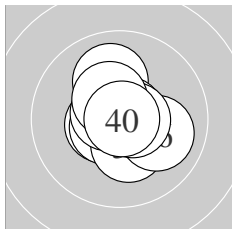

Serie 4:  
 10.5 \*                      10.6 \*                      10.3 \*                      10.0 ↑                      10.8 \*  
 10.0 ↗                      10.6 \*                      10.6 \*                      10.4 \*                      10.9 \*  
 beste Teiler 13.0 (40.) 50.7 (35.) 77.8 (37.)  
 Trefferlage 0.04 mm rechts, 0.08 mm hoch  
 Streuwert 1.01, horizontal: 0.97, vertikal: 1.05

Unterschrift des Schützen

Meyton Elektronik

Ergebnis: **420.0** (398)  
 Serien: 105.5 105.0 104.6 104.9  
 Zähler: 38 2 0 0 0 0 0 0 0 0  
 Innenzehner: 38  
 weiteste: 346 (24), 272 (15), 192 (31)  
 beste Teiler 21.9 (35.) 35.7 (34.) 44.5 (23.)  
 Trefferlage 0.27 mm rechts, 0.05 mm tief  
 Streuwert 0.90, horizontal: 0.99, vertikal: 0.80

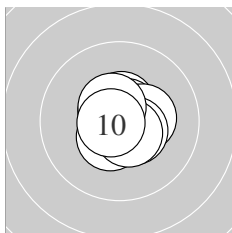
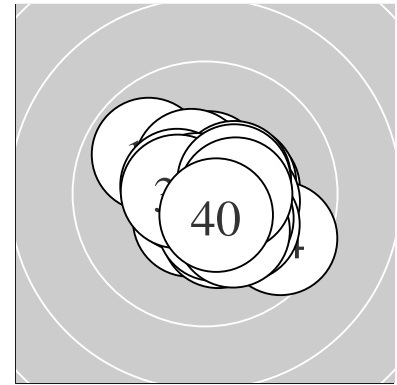

Serie 1:  
 10.5 \* 10.7 \* 10.5 \* 10.6 \* 10.3 \*  
 10.5 \* 10.6 \* 10.6 \* 10.5 \* 10.7 \*  
 beste Teiler 58.0 (10.) 70.4 (2.) 77.7 (4.)  
 Trefferlage 0.21 mm rechts, 0.10 mm hoch  
 Streuwert 0.73, horizontal: 0.75, vertikal: 0.72

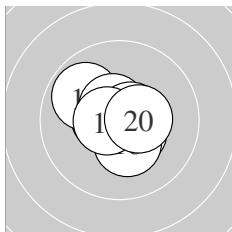

Serie 2:  
 10.6 \* 10.5 \* 10.6 \* 10.8 \* 9.9 ↘  
 10.6 \* 10.6 \* 10.3 \* 10.6 \* 10.5 \*  
 beste Teiler 46.6 (14.) 76.8 (17.) 82.1 (19.)  
 Trefferlage 0.12 mm links, 0.01 mm tief  
 Streuwert 0.97, horizontal: 1.06, vertikal: 0.87

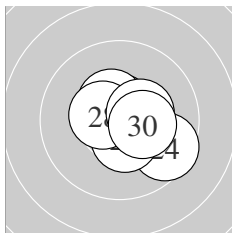

Serie 3:  
 10.7 \* 10.6 \* 10.8 \* 9.6 ↘ 10.7 \*  
 10.5 \* 10.5 \* 10.5 \* 10.4 \* 10.3 \*  
 beste Teiler 44.5 (23.) 68.9 (21.) 74.6 (25.)  
 Trefferlage 0.39 mm rechts, 0.01 mm hoch  
 Streuwert 1.09, horizontal: 1.24, vertikal: 0.91

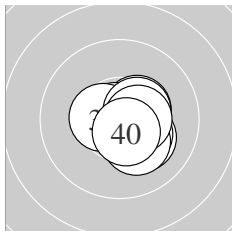

Serie 4:  
 10.2 \* 10.3 \* 10.4 \* 10.8 \* 10.9 \*  
 10.2 \* 10.5 \* 10.5 \* 10.5 \* 10.6 \*  
 beste Teiler 21.9 (35.) 35.7 (34.) 94.8 (40.)  
 Trefferlage 0.63 mm rechts, 0.32 mm tief  
 Streuwert 0.80, horizontal: 0.86, vertikal: 0.74

Unterschrift des Schützen

Ergebnis: **416.6** (394)  
 Serien: 101.9 103.4 106.0 105.3  
 Zähler: 34 6 0 0 0 0 0 0 0 0  
 Innenzehner: 34  
 weiteste: 372 (2), 315 (5), 312 (19)  
 beste Teiler 18.3 (21.) 25.6 (23.) 26.6 (40.)  
 Trefferlage 0.17 mm links, 0.16 mm tief  
 Streuwert 1.12, horizontal: 1.27, vertikal: 0.95

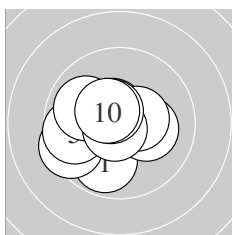
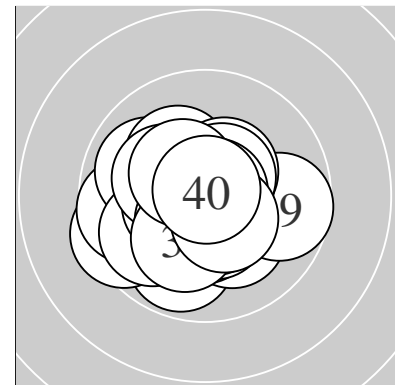

Serie 1:  
 9.8 ↙                      9.5 ↖                      10.2 \*                      10.6 \*                      9.7 ←  
 9.9 ↖                      10.5 \*                      10.7 \*                      10.5 \*                      10.5 \*  
 beste Teiler 51.0 (8.) 98.9 (4.) 102.4 (9.)  
 Trefferlage 0.90 mm links, 0.16 mm tief  
 Streuwert 1.46, horizontal: 1.69, vertikal: 1.19

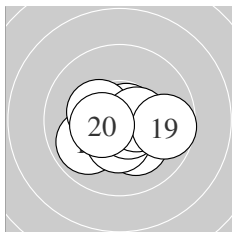

Serie 2:  
 10.7 \*                      10.6 \*                      9.9 ↖                      10.2 \*                      10.4 \*  
 10.3 \*                      10.7 \*                      10.5 \*                      9.7 →                      10.4 \*  
 beste Teiler 54.9 (11.) 75.0 (17.) 82.4 (12.)  
 Trefferlage 0.19 mm rechts, 0.55 mm tief  
 Streuwert 1.20, horizontal: 1.52, vertikal: 0.76

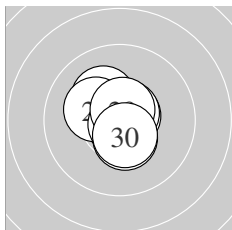

Serie 3:  
 10.9 \*                      10.2 \*                      10.9 \*                      10.7 \*                      10.2 \*  
 10.4 \*                      10.7 \*                      10.8 \*                      10.7 \*                      10.5 \*  
 beste Teiler 18.3 (21.) 25.6 (23.) 29.4 (28.)  
 Trefferlage 0.10 mm links, 0.11 mm hoch  
 Streuwert 0.79, horizontal: 0.74, vertikal: 0.84

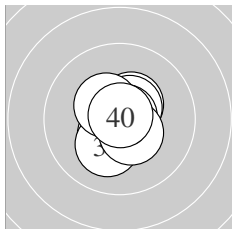

Serie 4:  
 10.4 \*                      10.5 \*                      10.6 \*                      10.2 \*                      10.6 \*  
 10.5 \*                      10.8 \*                      10.4 \*                      10.5 \*                      10.8 \*  
 beste Teiler 26.6 (40.) 40.3 (37.) 76.0 (35.)  
 Trefferlage 0.12 mm rechts, 0.05 mm tief  
 Streuwert 0.84, horizontal: 0.69, vertikal: 0.97

Unterschrift des Schützen

Ergebnis: **421.8** (399)  
 Serien: 106.4 104.7 105.6 105.1  
 Zähler: 39 1 0 0 0 0 0 0 0 0  
 Innenzehner: 37  
 weiteste: 263 (11), 217 (32), 201 (17)  
 beste Teiler 26.9 (20.) 30.5 (28.) 36.4 (8.)  
 Trefferlage 0.03 mm rechts, 0.01 mm tief  
 Streuwert 0.83, horizontal: 1.03, vertikal: 0.56

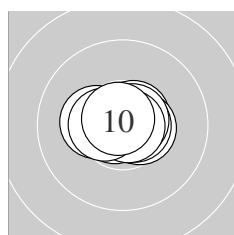
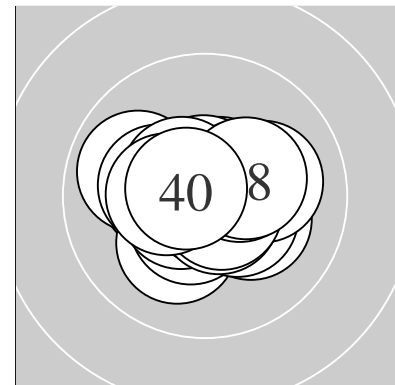

Serie 1:  
 10.3 \*                      10.6 \*                      10.7 \*                      10.5 \*                      10.8 \*  
 10.7 \*                      10.7 \*                      10.8 \*                      10.5 \*                      10.8 \*  
 beste Teiler 36.4 (8.) 48.0 (10.) 48.5 (5.)  
 Trefferlage 0.06 mm rechts, 0.09 mm hoch  
 Streuwert 0.65, horizontal: 0.89, vertikal: 0.24

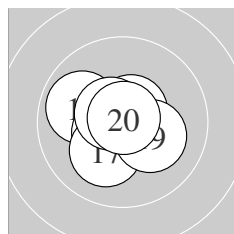

Serie 2:  
 9.9 ↖                      10.7 \*                      10.6 \*                      10.6 \*                      10.7 \*  
 10.5 \*                      10.1 ↙                      10.6 \*                      10.2 \*                      10.8 \*  
 beste Teiler 26.9 (20.) 58.9 (15.) 67.8 (12.)  
 Trefferlage 0.35 mm links, 0.11 mm tief  
 Streuwert 0.98, horizontal: 1.13, vertikal: 0.81

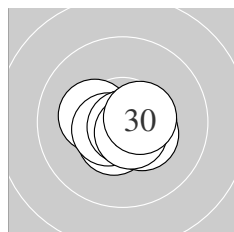

Serie 3:  
 10.3 \*                      10.5 \*                      10.8 \*                      10.5 \*                      10.6 \*  
 10.4 \*                      10.6 \*                      10.8 \*                      10.6 \*                      10.5 \*  
 beste Teiler 30.5 (28.) 38.9 (23.) 81.8 (29.)  
 Trefferlage 0.18 mm rechts, 0.33 mm tief  
 Streuwert 0.75, horizontal: 0.96, vertikal: 0.45

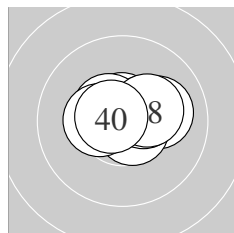

Serie 4:  
 10.7 \*                      10.1 →                      10.7 \*                      10.6 \*                      10.4 \*  
 10.7 \*                      10.5 \*                      10.3 \*                      10.4 \*                      10.7 \*  
 beste Teiler 71.1 (33.) 72.2 (36.) 73.2 (31.)  
 Trefferlage 0.25 mm rechts, 0.31 mm hoch  
 Streuwert 0.87, horizontal: 1.16, vertikal: 0.41

Unterschrift des Schützen

Ergebnis: **419.1** (396)  
 Serien: 103.5 104.2 105.5 105.9  
 Zähler: 36 4 0 0 0 0 0 0 0 0  
 Innenzehner: 35  
 weiteste: 297 (10), 272 (2), 262 (12)  
 beste Teiler 16.1 (1.) 34.6 (25.) 35.6 (16.)  
 Trefferlage 0.16 mm links, 0.70 mm tief  
 Streuwert 0.83, horizontal: 0.78, vertikal: 0.88

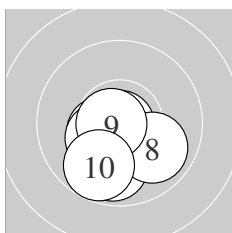
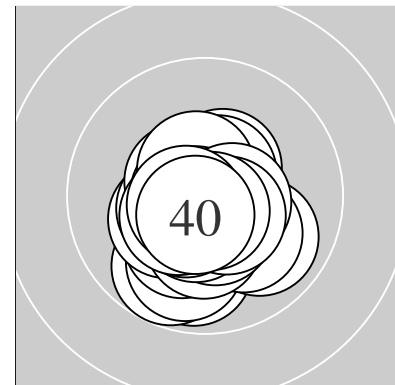

Serie 1:  
 10.9 \*                    9.9 ↓                    10.5 \*                    10.5 \*                    10.4 \*  
 10.3 \*                    10.6 \*                    9.9 ↘                    10.7 \*                    9.8 ↓  
 beste Teiler 16.1 (1.) 52.2 (9.) 96.1 (7.)  
 Trefferlage 0.27 mm links, 1.21 mm tief  
 Streuwert 0.95, horizontal: 0.99, vertikal: 0.91

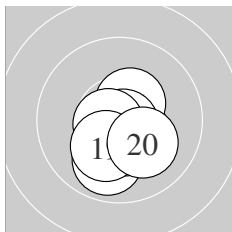

Serie 2:  
 10.7 \*                    9.9 ↓                    10.4 \*                    10.5 \*                    10.5 \*  
 10.8 \*                    10.4 \*                    10.7 \*                    10.2 \*                    10.1 ↘  
 beste Teiler 35.6 (16.) 64.0 (11.) 75.2 (18.)  
 Trefferlage 0.12 mm rechts, 0.83 mm tief  
 Streuwert 0.92, horizontal: 0.81, vertikal: 1.01

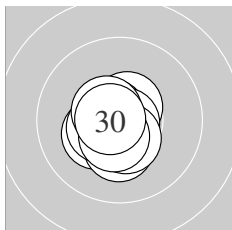

Serie 3:  
 10.3 \*                    10.3 \*                    10.6 \*                    10.7 \*                    10.8 \*  
 10.5 \*                    10.5 \*                    10.6 \*                    10.5 \*                    10.7 \*  
 beste Teiler 34.6 (25.) 60.2 (30.) 62.6 (24.)  
 Trefferlage 0.37 mm links, 0.36 mm tief  
 Streuwert 0.74, horizontal: 0.65, vertikal: 0.81

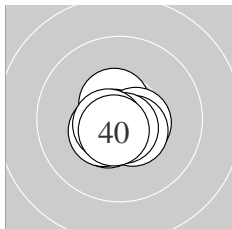

Serie 4:  
 10.5 \*                    10.5 \*                    10.8 \*                    10.8 \*                    10.4 \*  
 10.5 \*                    10.5 \*                    10.7 \*                    10.6 \*                    10.6 \*  
 beste Teiler 47.0 (34.) 50.2 (33.) 60.7 (38.)  
 Trefferlage 0.14 mm links, 0.40 mm tief  
 Streuwert 0.60, horizontal: 0.67, vertikal: 0.53

Unterschrift des Schützen

Meyton Elektronik

Ergebnis: **419.1** (400)  
 Serien: 105.7 105.4 104.8 103.2  
 Zähler: 40 0 0 0 0 0 0 0 0 0  
 Innenzehner: 33  
 weiteste: 233 (36), 229 (35), 223 (27)  
 beste Teiler 13.0 (20.) 17.0 (8.) 18.4 (16.)  
 Trefferlage 0.32 mm links, 0.15 mm hoch  
 Streuwert 0.94, horizontal: 1.11, vertikal: 0.72

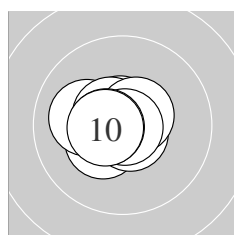
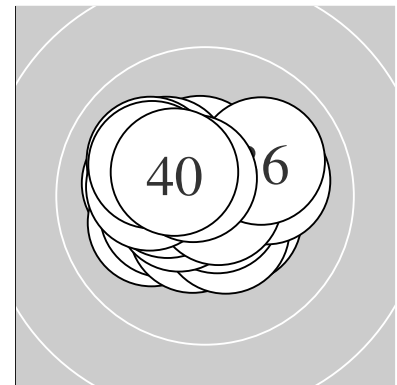

Serie 1:  
 10.4 \*                      10.6 \*                      10.7 \*                      10.1 ←                      10.6 \*  
 10.7 \*                      10.6 \*                      10.9 \*                      10.6 \*                      10.5 \*  
 beste Teiler 17.0 (8.) 63.6 (6.) 66.7 (3.)  
 Trefferlage 0.54 mm links, 0.09 mm hoch  
 Streuwert 0.71, horizontal: 0.86, vertikal: 0.53

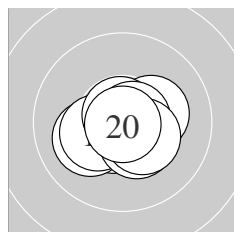

Serie 2:  
 10.6 \*                      10.1 ↙                      10.3 \*                      10.3 \*                      10.4 \*  
 10.9 \*                      10.8 \*                      10.7 \*                      10.4 \*                      10.9 \*  
 beste Teiler 13.0 (20.) 18.4 (16.) 45.2 (17.)  
 Trefferlage 0.01 mm rechts, 0.31 mm tief  
 Streuwert 0.90, horizontal: 1.11, vertikal: 0.60

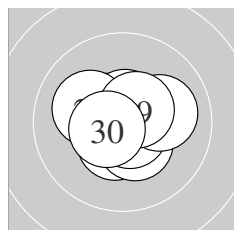

Serie 3:  
 10.9 \*                      10.5 \*                      10.4 \*                      10.5 \*                      10.7 \*  
 10.6 \*                      10.1 →                      10.1 ↖                      10.5 \*                      10.5 \*  
 beste Teiler 19.8 (21.) 64.4 (25.) 86.1 (26.)  
 Trefferlage 0.00 mm , 0.04 mm hoch  
 Streuwert 0.98, horizontal: 1.13, vertikal: 0.80

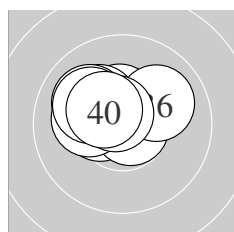

Serie 4:  
 10.4 \*                      10.4 \*                      10.8 \*                      10.2 \*                      10.0 ↘  
 10.0 ↗                      10.2 \*                      10.1 ↖                      10.7 \*                      10.4 \*  
 beste Teiler 50.6 (33.) 74.8 (39.) 129.2 (31.)  
 Trefferlage 0.76 mm links, 0.77 mm hoch  
 Streuwert 0.97, horizontal: 1.26, vertikal: 0.55

Unterschrift des Schützen

Meyton Elektronik

Ergebnis: **416.4** (398)  
 Serien: 104.6 102.9 104.3 104.6  
 Zähler: 38 2 0 0 0 0 0 0 0 0  
 Innenzehner: 33  
 weiteste: 375 (17), 264 (22), 229 (27)  
 beste Teiler 34.5 (36.) 45.2 (23.) 58.4 (30.)  
 Trefferlage 0.03 mm links, 0.32 mm tief  
 Streuwert 1.07, horizontal: 1.20, vertikal: 0.92

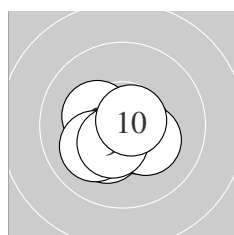
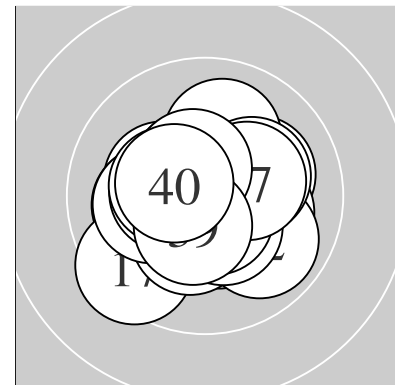

Serie 1:  
 10.7 \*                      10.3 \*                      10.6 \*                      10.3 \*                      10.1 ↙  
 10.7 \*                      10.5 \*                      10.3 \*                      10.4 \*                      10.7 \*  
 beste Teiler 61.7 (10.) 66.4 (1.) 71.8 (6.)  
 Trefferlage 0.12 mm links, 0.62 mm tief  
 Streuwert 0.92, horizontal: 1.12, vertikal: 0.66

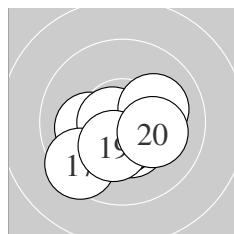

Serie 2:  
 10.4 \*                      10.1 ←                      10.6 \*                      10.4 \*                      10.6 \*  
 10.7 \*                      9.5 ↘                      10.1 →                      10.3 \*                      10.2 \*  
 beste Teiler 65.0 (16.) 87.0 (15.) 99.4 (13.)  
 Trefferlage 0.02 mm rechts, 0.73 mm tief  
 Streuwert 1.30, horizontal: 1.56, vertikal: 0.96

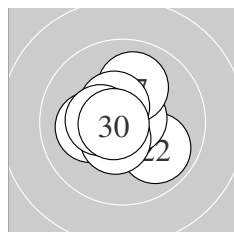

Serie 3:  
 10.7 \*                      9.9 ↘                      10.8 \*                      10.7 \*                      10.1 ←  
 10.5 \*                      10.0 ↑                      10.5 \*                      10.4 \*                      10.7 \*  
 beste Teiler 45.2 (23.) 58.4 (30.) 60.5 (24.)  
 Trefferlage 0.23 mm links, 0.04 mm tief  
 Streuwert 1.10, horizontal: 1.13, vertikal: 1.07

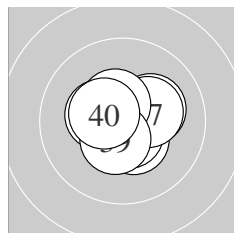

Serie 4:  
 10.5 \*                      10.4 \*                      10.2 \*                      10.4 \*                      10.6 \*  
 10.8 \*                      10.3 \*                      10.5 \*                      10.5 \*                      10.4 \*  
 beste Teiler 34.5 (36.) 83.1 (35.) 106.5 (31.)  
 Trefferlage 0.17 mm rechts, 0.09 mm hoch  
 Streuwert 0.96, horizontal: 1.09, vertikal: 0.80

Unterschrift des Schützen

Meyton Elektronik



Ergebnis: **404.4** (390)  
 Serien: 101.3 101.8 99.3 102.0  
 Zähler: 31 8 1 0 0 0 0 0 0 0  
 Innenzehner: 20  
 weiteste: 728 (21), 370 (16), 323 (1)  
 beste Teiler 58.6 (9.) 86.3 (36.) 95.1 (5.)  
 Trefferlage 0.01 mm links, 0.01 mm hoch  
 Streuwert 1.70, horizontal: 2.03, vertikal: 1.29

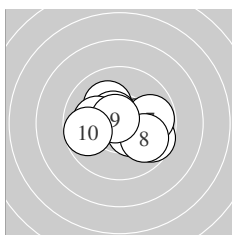
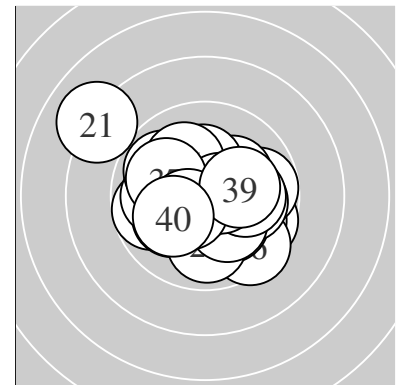

Serie 1:  
 9.7 ↘ 10.3 \* 10.1 ↖ 10.4 \* 10.6 \*  
 10.1 ← 9.8 → 9.9 ↘ 10.7 \* 9.7 ←  
 beste Teiler 58.6 (9.) 95.1 (5.) 137.4 (4.)  
 Trefferlage 0.35 mm rechts, 0.08 mm tief  
 Streuwert 1.63, horizontal: 2.08, vertikal: 0.98

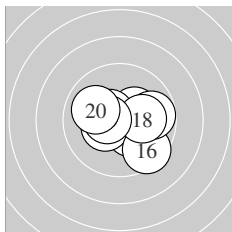

Serie 2:  
 10.4 \* 10.3 \* 10.3 \* 10.4 \* 10.5 \*  
 9.5 ↘ 9.8 → 10.1 → 10.5 \* 10.0 ↖  
 beste Teiler 109.5 (15.) 115.1 (19.) 135.0 (11.)  
 Trefferlage 0.30 mm rechts, 0.19 mm tief  
 Streuwert 1.55, horizontal: 1.88, vertikal: 1.11

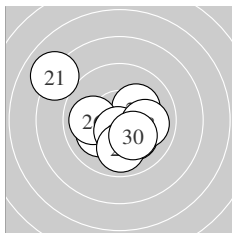

Serie 3:  
 8.0 ↘ 10.1 ↖ 10.2 \* 10.2 \* 10.2 \*  
 10.0 ← 10.5 \* 10.0 → 9.9 ↓ 10.2 \*  
 beste Teiler 101.1 (27.) 183.3 (24.) 188.2 (25.)  
 Trefferlage 0.20 mm links, 0.25 mm tief  
 Streuwert 2.24, horizontal: 2.57, vertikal: 1.85

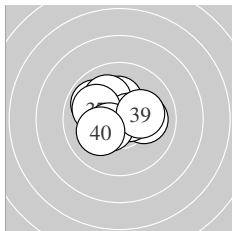

Serie 4:  
 10.3 \* 10.2 \* 10.1 → 9.9 ↘ 10.1 ↖  
 10.6 \* 10.0 ↖ 10.5 \* 10.2 \* 10.1 ←  
 beste Teiler 86.3 (36.) 121.0 (38.) 173.4 (31.)  
 Trefferlage 0.49 mm links, 0.59 mm hoch  
 Streuwert 1.38, horizontal: 1.66, vertikal: 1.03

Unterschrift des Schützen

Ergebnis: **409.5** (394)  
 Serien: 102.4 102.5 102.3 102.3  
 Zähler: 34 6 0 0 0 0 0 0 0 0  
 Innenzehner: 28  
 weiteste: 394 (4), 376 (40), 373 (26)  
 beste Teiler 55.9 (7.) 62.8 (33.) 68.6 (27.)  
 Trefferlage 0.02 mm rechts, 0.31 mm tief  
 Streuwert 1.41, horizontal: 1.73, vertikal: 0.99

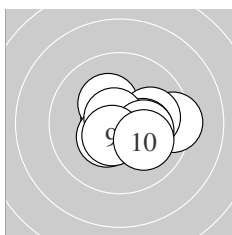
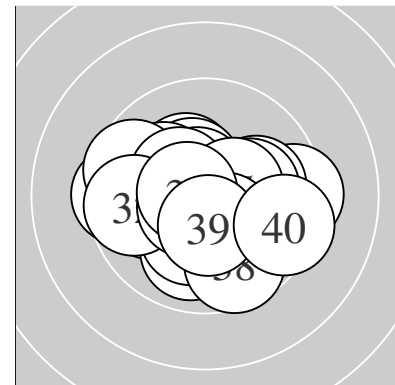

Serie 1:  
 10.6 \*                      10.3 \*                      10.4 \*                      9.4 →                      10.0 →  
 10.2 \*                      10.7 \*                      10.2 \*                      10.5 \*                      10.1 ↘  
 beste Teiler 55.9 (7.) 77.6 (1.) 107.7 (9.)  
 Trefferlage 0.80 mm rechts, 0.13 mm tief  
 Streuwert 1.34, horizontal: 1.70, vertikal: 0.84

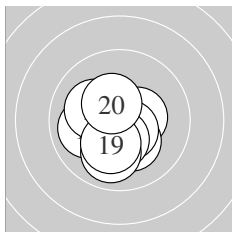

Serie 2:  
 10.4 \*                      10.2 \*                      10.2 \*                      10.0 ←                      10.6 \*  
 10.1 ↖                      10.4 \*                      10.0 ↓                      10.2 \*                      10.4 \*  
 beste Teiler 98.5 (15.) 133.6 (11.) 136.4 (20.)  
 Trefferlage 0.51 mm links, 0.65 mm tief  
 Streuwert 1.20, horizontal: 1.23, vertikal: 1.16

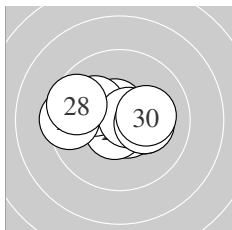

Serie 3:  
 10.6 \*                      10.2 \*                      10.6 \*                      10.6 \*                      10.1 ↖  
 9.5 ←                      10.7 \*                      9.6 ↖                      10.2 \*                      10.2 \*  
 beste Teiler 68.6 (27.) 77.4 (24.) 81.3 (23.)  
 Trefferlage 0.27 mm links, 0.18 mm hoch  
 Streuwert 1.53, horizontal: 2.06, vertikal: 0.66

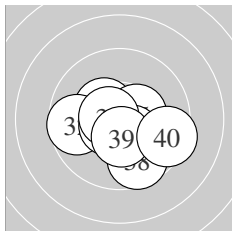

Serie 4:  
 10.4 \*                      9.7 ←                      10.7 \*                      10.6 \*                      10.4 \*  
 10.4 \*                      10.6 \*                      9.7 ↓                      10.4 \*                      9.4 →  
 beste Teiler 62.8 (33.) 81.5 (37.) 92.9 (34.)  
 Trefferlage 0.05 mm rechts, 0.65 mm tief  
 Streuwert 1.50, horizontal: 1.81, vertikal: 1.09

Unterschrift des Schützen

Ergebnis: **406.2** (387)  
 Serien: 100.8 102.9 99.7 102.8  
 Zähler: 28 11 1 0 0 0 0 0 0 0  
 Innenzehner: 23  
 weiteste: 648 (29), 416 (1), 334 (3)  
 beste Teiler 40.6 (13.) 70.7 (37.) 78.3 (26.)  
 Trefferlage 1.02 mm links, 0.22 mm hoch  
 Streuwert 1.47, horizontal: 1.63, vertikal: 1.30

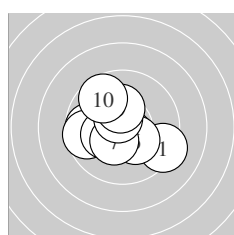
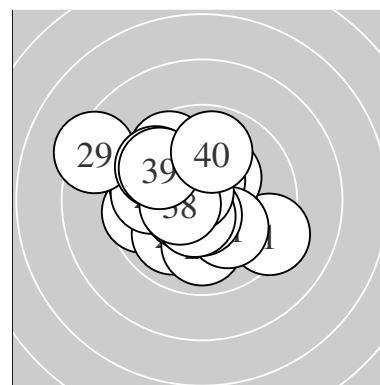

Serie 1:  
 9.3 ↘                      9.7 ←                      9.6 ←                      10.6 \*                      10.3 \*  
 10.3 \*                      10.4 \*                      10.6 \*                      10.3 \*                      9.7 ↘  
 beste Teiler 88.7 (4.) 89.8 (8.) 145.1 (7.)  
 Trefferlage 0.56 mm links, 0.12 mm tief  
 Streuwert 1.78, horizontal: 2.08, vertikal: 1.42

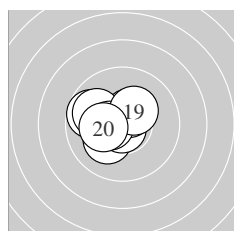

Serie 2:  
 10.2 \*                      10.2 \*                      10.8 \*                      10.6 \*                      10.5 \*  
 9.7 ↙                      9.9 ↙                      10.5 \*                      10.3 \*                      10.2 \*  
 beste Teiler 40.6 (13.) 95.7 (14.) 115.4 (15.)  
 Trefferlage 1.07 mm links, 0.30 mm hoch  
 Streuwert 1.07, horizontal: 1.26, vertikal: 0.84

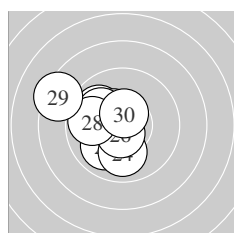

Serie 3:  
 10.1 ↖                      9.9 ↖                      10.0 ↗                      10.0 ↓                      10.4 \*  
 10.6 \*                      10.0 ↖                      9.8 ←                      8.4 ↖                      10.5 \*  
 beste Teiler 78.3 (26.) 108.7 (30.) 137.0 (25.)  
 Trefferlage 1.74 mm links, 0.35 mm hoch  
 Streuwert 1.69, horizontal: 1.79, vertikal: 1.58

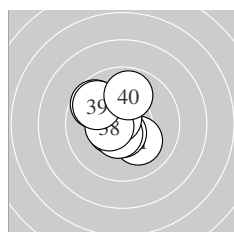

Serie 4:  
 10.1 ↘                      10.6 \*                      10.5 \*                      10.4 \*                      9.7 ↘  
 10.6 \*                      10.7 \*                      10.5 \*                      9.8 ↖                      9.9 ↑  
 beste Teiler 70.7 (37.) 84.1 (32.) 98.4 (36.)  
 Trefferlage 0.70 mm links, 0.36 mm hoch  
 Streuwert 1.30, horizontal: 1.21, vertikal: 1.38

Unterschrift des Schützen

Meyton Elektronik

Ergebnis: **410.1** (395)  
 Serien: 103.1 102.1 100.9 104.0  
 Zähler: 35 5 0 0 0 0 0 0 0 0  
 Innenzehner: 27  
 weiteste: 452 (23), 393 (11), 343 (22)  
 beste Teiler 16.1 (40.) 34.5 (13.) 49.7 (39.)  
 Trefferlage 0.40 mm rechts, 0.54 mm hoch  
 Streuwert 1.34, horizontal: 1.57, vertikal: 1.05

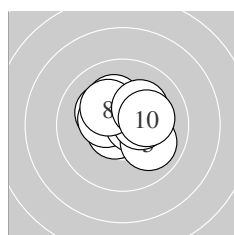
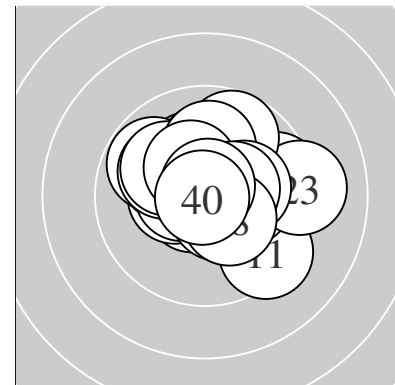

Serie 1:  
 10.2 \*                      10.7 \*                      10.4 \*                      10.6 \*                      10.0 ↘  
 10.2 \*                      10.4 \*                      10.2 \*                      10.2 \*                      10.2 \*  
 beste Teiler 74.4 (2.) 85.4 (4.) 140.4 (3.)  
 Trefferlage 0.22 mm rechts, 0.51 mm hoch  
 Streuwert 1.20, horizontal: 1.42, vertikal: 0.94

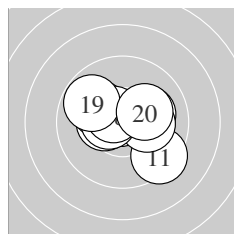

Serie 2:  
 9.4 ↘                      10.1 →                      10.8 \*                      10.4 \*                      10.2 \*  
 10.1 ↖                      10.5 \*                      10.6 \*                      9.8 ↖                      10.2 \*  
 beste Teiler 34.5 (13.) 94.3 (18.) 111.4 (17.)  
 Trefferlage 0.08 mm rechts, 0.22 mm hoch  
 Streuwert 1.56, horizontal: 1.90, vertikal: 1.13

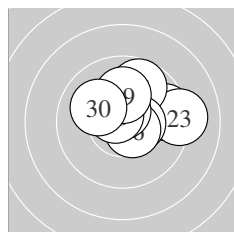

Serie 3:  
 10.0 ↑                      9.6 →                      9.1 →                      9.7 ↑                      10.5 \*  
 10.6 \*                      10.6 \*                      10.6 \*                      10.1 ↑                      10.1 ↖  
 beste Teiler 80.6 (28.) 89.0 (27.) 97.2 (26.)  
 Trefferlage 0.92 mm rechts, 1.03 mm hoch  
 Streuwert 1.52, horizontal: 1.86, vertikal: 1.08

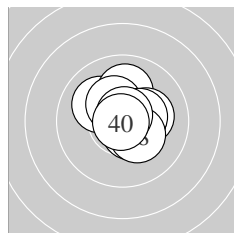

Serie 4:  
 10.1 ↖                      10.0 ↑                      10.2 \*                      10.3 \*                      10.5 \*  
 10.5 \*                      10.4 \*                      10.3 \*                      10.8 \*                      10.9 \*  
 beste Teiler 16.1 (40.) 49.7 (39.) 102.4 (36.)  
 Trefferlage 0.38 mm rechts, 0.41 mm hoch  
 Streuwert 1.05, horizontal: 1.08, vertikal: 1.02

Unterschrift des Schützen

Meyton Elektronik

Ergebnis: **417.1** (398)  
 Serien: 104.3 104.7 104.0 104.1  
 Zähler: 38 2 0 0 0 0 0 0 0 0  
 Innenzehner: 34  
 weiteste: 276 (37), 272 (21), 240 (2)  
 beste Teiler 18.2 (3.) 34.2 (31.) 38.2 (39.)  
 Trefferlage 0.13 mm rechts, 0.08 mm tief  
 Streuwert 1.04, horizontal: 1.26, vertikal: 0.77

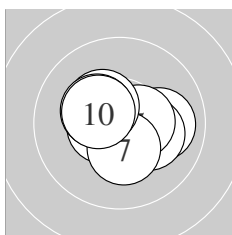
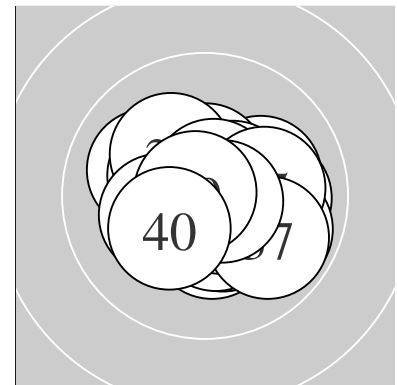

Serie 1:  
 10.7 \* 10.0 → 10.9 \* 10.2 \* 10.5 \*  
 10.6 \* 10.3 \* 10.4 \* 10.3 \* 10.4 \*  
 beste Teiler 18.2 (3.) 55.9 (1.) 100.4 (6.)  
 Trefferlage 0.09 mm rechts, 0.06 mm tief  
 Streuwert 1.08, horizontal: 1.32, vertikal: 0.76

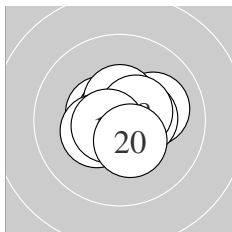

Serie 2:  
 10.7 \* 10.1 → 10.4 \* 10.5 \* 10.7 \*  
 10.5 \* 10.3 \* 10.5 \* 10.6 \* 10.4 \*  
 beste Teiler 51.2 (15.) 73.2 (11.) 80.0 (19.)  
 Trefferlage 0.21 mm rechts, 0.14 mm hoch  
 Streuwert 0.93, horizontal: 1.10, vertikal: 0.71

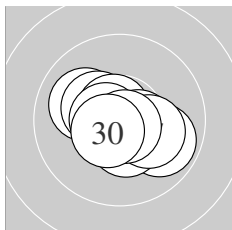

Serie 3:  
 9.9 ↘ 10.0 ↖ 10.3 \* 10.7 \* 10.4 \*  
 10.5 \* 10.2 \* 10.6 \* 10.8 \* 10.6 \*  
 beste Teiler 50.0 (29.) 67.6 (24.) 84.0 (28.)  
 Trefferlage 0.06 mm rechts, 0.23 mm tief  
 Streuwert 1.15, horizontal: 1.42, vertikal: 0.78

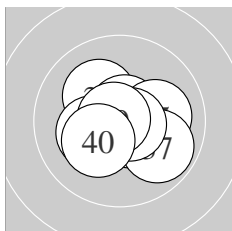

Serie 4:  
 10.8 \* 10.6 \* 10.2 \* 10.7 \* 10.1 →  
 10.2 \* 9.8 ↘ 10.7 \* 10.8 \* 10.2 \*  
 beste Teiler 34.2 (31.) 38.2 (39.) 65.1 (38.)  
 Trefferlage 0.18 mm rechts, 0.17 mm tief  
 Streuwert 1.15, horizontal: 1.37, vertikal: 0.89

Unterschrift des Schützen

Ergebnis: **399.5** (381)  
 Serien: 100.7 98.1 100.2 100.5  
 Zähler: 23 15 2 0 0 0 0 0 0 0  
 Innenzehner: 17  
 weiteste: 541 (22), 504 (11), 474 (16)  
 beste Teiler 51.0 (35.) 68.0 (1.) 69.6 (17.)  
 Trefferlage 0.17 mm links, 0.73 mm tief  
 Streuwert 1.87, horizontal: 1.96, vertikal: 1.77

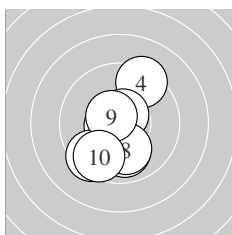
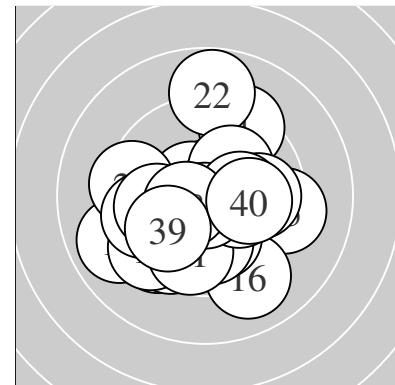

Serie 1:  
 10.7 \*                      9.9 ↙                      10.6 \*                      9.3 ↗                      9.9 ↓  
 10.6 \*                      9.5 ↙                      10.0 ↓                      10.6 \*                      9.6 ↙  
 beste Teiler 68.0 (1.) 79.8 (6.) 89.2 (3.)  
 Trefferlage 0.44 mm links, 0.76 mm tief  
 Streuwert 1.76, horizontal: 1.28, vertikal: 2.13

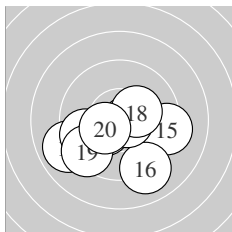

Serie 2:  
 8.9 ↙                      10.0 →                      9.7 ↙                      10.3 \*                      9.3 →  
 9.1 ↓                      10.7 \*                      10.3 \*                      9.4 ↙                      10.4 \*  
 beste Teiler 69.6 (17.) 145.8 (20.) 155.5 (14.)  
 Trefferlage 0.20 mm links, 1.27 mm tief  
 Streuwert 2.21, horizontal: 2.78, vertikal: 1.42

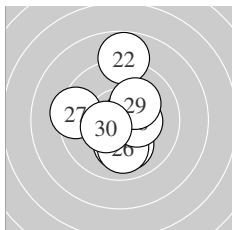

Serie 3:  
 10.3 \*                      8.8 ↑                      10.1 ↓                      10.1 ↓                      10.6 \*  
 10.0 ↓                      9.4 ←                      10.3 \*                      10.2 \*                      10.4 \*  
 beste Teiler 91.7 (25.) 132.3 (30.) 152.3 (28.)  
 Trefferlage 0.04 mm rechts, 0.09 mm tief  
 Streuwert 1.98, horizontal: 1.56, vertikal: 2.33

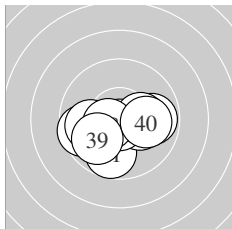

Serie 4:  
 9.7 ↓                      9.6 ←                      9.8 →                      10.2 \*                      10.7 \*  
 10.2 \*                      9.9 ←                      10.5 \*                      9.9 ↙                      10.0 →  
 beste Teiler 51.0 (35.) 110.0 (38.) 183.1 (34.)  
 Trefferlage 0.07 mm links, 0.78 mm tief  
 Streuwert 1.65, horizontal: 2.15, vertikal: 0.91

Unterschrift des Schützen

Meyton Elektronik

Ergebnis: **415.4** (397)  
 Serien: 105.1 103.2 103.5 103.6  
 Zähler: 38 1 1 0 0 0 0 0 0  
 Innenzehner: 30  
 weiteste: 599 (14), 452 (24), 247 (6)  
 beste Teiler 16.6 (10.) 30.0 (12.) 32.0 (17.)  
 Trefferlage 0.45 mm rechts, 0.05 mm tief  
 Streuwert 1.24, horizontal: 1.42, vertikal: 1.03

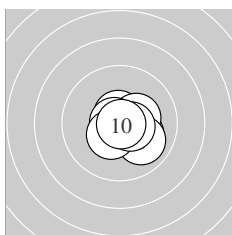
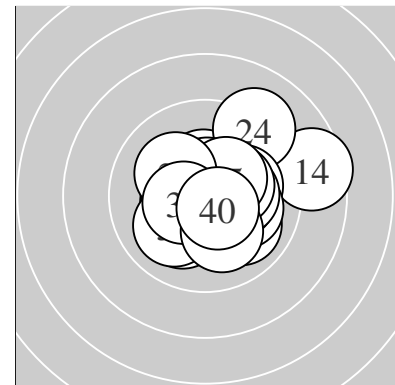

Serie 1:  
 10.7 \*                      10.1 ↘                      10.7 \*                      10.3 \*                      10.7 \*  
 10.0 ↘                      10.8 \*                      10.4 \*                      10.5 \*                      10.9 \*  
 beste Teiler 16.6 (10.) 49.8 (7.) 64.5 (3.)  
 Trefferlage 0.56 mm rechts, 0.35 mm tief  
 Streuwert 0.85, horizontal: 0.96, vertikal: 0.72

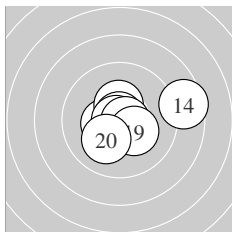

Serie 2:  
 10.3 \*                      10.8 \*                      10.4 \*                      8.6 →                      10.4 \*  
 10.8 \*                      10.8 \*                      10.7 \*                      10.3 \*                      10.1 ↙  
 beste Teiler 30.0 (12.) 32.0 (17.) 33.5 (16.)  
 Trefferlage 0.34 mm rechts, 0.08 mm tief  
 Streuwert 1.65, horizontal: 2.09, vertikal: 1.03

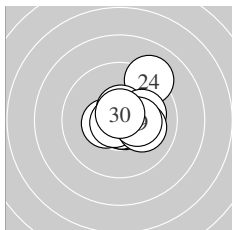

Serie 3:  
 10.7 \*                      10.8 \*                      10.4 \*                      9.1 ↗                      10.6 \*  
 10.7 \*                      10.1 →                      10.1 →                      10.3 \*                      10.7 \*  
 beste Teiler 42.9 (22.) 52.7 (26.) 59.1 (30.)  
 Trefferlage 0.74 mm rechts, 0.35 mm hoch  
 Streuwert 1.27, horizontal: 1.27, vertikal: 1.27

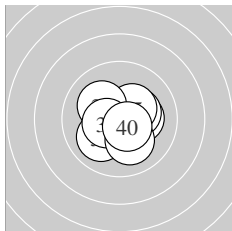

Serie 4:  
 10.8 \*                      10.6 \*                      10.2 \*                      10.3 \*                      10.4 \*  
 10.0 ↙                      10.1 ↘                      10.5 \*                      10.1 ↓                      10.6 \*  
 beste Teiler 49.4 (31.) 88.2 (32.) 96.8 (40.)  
 Trefferlage 0.18 mm rechts, 0.13 mm tief  
 Streuwert 1.18, horizontal: 1.30, vertikal: 1.06

Unterschrift des Schützen

Meyton Elektronik

Ergebnis: **421.5** (399)  
 Serien: 105.8 106.4 105.7 103.6  
 Zähler: 39 1 0 0 0 0 0 0 0 0  
 Innenzehner: 37  
 weiteste: 278 (33), 213 (25), 212 (9)  
 beste Teiler 10.8 (20.) 20.2 (28.) 23.5 (23.)  
 Trefferlage 0.27 mm links, 0.35 mm tief  
 Streuwert 0.81, horizontal: 0.89, vertikal: 0.73

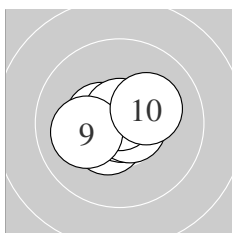
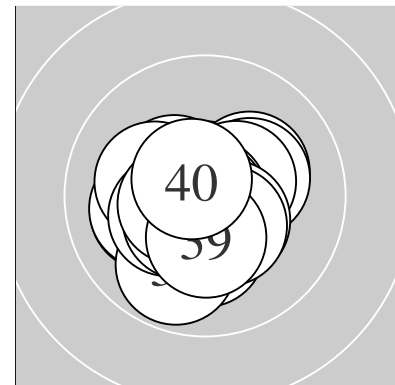

Serie 1:  
 10.8 \*                      10.6 \*                      10.8 \*                      10.5 \*                      10.5 \*  
 10.9 \*                      10.7 \*                      10.7 \*                      10.1 ←                      10.2 \*  
 beste Teiler 23.6 (6.) 29.8 (3.) 39.0 (1.)  
 Trefferlage 0.24 mm links, 0.04 mm tief  
 Streuwert 0.82, horizontal: 1.01, vertikal: 0.56

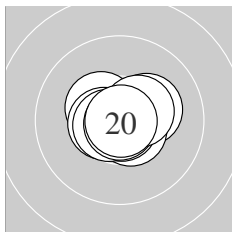

Serie 2:  
 10.2 \*                      10.4 \*                      10.6 \*                      10.9 \*                      10.6 \*  
 10.8 \*                      10.7 \*                      10.9 \*                      10.4 \*                      10.9 \*  
 beste Teiler 10.8 (20.) 24.0 (14.) 24.0 (18.)  
 Trefferlage 0.07 mm rechts, 0.00 mm  
 Streuwert 0.72, horizontal: 0.90, vertikal: 0.48

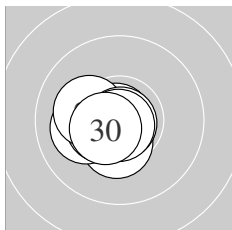

Serie 3:  
 10.8 \*                      10.6 \*                      10.9 \*                      10.4 \*                      10.1 ←  
 10.5 \*                      10.2 \*                      10.9 \*                      10.8 \*                      10.5 \*  
 beste Teiler 20.2 (28.) 23.5 (23.) 33.7 (29.)  
 Trefferlage 0.66 mm links, 0.40 mm tief  
 Streuwert 0.66, horizontal: 0.79, vertikal: 0.51

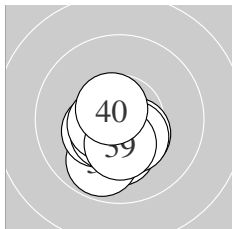

Serie 4:  
 10.6 \*                      10.2 \*                      9.8 ↓                      10.3 \*                      10.5 \*  
 10.5 \*                      10.4 \*                      10.4 \*                      10.3 \*                      10.6 \*  
 beste Teiler 80.4 (40.) 84.0 (31.) 106.6 (36.)  
 Trefferlage 0.25 mm links, 1.00 mm tief  
 Streuwert 0.85, horizontal: 0.83, vertikal: 0.87

Unterschrift des Schützen

Meyton Elektronik



Ergebnis: **420.6** (399)  
 Serien: 105.4 105.8 105.3 104.1  
 Zähler: 39 1 0 0 0 0 0 0 0 0  
 Innenzehner: 38  
 weiteste: 296 (39), 205 (3), 191 (38)  
 beste Teiler 36.7 (10.) 44.3 (6.) 53.6 (18.)  
 Trefferlage 0.08 mm links, 0.00 mm  
 Streuwert 0.85, horizontal: 0.86, vertikal: 0.84

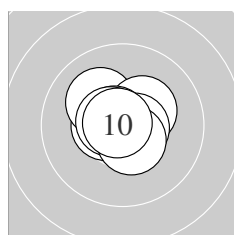
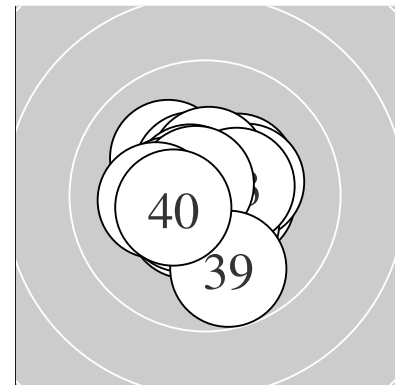

Serie 1:  
 10.5 \*                      10.5 \*                      10.1 ↖                      10.3 \*                      10.7 \*  
 10.8 \*                      10.6 \*                      10.6 \*                      10.5 \*                      10.8 \*  
 beste Teiler 36.7 (10.) 44.3 (6.) 60.8 (5.)  
 Trefferlage 0.26 mm links, 0.28 mm hoch  
 Streuwert 0.77, horizontal: 0.86, vertikal: 0.68

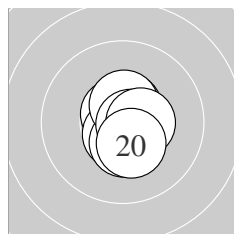

Serie 2:  
 10.7 \*                      10.7 \*                      10.6 \*                      10.6 \*                      10.4 \*  
 10.7 \*                      10.5 \*                      10.7 \*                      10.5 \*                      10.4 \*  
 beste Teiler 53.6 (18.) 62.5 (11.) 69.4 (16.)  
 Trefferlage 0.31 mm rechts, 0.07 mm tief  
 Streuwert 0.70, horizontal: 0.49, vertikal: 0.86

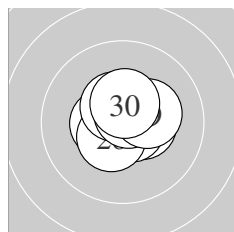

Serie 3:  
 10.5 \*                      10.5 \*                      10.6 \*                      10.5 \*                      10.7 \*  
 10.5 \*                      10.5 \*                      10.7 \*                      10.3 \*                      10.5 \*  
 beste Teiler 61.0 (25.) 68.2 (28.) 88.5 (23.)  
 Trefferlage 0.06 mm rechts, 0.22 mm hoch  
 Streuwert 0.82, horizontal: 0.88, vertikal: 0.75

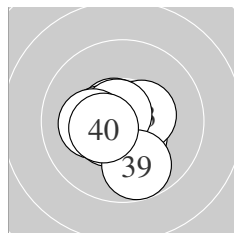

Serie 4:  
 10.5 \*                      10.6 \*                      10.4 \*                      10.6 \*                      10.5 \*  
 10.4 \*                      10.7 \*                      10.2 \*                      9.8 ↓                      10.4 \*  
 beste Teiler 58.4 (37.) 77.1 (32.) 93.1 (34.)  
 Trefferlage 0.44 mm links, 0.39 mm tief  
 Streuwert 1.02, horizontal: 1.04, vertikal: 0.99

Unterschrift des Schützen

Ergebnis: **418.0** (399)  
 Serien: 104.4 105.2 103.6 104.8  
 Zähler: 39 1 0 0 0 0 0 0 0 0  
 Innenzehner: 34  
 weiteste: 279 (17), 245 (26), 235 (28)  
 beste Teiler 30.1 (36.) 38.2 (15.) 46.3 (13.)  
 Trefferlage 0.17 mm rechts, 0.01 mm hoch  
 Streuwert 1.01, horizontal: 1.29, vertikal: 0.61

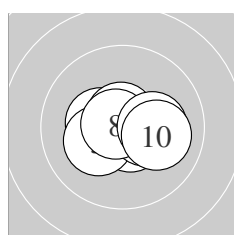
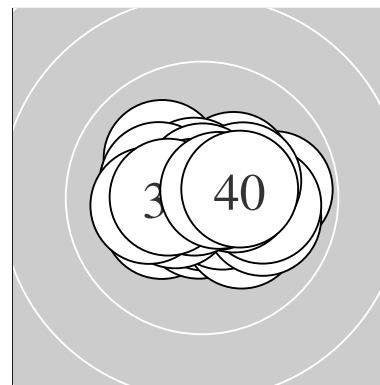

Serie 1:  
 10.4 \*                      10.4 \*                      10.6 \*                      10.6 \*                      10.2 \*  
 10.4 \*                      10.7 \*                      10.8 \*                      10.2 \*                      10.1 →  
 beste Teiler 48.3 (8.) 64.9 (7.) 80.4 (4.)  
 Trefferlage 0.19 mm rechts, 0.19 mm tief  
 Streuwert 1.04, horizontal: 1.39, vertikal: 0.47

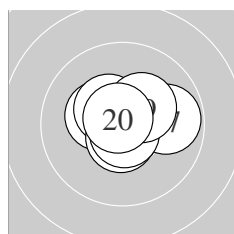

Serie 2:  
 10.3 \*                      10.4 \*                      10.8 \*                      10.7 \*                      10.8 \*  
 10.6 \*                      9.8 →                      10.7 \*                      10.3 \*                      10.8 \*  
 beste Teiler 38.2 (15.) 46.3 (13.) 49.2 (20.)  
 Trefferlage 0.13 mm rechts, 0.04 mm hoch  
 Streuwert 0.95, horizontal: 1.16, vertikal: 0.69

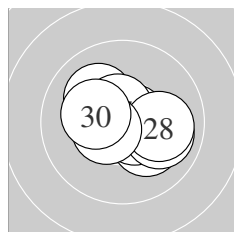

Serie 3:  
 10.1 ↖                      10.7 \*                      10.2 \*                      10.6 \*                      10.7 \*  
 10.0 →                      10.6 \*                      10.0 →                      10.5 \*                      10.2 \*  
 beste Teiler 62.9 (25.) 73.0 (22.) 89.5 (27.)  
 Trefferlage 0.35 mm rechts, 0.06 mm tief  
 Streuwert 1.20, horizontal: 1.48, vertikal: 0.82

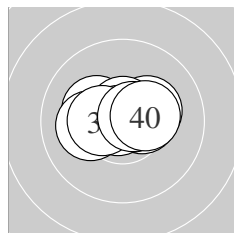

Serie 4:  
 10.2 \*                      10.5 \*                      10.7 \*                      10.3 \*                      10.7 \*  
 10.8 \*                      10.1 ←                      10.4 \*                      10.7 \*                      10.4 \*  
 beste Teiler 30.1 (36.) 55.0 (33.) 62.0 (35.)  
 Trefferlage 0.00 mm , 0.27 mm hoch  
 Streuwert 0.96, horizontal: 1.31, vertikal: 0.31

Unterschrift des Schützen

Meyton Elektronik

Ergebnis:	<b>412.1</b>	(396)
Serien:	103.0	104.2 102.3 102.6
Zähler:	36	4 0 0 0 0 0 0 0 0
Innenzehner:	24	
weiteste:	373	(33), 313 (3), 264 (40)
beste Teiler	26.2	(36.) 31.9 (20.) 34.0 (10.)
Trefferlage	0.26 mm links, 0.23 mm hoch	
Streuwert	1.29, horizontal: 1.49, vertikal: 1.04	

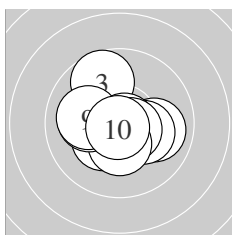
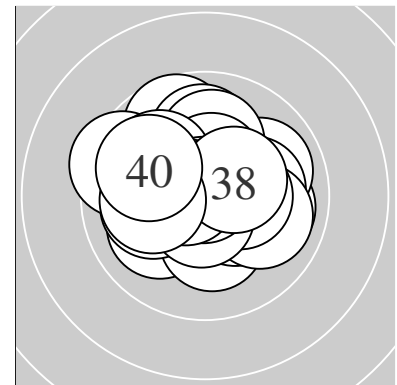

Serie 1:	10.0 →	10.2 *	9.7 ↗	10.8 *	10.3 *
	10.6 *	10.4 *	10.1 ←	10.1 ←	10.8 *
beste Teiler	34.0 (10.) 36.4 (4.) 86.6 (6.)				
Trefferlage	0.16 mm links, 0.10 mm tief				
Streuwert	1.37, horizontal: 1.53, vertikal: 1.19				

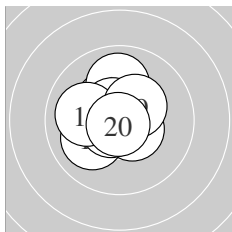

Serie 2:	10.8 *	10.5 *	10.4 *	10.0 ↙	10.0 ↑
	10.7 *	10.6 *	10.0 ←	10.4 *	10.8 *
beste Teiler	31.9 (20.) 43.1 (11.) 71.5 (16.)				
Trefferlage	0.41 mm links, 0.35 mm hoch				
Streuwert	1.08, horizontal: 1.09, vertikal: 1.07				

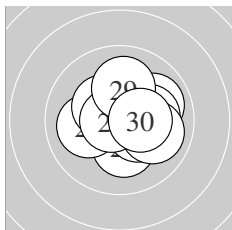

Serie 3:	10.2 *	9.9 ↗	10.1 →	10.4 *	10.0 →
	10.1 ←	10.4 *	10.7 *	10.1 ↑	10.4 *
beste Teiler	57.0 (28.) 146.0 (30.) 146.3 (24.)				
Trefferlage	0.60 mm rechts, 0.07 mm hoch				
Streuwert	1.35, horizontal: 1.54, vertikal: 1.13				

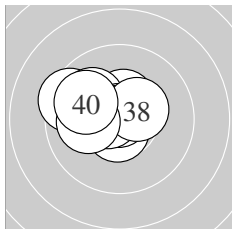

Serie 4:	10.4 *	10.3 *	9.5 ↖	10.0 ↖	10.6 *
	10.8 *	10.6 *	10.4 *	10.1 ←	9.9 ↖
beste Teiler	26.2 (36.) 79.4 (35.) 83.5 (37.)				
Trefferlage	1.09 mm links, 0.60 mm hoch				
Streuwert	1.14, horizontal: 1.44, vertikal: 0.73				

Unterschrift des Schützen

Meyton Elektronik

Ergebnis: **392.8** (373)  
 Serien: 101.0 99.1 97.1 95.6  
 Zähler: 16 22 1 1 0 0 0 0 0 0  
 Innenzehner: 13  
 weiteste: 869 (25), 625 (34), 470 (27)  
 beste Teiler 31.2 (9.) 48.4 (4.) 62.0 (29.)  
 Trefferlage 0.17 mm rechts, 0.80 mm hoch  
 Streuwert 2.28, horizontal: 2.71, vertikal: 1.75

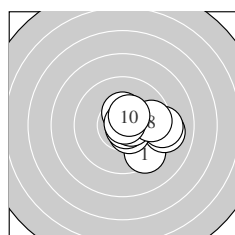
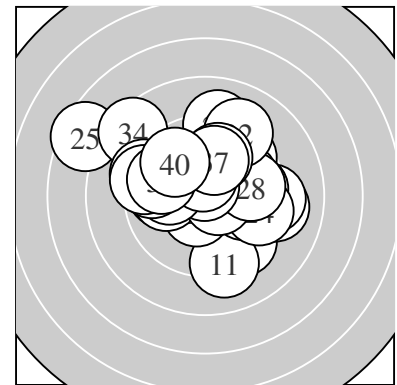

Serie 1:  
 9.4 ↘                      9.1 →                      10.5 \*                      10.8 \*                      10.4 \*  
 10.6 \*                      9.2 →                      9.7 →                      10.8 \*                      10.5 \*  
 beste Teiler 31.2 (9.) 48.4 (4.) 94.0 (6.)  
 Trefferlage 1.73 mm rechts, 0.19 mm tief  
 Streuwert 1.48, horizontal: 1.72, vertikal: 1.19

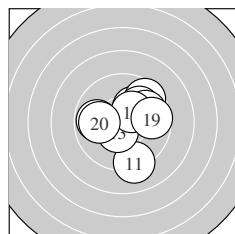

Serie 2:  
 9.1 ↓                      10.2 \*                      10.5 \*                      9.6 ↗                      9.8 ←  
 10.0 ↗                      9.9 ↗                      10.4 \*                      9.7 →                      9.9 ←  
 beste Teiler 117.1 (13.) 148.7 (18.) 200.0 (12.)  
 Trefferlage 0.74 mm rechts, 0.32 mm hoch  
 Streuwert 1.99, horizontal: 2.05, vertikal: 1.93

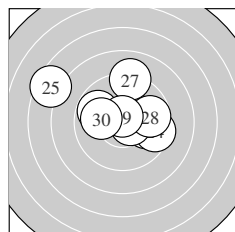

Serie 3:  
 10.3 \*                      9.8 ↖                      9.9 →                      9.5 →                      7.5 ↖  
 10.6 \*                      9.1 ↑                      9.7 →                      10.7 \*                      10.0 ←  
 beste Teiler 62.0 (29.) 91.0 (26.) 173.8 (21.)  
 Trefferlage 0.05 mm links, 1.00 mm hoch  
 Streuwert 2.74, horizontal: 3.41, vertikal: 1.84

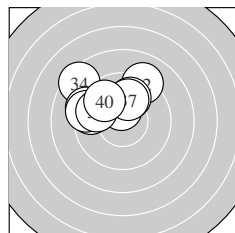

Serie 4:  
 10.5 \*                      9.1 ↗                      9.9 ↑                      8.5 ↖                      9.3 ↖  
 9.5 ←                      10.0 ↑                      9.3 ←                      9.7 ↖                      9.8 ↖  
 beste Teiler 123.7 (31.) 238.4 (37.) 263.4 (33.)  
 Trefferlage 1.73 mm links, 2.08 mm hoch  
 Streuwert 1.91, horizontal: 2.41, vertikal: 1.22

Unterschrift des Schützen