

Ergebnis: **415.8** (396)  
 Serien: 104.9 104.0 103.6 103.3  
 Zaehler: 36 4 0 0 0 0 0 0 0 0  
 Innenzehner: 33  
 weiteste: 323 (20), 281 (22), 281 (31)  
 beste Teiler 10.0 (1.) 31.1 (21.) 52.3 (4.)  
 Trefferlage 0.63 mm links, 0.21 mm hoch  
 Streuwert 1.02, horizontal: 1.10, vertikal: 0.93

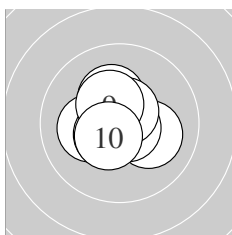

Serie 1:  
 10.9 \*                      10.1 →                      10.2 \*                      10.7 \*                      10.3 \*  
 10.7 \*                      10.5 \*                      10.6 \*                      10.4 \*                      10.5 \*  
 beste Teiler 10.0 (1.) 52.3 (4.) 57.9 (6.)  
 Trefferlage 0.23 mm links, 0.08 mm hoch  
 Streuwert 0.94, horizontal: 1.01, vertikal: 0.87

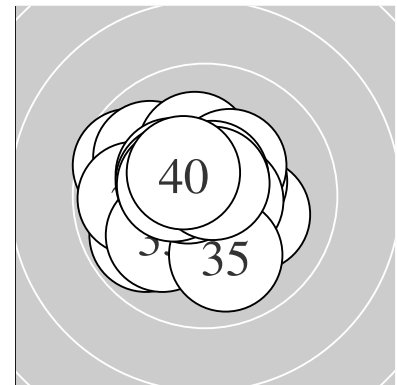
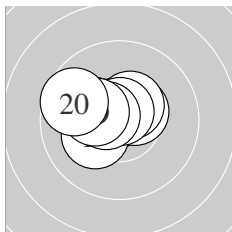

Serie 2:  
 10.7 \*                      10.6 \*                      10.2 \*                      10.5 \*                      10.2 \*  
 10.5 \*                      10.7 \*                      10.6 \*                      10.3 \*                      9.7 ↖  
 beste Teiler 57.0 (17.) 61.4 (11.) 92.2 (12.)  
 Trefferlage 0.86 mm links, 0.45 mm hoch  
 Streuwert 0.96, horizontal: 1.23, vertikal: 0.58

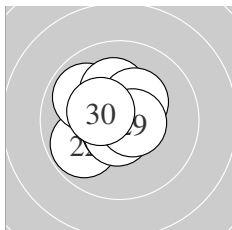

Serie 3:  
 10.8 \*                      9.8 ↙                      10.3 \*                      10.7 \*                      10.6 \*  
 9.9 ↘                      10.2 \*                      10.3 \*                      10.6 \*                      10.4 \*  
 beste Teiler 31.1 (21.) 70.0 (24.) 80.4 (25.)  
 Trefferlage 0.59 mm links, 0.29 mm hoch  
 Streuwert 1.14, horizontal: 1.14, vertikal: 1.15

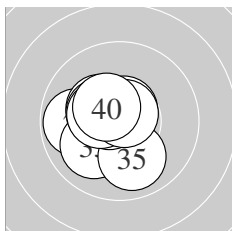

Serie 4:  
 9.8 ←                      10.3 \*                      10.0 ↙                      10.4 \*                      10.0 ↓  
 10.6 \*                      10.6 \*                      10.4 \*                      10.7 \*                      10.5 \*  
 beste Teiler 58.8 (39.) 76.9 (37.) 77.8 (36.)  
 Trefferlage 0.84 mm links, 0.03 mm hoch  
 Streuwert 1.09, horizontal: 1.08, vertikal: 1.10

Unterschrift des Schuetzen

Meyton Elektronik

Ergebnis: **407.3** (393)  
 Serien: 101.3 102.6 102.2 101.2  
 Zaehler: 33 7 0 0 0 0 0 0 0 0  
 Innenzehner: 20  
 weiteste: 448 (29), 350 (36), 327 (33)  
 beste Teiler 7.6 (30.) 53.8 (8.) 61.6 (38.)  
 Trefferlage 0.46 mm links, 0.35 mm hoch  
 Streuwert 1.46, horizontal: 1.67, vertikal: 1.21

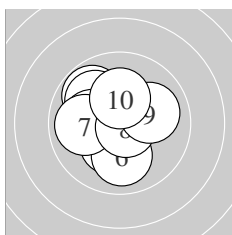
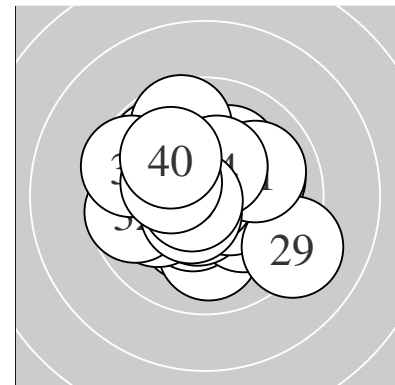

Serie 1:  
 9.8 ↘ 10.3 \* 10.0 ↘ 10.3 \* 10.1 ←  
 10.0 ↓ 9.9 ← 10.7 \* 10.0 → 10.2 \*  
 beste Teiler 53.8 (8.) 167.8 (4.) 169.4 (2.)  
 Trefferlage 0.69 mm links, 0.37 mm hoch  
 Streuwert 1.47, horizontal: 1.46, vertikal: 1.48

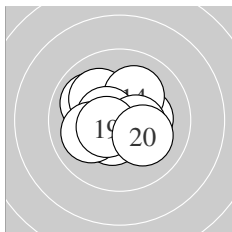

Serie 2:  
 10.3 \* 10.0 ↘ 10.1 ↘ 10.1 ↗ 10.6 \*  
 10.5 \* 10.0 ← 10.4 \* 10.5 \* 10.1 ↘  
 beste Teiler 98.7 (15.) 108.2 (19.) 121.2 (16.)  
 Trefferlage 0.25 mm links, 0.09 mm hoch  
 Streuwert 1.33, horizontal: 1.53, vertikal: 1.10

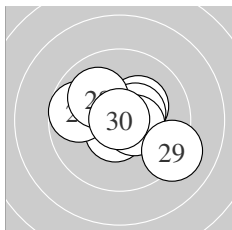

Serie 3:  
 10.5 \* 10.0 ↘ 10.6 \* 10.3 \* 10.5 \*  
 10.5 \* 9.7 ← 10.0 ↘ 9.2 ↘ 10.9 \*  
 beste Teiler 7.6 (30.) 89.8 (23.) 106.8 (21.)  
 Trefferlage 0.14 mm rechts, 0.15 mm hoch  
 Streuwert 1.63, horizontal: 2.02, vertikal: 1.11

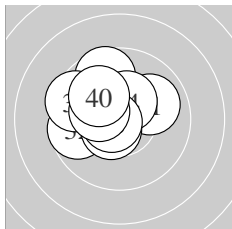

Serie 4:  
 10.0 → 9.7 ← 9.6 ↖ 10.4 \* 10.3 \*  
 9.6 ↘ 10.6 \* 10.7 \* 10.3 \* 10.0 ↘  
 beste Teiler 61.6 (38.) 96.5 (37.) 140.9 (34.)  
 Trefferlage 1.04 mm links, 0.81 mm hoch  
 Streuwert 1.41, horizontal: 1.61, vertikal: 1.17

Unterschrift des Schuetzen

Meyton Elektronik

Ergebnis: **414.3** (398)  
 Serien: 102.9 104.5 103.6 103.3  
 Zaehler: 38 2 0 0 0 0 0 0 0 0  
 Innenzehner: 31  
 weiteste: 320 (24), 262 (9), 240 (37)  
 beste Teiler 15.2 (17.) 29.0 (29.) 41.5 (6.)  
 Trefferlage 0.10 mm links, 0.08 mm tief  
 Streuwert 1.17, horizontal: 1.38, vertikal: 0.90

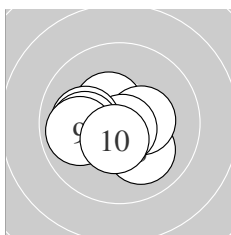
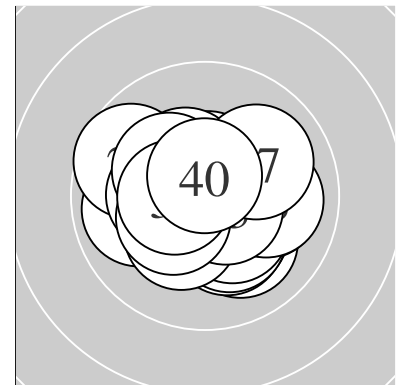

Serie 1:  
 10.3 \*                      10.4 \*                      10.1 ↘                      10.4 \*                      10.4 \*  
 10.8 \*                      10.1 ←                      10.0 ←                      9.9 ←                      10.5 \*  
 beste Teiler 41.5 (6.) 109.1 (10.) 130.0 (4.)  
 Trefferlage 0.50 mm links, 0.29 mm tief  
 Streuwert 1.25, horizontal: 1.55, vertikal: 0.86

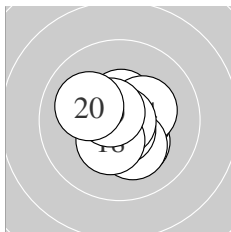

Serie 2:  
 10.3 \*                      10.5 \*                      10.5 \*                      10.3 \*                      10.2 \*  
 10.7 \*                      10.9 \*                      10.4 \*                      10.6 \*                      10.1 ↗  
 beste Teiler 15.2 (17.) 64.9 (16.) 77.3 (19.)  
 Trefferlage 0.17 mm rechts, 0.18 mm tief  
 Streuwert 1.02, horizontal: 1.04, vertikal: 1.00

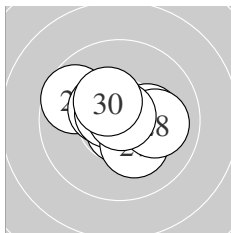

Serie 3:  
 10.2 \*                      10.7 \*                      10.6 \*                      9.7 ↖                      10.4 \*  
 10.6 \*                      10.2 \*                      10.0 →                      10.8 \*                      10.4 \*  
 beste Teiler 29.0 (29.) 58.1 (22.) 81.8 (26.)  
 Trefferlage 0.09 mm links, 0.24 mm hoch  
 Streuwert 1.23, horizontal: 1.51, vertikal: 0.86

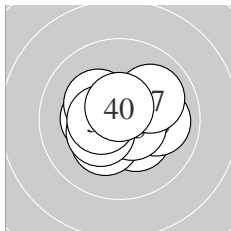

Serie 4:  
 10.3 \*                      10.3 \*                      10.0 →                      10.3 \*                      10.6 \*  
 10.3 \*                      10.0 ↗                      10.4 \*                      10.5 \*                      10.6 \*  
 beste Teiler 79.0 (40.) 92.1 (35.) 119.1 (39.)  
 Trefferlage 0.01 mm links, 0.09 mm tief  
 Streuwert 1.24, horizontal: 1.49, vertikal: 0.92

Unterschrift des Schuetzen

Meyton Elektronik

Ergebnis: **418.4** (400)  
 Serien: 105.3 104.4 104.1 104.6  
 Zaehler: 40 0 0 0 0 0 0 0 0 0  
 Innenzehner: 36  
 weiteste: 242 (13), 228 (17), 215 (21)  
 beste Teiler 37.1 (16.) 39.8 (4.) 51.6 (6.)  
 Trefferlage 0.00 mm , 0.40 mm hoch  
 Streuwert 0.91, horizontal: 1.09, vertikal: 0.69

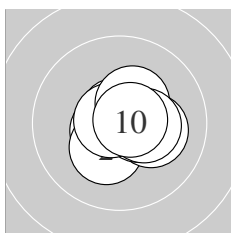
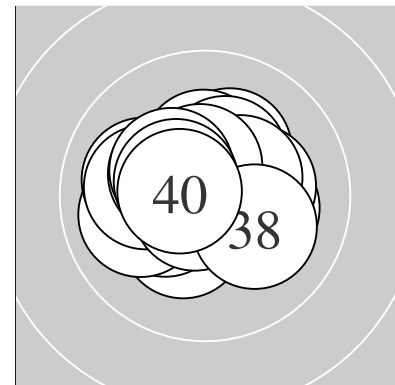

Serie 1:  
 10.6 \* 10.3 \* 10.2 \* 10.8 \* 10.5 \*  
 10.7 \* 10.7 \* 10.4 \* 10.4 \* 10.7 \*  
 beste Teiler 39.8 (4.) 51.6 (6.) 54.7 (7.)  
 Trefferlage 0.34 mm rechts, 0.01 mm tief  
 Streuwert 0.84, horizontal: 0.96, vertikal: 0.70

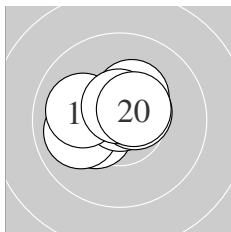

Serie 2:  
 10.3 \* 10.3 \* 10.0 ← 10.7 \* 10.7 \*  
 10.8 \* 10.0 ← 10.5 \* 10.6 \* 10.5 \*  
 beste Teiler 37.1 (16.) 63.2 (14.) 72.7 (15.)  
 Trefferlage 0.38 mm links, 0.42 mm hoch  
 Streuwert 0.97, horizontal: 1.21, vertikal: 0.64

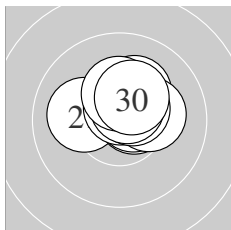

Serie 3:  
 10.1 ← 10.6 \* 10.2 \* 10.6 \* 10.7 \*  
 10.2 \* 10.5 \* 10.6 \* 10.3 \* 10.3 \*  
 beste Teiler 75.3 (25.) 88.3 (24.) 89.2 (22.)  
 Trefferlage 0.42 mm rechts, 0.80 mm hoch  
 Streuwert 0.82, horizontal: 1.03, vertikal: 0.54

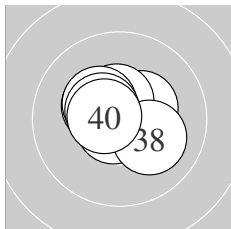

Serie 4:  
 10.6 \* 10.5 \* 10.4 \* 10.4 \* 10.7 \*  
 10.5 \* 10.3 \* 10.1 ↘ 10.5 \* 10.6 \*  
 beste Teiler 58.2 (35.) 87.4 (31.) 93.5 (40.)  
 Trefferlage 0.34 mm links, 0.39 mm hoch  
 Streuwert 0.89, horizontal: 1.06, vertikal: 0.68

Unterschrift des Schuetzen

Meyton Elektronik

Ergebnis: **420.9** (400)  
 Serien: 105.9 105.0 104.9 105.1  
 Zaehler: 40 0 0 0 0 0 0 0 0 0  
 Innenzehner: 38  
 weiteste: 236 (40), 205 (23), 186 (15)  
 beste Teiler 17.0 (38.) 18.9 (37.) 24.1 (9.)  
 Trefferlage 0.02 mm rechts, 0.02 mm hoch  
 Streuwert 0.85, horizontal: 0.91, vertikal: 0.79

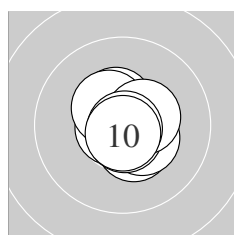
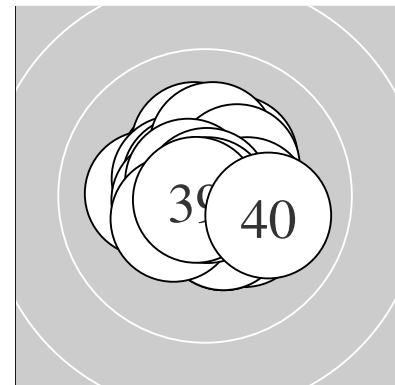

Serie 1:  
 10.4 \*                      10.7 \*                      10.8 \*                      10.4 \*                      10.4 \*  
 10.4 \*                      10.7 \*                      10.4 \*                      10.9 \*                      10.8 \*  
 beste Teiler 24.1 (9.) 48.0 (10.) 50.6 (3.)  
 Trefferlage 0.16 mm rechts, 0.00 mm  
 Streuwert 0.73, horizontal: 0.68, vertikal: 0.78

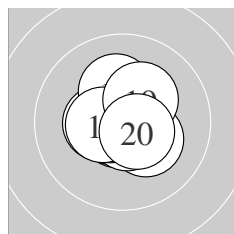

Serie 2:  
 10.7 \*                      10.3 \*                      10.7 \*                      10.4 \*                      10.2 \*  
 10.7 \*                      10.7 \*                      10.5 \*                      10.3 \*                      10.5 \*  
 beste Teiler 55.7 (11.) 61.4 (13.) 70.3 (16.)  
 Trefferlage 0.08 mm links, 0.02 mm tief  
 Streuwert 0.92, horizontal: 0.94, vertikal: 0.90

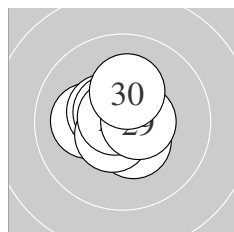

Serie 3:  
 10.8 \*                      10.4 \*                      10.1 ←                      10.5 \*                      10.6 \*  
 10.6 \*                      10.4 \*                      10.7 \*                      10.6 \*                      10.2 \*  
 beste Teiler 41.0 (21.) 53.0 (28.) 92.9 (25.)  
 Trefferlage 0.24 mm links, 0.28 mm hoch  
 Streuwert 0.89, horizontal: 0.91, vertikal: 0.87

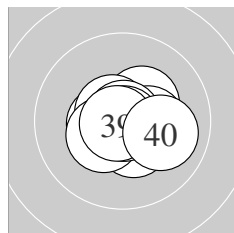

Serie 4:  
 10.5 \*                      10.3 \*                      10.6 \*                      10.3 \*                      10.4 \*  
 10.4 \*                      10.9 \*                      10.9 \*                      10.8 \*                      10.0 →  
 beste Teiler 17.0 (38.) 18.9 (37.) 35.8 (39.)  
 Trefferlage 0.25 mm rechts, 0.15 mm tief  
 Streuwert 0.92, horizontal: 1.13, vertikal: 0.64

Unterschrift des Schuetzen

Meyton Elektronik

Ergebnis: **409.7** (391)  
 Serien: 100.9 103.2 101.7 103.9  
 Zaehler: 32 7 1 0 0 0 0 0 0 0  
 Innenzehner: 27  
 weiteste: 581 (3), 482 (22), 461 (13)  
 beste Teiler 34.4 (16.) 48.1 (33.) 49.5 (30.)  
 Trefferlage 0.51 mm links, 0.23 mm hoch  
 Streuwert 1.50, horizontal: 1.69, vertikal: 1.29

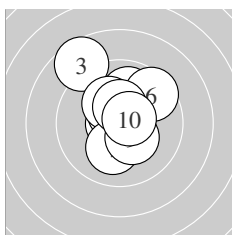
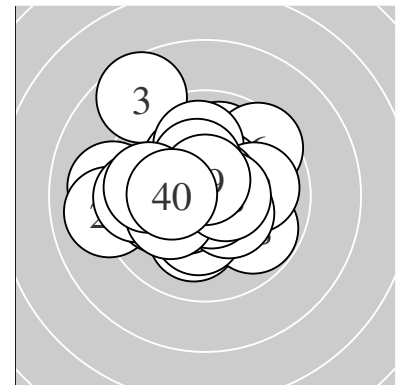

Serie 1:  
 10.7 \*                      10.6 \*                      8.6 ↖                      9.9 ↑                      10.2 \*  
 9.5 ↗                      10.1 ↓                      10.4 \*                      10.3 \*                      10.6 \*  
 beste Teiler 58.2 (1.) 87.2 (10.) 93.0 (2.)  
 Trefferlage 0.04 mm links, 1.06 mm hoch  
 Streuwert 1.75, horizontal: 1.51, vertikal: 1.97

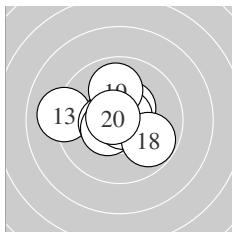

Serie 2:  
 10.6 \*                      10.5 \*                      9.1 ←                      10.5 \*                      10.5 \*  
 10.8 \*                      10.7 \*                      9.8 ↘                      10.0 ↑                      10.7 \*  
 beste Teiler 34.4 (16.) 55.4 (17.) 60.9 (20.)  
 Trefferlage 0.45 mm links, 0.19 mm hoch  
 Streuwert 1.48, horizontal: 1.79, vertikal: 1.07

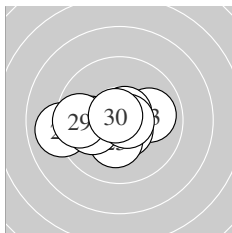

Serie 3:  
 10.0 ←                      9.0 ←                      10.0 →                      10.6 \*                      10.3 \*  
 10.7 \*                      10.0 ←                      10.7 \*                      9.6 ←                      10.8 \*  
 beste Teiler 49.5 (30.) 62.6 (28.) 69.0 (26.)  
 Trefferlage 0.93 mm links, 0.30 mm tief  
 Streuwert 1.61, horizontal: 2.17, vertikal: 0.69

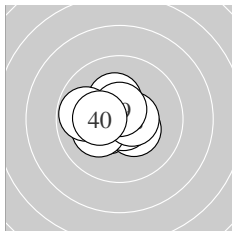

Serie 4:  
 10.5 \*                      10.4 \*                      10.8 \*                      10.5 \*                      10.2 \*  
 10.3 \*                      9.8 ←                      10.5 \*                      10.6 \*                      10.3 \*  
 beste Teiler 48.1 (33.) 80.0 (39.) 102.0 (38.)  
 Trefferlage 0.62 mm links, 0.01 mm tief  
 Streuwert 1.06, horizontal: 1.28, vertikal: 0.78

Unterschrift des Schuetzen

Meyton Elektronik

Ergebnis: **409.9** (393)  
 Serien: 103.1 101.1 103.8 101.9  
 Zaehler: 33 7 0 0 0 0 0 0 0 0  
 Innenzehner: 25  
 weiteste: 336 (20), 325 (22), 321 (12)  
 beste Teiler 5.8 (6.) 35.5 (26.) 37.0 (21.)  
 Trefferlage 0.38 mm links, 0.32 mm tief  
 Streuwert 1.34, horizontal: 1.73, vertikal: 0.78

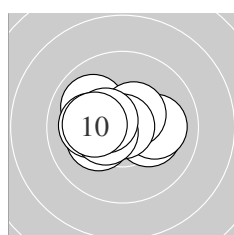
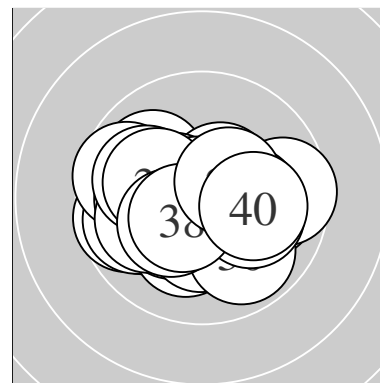

Serie 1:  
 10.2 \*                      10.0 ↘                      10.1 →                      10.5 \*                      10.2 \*  
 10.9 \*                      10.1 ←                      10.5 \*                      10.4 \*                      10.2 \*  
 beste Teiler 5.8 (6.) 117.0 (4.) 122.7 (8.)  
 Trefferlage 0.54 mm links, 0.15 mm hoch  
 Streuwert 1.24, horizontal: 1.63, vertikal: 0.65

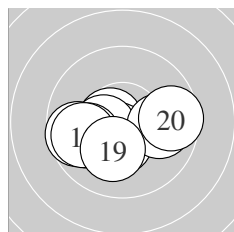

Serie 2:  
 10.4 \*                      9.7 ←                      10.6 \*                      10.6 \*                      10.4 \*  
 9.9 ←                      9.9 →                      9.8 ←                      10.2 \*                      9.6 →  
 beste Teiler 85.8 (13.) 95.2 (14.) 135.8 (15.)  
 Trefferlage 0.57 mm links, 0.70 mm tief  
 Streuwert 1.57, horizontal: 2.12, vertikal: 0.65

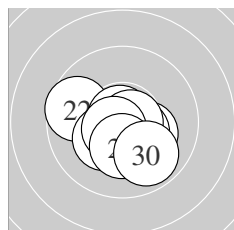

Serie 3:  
 10.8 \*                      9.7 ↖                      10.2 \*                      10.5 \*                      10.3 \*  
 10.8 \*                      10.7 \*                      10.6 \*                      10.3 \*                      9.9 ↘  
 beste Teiler 35.5 (26.) 37.0 (21.) 56.0 (27.)  
 Trefferlage 0.07 mm links, 0.56 mm tief  
 Streuwert 1.20, horizontal: 1.43, vertikal: 0.93

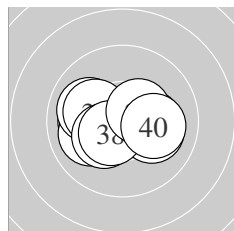

Serie 4:  
 10.1 ←                      10.1 →                      10.0 ↙                      10.0 ↖                      10.2 \*  
 10.2 \*                      10.3 \*                      10.5 \*                      10.4 \*                      10.1 →  
 beste Teiler 115.9 (38.) 129.3 (39.) 164.2 (37.)  
 Trefferlage 0.36 mm links, 0.17 mm tief  
 Streuwert 1.44, horizontal: 1.91, vertikal: 0.68

Unterschrift des Schuetzen

Meyton Elektronik

Ergebnis: **411.9** (394)  
 Serien: 105.8 102.0 103.3 100.8  
 Zaehler: 34 6 0 0 0 0 0 0 0 0  
 Innenzehner: 27  
 weiteste: 406 (33), 353 (20), 331 (22)  
 beste Teiler 11.3 (3.) 36.8 (4.) 39.1 (29.)  
 Trefferlage 0.48 mm links, 0.14 mm tief  
 Streuwert 1.30, horizontal: 1.41, vertikal: 1.17

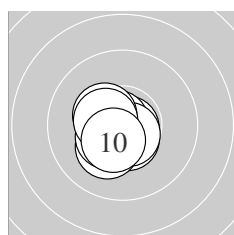
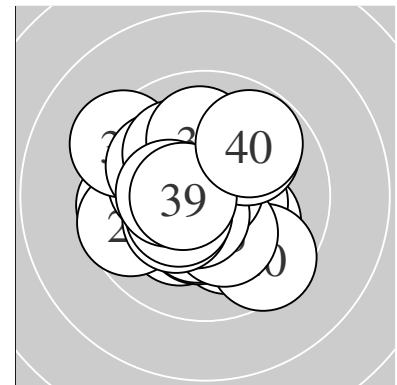

Serie 1:  
 10.6 \*                      10.2 \*                      10.9 \*                      10.8 \*                      10.4 \*  
 10.8 \*                      10.7 \*                      10.4 \*                      10.5 \*                      10.5 \*  
 beste Teiler 11.3 (3.) 36.8 (4.) 46.5 (6.)  
 Trefferlage 0.46 mm links, 0.40 mm tief  
 Streuwert 0.68, horizontal: 0.67, vertikal: 0.70

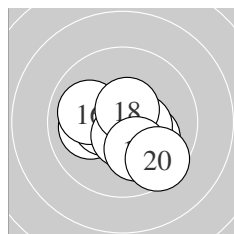

Serie 2:  
 10.2 \*                      10.1 ↘                      10.4 \*                      10.0 ←                      10.5 \*  
 10.0 ↙                      10.6 \*                      10.6 \*                      10.1 ↓                      9.5 ↘  
 beste Teiler 93.6 (18.) 94.0 (17.) 125.3 (15.)  
 Trefferlage 0.24 mm rechts, 0.67 mm tief  
 Streuwert 1.40, horizontal: 1.67, vertikal: 1.07

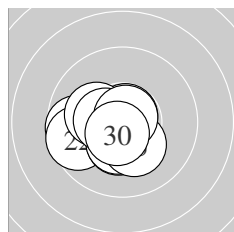

Serie 3:  
 9.7 ←                      9.6 ←                      10.4 \*                      10.4 \*                      10.3 \*  
 10.8 \*                      10.2 \*                      10.5 \*                      10.8 \*                      10.6 \*  
 beste Teiler 39.1 (29.) 48.3 (26.) 87.6 (30.)  
 Trefferlage 0.90 mm links, 0.52 mm tief  
 Streuwert 1.15, horizontal: 1.39, vertikal: 0.84

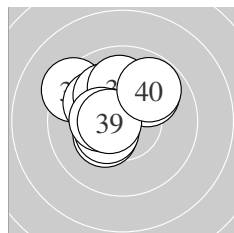

Serie 4:  
 9.9 ↗                      10.3 \*                      9.3 ↖                      10.0 ↖                      10.1 ↖  
 10.4 \*                      10.0 ↑                      10.4 \*                      10.6 \*                      9.8 ↗  
 beste Teiler 92.0 (39.) 131.4 (36.) 150.4 (38.)  
 Trefferlage 0.79 mm links, 1.00 mm hoch  
 Streuwert 1.45, horizontal: 1.60, vertikal: 1.28

Unterschrift des Schuetzen

Meyton Elektronik



Ergebnis: **412.2** (391)  
 Serien: 102.6 103.1 103.1 103.4  
 Zaehler: 31 9 0 0 0 0 0 0 0 0  
 Innenzehner: 26  
 weiteste: 386 (11), 362 (6), 309 (30)  
 beste Teiler 14.8 (7.) 17.2 (39.) 55.0 (15.)  
 Trefferlage 0.45 mm links, 0.03 mm tief  
 Streuwert 1.30, horizontal: 1.57, vertikal: 0.96

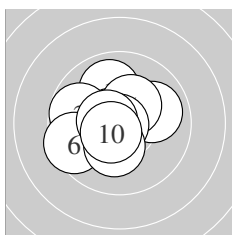
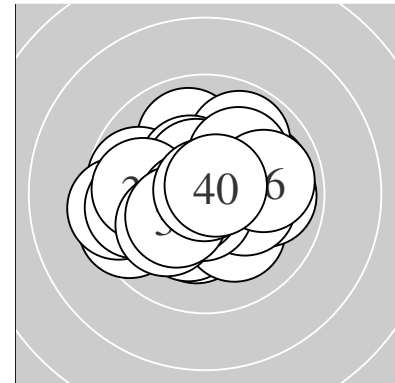

Serie 1:  
 9.9 ↗ 10.7 \* 9.8 ↖ 10.0 → 10.3 \*  
 9.5 ↖ 10.9 \* 10.6 \* 10.3 \* 10.6 \*  
 beste Teiler 14.8 (7.) 68.8 (2.) 91.9 (10.)  
 Trefferlage 0.64 mm links, 0.18 mm hoch  
 Streuwert 1.45, horizontal: 1.63, vertikal: 1.24

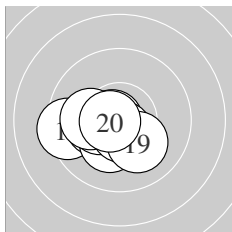

Serie 2:  
 9.4 ↖ 10.5 \* 10.3 \* 10.3 \* 10.7 \*  
 10.4 \* 10.1 ↖ 10.6 \* 10.1 ↘ 10.7 \*  
 beste Teiler 55.0 (15.) 71.5 (20.) 87.6 (18.)  
 Trefferlage 1.07 mm links, 0.57 mm tief  
 Streuwert 1.06, horizontal: 1.37, vertikal: 0.61

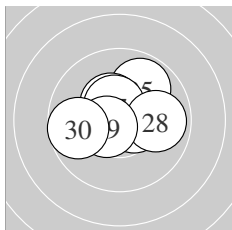

Serie 3:  
 10.6 \* 10.5 \* 10.6 \* 10.5 \* 9.9 ↗  
 10.4 \* 10.5 \* 9.9 → 10.5 \* 9.7 ↖  
 beste Teiler 94.0 (21.) 94.3 (23.) 103.1 (24.)  
 Trefferlage 0.06 mm links, 0.36 mm hoch  
 Streuwert 1.31, horizontal: 1.62, vertikal: 0.90

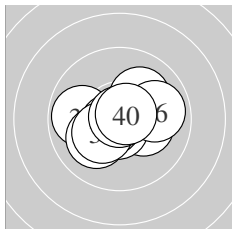

Serie 4:  
 9.9 ↖ 10.2 \* 10.1 ↖ 10.7 \* 10.1 ↗  
 9.9 → 10.6 \* 10.3 \* 10.9 \* 10.7 \*  
 beste Teiler 17.2 (39.) 59.8 (40.) 71.3 (34.)  
 Trefferlage 0.02 mm links, 0.10 mm tief  
 Streuwert 1.31, horizontal: 1.65, vertikal: 0.86

Unterschrift des Schuetzen

Ergebnis: **417.8** (400)  
 Serien: 104.5 104.2 104.2 104.9  
 Zaehler: 40 0 0 0 0 0 0 0 0 0  
 Innenzehner: 37  
 weiteste: 233 (16), 209 (35), 203 (31)  
 beste Teiler 34.9 (37.) 53.1 (36.) 56.0 (4.)  
 Trefferlage 0.04 mm rechts, 0.02 mm hoch  
 Streuwert 0.96, horizontal: 1.18, vertikal: 0.69

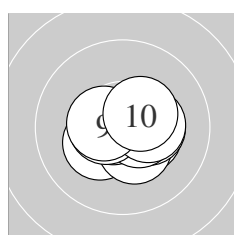
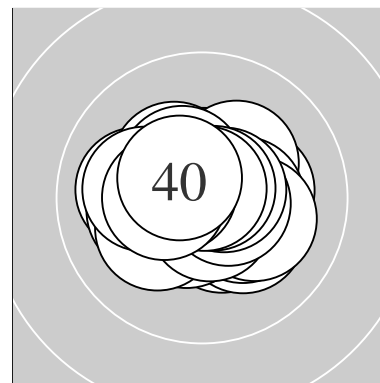

Serie 1:  
 10.4 \*                      10.3 \*                      10.4 \*                      10.7 \*                      10.3 \*  
 10.6 \*                      10.6 \*                      10.3 \*                      10.5 \*                      10.4 \*  
 beste Teiler 56.0 (4.) 99.0 (7.) 99.8 (6.)  
 Trefferlage 0.31 mm rechts, 0.16 mm tief  
 Streuwert 0.93, horizontal: 1.18, vertikal: 0.57

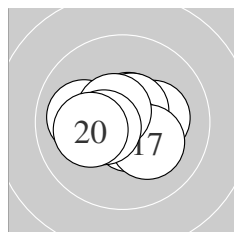

Serie 2:  
 10.7 \*                      10.2 \*                      10.6 \*                      10.6 \*                      10.6 \*  
 10.0 ←                      10.2 \*                      10.6 \*                      10.5 \*                      10.2 \*  
 beste Teiler 75.2 (11.) 81.0 (13.) 82.7 (15.)  
 Trefferlage 0.10 mm links, 0.06 mm hoch  
 Streuwert 1.08, horizontal: 1.36, vertikal: 0.69

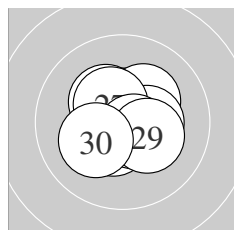

Serie 3:  
 10.5 \*                      10.7 \*                      10.6 \*                      10.2 \*                      10.4 \*  
 10.3 \*                      10.4 \*                      10.6 \*                      10.3 \*                      10.2 \*  
 beste Teiler 71.5 (22.) 87.3 (28.) 100.0 (23.)  
 Trefferlage 0.04 mm rechts, 0.15 mm hoch  
 Streuwert 1.04, horizontal: 1.10, vertikal: 0.97

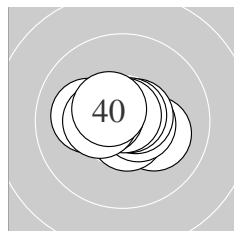

Serie 4:  
 10.1 ↘                      10.6 \*                      10.6 \*                      10.6 \*                      10.1 ←  
 10.7 \*                      10.8 \*                      10.5 \*                      10.4 \*                      10.5 \*  
 beste Teiler 34.9 (37.) 53.1 (36.) 80.9 (32.)  
 Trefferlage 0.08 mm links, 0.06 mm hoch  
 Streuwert 0.92, horizontal: 1.20, vertikal: 0.49

Unterschrift des Schuetzen

Meyton Elektronik

Ergebnis: **421.6** (400)  
 Serien: 105.8 104.7 105.5 105.6  
 Zaehler: 40 0 0 0 0 0 0 0 0 0  
 Innenzehner: 40  
 weiteste: 199 (4), 198 (20), 187 (12)  
 beste Teiler 24.5 (36.) 34.2 (3.) 35.8 (34.)  
 Trefferlage 0.12 mm links, 0.20 mm hoch  
 Streuwert 0.80, horizontal: 0.97, vertikal: 0.58

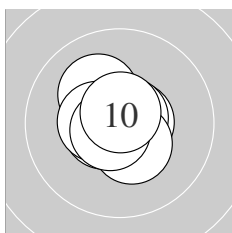
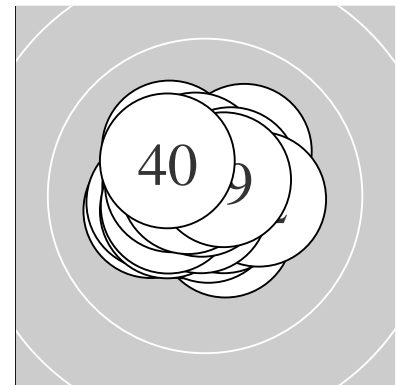

Serie 1:  
 10.6 \* 10.6 \* 10.8 \* 10.2 \* 10.6 \*  
 10.7 \* 10.5 \* 10.4 \* 10.7 \* 10.7 \*  
 beste Teiler 34.2 (3.) 54.9 (6.) 60.2 (10.)  
 Trefferlage 0.29 mm links, 0.12 mm hoch  
 Streuwert 0.73, horizontal: 0.75, vertikal: 0.71

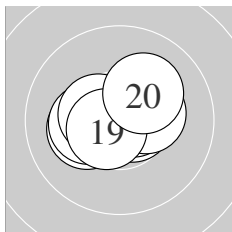

Serie 2:  
 10.4 \* 10.2 \* 10.7 \* 10.3 \* 10.5 \*  
 10.7 \* 10.7 \* 10.4 \* 10.6 \* 10.2 \*  
 beste Teiler 53.3 (13.) 70.5 (16.) 75.4 (17.)  
 Trefferlage 0.04 mm rechts, 0.16 mm hoch  
 Streuwert 0.99, horizontal: 1.27, vertikal: 0.59

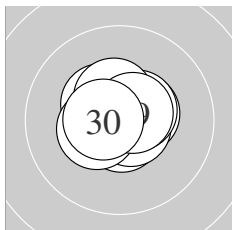

Serie 3:  
 10.7 \* 10.5 \* 10.6 \* 10.4 \* 10.7 \*  
 10.5 \* 10.4 \* 10.5 \* 10.6 \* 10.6 \*  
 beste Teiler 65.9 (21.) 70.2 (25.) 83.2 (29.)  
 Trefferlage 0.07 mm links, 0.23 mm hoch  
 Streuwert 0.76, horizontal: 0.89, vertikal: 0.60

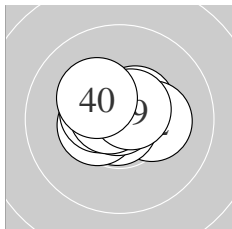

Serie 4:  
 10.5 \* 10.2 \* 10.7 \* 10.8 \* 10.4 \*  
 10.9 \* 10.5 \* 10.7 \* 10.6 \* 10.3 \*  
 beste Teiler 24.5 (36.) 35.8 (34.) 64.8 (38.)  
 Trefferlage 0.17 mm links, 0.29 mm hoch  
 Streuwert 0.78, horizontal: 1.00, vertikal: 0.47

Unterschrift des Schuetzen

Ergebnis: **416.2** (394)  
 Serien: 103.3 105.0 104.1 103.8  
 Zaehler: 34 6 0 0 0 0 0 0 0 0  
 Innenzehner: 33  
 weiteste: 405 (24), 279 (28), 265 (1)  
 beste Teiler 15.8 (30.) 21.5 (19.) 21.9 (17.)  
 Trefferlage 0.52 mm links, 0.15 mm hoch  
 Streuwert 1.08, horizontal: 1.31, vertikal: 0.78

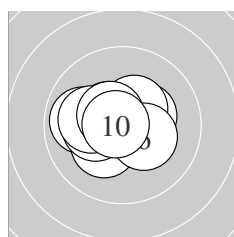
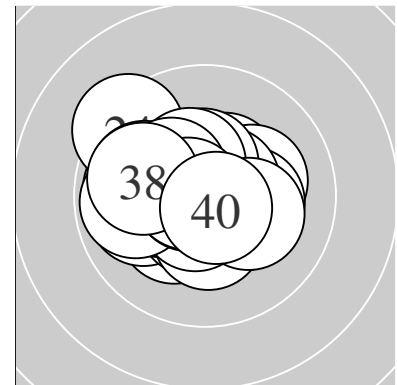

Serie 1:  
 9.9 ← 10.2 \* 10.2 \* 10.4 \* 10.4 \*  
 10.3 \* 10.5 \* 10.1 ← 10.5 \* 10.8 \*  
 beste Teiler 47.3 (10.) 106.5 (9.) 116.2 (7.)  
 Trefferlage 0.64 mm links, 0.16 mm hoch  
 Streuwert 1.13, horizontal: 1.42, vertikal: 0.72

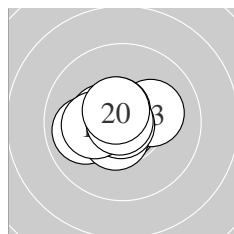

Serie 2:  
 9.9 ← 10.8 \* 10.2 \* 10.6 \* 10.4 \*  
 10.5 \* 10.9 \* 10.2 \* 10.9 \* 10.6 \*  
 beste Teiler 21.5 (19.) 21.9 (17.) 32.0 (12.)  
 Trefferlage 0.53 mm links, 0.02 mm hoch  
 Streuwert 0.93, horizontal: 1.18, vertikal: 0.58

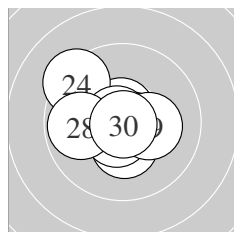

Serie 3:  
 10.8 \* 10.7 \* 10.7 \* 9.3 ↘ 10.8 \*  
 10.3 \* 10.6 \* 9.8 ← 10.2 \* 10.9 \*  
 beste Teiler 15.8 (30.) 42.5 (25.) 50.2 (21.)  
 Trefferlage 0.37 mm links, 0.01 mm hoch  
 Streuwert 1.30, horizontal: 1.48, vertikal: 1.09

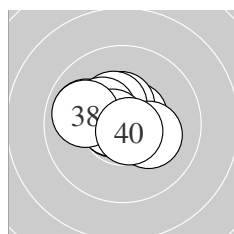

Serie 4:  
 9.9 ← 10.7 \* 10.6 \* 10.4 \* 10.4 \*  
 10.3 \* 10.7 \* 9.9 ← 10.2 \* 10.7 \*  
 beste Teiler 63.0 (32.) 65.1 (40.) 68.5 (37.)  
 Trefferlage 0.53 mm links, 0.43 mm hoch  
 Streuwert 1.06, horizontal: 1.33, vertikal: 0.69

Unterschrift des Schuetzen

Meyton Elektronik

Ergebnis: **414.7** (397)  
 Serien: 103.7 102.1 105.1 103.8  
 Zaehler: 37 3 0 0 0 0 0 0 0 0  
 Innenzehner: 35  
 weiteste: 378 (11), 276 (25), 273 (15)  
 beste Teiler 26.0 (34.) 43.4 (29.) 51.0 (16.)  
 Trefferlage 0.82 mm links, 0.49 mm tief  
 Streuwert 0.91, horizontal: 0.90, vertikal: 0.91

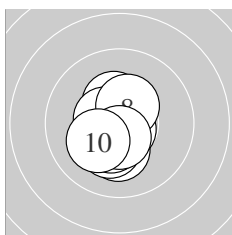
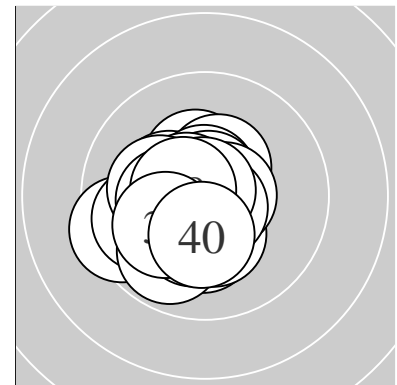

Serie 1:  
 10.2 \*                      10.2 \*                      10.2 \*                      10.7 \*                      10.4 \*  
 10.4 \*                      10.5 \*                      10.4 \*                      10.5 \*                      10.2 \*  
 beste Teiler 54.2 (4.) 101.0 (9.) 106.6 (7.)  
 Trefferlage 0.47 mm links, 0.57 mm tief  
 Streuwert 0.96, horizontal: 0.68, vertikal: 1.17

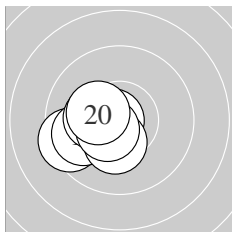

Serie 2:  
 9.4 ←                      10.1 ←                      10.2 \*                      10.4 \*                      9.9 ←  
 10.7 \*                      10.3 \*                      10.3 \*                      10.5 \*                      10.3 \*  
 beste Teiler 51.0 (16.) 108.2 (19.) 136.4 (14.)  
 Trefferlage 1.58 mm links, 0.56 mm tief  
 Streuwert 0.82, horizontal: 0.96, vertikal: 0.66

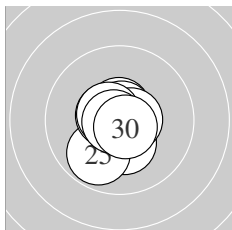

Serie 3:  
 10.6 \*                      10.4 \*                      10.7 \*                      10.3 \*                      9.8 ↙  
 10.6 \*                      10.6 \*                      10.6 \*                      10.8 \*                      10.7 \*  
 beste Teiler 43.4 (29.) 52.8 (23.) 63.1 (30.)  
 Trefferlage 0.22 mm links, 0.38 mm tief  
 Streuwert 0.88, horizontal: 0.69, vertikal: 1.04

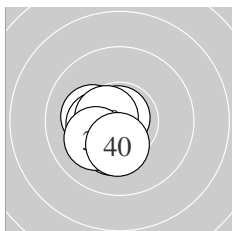

Serie 4:  
 10.5 \*                      10.2 \*                      10.5 \*                      10.8 \*                      10.3 \*  
 10.2 \*                      10.3 \*                      10.6 \*                      10.1 ←                      10.3 \*  
 beste Teiler 26.0 (34.) 96.3 (38.) 113.7 (33.)  
 Trefferlage 1.03 mm links, 0.46 mm tief  
 Streuwert 0.74, horizontal: 0.68, vertikal: 0.80

Unterschrift des Schuetzen

Meyton Elektronik

Ergebnis: **420.2** (400)  
 Serien: 105.3 105.4 105.3 104.2  
 Zaehler: 40 0 0 0 0 0 0 0 0 0  
 Innenzehner: 39  
 weiteste: 248 (38), 193 (39), 190 (3)  
 beste Teiler 8.2 (5.) 10.8 (28.) 32.0 (24.)  
 Trefferlage 0.01 mm links, 0.27 mm hoch  
 Streuwert 0.89, horizontal: 0.89, vertikal: 0.89

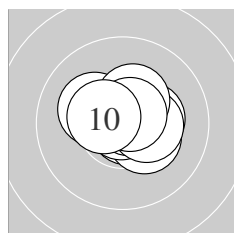
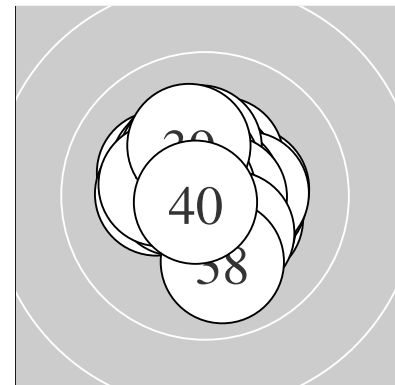

Serie 1:  
 10.8 \* 10.3 \* 10.2 \* 10.3 \* 10.9 \*  
 10.8 \* 10.4 \* 10.4 \* 10.7 \* 10.5 \*  
 beste Teiler 8.2 (5.) 38.8 (1.) 49.9 (6.)  
 Trefferlage 0.31 mm rechts, 0.24 mm hoch  
 Streuwert 0.87, horizontal: 1.07, vertikal: 0.61

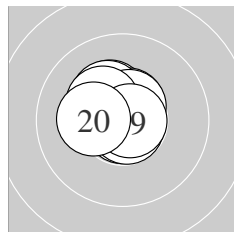

Serie 2:  
 10.7 \* 10.8 \* 10.3 \* 10.6 \* 10.3 \*  
 10.6 \* 10.3 \* 10.8 \* 10.8 \* 10.2 \*  
 beste Teiler 39.2 (12.) 45.1 (19.) 50.2 (18.)  
 Trefferlage 0.34 mm links, 0.55 mm hoch  
 Streuwert 0.73, horizontal: 0.77, vertikal: 0.69

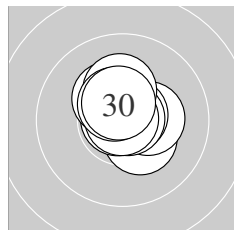

Serie 3:  
 10.3 \* 10.3 \* 10.7 \* 10.8 \* 10.8 \*  
 10.3 \* 10.2 \* 10.9 \* 10.5 \* 10.5 \*  
 beste Teiler 10.8 (28.) 32.0 (24.) 33.2 (25.)  
 Trefferlage 0.13 mm rechts, 0.47 mm hoch  
 Streuwert 0.78, horizontal: 0.73, vertikal: 0.82

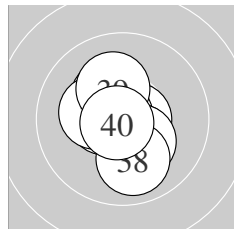

Serie 4:  
 10.7 \* 10.5 \* 10.8 \* 10.3 \* 10.3 \*  
 10.3 \* 10.3 \* 10.0 ↓ 10.2 \* 10.8 \*  
 beste Teiler 41.8 (40.) 46.0 (33.) 74.0 (31.)  
 Trefferlage 0.16 mm links, 0.15 mm tief  
 Streuwert 1.12, horizontal: 0.94, vertikal: 1.27

Unterschrift des Schuetzen

Meyton Elektronik

Ergebnis: **412.2** (392)  
 Serien: 103.4 103.9 103.2 101.7  
 Zaehler: 32 8 0 0 0 0 0 0 0 0  
 Innenzehner: 25  
 weiteste: 343 (36), 339 (32), 329 (30)  
 beste Teiler 31.0 (12.) 36.0 (23.) 37.2 (2.)  
 Trefferlage 0.03 mm links, 0.14 mm tief  
 Streuwert 1.33, horizontal: 1.65, vertikal: 0.88

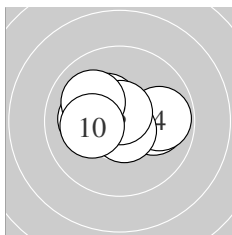
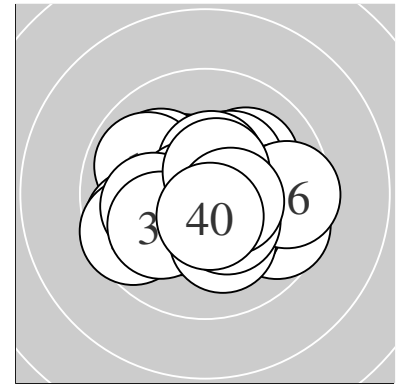

Serie 1:  
 10.7 \*                      10.8 \*                      10.0 →                      9.8 →                      10.7 \*  
 10.4 \*                      10.1 ←                      10.7 \*                      10.0 ↖                      10.2 \*  
 beste Teiler 37.2 (2.) 60.2 (8.) 66.8 (1.)  
 Trefferlage 0.19 mm links, 0.28 mm hoch  
 Streuwert 1.27, horizontal: 1.68, vertikal: 0.62

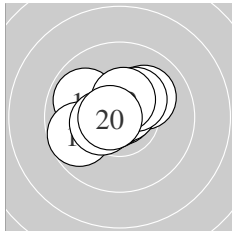

Serie 2:  
 9.9 ↖                      10.8 \*                      9.7 ↖                      10.8 \*                      10.4 \*  
 10.1 ↗                      10.7 \*                      10.3 \*                      10.5 \*                      10.7 \*  
 beste Teiler 31.0 (12.) 49.1 (14.) 62.1 (17.)  
 Trefferlage 0.41 mm links, 0.42 mm hoch  
 Streuwert 1.18, horizontal: 1.43, vertikal: 0.85

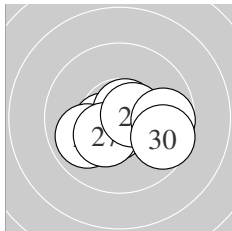

Serie 3:  
 10.5 \*                      10.5 \*                      10.8 \*                      10.6 \*                      9.9 ↖  
 10.7 \*                      10.3 \*                      10.6 \*                      9.7 →                      9.6 ↘  
 beste Teiler 36.0 (23.) 62.8 (26.) 79.6 (24.)  
 Trefferlage 0.37 mm rechts, 0.49 mm tief  
 Streuwert 1.29, horizontal: 1.71, vertikal: 0.62

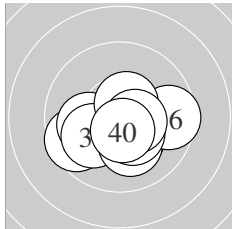

Serie 4:  
 10.3 \*                      9.6 ↖                      10.1 ←                      10.0 ↖                      10.1 ↘  
 9.6 →                      10.4 \*                      10.5 \*                      10.5 \*                      10.6 \*  
 beste Teiler 96.3 (40.) 104.2 (38.) 111.4 (39.)  
 Trefferlage 0.08 mm rechts, 0.80 mm tief  
 Streuwert 1.47, horizontal: 1.90, vertikal: 0.84

Unterschrift des Schuetzen

Meyton Elektronik

Ergebnis: **412.8** (396)  
 Serien: 102.6 104.6 103.8 101.8  
 Zaehler: 36 4 0 0 0 0 0 0 0 0  
 Innenzehner: 29  
 weiteste: 378 (36), 287 (8), 267 (38)  
 beste Teiler 1.4 (30.) 28.1 (7.) 59.6 (15.)  
 Trefferlage 0.08 mm links, 0.33 mm hoch  
 Streuwert 1.22, horizontal: 1.35, vertikal: 1.08

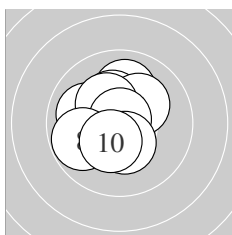
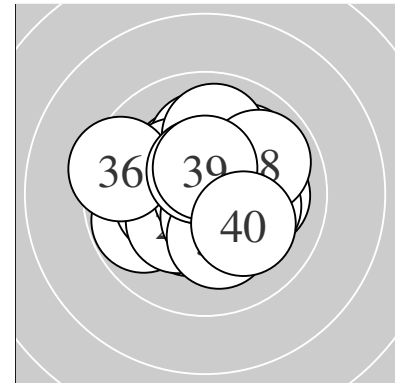

Serie 1:  
 10.4 \* 10.0 ← 10.0 ↑ 10.3 \* 10.2 \*  
 10.3 \* 10.8 \* 9.8 ← 10.4 \* 10.4 \*  
 beste Teiler 28.1 (7.) 128.0 (1.) 144.0 (10.)  
 Trefferlage 0.52 mm links, 0.49 mm hoch  
 Streuwert 1.28, horizontal: 1.22, vertikal: 1.33

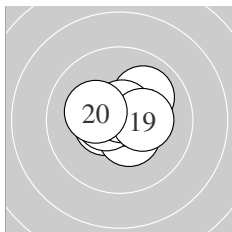

Serie 2:  
 10.6 \* 10.5 \* 10.4 \* 10.0 ↗ 10.7 \*  
 10.6 \* 10.6 \* 10.7 \* 10.3 \* 10.2 \*  
 beste Teiler 59.6 (15.) 65.5 (18.) 84.7 (16.)  
 Trefferlage 0.10 mm rechts, 0.20 mm hoch  
 Streuwert 0.97, horizontal: 1.18, vertikal: 0.71

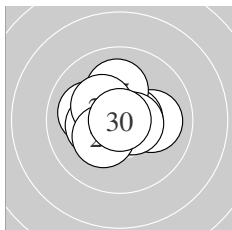

Serie 3:  
 10.0 → 10.6 \* 10.6 \* 10.1 ← 10.1 ↑  
 10.6 \* 10.3 \* 10.3 \* 10.3 \* 10.9 \*  
 beste Teiler 1.4 (30.) 85.5 (23.) 94.1 (26.)  
 Trefferlage 0.24 mm links, 0.29 mm hoch  
 Streuwert 1.16, horizontal: 1.36, vertikal: 0.91

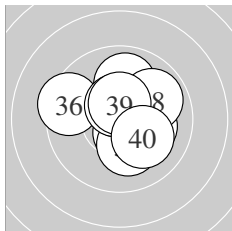

Serie 4:  
 10.5 \* 10.2 \* 9.9 ↑ 10.2 \* 10.6 \*  
 9.4 ← 10.5 \* 9.9 ↗ 10.5 \* 10.1 ↘  
 beste Teiler 97.3 (35.) 101.6 (37.) 102.4 (31.)  
 Trefferlage 0.31 mm rechts, 0.34 mm hoch  
 Streuwert 1.53, horizontal: 1.65, vertikal: 1.39

Unterschrift des Schuetzen

Meyton Elektronik



Ergebnis: **419.0** (398)  
 Serien: 105.7 106.0 103.6 103.7  
 Zaehler: 38 2 0 0 0 0 0 0 0 0  
 Innenzehner: 36  
 weiteste: 262 (32), 258 (28), 211 (38)  
 beste Teiler 24.1 (15.) 28.4 (5.) 38.6 (40.)  
 Trefferlage 0.11 mm rechts, 0.03 mm tief  
 Streuwert 0.95, horizontal: 1.03, vertikal: 0.86

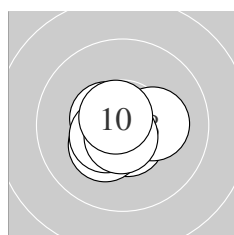
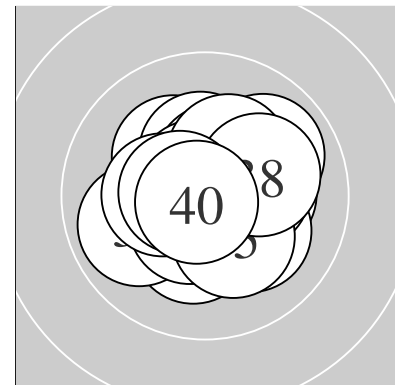

Serie 1:  
 10.6 \* 10.6 \* 10.3 \* 10.5 \* 10.8 \*  
 10.5 \* 10.8 \* 10.2 \* 10.7 \* 10.7 \*  
 beste Teiler 28.4 (5.) 42.1 (7.) 64.5 (10.)  
 Trefferlage 0.19 mm links, 0.30 mm tief  
 Streuwert 0.74, horizontal: 0.88, vertikal: 0.56

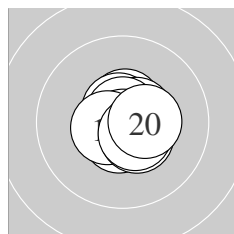

Serie 2:  
 10.6 \* 10.6 \* 10.6 \* 10.7 \* 10.9 \*  
 10.6 \* 10.6 \* 10.5 \* 10.5 \* 10.4 \*  
 beste Teiler 24.1 (15.) 51.0 (14.) 78.7 (12.)  
 Trefferlage 0.26 mm rechts, 0.02 mm tief  
 Streuwert 0.68, horizontal: 0.68, vertikal: 0.68

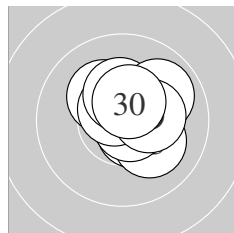

Serie 3:  
 10.6 \* 10.4 \* 10.1 ↘ 10.7 \* 10.2 \*  
 10.6 \* 10.3 \* 9.9 ↗ 10.3 \* 10.5 \*  
 beste Teiler 53.0 (24.) 83.6 (26.) 94.7 (21.)  
 Trefferlage 0.63 mm rechts, 0.44 mm hoch  
 Streuwert 1.01, horizontal: 1.05, vertikal: 0.98

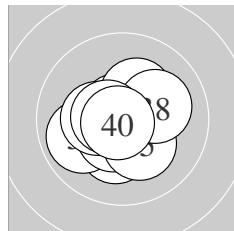

Serie 4:  
 10.3 \* 9.9 ↙ 10.7 \* 10.5 \* 10.2 \*  
 10.3 \* 10.3 \* 10.1 → 10.6 \* 10.8 \*  
 beste Teiler 38.6 (40.) 62.2 (33.) 92.9 (39.)  
 Trefferlage 0.26 mm links, 0.24 mm tief  
 Streuwert 1.16, horizontal: 1.28, vertikal: 1.03

Unterschrift des Schuetzen

Meyton Elektronik

Ergebnis: **422.6** (400)  
 Serien: 106.1 106.0 105.4 105.1  
 Zaehler: 40 0 0 0 0 0 0 0 0 0  
 Innenzehner: 39  
 weiteste: 233 (40), 199 (24), 177 (29)  
 beste Teiler 6.0 (5.) 25.5 (17.) 36.6 (6.)  
 Trefferlage 0.01 mm rechts, 0.05 mm hoch  
 Streuwert 0.78, horizontal: 0.93, vertikal: 0.60

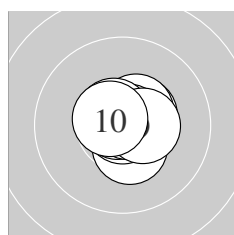
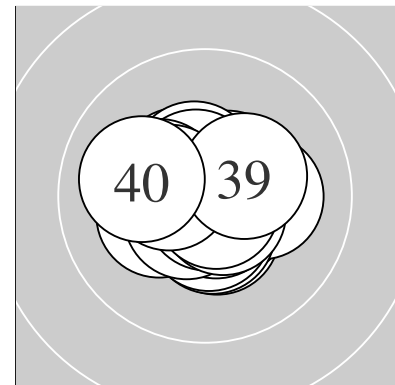

Serie 1:  
 10.5 \* 10.4 \* 10.5 \* 10.5 \* 10.9 \*  
 10.8 \* 10.8 \* 10.6 \* 10.5 \* 10.6 \*  
 beste Teiler 6.0 (5.) 36.6 (6.) 39.4 (7.)  
 Trefferlage 0.32 mm rechts, 0.14 mm hoch  
 Streuwert 0.64, horizontal: 0.70, vertikal: 0.58

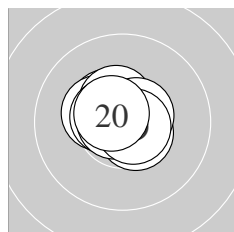

Serie 2:  
 10.4 \* 10.3 \* 10.5 \* 10.6 \* 10.6 \*  
 10.8 \* 10.9 \* 10.6 \* 10.7 \* 10.6 \*  
 beste Teiler 25.5 (17.) 48.2 (16.) 68.1 (19.)  
 Trefferlage 0.24 mm links, 0.32 mm hoch  
 Streuwert 0.67, horizontal: 0.79, vertikal: 0.52

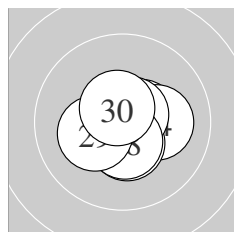

Serie 3:  
 10.5 \* 10.8 \* 10.7 \* 10.2 \* 10.8 \*  
 10.4 \* 10.7 \* 10.5 \* 10.2 \* 10.6 \*  
 beste Teiler 43.8 (25.) 50.0 (22.) 67.2 (27.)  
 Trefferlage 0.28 mm rechts, 0.14 mm tief  
 Streuwert 0.84, horizontal: 0.97, vertikal: 0.68

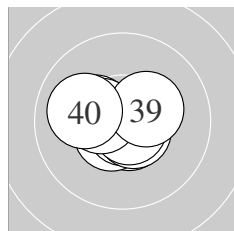

Serie 4:  
 10.8 \* 10.6 \* 10.3 \* 10.6 \* 10.8 \*  
 10.6 \* 10.7 \* 10.4 \* 10.3 \* 10.0 \*  
 beste Teiler 39.8 (31.) 42.7 (35.) 53.8 (37.)  
 Trefferlage 0.32 mm links, 0.09 mm tief  
 Streuwert 0.90, horizontal: 1.14, vertikal: 0.56

Unterschrift des Schuetzen

Meyton Elektronik

Ergebnis: **420.7** (398)  
 Serien: 104.9 105.0 105.7 105.1  
 Zaehler: 38 2 0 0 0 0 0 0 0 0  
 Innenzehner: 37  
 weiteste: 269 (1), 258 (19), 221 (31)  
 beste Teiler 21.3 (34.) 29.8 (16.) 34.5 (21.)  
 Trefferlage 0.06 mm links, 0.07 mm tief  
 Streuwert 0.89, horizontal: 0.80, vertikal: 0.98

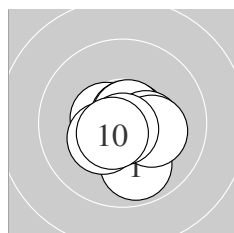
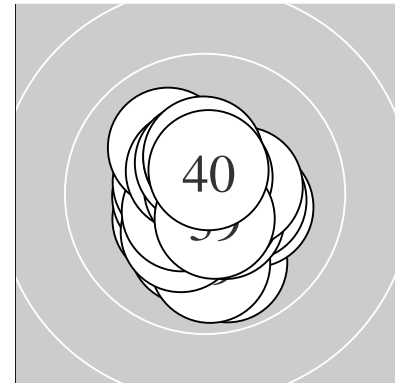

Serie 1:  
 9.9 ↓                      10.5 \*                      10.8 \*                      10.7 \*                      10.7 \*  
 10.4 \*                      10.2 \*                      10.3 \*                      10.8 \*                      10.6 \*  
 beste Teiler 37.0 (9.) 48.3 (3.) 57.2 (5.)  
 Trefferlage 0.23 mm rechts, 0.37 mm tief  
 Streuwert 0.96, horizontal: 1.00, vertikal: 0.91

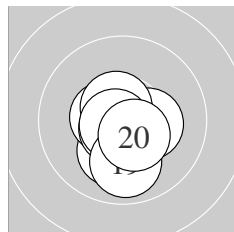

Serie 2:  
 10.2 \*                      10.5 \*                      10.8 \*                      10.3 \*                      10.7 \*  
 10.8 \*                      10.6 \*                      10.7 \*                      9.9 ↓                      10.5 \*  
 beste Teiler 29.8 (16.) 42.2 (13.) 54.9 (18.)  
 Trefferlage 0.07 mm links, 0.59 mm tief  
 Streuwert 0.88, horizontal: 0.75, vertikal: 0.99

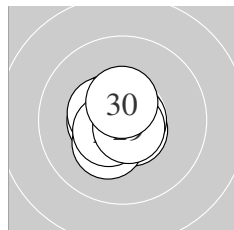

Serie 3:  
 10.8 \*                      10.5 \*                      10.6 \*                      10.6 \*                      10.3 \*  
 10.4 \*                      10.5 \*                      10.8 \*                      10.7 \*                      10.5 \*  
 beste Teiler 34.5 (21.) 49.0 (28.) 59.6 (29.)  
 Trefferlage 0.37 mm links, 0.07 mm tief  
 Streuwert 0.72, horizontal: 0.70, vertikal: 0.74

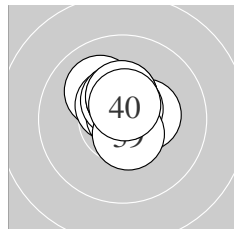

Serie 4:  
 10.1 ↘                      10.5 \*                      10.4 \*                      10.9 \*                      10.5 \*  
 10.4 \*                      10.7 \*                      10.4 \*                      10.6 \*                      10.6 \*  
 beste Teiler 21.3 (34.) 68.9 (37.) 89.9 (40.)  
 Trefferlage 0.04 mm links, 0.75 mm hoch  
 Streuwert 0.75, horizontal: 0.73, vertikal: 0.77

Unterschrift des Schuetzen

Meyton Elektronik

Ergebnis: **416.2** (393)  
 Serien: 103.5 104.2 103.9 104.6  
 Zaehler: 33 7 0 0 0 0 0 0 0 0  
 Innenzehner: 31  
 weiteste: 325 (24), 317 (22), 282 (16)  
 beste Teiler 44.5 (26.) 45.1 (20.) 52.2 (11.)  
 Trefferlage 0.09 mm rechts, 0.07 mm tief  
 Streuwert 1.14, horizontal: 1.34, vertikal: 0.91

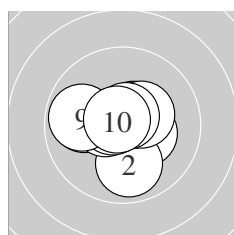
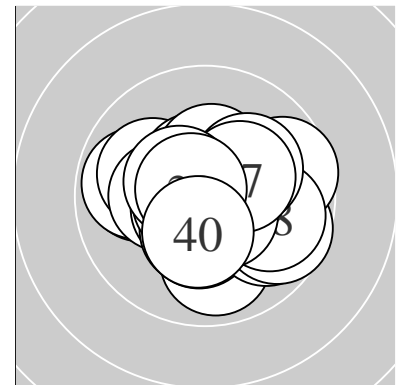

Serie 1:  
 10.3 \* 9.9 ↓ 9.9 ← 10.5 \* 10.6 \*  
 10.4 \* 10.7 \* 10.7 \* 9.8 ← 10.7 \*  
 beste Teiler 53.7 (10.) 64.8 (8.) 72.4 (7.)  
 Trefferlage 0.34 mm links, 0.05 mm hoch  
 Streuwert 1.25, horizontal: 1.46, vertikal: 0.99

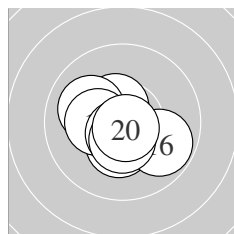

Serie 2:  
 10.7 \* 10.4 \* 10.6 \* 10.5 \* 10.0 ↖  
 9.8 ↘ 10.3 \* 10.6 \* 10.5 \* 10.8 \*  
 beste Teiler 45.1 (20.) 52.2 (11.) 80.3 (18.)  
 Trefferlage 0.28 mm links, 0.40 mm tief  
 Streuwert 1.06, horizontal: 1.23, vertikal: 0.86

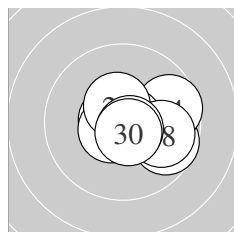

Serie 3:  
 10.7 \* 9.7 ↘ 10.7 \* 9.7 → 10.6 \*  
 10.8 \* 10.5 \* 9.9 ↘ 10.7 \* 10.6 \*  
 beste Teiler 44.5 (26.) 62.3 (23.) 67.8 (29.)  
 Trefferlage 0.80 mm rechts, 0.08 mm tief  
 Streuwert 1.20, horizontal: 1.50, vertikal: 0.79

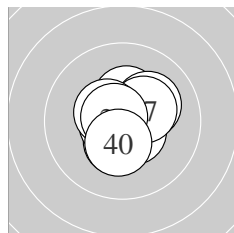

Serie 4:  
 10.5 \* 10.4 \* 10.4 \* 10.7 \* 10.6 \*  
 10.1 ↗ 10.3 \* 10.5 \* 10.7 \* 10.4 \*  
 beste Teiler 63.5 (39.) 71.7 (34.) 98.2 (35.)  
 Trefferlage 0.20 mm rechts, 0.11 mm hoch  
 Streuwert 0.98, horizontal: 0.94, vertikal: 1.01

Unterschrift des Schuetzen

Ergebnis: **412.6** (396)  
 Serien: 102.2 101.9 103.8 104.7  
 Zaehler: 37 2 1 0 0 0 0 0 0  
 Innenzehner: 30  
 weiteste: 541 (6), 283 (13), 269 (38)  
 beste Teiler 11.7 (34.) 40.1 (36.) 43.6 (26.)  
 Trefferlage 0.41 mm links, 0.14 mm tief  
 Streuwert 1.28, horizontal: 1.65, vertikal: 0.76

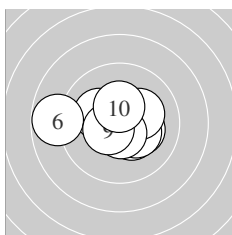
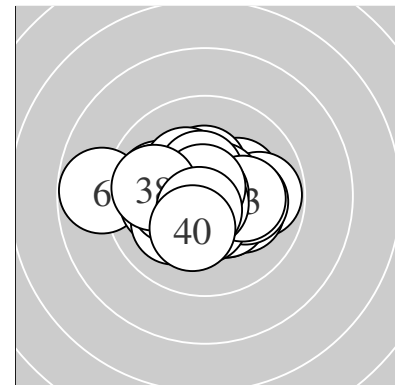

Serie 1:  
 10.2 \*                      10.6 \*                      10.4 \*                      10.2 \*                      10.3 \*  
 8.8 ←                      10.2 \*                      10.6 \*                      10.5 \*                      10.4 \*  
 beste Teiler 81.2 (2.) 86.9 (8.) 109.5 (9.)  
 Trefferlage 0.17 mm links, 0.10 mm tief  
 Streuwert 1.65, horizontal: 2.17, vertikal: 0.86

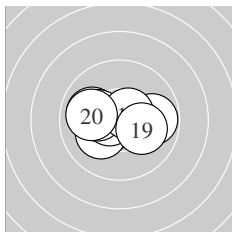

Serie 2:  
 10.4 \*                      10.0 ←                      9.8 →                      10.0 ←                      10.2 \*  
 10.6 \*                      10.2 \*                      10.6 \*                      10.1 →                      10.0 ←  
 beste Teiler 87.0 (16.) 92.8 (18.) 138.0 (11.)  
 Trefferlage 0.72 mm links, 0.00 mm  
 Streuwert 1.41, horizontal: 1.90, vertikal: 0.64

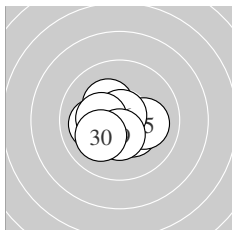

Serie 3:  
 10.3 \*                      10.6 \*                      10.7 \*                      10.4 \*                      10.1 →  
 10.8 \*                      10.1 ←                      10.3 \*                      10.4 \*                      10.1 ←  
 beste Teiler 43.6 (26.) 62.1 (23.) 85.3 (22.)  
 Trefferlage 0.34 mm links, 0.29 mm tief  
 Streuwert 1.12, horizontal: 1.36, vertikal: 0.81

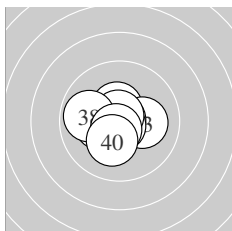

Serie 4:  
 10.3 \*                      10.5 \*                      10.2 \*                      10.9 \*                      10.5 \*  
 10.8 \*                      10.8 \*                      9.9 ←                      10.6 \*                      10.2 \*  
 beste Teiler 11.7 (34.) 40.1 (36.) 47.8 (37.)  
 Trefferlage 0.43 mm links, 0.18 mm tief  
 Streuwert 1.02, horizontal: 1.21, vertikal: 0.80

Unterschrift des Schuetzen

Ergebnis: **409.2** (389)  
 Serien: 103.0 102.4 100.5 103.3  
 Zaehler: 29 11 0 0 0 0 0 0 0 0  
 Innenzehner: 25  
 weiteste: 387 (20), 325 (25), 317 (40)  
 beste Teiler 26.6 (15.) 44.7 (36.) 56.0 (29.)  
 Trefferlage 0.87 mm links, 0.08 mm hoch  
 Streuwert 1.31, horizontal: 1.45, vertikal: 1.15

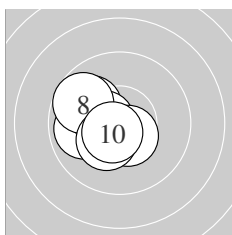
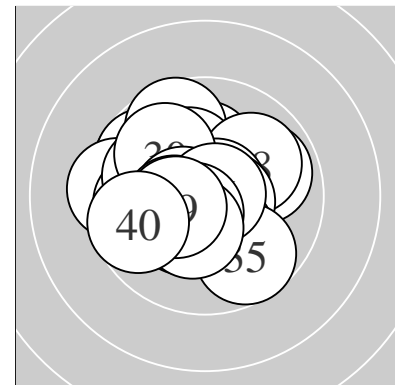

Serie 1:  
 10.0 ↘ 10.3 \* 9.9 ← 10.6 \* 10.6 \*  
 10.5 \* 10.5 \* 9.7 ↘ 10.3 \* 10.6 \*  
 beste Teiler 80.0 (4.) 86.8 (10.) 97.0 (5.)  
 Trefferlage 1.22 mm links, 0.16 mm tief  
 Streuwert 0.97, horizontal: 1.03, vertikal: 0.90

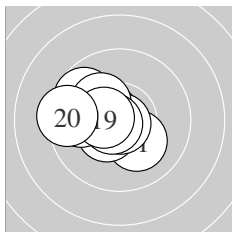

Serie 2:  
 10.2 \* 10.5 \* 9.7 ↘ 10.6 \* 10.8 \*  
 9.8 ← 10.2 \* 10.7 \* 10.5 \* 9.4 ←  
 beste Teiler 26.6 (15.) 60.8 (18.) 89.8 (14.)  
 Trefferlage 1.28 mm links, 0.11 mm hoch  
 Streuwert 1.24, horizontal: 1.49, vertikal: 0.92

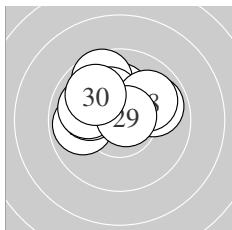

Serie 3:  
 9.9 ← 10.0 ↘ 10.0 ↘ 10.2 \* 9.7 ↗  
 10.2 \* 9.9 → 10.0 ↗ 10.7 \* 9.9 ↘  
 beste Teiler 56.0 (29.) 181.4 (26.) 195.0 (24.)  
 Trefferlage 0.59 mm links, 1.25 mm hoch  
 Streuwert 1.44, horizontal: 1.82, vertikal: 0.93

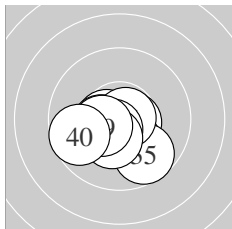

Serie 4:  
 10.6 \* 10.2 \* 10.6 \* 10.4 \* 9.7 ↘  
 10.8 \* 10.6 \* 10.3 \* 10.4 \* 9.7 ←  
 beste Teiler 44.7 (36.) 88.6 (31.) 94.0 (37.)  
 Trefferlage 0.38 mm links, 0.86 mm tief  
 Streuwert 1.13, horizontal: 1.38, vertikal: 0.81

Unterschrift des Schuetzen

Meyton Elektronik

Ergebnis: **412.5** (394)  
 Serien: 103.7 103.2 103.5 102.1  
 Zaehler: 34 6 0 0 0 0 0 0 0 0  
 Innenzehner: 32  
 weiteste: 459 (29), 405 (38), 366 (31)  
 beste Teiler 38.4 (22.) 42.0 (6.) 52.3 (14.)  
 Trefferlage 0.53 mm links, 0.15 mm hoch  
 Streuwert 1.29, horizontal: 1.60, vertikal: 0.86

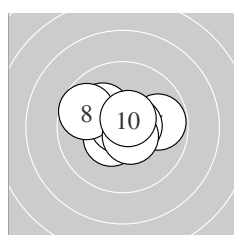
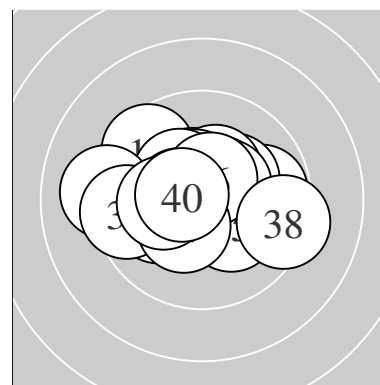

Serie 1:  
 10.4 \*                      10.6 \*                      10.5 \*                      10.1 ↘                      9.8 →  
 10.8 \*                      10.6 \*                      9.7 ↙                      10.6 \*                      10.6 \*  
 beste Teiler 42.0 (6.) 79.3 (2.) 81.8 (10.)  
 Trefferlage 0.27 mm links, 0.34 mm hoch  
 Streuwert 1.23, horizontal: 1.58, vertikal: 0.72

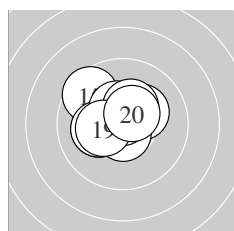

Serie 2:  
 10.2 \*                      10.2 \*                      10.7 \*                      10.7 \*                      9.6 ↘  
 10.2 \*                      10.4 \*                      10.4 \*                      10.3 \*                      10.5 \*  
 beste Teiler 52.3 (14.) 73.1 (13.) 112.6 (20.)  
 Trefferlage 0.55 mm links, 0.54 mm hoch  
 Streuwert 1.19, horizontal: 1.35, vertikal: 0.99

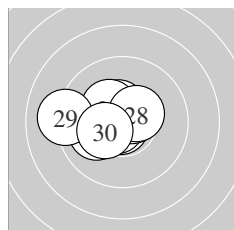

Serie 3:  
 10.7 \*                      10.8 \*                      10.7 \*                      10.6 \*                      10.1 ←  
 10.5 \*                      10.3 \*                      10.4 \*                      9.1 ←                      10.3 \*  
 beste Teiler 38.4 (22.) 54.2 (21.) 56.4 (23.)  
 Trefferlage 0.88 mm links, 0.18 mm hoch  
 Streuwert 1.24, horizontal: 1.60, vertikal: 0.71

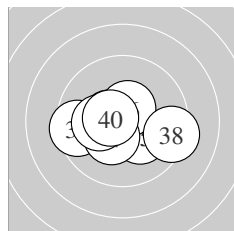

Serie 4:  
 9.5 ←                      10.5 \*                      10.6 \*                      10.4 \*                      10.2 \*  
 10.5 \*                      10.3 \*                      9.3 →                      10.2 \*                      10.6 \*  
 beste Teiler 99.2 (33.) 99.9 (40.) 107.1 (36.)  
 Trefferlage 0.41 mm links, 0.45 mm tief  
 Streuwert 1.52, horizontal: 2.01, vertikal: 0.76

Unterschrift des Schuetzen

Meyton Elektronik

Ergebnis: **410.9** (390)  
 Serien: 101.8 103.1 103.9 102.1  
 Zaehler: 30 10 0 0 0 0 0 0 0 0  
 Innenzehner: 26  
 weiteste: 344 (1), 341 (40), 340 (36)  
 beste Teiler 23.0 (12.) 35.3 (27.) 43.9 (7.)  
 Trefferlage 0.21 mm rechts, 0.53 mm hoch  
 Streuwert 1.34, horizontal: 1.71, vertikal: 0.83

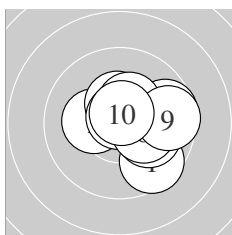
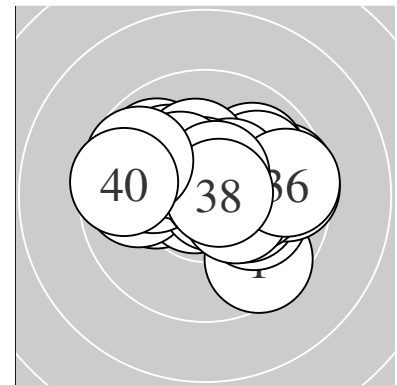

Serie 1:  
 9.6 ↘ 10.2 \* 10.4 \* 10.1 ↘ 9.7 →  
 10.4 \* 10.8 \* 10.3 \* 9.6 → 10.7 \*  
 beste Teiler 43.9 (7.) 71.3 (10.) 137.1 (3.)  
 Trefferlage 1.12 mm rechts, 0.10 mm hoch  
 Streuwert 1.43, horizontal: 1.64, vertikal: 1.19

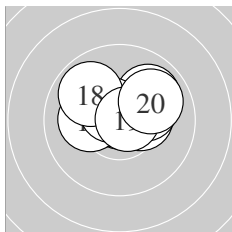

Serie 2:  
 9.9 ↗ 10.9 \* 10.5 \* 10.1 ← 10.4 \*  
 10.2 \* 10.6 \* 9.9 ↘ 10.7 \* 9.9 ↗  
 beste Teiler 23.0 (12.) 55.5 (19.) 88.8 (17.)  
 Trefferlage 0.22 mm rechts, 0.70 mm hoch  
 Streuwert 1.23, horizontal: 1.61, vertikal: 0.66

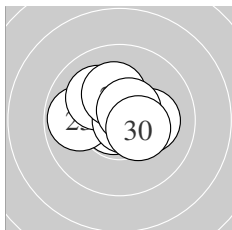

Serie 3:  
 10.8 \* 10.2 \* 9.8 ← 10.7 \* 10.3 \*  
 10.1 ↘ 10.8 \* 10.2 \* 10.6 \* 10.4 \*  
 beste Teiler 35.3 (27.) 44.2 (21.) 59.0 (24.)  
 Trefferlage 0.10 mm links, 0.52 mm hoch  
 Streuwert 1.14, horizontal: 1.37, vertikal: 0.83

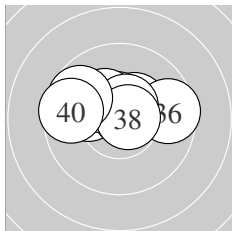

Serie 4:  
 10.4 \* 10.0 ← 10.5 \* 10.7 \* 10.3 \*  
 9.6 → 10.6 \* 10.7 \* 9.7 ↘ 9.6 ←  
 beste Teiler 52.0 (34.) 59.4 (38.) 97.4 (37.)  
 Trefferlage 0.36 mm links, 0.79 mm hoch  
 Streuwert 1.45, horizontal: 2.01, vertikal: 0.42

Unterschrift des Schuetzen

Meyton Elektronik



Ergebnis: **418.1** (396)  
 Serien: 106.3 105.3 104.4 102.1  
 Zaehler: 36 4 0 0 0 0 0 0 0 0  
 Innenzehner: 34  
 weiteste: 369 (38), 288 (32), 282 (33)  
 beste Teiler 5.6 (34.) 9.2 (1.) 41.0 (15.)  
 Trefferlage 0.15 mm links, 0.11 mm tief  
 Streuwert 1.07, horizontal: 1.13, vertikal: 0.99

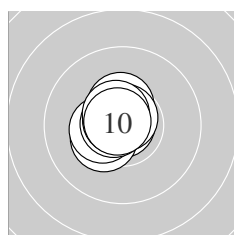
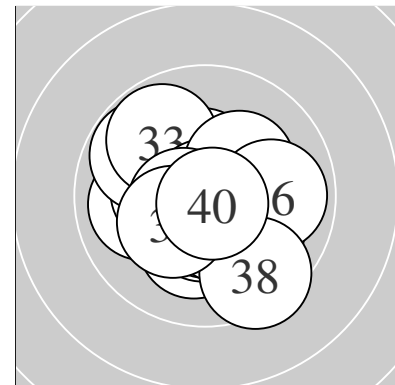

Serie 1:  
 10.9 \* 10.3 \* 10.4 \* 10.8 \* 10.4 \*  
 10.7 \* 10.7 \* 10.7 \* 10.6 \* 10.8 \*  
 beste Teiler 9.2 (1.) 43.0 (10.) 49.6 (4.)  
 Trefferlage 0.49 mm links, 0.23 mm hoch  
 Streuwert 0.53, horizontal: 0.47, vertikal: 0.58

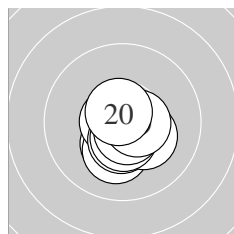

Serie 2:  
 10.3 \* 10.2 \* 10.7 \* 10.5 \* 10.8 \*  
 10.3 \* 10.5 \* 10.7 \* 10.6 \* 10.7 \*  
 beste Teiler 41.0 (15.) 65.1 (13.) 67.5 (18.)  
 Trefferlage 0.11 mm rechts, 0.65 mm tief  
 Streuwert 0.73, horizontal: 0.68, vertikal: 0.78

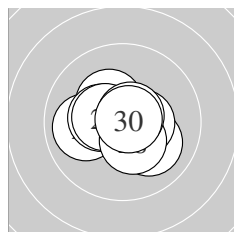

Serie 3:  
 10.3 \* 10.1 ↘ 10.0 ← 10.7 \* 10.4 \*  
 10.5 \* 10.5 \* 10.4 \* 10.7 \* 10.8 \*  
 beste Teiler 44.2 (30.) 54.2 (24.) 68.2 (29.)  
 Trefferlage 0.09 mm links, 0.09 mm tief  
 Streuwert 1.09, horizontal: 1.32, vertikal: 0.80

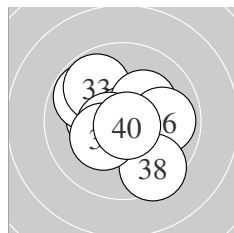

Serie 4:  
 10.3 \* 9.8 ↖ 9.8 ↖ 10.9 \* 10.2 \*  
 9.9 → 10.6 \* 9.5 ↘ 10.3 \* 10.8 \*  
 beste Teiler 5.6 (34.) 42.4 (40.) 91.7 (37.)  
 Trefferlage 0.14 mm links, 0.05 mm hoch  
 Streuwert 1.60, horizontal: 1.71, vertikal: 1.49

Unterschrift des Schuetzen

Meyton Elektronik

Ergebnis: **418.6** (397)  
 Serien: 104.6 104.8 106.2 103.0  
 Zaehler: 37 3 0 0 0 0 0 0 0 0  
 Innenzehner: 36  
 weiteste: 411 (33), 339 (2), 264 (13)  
 beste Teiler 18.3 (28.) 25.6 (10.) 43.9 (30.)  
 Trefferlage 0.13 mm links, 0.09 mm hoch  
 Streuwert 1.04, horizontal: 1.13, vertikal: 0.93

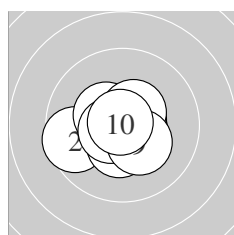
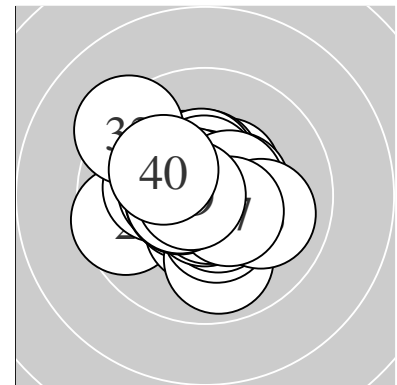

Serie 1:  
 10.7 \* 9.6 ← 10.6 \* 10.4 \* 10.6 \*  
 10.5 \* 10.4 \* 10.6 \* 10.3 \* 10.9 \*  
 beste Teiler 25.6 (10.) 74.8 (1.) 83.1 (5.)  
 Trefferlage 0.14 mm links, 0.22 mm tief  
 Streuwert 1.09, horizontal: 1.33, vertikal: 0.77

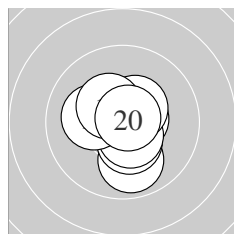

Serie 2:  
 10.8 \* 10.8 \* 9.9 ↓ 10.6 \* 10.4 \*  
 10.5 \* 10.4 \* 10.2 \* 10.4 \* 10.8 \*  
 beste Teiler 45.1 (12.) 45.6 (20.) 48.3 (11.)  
 Trefferlage 0.07 mm rechts, 0.18 mm tief  
 Streuwert 1.02, horizontal: 0.91, vertikal: 1.12

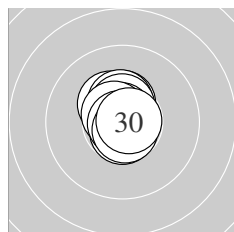

Serie 3:  
 10.4 \* 10.4 \* 10.4 \* 10.7 \* 10.5 \*  
 10.8 \* 10.6 \* 10.9 \* 10.7 \* 10.8 \*  
 beste Teiler 18.3 (28.) 43.9 (30.) 48.3 (26.)  
 Trefferlage 0.13 mm links, 0.47 mm hoch  
 Streuwert 0.59, horizontal: 0.36, vertikal: 0.75

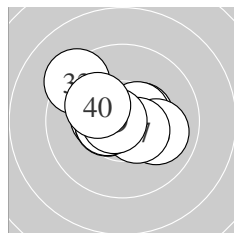

Serie 4:  
 10.4 \* 10.5 \* 9.3 ↘ 10.4 \* 10.5 \*  
 10.0 → 10.5 \* 10.5 \* 10.7 \* 10.2 \*  
 beste Teiler 58.0 (39.) 103.5 (38.) 104.0 (35.)  
 Trefferlage 0.33 mm links, 0.32 mm hoch  
 Streuwert 1.36, horizontal: 1.65, vertikal: 0.98

Unterschrift des Schuetzen

Meyton Elektronik

Ergebnis: **418.2** (397)  
 Serien: 105.0 103.4 104.7 105.1  
 Zaehler: 37 3 0 0 0 0 0 0 0 0  
 Innenzehner: 35  
 weiteste: 483 (18), 422 (6), 284 (16)  
 beste Teiler 13.6 (35.) 14.0 (2.) 21.1 (3.)  
 Trefferlage 0.10 mm links, 0.46 mm tief  
 Streuwert 1.08, horizontal: 1.29, vertikal: 0.82

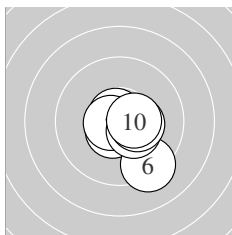
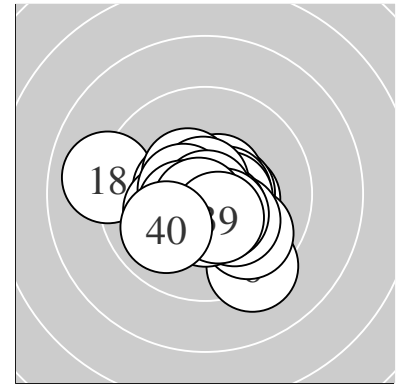

Serie 1:  
 10.6 \*                      10.9 \*                      10.9 \*                      10.6 \*                      10.7 \*  
 9.3 ↘                      10.7 \*                      10.4 \*                      10.4 \*                      10.5 \*  
 beste Teiler 14.0 (2.) 21.1 (3.) 54.4 (5.)  
 Trefferlage 0.49 mm rechts, 0.60 mm tief  
 Streuwert 1.05, horizontal: 1.00, vertikal: 1.10

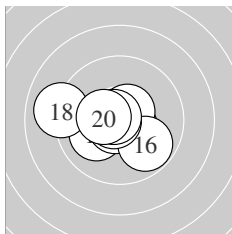

Serie 2:  
 10.8 \*                      10.5 \*                      10.1 ↙                      10.6 \*                      10.7 \*  
 9.8 ↘                      10.8 \*                      9.0 ←                      10.7 \*                      10.4 \*  
 beste Teiler 47.8 (17.) 48.4 (11.) 53.7 (19.)  
 Trefferlage 0.61 mm links, 0.23 mm tief  
 Streuwert 1.43, horizontal: 1.85, vertikal: 0.84

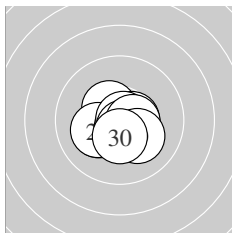

Serie 3:  
 10.2 \*                      10.4 \*                      10.2 \*                      10.7 \*                      10.6 \*  
 10.8 \*                      10.7 \*                      10.5 \*                      10.2 \*                      10.4 \*  
 beste Teiler 31.6 (26.) 58.8 (24.) 67.6 (27.)  
 Trefferlage 0.00 mm , 0.44 mm tief  
 Streuwert 0.94, horizontal: 1.12, vertikal: 0.71

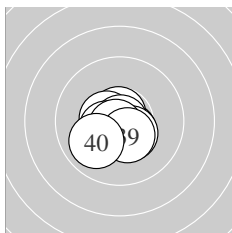

Serie 4:  
 10.5 \*                      10.7 \*                      10.5 \*                      10.5 \*                      10.9 \*  
 10.5 \*                      10.4 \*                      10.7 \*                      10.4 \*                      10.0 ↙  
 beste Teiler 13.6 (35.) 56.3 (38.) 56.8 (32.)  
 Trefferlage 0.28 mm links, 0.58 mm tief  
 Streuwert 0.80, horizontal: 0.92, vertikal: 0.66

Unterschrift des Schuetzen

Meyton Elektronik

Ergebnis: **413.7** (396)  
 Serien: 102.8 102.7 105.0 103.2  
 Zaehler: 36 4 0 0 0 0 0 0 0 0  
 Innenzehner: 28  
 weiteste: 317 (12), 296 (6), 272 (18)  
 beste Teiler 19.1 (27.) 40.2 (9.) 42.0 (5.)  
 Trefferlage 0.19 mm rechts, 0.24 mm tief  
 Streuwert 1.21, horizontal: 1.34, vertikal: 1.06

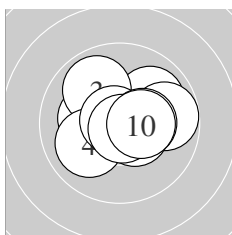
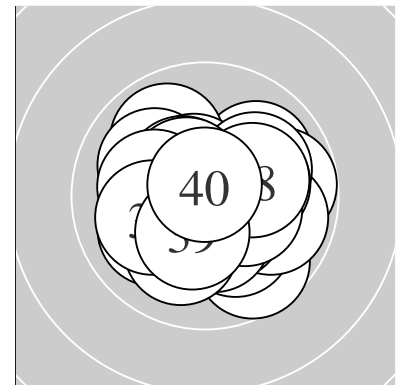

Serie 1:  
 10.0 ↗ 10.2 \* 9.9 ↘ 10.0 ↙ 10.8 \*  
 9.8 → 10.5 \* 10.4 \* 10.8 \* 10.4 \*  
 beste Teiler 40.2 (9.) 42.0 (5.) 115.6 (7.)  
 Trefferlage 0.33 mm rechts, 0.23 mm hoch  
 Streuwert 1.40, horizontal: 1.71, vertikal: 0.99

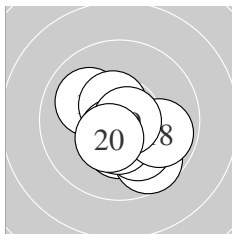

Serie 2:  
 10.3 \* 9.7 ↘ 10.0 ↖ 10.5 \* 10.1 ↘  
 10.4 \* 10.6 \* 9.9 → 10.8 \* 10.4 \*  
 beste Teiler 49.3 (19.) 93.4 (17.) 107.4 (14.)  
 Trefferlage 0.25 mm rechts, 0.79 mm tief  
 Streuwert 1.26, horizontal: 1.33, vertikal: 1.19

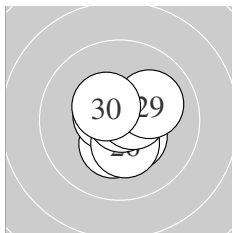

Serie 3:  
 10.4 \* 10.3 \* 10.6 \* 10.7 \* 10.6 \*  
 10.3 \* 10.9 \* 10.6 \* 10.1 → 10.5 \*  
 beste Teiler 19.1 (27.) 54.2 (24.) 85.3 (25.)  
 Trefferlage 0.19 mm rechts, 0.21 mm tief  
 Streuwert 0.93, horizontal: 0.88, vertikal: 0.97

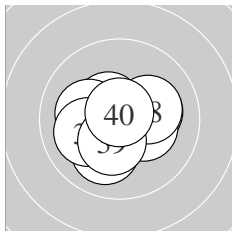

Serie 4:  
 10.5 \* 10.6 \* 10.2 \* 10.1 ← 10.3 \*  
 10.1 ↓ 10.1 ← 10.2 \* 10.3 \* 10.8 \*  
 beste Teiler 44.0 (40.) 79.4 (32.) 111.9 (31.)  
 Trefferlage 0.01 mm links, 0.20 mm tief  
 Streuwert 1.26, horizontal: 1.49, vertikal: 0.97

Unterschrift des Schuetzen

Meyton Elektronik

Ergebnis: **408.5** (390)  
 Serien: 99.7 102.2 101.9 104.7  
 Zaehler: 31 8 1 0 0 0 0 0 0  
 Innenzehner: 25  
 weiteste: 514 (8), 440 (1), 395 (30)  
 beste Teiler 5.0 (35.) 28.0 (24.) 47.1 (37.)  
 Trefferlage 0.63 mm links, 0.19 mm hoch  
 Streuwert 1.45, horizontal: 1.86, vertikal: 0.88

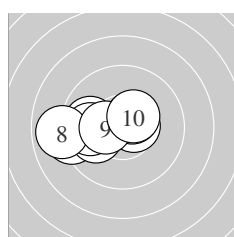
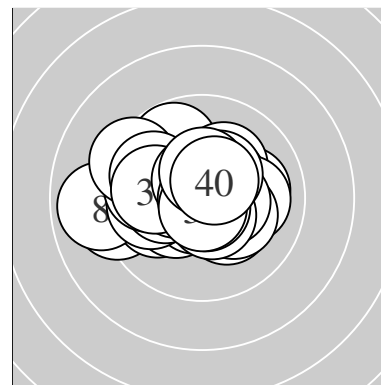

Serie 1:  
 9.2 ←                      10.6 \*                      10.5 \*                      10.0 ←                      10.0 ←  
 9.8 ←                      9.9 ←                      8.9 ←                      10.4 \*                      10.4 \*  
 beste Teiler 95.6 (2.) 115.2 (3.) 129.4 (10.)  
 Trefferlage 1.84 mm links, 0.00 mm  
 Streuwert 1.58, horizontal: 2.15, vertikal: 0.61

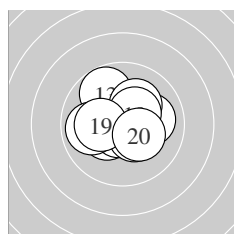

Serie 2:  
 10.0 →                      10.3 \*                      9.8 ↖                      10.7 \*                      10.4 \*  
 10.2 \*                      9.9 ←                      10.4 \*                      10.2 \*                      10.3 \*  
 beste Teiler 68.9 (14.) 137.2 (15.) 137.4 (18.)  
 Trefferlage 0.08 mm links, 0.18 mm hoch  
 Streuwert 1.44, horizontal: 1.64, vertikal: 1.19

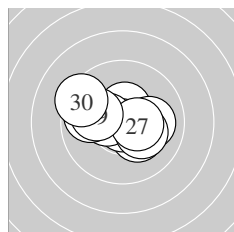

Serie 3:  
 10.3 \*                      10.5 \*                      10.0 →                      10.8 \*                      10.4 \*  
 10.2 \*                      10.5 \*                      9.8 ←                      10.0 ←                      9.4 ↖  
 beste Teiler 28.0 (24.) 116.4 (22.) 125.4 (27.)  
 Trefferlage 0.32 mm links, 0.18 mm hoch  
 Streuwert 1.56, horizontal: 2.01, vertikal: 0.90

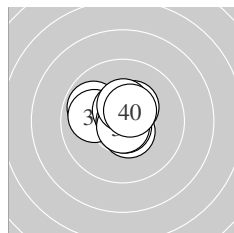

Serie 4:  
 10.5 \*                      9.9 ↖                      10.0 ←                      10.6 \*                      10.9 \*  
 10.7 \*                      10.8 \*                      10.4 \*                      10.4 \*                      10.5 \*  
 beste Teiler 5.0 (35.) 47.1 (37.) 51.4 (36.)  
 Trefferlage 0.29 mm links, 0.40 mm hoch  
 Streuwert 1.01, horizontal: 1.18, vertikal: 0.81

Unterschrift des Schuetzen

Meyton Elektronik

Ergebnis: **419.0** (400)  
 Serien: 104.1 104.9 105.1 104.9  
 Zaehler: 40 0 0 0 0 0 0 0 0 0  
 Innenzehner: 38  
 weiteste: 247 (29), 204 (39), 194 (2)  
 beste Teiler 2.0 (30.) 34.8 (16.) 39.4 (34.)  
 Trefferlage 0.31 mm links, 0.19 mm hoch  
 Streuwert 0.90, horizontal: 1.09, vertikal: 0.65

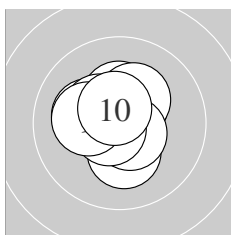
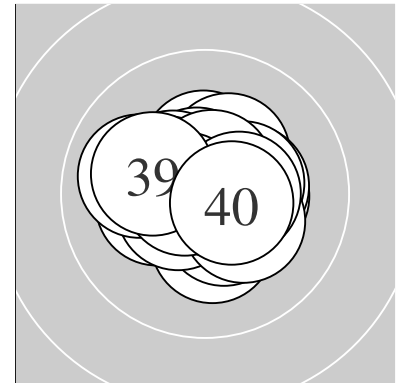

Serie 1:  
 10.3 \*                      10.2 \*                      10.4 \*                      10.3 \*                      10.5 \*  
 10.3 \*                      10.6 \*                      10.7 \*                      10.2 \*                      10.6 \*  
 beste Teiler 71.5 (8.) 88.3 (7.) 94.8 (10.)  
 Trefferlage 0.35 mm links, 0.35 mm hoch  
 Streuwert 1.01, horizontal: 1.02, vertikal: 1.01

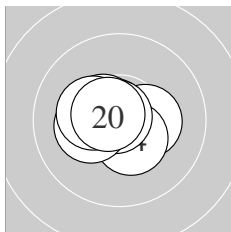

Serie 2:  
 10.6 \*                      10.3 \*                      10.4 \*                      10.4 \*                      10.8 \*  
 10.8 \*                      10.5 \*                      10.2 \*                      10.3 \*                      10.6 \*  
 beste Teiler 34.8 (16.) 49.4 (15.) 79.1 (20.)  
 Trefferlage 0.41 mm links, 0.01 mm hoch  
 Streuwert 0.87, horizontal: 1.11, vertikal: 0.52

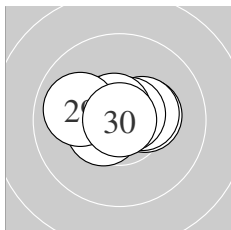

Serie 3:  
 10.6 \*                      10.3 \*                      10.5 \*                      10.4 \*                      10.7 \*  
 10.5 \*                      10.7 \*                      10.5 \*                      10.0 ←                      10.9 \*  
 beste Teiler 2.0 (30.) 64.8 (25.) 68.4 (27.)  
 Trefferlage 0.33 mm links, 0.22 mm hoch  
 Streuwert 0.90, horizontal: 1.22, vertikal: 0.37

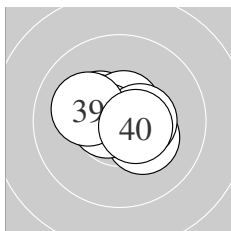

Serie 4:  
 10.3 \*                      10.4 \*                      10.3 \*                      10.8 \*                      10.7 \*  
 10.6 \*                      10.7 \*                      10.5 \*                      10.1 ←                      10.5 \*  
 beste Teiler 39.4 (34.) 55.3 (35.) 74.0 (37.)  
 Trefferlage 0.13 mm links, 0.19 mm hoch  
 Streuwert 0.92, horizontal: 1.16, vertikal: 0.58

Unterschrift des Schuetzen

Meyton Elektronik

Ergebnis: **412.4** (394)  
 Serien: 103.1 103.5 103.2 102.6  
 Zaehler: 34 6 0 0 0 0 0 0 0 0  
 Innenzehner: 29  
 weiteste: 353 (32), 295 (39), 281 (22)  
 beste Teiler 35.0 (29.) 46.2 (25.) 64.9 (2.)  
 Trefferlage 0.35 mm links, 0.17 mm hoch  
 Streuwert 1.24, horizontal: 1.43, vertikal: 1.00

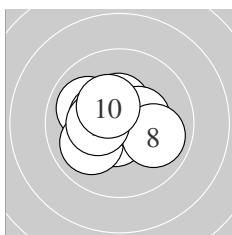
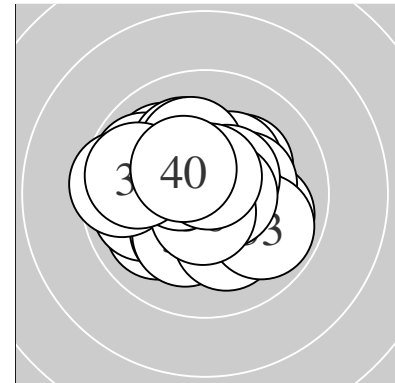

Serie 1:  
 10.0 ↘                      10.7 \*                      10.6 \*                      10.0 ↙                      10.4 \*  
 10.4 \*                      10.4 \*                      9.9 →                      10.3 \*                      10.4 \*  
 beste Teiler 64.9 (2.) 88.0 (3.) 128.3 (5.)  
 Trefferlage 0.52 mm links, 0.11 mm hoch  
 Streuwert 1.22, horizontal: 1.45, vertikal: 0.93

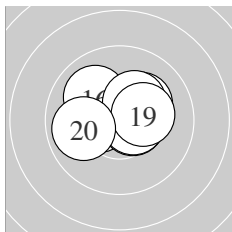

Serie 2:  
 10.4 \*                      10.6 \*                      10.6 \*                      10.6 \*                      10.2 \*  
 10.0 ↘                      10.6 \*                      10.3 \*                      10.3 \*                      9.9 ←  
 beste Teiler 82.8 (12.) 89.0 (13.) 96.5 (14.)  
 Trefferlage 0.07 mm rechts, 0.43 mm hoch  
 Streuwert 1.18, horizontal: 1.49, vertikal: 0.74

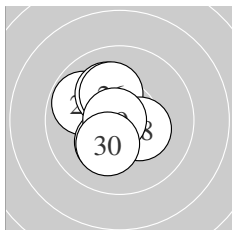

Serie 3:  
 10.2 \*                      9.8 ↘                      10.1 ↖                      10.6 \*                      10.8 \*  
 10.2 \*                      10.2 \*                      10.3 \*                      10.8 \*                      10.2 \*  
 beste Teiler 35.0 (29.) 46.2 (25.) 83.2 (24.)  
 Trefferlage 0.64 mm links, 0.13 mm hoch  
 Streuwert 1.18, horizontal: 0.99, vertikal: 1.35

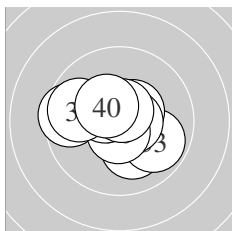

Serie 4:  
 10.1 ↘                      9.5 ←                      9.9 →                      10.5 \*                      10.6 \*  
 10.6 \*                      10.5 \*                      10.7 \*                      9.8 ←                      10.4 \*  
 beste Teiler 75.7 (38.) 76.5 (36.) 82.1 (35.)  
 Trefferlage 0.32 mm links, 0.03 mm hoch  
 Streuwert 1.46, horizontal: 1.80, vertikal: 1.02

Unterschrift des Schuetzen

Meyton Elektronik