

Ergebnis: **416.1** (398)  
 Serien: 103.8 104.1 104.7 103.5  
 Zaehler: 38 2 0 0 0 0 0 0 0 0  
 Innenzehner: 32  
 weiteste: 262 (4), 261 (16), 244 (34)  
 beste Teiler 12.8 (21.) 17.8 (6.) 54.9 (29.)  
 Trefferlage 0.19 mm links, 0.28 mm hoch  
 Streuwert 1.06, horizontal: 1.16, vertikal: 0.95

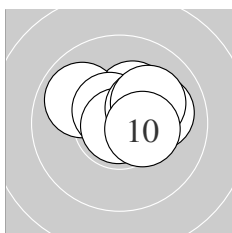

Serie 1:  
 10.6 \* 10.7 \* 10.3 \* 9.9 ↘ 10.6 \*  
 10.9 \* 10.3 \* 10.0 → 10.1 ↗ 10.4 \*  
 beste Teiler 17.8 (6.) 73.4 (2.) 87.9 (1.)  
 Trefferlage 0.51 mm rechts, 0.66 mm hoch  
 Streuwert 1.03, horizontal: 1.31, vertikal: 0.65

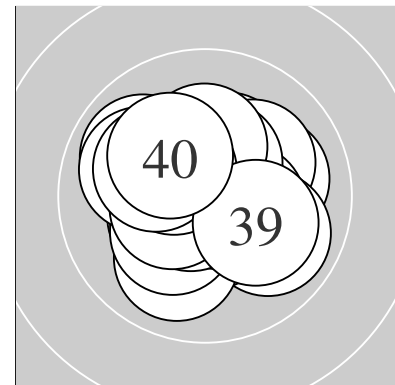
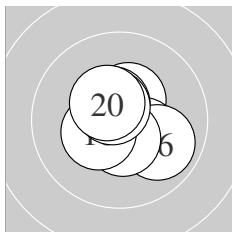

Serie 2:  
 10.5 \* 10.6 \* 10.4 \* 10.3 \* 10.5 \*  
 9.9 ↘ 10.5 \* 10.4 \* 10.6 \* 10.4 \*  
 beste Teiler 77.0 (12.) 89.0 (19.) 103.3 (15.)  
 Trefferlage 0.19 mm rechts, 0.16 mm hoch  
 Streuwert 1.03, horizontal: 1.03, vertikal: 1.03

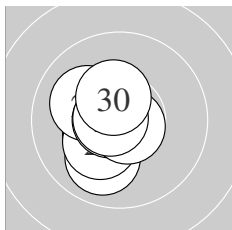

Serie 3:  
 10.9 \* 10.4 \* 10.0 ↙ 10.3 \* 10.5 \*  
 10.1 ↘ 10.7 \* 10.7 \* 10.7 \* 10.4 \*  
 beste Teiler 12.8 (21.) 54.9 (29.) 58.0 (27.)  
 Trefferlage 0.70 mm links, 0.16 mm tief  
 Streuwert 0.90, horizontal: 0.66, vertikal: 1.08

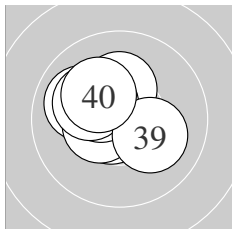

Serie 4:  
 10.5 \* 10.7 \* 10.7 \* 10.0 ↘ 10.5 \*  
 10.2 \* 10.4 \* 10.2 \* 10.1 ↘ 10.2 \*  
 beste Teiler 57.8 (32.) 67.3 (33.) 119.7 (31.)  
 Trefferlage 0.76 mm links, 0.47 mm hoch  
 Streuwert 1.02, horizontal: 1.11, vertikal: 0.91

Unterschrift des Schuetzen

Meyton Elektronik

Ergebnis: **351.5** (332)  
 Serien: 89.6 82.7 88.4 90.8  
 Zaehler: 5 16 11 7 0 0 0 0 0 1  
 Innenzehner: 3  
 weiteste: 2466 (18), 911 (27), 885 (32)  
 beste Teiler 153.4 (36.) 171.3 (19.) 174.2 (21.)  
 Trefferlage 0.38 mm rechts, 0.10 mm tief  
 Streuwert 4.73, horizontal: 5.27, vertikal: 4.12

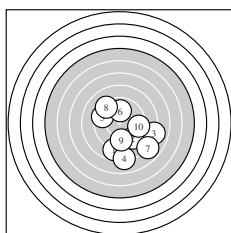
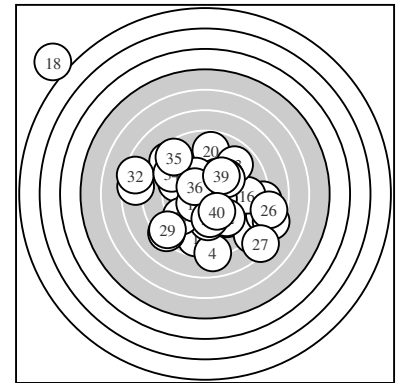

Serie 1:  
 8.7 ↓                      9.3 ↘                      8.0 →                      8.0 ↓                      9.5 ↖  
 9.9 ↑                      7.9 ↘                      9.3 ↖                      9.6 ↓                      9.4 →  
 beste Teiler 253.4 (6.) 343.7 (9.) 373.4 (5.)  
 Trefferlage 1.34 mm rechts, 1.96 mm tief  
 Streuwert 3.50, horizontal: 3.48, vertikal: 3.53

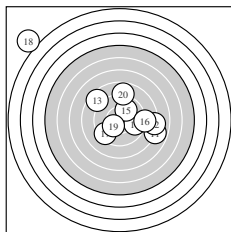

Serie 2:  
 7.9 →                      8.1 →                      8.5 ↖                      9.7 →                      10.0 ↗  
 8.9 →                      9.4 ↙                      1.1 ↖                      10.3 \*                      8.8 ↑  
 beste Teiler 171.3 (19.) 243.2 (15.) 320.8 (14.)  
 Trefferlage 0.27 mm links, 1.94 mm hoch  
 Streuwert 6.70, horizontal: 7.60, vertikal: 5.66

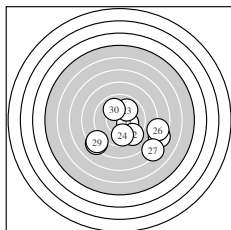

Serie 3:  
 10.3 \*                      9.4 ↘                      9.9 ↗                      9.7 ↓                      7.4 →  
 7.7 →                      7.3 ↘                      8.3 ↙                      8.4 ↙                      10.0 ↖  
 beste Teiler 174.2 (21.) 244.1 (30.) 253.3 (23.)  
 Trefferlage 1.85 mm rechts, 2.28 mm tief  
 Streuwert 3.83, horizontal: 4.65, vertikal: 2.77

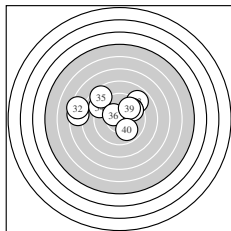

Serie 4:  
 7.5 ←                      7.4 ←                      8.9 ↗                      9.0 ↖                      8.6 ↖  
 10.3 \*                      9.7 ↗                      9.7 ↗                      9.8 ↗                      9.9 ↘  
 beste Teiler 153.4 (36.) 257.6 (40.) 298.8 (39.)  
 Trefferlage 1.39 mm links, 1.86 mm hoch  
 Streuwert 3.49, horizontal: 4.60, vertikal: 1.78

Unterschrift des Schuetzen

Meyton Elektronik

Ergebnis: **407.4** (390)  
 Serien: 102.3 101.0 100.9 103.2  
 Zaehler: 30 10 0 0 0 0 0 0 0 0  
 Innenzehner: 23  
 weiteste: 427 (29), 318 (16), 318 (32)  
 beste Teiler 16.6 (27.) 55.2 (39.) 74.1 (17.)  
 Trefferlage 0.64 mm links, 0.09 mm hoch  
 Streuwert 1.43, horizontal: 1.20, vertikal: 1.62

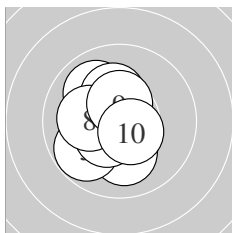
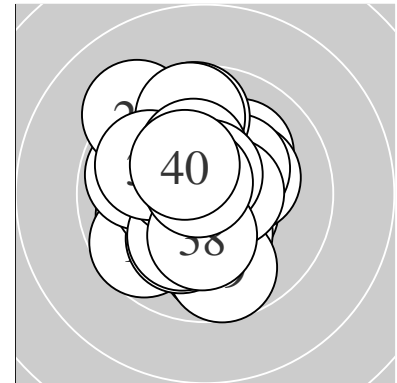

Serie 1:  
 10.2 \* 10.1 ↓ 9.8 ↙ 10.5 \* 10.4 \*  
 10.0 ↘ 10.2 \* 10.1 ← 10.5 \* 10.5 \*  
 beste Teiler 104.6 (10.) 121.0 (9.) 124.4 (4.)  
 Trefferlage 0.68 mm links, 0.15 mm tief  
 Streuwert 1.31, horizontal: 1.05, vertikal: 1.53

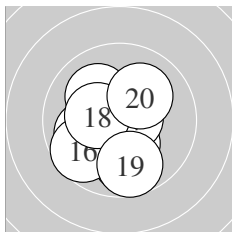

Serie 2:  
 9.9 ↓ 10.1 ↘ 10.0 ↙ 10.2 \* 10.3 \*  
 9.7 ↙ 10.7 \* 10.3 \* 9.7 ↓ 10.1 ↗  
 beste Teiler 74.1 (17.) 154.1 (18.) 168.2 (15.)  
 Trefferlage 0.43 mm links, 0.82 mm tief  
 Streuwert 1.54, horizontal: 1.39, vertikal: 1.68

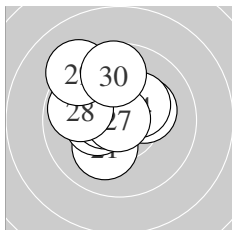

Serie 3:  
 10.1 ↙ 10.2 \* 9.9 ↖ 10.3 \* 10.3 \*  
 10.5 \* 10.9 \* 9.8 ↖ 9.2 ↘ 9.7 ↑  
 beste Teiler 16.6 (27.) 103.8 (26.) 151.9 (25.)  
 Trefferlage 0.90 mm links, 0.79 mm hoch  
 Streuwert 1.52, horizontal: 1.54, vertikal: 1.50

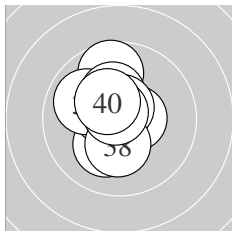

Serie 4:  
 10.2 \* 9.7 ↑ 10.5 \* 9.9 ↖ 10.6 \*  
 10.3 \* 10.6 \* 10.3 \* 10.7 \* 10.4 \*  
 beste Teiler 55.2 (39.) 80.7 (37.) 99.1 (35.)  
 Trefferlage 0.54 mm links, 0.56 mm hoch  
 Streuwert 1.19, horizontal: 0.84, vertikal: 1.46

Unterschrift des Schuetzen

Meyton Elektronik

Ergebnis: **398.7** (383)  
 Serien: 98.9 101.2 99.4 99.2  
 Zaehler: 23 17 0 0 0 0 0 0 0 0  
 Innenzehner: 15  
 weiteste: 498 (26), 451 (36), 450 (2)  
 beste Teiler 68.0 (15.) 82.4 (3.) 100.9 (31.)  
 Trefferlage 0.14 mm links, 0.45 mm tief  
 Streuwert 1.89, horizontal: 1.70, vertikal: 2.07

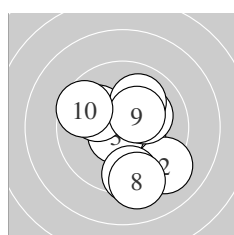
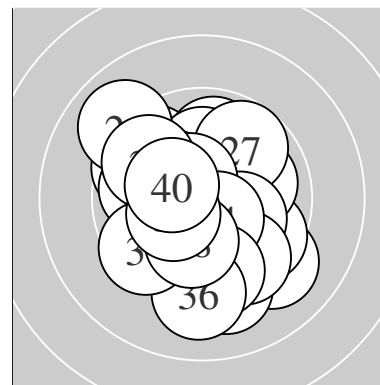

Serie 1:  
 10.4 \* 9.2 ↘ 10.6 \* 10.2 \* 9.4 ↓  
 10.0 ↖ 10.0 ↗ 9.2 ↓ 10.3 \* 9.6 ↖  
 beste Teiler 82.4 (3.) 149.6 (1.) 151.6 (9.)  
 Trefferlage 0.48 mm rechts, 0.61 mm tief  
 Streuwert 2.09, horizontal: 1.86, vertikal: 2.30

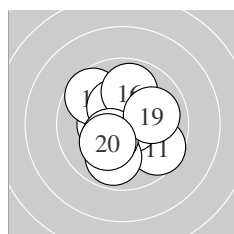

Serie 2:  
 9.6 ↘ 10.4 \* 9.7 ↖ 10.4 \* 10.7 \*  
 9.9 ↑ 9.9 ↓ 10.4 \* 10.0 → 10.2 \*  
 beste Teiler 68.0 (15.) 138.1 (12.) 140.0 (18.)  
 Trefferlage 0.09 mm links, 0.00 mm  
 Streuwert 1.69, horizontal: 1.64, vertikal: 1.73

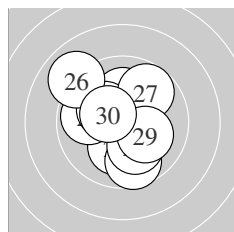

Serie 3:  
 10.1 ↓ 9.7 ↓ 10.1 ↑ 9.9 ← 10.3 \*  
 9.0 ↖ 9.7 ↗ 10.1 ↓ 10.1 ↘ 10.4 \*  
 beste Teiler 132.4 (30.) 173.1 (25.) 202.0 (21.)  
 Trefferlage 0.39 mm links, 0.19 mm hoch  
 Streuwert 2.00, horizontal: 1.86, vertikal: 2.12

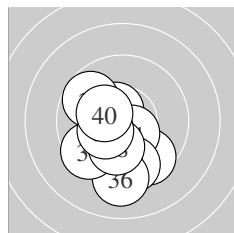

Serie 4:  
 10.6 \* 9.7 ↖ 9.6 ↘ 10.5 \* 9.5 ↓  
 9.1 ↓ 9.5 ↗ 10.1 ↓ 10.3 \* 10.3 \*  
 beste Teiler 100.9 (31.) 120.4 (34.) 156.3 (40.)  
 Trefferlage 0.58 mm links, 1.38 mm tief  
 Streuwert 1.77, horizontal: 1.48, vertikal: 2.02

Unterschrift des Schuetzen

Meyton Elektronik

Ergebnis: **392.5** (377)  
 Serien: 97.9 102.9 98.2 93.5  
 Zaehler: 22 14 3 1 0 0 0 0 0 0  
 Innenzehner: 18  
 weiteste: 890 (26), 676 (33), 604 (10)  
 beste Teiler 48.7 (23.) 50.9 (21.) 81.7 (1.)  
 Trefferlage 1.82 mm links, 0.01 mm tief  
 Streuwert 2.06, horizontal: 2.59, vertikal: 1.34

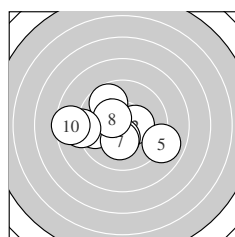
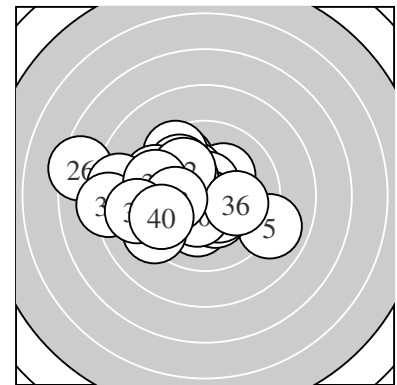

Serie 1:  
 10.6 \*                      10.4 \*                      10.4 \*                      9.7 ←                      9.0 →  
 9.7 ↘                      10.2 \*                      10.4 \*                      9.0 ←                      8.5 ←  
 beste Teiler 81.7 (1.) 145.1 (2.) 145.6 (8.)  
 Trefferlage 1.22 mm links, 0.24 mm tief  
 Streuwert 2.34, horizontal: 3.02, vertikal: 1.36

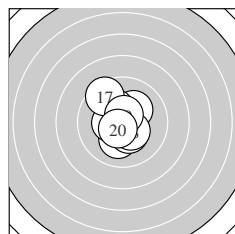

Serie 2:  
 10.6 \*                      10.2 \*                      10.1 ↓                      10.3 \*                      10.2 \*  
 10.4 \*                      9.5 ↘                      10.4 \*                      10.6 \*                      10.6 \*  
 beste Teiler 86.3 (19.) 89.8 (11.) 93.6 (20.)  
 Trefferlage 0.31 mm links, 0.20 mm hoch  
 Streuwert 1.33, horizontal: 1.07, vertikal: 1.54

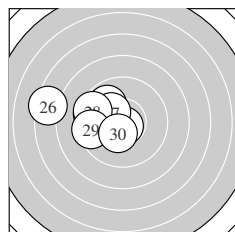

Serie 3:  
 10.8 \*                      9.5 ←                      10.8 \*                      9.9 ↘                      10.2 \*  
 7.4 ←                      10.3 \*                      9.5 ←                      9.4 ←                      10.4 \*  
 beste Teiler 48.7 (23.) 50.9 (21.) 140.7 (30.)  
 Trefferlage 2.46 mm links, 0.37 mm hoch  
 Streuwert 2.03, horizontal: 2.60, vertikal: 1.23

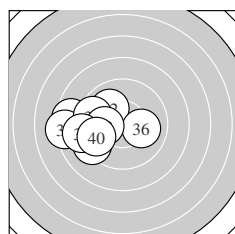

Serie 4:  
 8.5 ←                      10.0 ↘                      8.2 ←                      9.3 ←                      9.2 ↙  
 10.1 →                      9.5 ←                      10.1 ←                      9.0 ←                      9.6 ←  
 beste Teiler 210.1 (38.) 222.9 (36.) 235.0 (32.)  
 Trefferlage 3.28 mm links, 0.38 mm tief  
 Streuwert 1.98, horizontal: 2.50, vertikal: 1.26

Unterschrift des Schuetzen

Meyton Elektronik

Ergebnis: **416.9** (399)  
 Serien: 104.5 103.1 105.2 104.1  
 Zaehler: 39 1 0 0 0 0 0 0 0 0  
 Innenzehner: 36  
 weiteste: 288 (16), 238 (38), 229 (37)  
 beste Teiler 8.9 (24.) 37.2 (25.) 51.8 (29.)  
 Trefferlage 0.36 mm links, 0.08 mm hoch  
 Streuwert 1.00, horizontal: 0.86, vertikal: 1.12

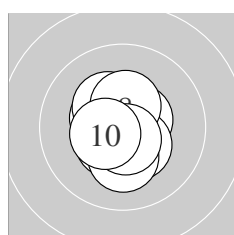
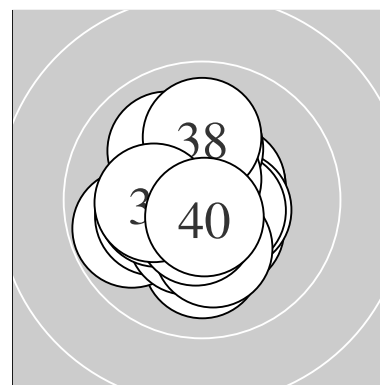

Serie 1:  
 10.6 \*                      10.5 \*                      10.4 \*                      10.5 \*                      10.3 \*  
 10.5 \*                      10.2 \*                      10.4 \*                      10.6 \*                      10.5 \*  
 beste Teiler 79.5 (9.) 94.3 (1.) 104.2 (2.)  
 Trefferlage 0.10 mm links, 0.21 mm tief  
 Streuwert 0.95, horizontal: 0.81, vertikal: 1.07

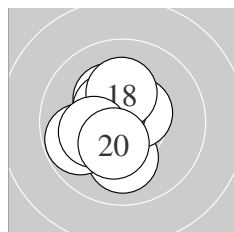

Serie 2:  
 10.4 \*                      10.3 \*                      10.1 ↓                      10.7 \*                      10.5 \*  
 9.8 ←                      10.5 \*                      10.2 \*                      10.2 \*                      10.4 \*  
 beste Teiler 52.6 (14.) 108.4 (17.) 124.5 (15.)  
 Trefferlage 0.62 mm links, 0.14 mm hoch  
 Streuwert 1.21, horizontal: 1.02, vertikal: 1.38

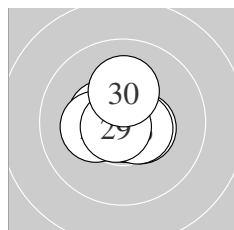

Serie 3:  
 10.5 \*                      10.4 \*                      10.5 \*                      10.9 \*                      10.8 \*  
 10.5 \*                      10.4 \*                      10.3 \*                      10.7 \*                      10.2 \*  
 beste Teiler 8.9 (24.) 37.2 (25.) 51.8 (29.)  
 Trefferlage 0.26 mm links, 0.17 mm hoch  
 Streuwert 0.86, horizontal: 0.94, vertikal: 0.77

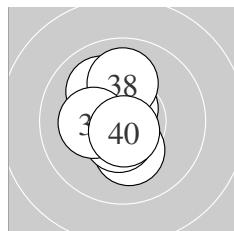

Serie 4:  
 10.6 \*                      10.6 \*                      10.6 \*                      10.7 \*                      10.2 \*  
 10.5 \*                      10.0 ↘                      10.0 ↑                      10.2 \*                      10.7 \*  
 beste Teiler 57.5 (34.) 65.6 (40.) 76.0 (32.)  
 Trefferlage 0.47 mm links, 0.23 mm hoch  
 Streuwert 1.02, horizontal: 0.70, vertikal: 1.27

Unterschrift des Schuetzen

Meyton Elektronik

Ergebnis: **411.7** (395)  
 Serien: 103.0 103.2 101.9 103.6  
 Zaehler: 35 5 0 0 0 0 0 0 0 0  
 Innenzehner: 27  
 weiteste: 334 (5), 331 (3), 323 (13)  
 beste Teiler 1.4 (15.) 39.0 (35.) 48.9 (9.)  
 Trefferlage 0.35 mm links, 0.03 mm tief  
 Streuwert 1.30, horizontal: 1.37, vertikal: 1.22

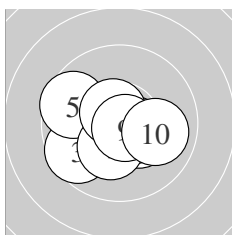
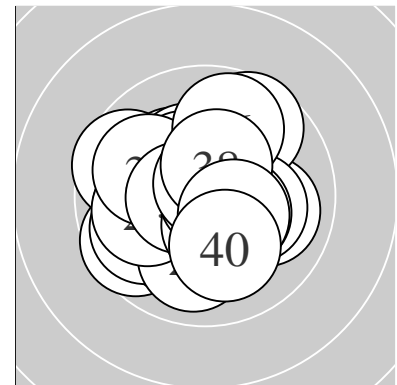

Serie 1:  
 10.4 \* 10.5 \* 9.6 ↙ 10.7 \* 9.6 ↖  
 10.5 \* 10.3 \* 10.6 \* 10.8 \* 10.0 →  
 beste Teiler 48.9 (9.) 64.5 (4.) 85.2 (8.)  
 Trefferlage 0.35 mm links, 0.39 mm tief  
 Streuwert 1.38, horizontal: 1.72, vertikal: 0.91

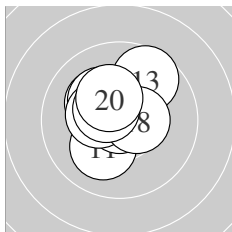

Serie 2:  
 10.1 ↘ 10.2 \* 9.7 ↗ 10.4 \* 10.9 \*  
 10.2 \* 10.4 \* 10.5 \* 10.5 \* 10.3 \*  
 beste Teiler 1.4 (15.) 114.0 (18.) 117.1 (19.)  
 Trefferlage 0.50 mm links, 0.66 mm hoch  
 Streuwert 1.14, horizontal: 1.11, vertikal: 1.18

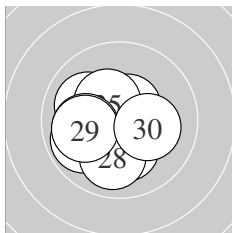

Serie 3:  
 10.6 \* 10.6 \* 10.0 ↖ 10.2 \* 10.4 \*  
 10.0 ← 9.9 ↙ 10.0 ↓ 10.0 ← 10.2 \*  
 beste Teiler 99.8 (22.) 100.3 (21.) 143.6 (25.)  
 Trefferlage 0.79 mm links, 0.50 mm tief  
 Streuwert 1.35, horizontal: 1.47, vertikal: 1.21

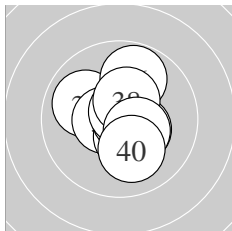

Serie 4:  
 10.0 ↖ 10.6 \* 10.4 \* 10.4 \* 10.8 \*  
 9.8 ↗ 10.7 \* 10.4 \* 10.4 \* 10.1 ↘  
 beste Teiler 39.0 (35.) 52.4 (37.) 95.2 (32.)  
 Trefferlage 0.23 mm rechts, 0.07 mm hoch  
 Streuwert 1.22, horizontal: 1.08, vertikal: 1.35

Unterschrift des Schuetzen

Ergebnis: **414.3** (394)  
 Serien: 102.1 105.1 103.7 103.4  
 Zaehler: 34 6 0 0 0 0 0 0 0 0  
 Innenzehner: 32  
 weiteste: 413 (4), 406 (38), 359 (22)  
 beste Teiler 16.6 (24.) 17.4 (13.) 37.6 (37.)  
 Trefferlage 0.47 mm links, 0.16 mm hoch  
 Streuwert 1.23, horizontal: 1.40, vertikal: 1.04

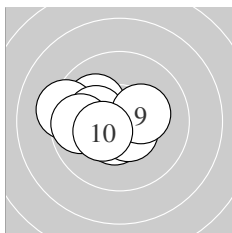
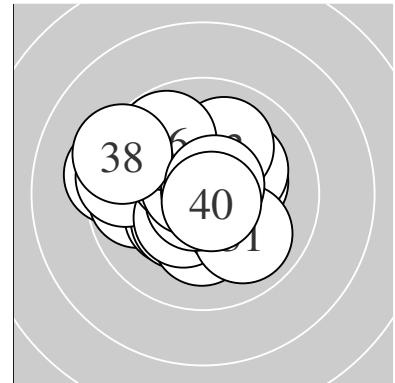

Serie 1:  
 10.2 \*                      10.1 ↘                      10.5 \*                      9.3 ←                      10.8 \*  
 10.5 \*                      10.2 \*                      9.8 ←                      10.3 \*                      10.4 \*  
 beste Teiler 38.9 (5.) 102.3 (6.) 111.3 (3.)  
 Trefferlage 1.18 mm links, 0.05 mm hoch  
 Streuwert 1.31, horizontal: 1.67, vertikal: 0.79

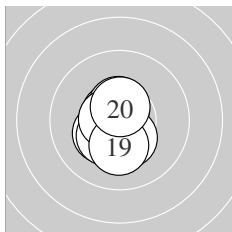

Serie 2:  
 10.3 \*                      10.7 \*                      10.9 \*                      10.6 \*                      10.3 \*  
 10.5 \*                      10.6 \*                      10.4 \*                      10.2 \*                      10.6 \*  
 beste Teiler 17.4 (13.) 69.0 (12.) 77.9 (14.)  
 Trefferlage 0.35 mm links, 0.21 mm tief  
 Streuwert 0.85, horizontal: 0.58, vertikal: 1.06

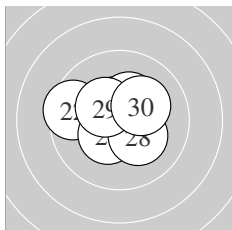

Serie 3:  
 10.8 \*                      9.5 ←                      10.5 \*                      10.9 \*                      10.5 \*  
 10.4 \*                      10.3 \*                      10.2 \*                      10.4 \*                      10.2 \*  
 beste Teiler 16.6 (24.) 39.5 (21.) 106.0 (23.)  
 Trefferlage 0.13 mm links, 0.22 mm hoch  
 Streuwert 1.25, horizontal: 1.50, vertikal: 0.94

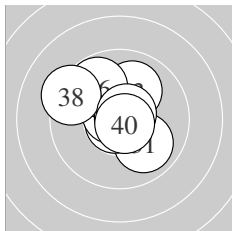

Serie 4:  
 9.9 ↘                      10.6 \*                      10.0 ↗                      10.8 \*                      10.7 \*  
 9.8 ↘                      10.8 \*                      9.3 ↘                      10.7 \*                      10.8 \*  
 beste Teiler 37.6 (37.) 47.4 (34.) 50.9 (40.)  
 Trefferlage 0.21 mm links, 0.57 mm hoch  
 Streuwert 1.41, horizontal: 1.52, vertikal: 1.29

Unterschrift des Schuetzen

Meyton Elektronik



Ergebnis: **399.4** (384)  
 Serien: 98.6 98.4 102.2 100.2  
 Zaehler: 25 14 1 0 0 0 0 0 0 0  
 Innenzehner: 15  
 weiteste: 657 (17), 484 (15), 482 (3)  
 beste Teiler 66.8 (2.) 93.1 (39.) 100.3 (13.)  
 Trefferlage 0.55 mm links, 0.27 mm tief  
 Streuwert 1.90, horizontal: 2.11, vertikal: 1.67

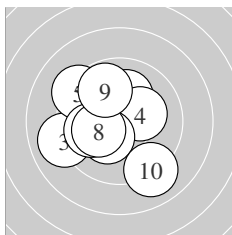
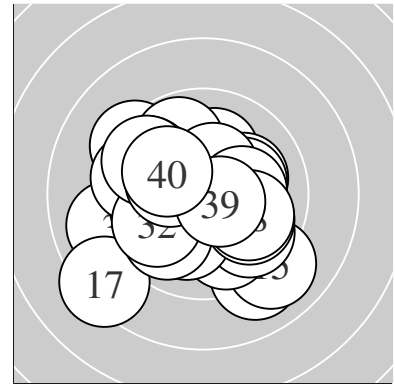

Serie 1:  
 10.1 ↑ 10.7 \* 9.0 ← 10.2 \* 9.3 ↖  
 10.3 \* 10.0 ← 10.2 \* 9.8 ↗ 9.0 ↘  
 beste Teiler 66.8 (2.) 164.0 (6.) 180.6 (4.)  
 Trefferlage 0.97 mm links, 0.01 mm tief  
 Streuwert 2.14, horizontal: 2.21, vertikal: 2.07

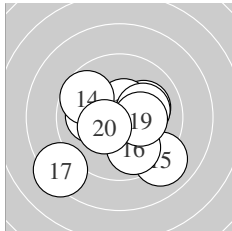

Serie 2:  
 10.1 → 10.1 ← 10.6 \* 9.7 ↖ 9.0 ↘  
 9.8 ↘ 8.3 ↙ 10.1 → 10.3 \* 10.4 \*  
 beste Teiler 100.3 (13.) 149.2 (20.) 172.7 (19.)  
 Trefferlage 0.06 mm links, 0.72 mm tief  
 Streuwert 2.34, horizontal: 2.62, vertikal: 2.03

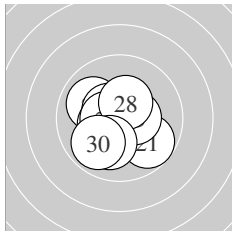

Serie 3:  
 9.8 ↘ 10.0 ↖ 10.5 \* 10.1 ↙ 10.5 \*  
 10.4 \* 10.5 \* 10.4 \* 10.1 ↙ 9.9 ↙  
 beste Teiler 104.0 (27.) 109.6 (23.) 122.0 (25.)  
 Trefferlage 0.51 mm links, 0.52 mm tief  
 Streuwert 1.38, horizontal: 1.41, vertikal: 1.35

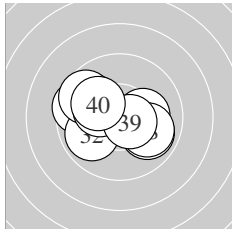

Serie 4:  
 9.6 ↖ 9.9 ↙ 10.0 ↖ 9.9 ↘ 9.7 ↖  
 10.2 \* 10.3 \* 9.9 ↘ 10.6 \* 10.1 ↖  
 beste Teiler 93.1 (39.) 174.0 (37.) 193.4 (36.)  
 Trefferlage 0.66 mm links, 0.14 mm hoch  
 Streuwert 1.77, horizontal: 2.24, vertikal: 1.11

Unterschrift des Schuetzen

Meyton Elektronik

Ergebnis: **384.4** (368)

Serien: 94.5 97.0 93.9 99.0

Zaehler: 14 20 6 0 0 0 0 0 0 0

Innenzehner: 9

weiteste: 718 (7), 598 (36), 569 (23)

beste Teiler 45.3 (13.) 87.6 (39.) 91.0 (40.)

Trefferlage 0.63 mm rechts, 0.33 mm hoch

Streuwert 2.61, horizontal: 2.66, vertikal: 2.55

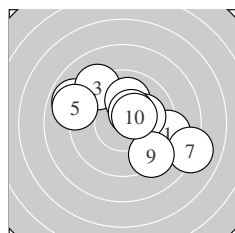
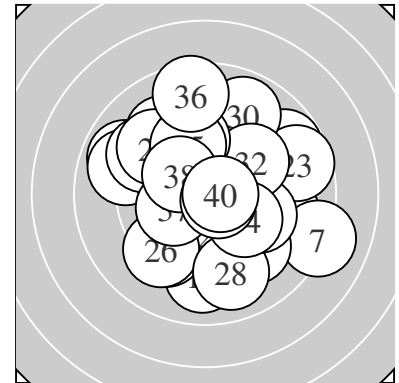

Serie 1:

9.1 →	8.9 ↖	9.2 ↘	10.0 ↑	9.0 ↖
10.1 →	8.1 →	10.4 *	9.3 ↘	10.4 *

beste Teiler 134.9 (10.) 136.0 (8.) 211.2 (6.)

Trefferlage 0.65 mm rechts, 0.52 mm hoch

Streuwert 3.04, horizontal: 3.73, vertikal: 2.15

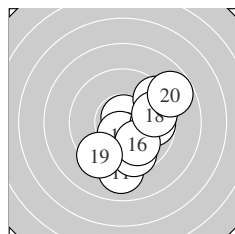

Serie 2:

9.0 ↓	9.6 ↓	10.8 *	10.5 *	9.8 →
10.0 ↘	9.4 ↗	9.7 →	9.4 ↙	8.8 ↗

beste Teiler 45.3 (13.) 121.8 (14.) 250.8 (16.)

Trefferlage 1.40 mm rechts, 0.82 mm tief

Streuwert 2.31, horizontal: 2.12, vertikal: 2.49

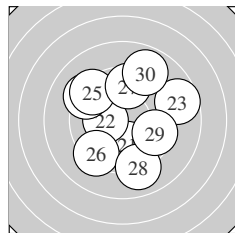

Serie 3:

10.0 ↓	10.3 *	8.7 →	9.2 ↖	9.3 ↖
9.3 ↙	9.6 ↑	9.0 ↓	9.6 →	8.9 ↑

beste Teiler 169.0 (22.) 243.6 (21.) 340.3 (27.)

Trefferlage 0.25 mm rechts, 0.34 mm hoch

Streuwert 3.03, horizontal: 2.94, vertikal: 3.12

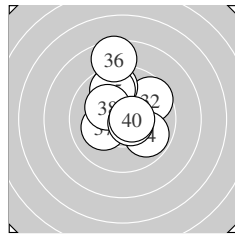

Serie 4:

10.2 *	9.6 ↗	9.6 ↑	9.8 ↘	9.7 ↑
8.6 ↑	10.1 ↖	10.2 *	10.6 *	10.6 *

beste Teiler 87.6 (39.) 91.0 (40.) 179.7 (31.)

Trefferlage 0.24 mm rechts, 1.31 mm hoch

Streuwert 1.96, horizontal: 1.64, vertikal: 2.23

Unterschrift des Schuetzen

Meyton Elektronik

Ergebnis: **413.1** (396)  
 Serien: 103.1 102.8 103.9 103.3  
 Zaehler: 36 4 0 0 0 0 0 0 0 0  
 Innenzehner: 27  
 weiteste: 300 (23), 295 (34), 264 (3)  
 beste Teiler 17.0 (29.) 18.0 (21.) 60.7 (40.)  
 Trefferlage 0.12 mm links, 0.17 mm hoch  
 Streuwert 1.22, horizontal: 1.22, vertikal: 1.23

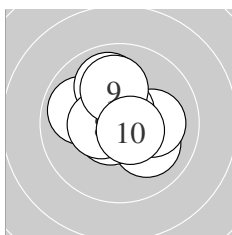
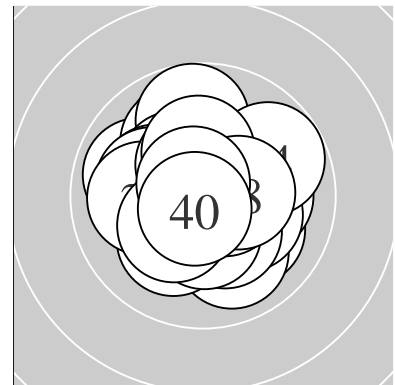

Serie 1:  
 10.7 \*                      10.1 ↘                      9.9 ↖                      9.9 ↑                      10.6 \*  
 10.1 →                      10.6 \*                      10.5 \*                      10.1 ↑                      10.6 \*  
 beste Teiler 70.0 (1.) 76.1 (7.) 77.9 (5.)  
 Trefferlage 0.02 mm links, 0.33 mm hoch  
 Streuwert 1.31, horizontal: 1.39, vertikal: 1.22

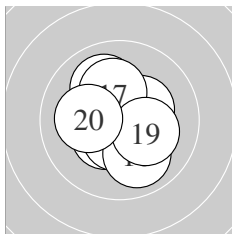

Serie 2:  
 10.4 \*                      10.5 \*                      10.6 \*                      10.5 \*                      10.0 ↗  
 10.3 \*                      10.2 \*                      10.0 ↘                      10.2 \*                      10.1 ←  
 beste Teiler 86.2 (13.) 106.0 (14.) 112.3 (12.)  
 Trefferlage 0.04 mm links, 0.16 mm hoch  
 Streuwert 1.29, horizontal: 1.18, vertikal: 1.40

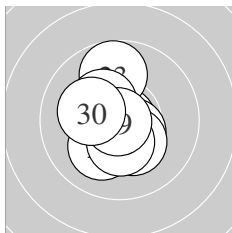

Serie 3:  
 10.9 \*                      10.5 \*                      9.8 ↑                      10.1 ↙                      10.3 \*  
 10.5 \*                      10.3 \*                      10.4 \*                      10.9 \*                      10.2 \*  
 beste Teiler 17.0 (29.) 18.0 (21.) 105.7 (22.)  
 Trefferlage 0.20 mm links, 0.16 mm tief  
 Streuwert 1.21, horizontal: 0.92, vertikal: 1.43

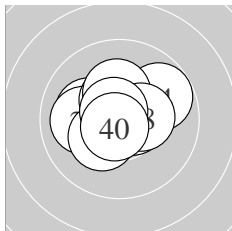

Serie 4:  
 10.1 ↖                      10.0 ←                      10.6 \*                      9.8 ↗                      10.4 \*  
 10.3 \*                      10.3 \*                      10.4 \*                      10.7 \*                      10.7 \*  
 beste Teiler 60.7 (40.) 63.4 (39.) 85.1 (33.)  
 Trefferlage 0.20 mm links, 0.36 mm hoch  
 Streuwert 1.24, horizontal: 1.50, vertikal: 0.91

Unterschrift des Schuetzen

Meyton Elektronik

Ergebnis: **412.9** (395)  
 Serien: 103.2 103.5 102.2 104.0  
 Zaehler: 35 5 0 0 0 0 0 0 0 0  
 Innenzehner: 29  
 weiteste: 360 (5), 320 (24), 312 (14)  
 beste Teiler 32.6 (4.) 46.2 (13.) 48.1 (11.)  
 Trefferlage 0.31 mm rechts, 0.03 mm tief  
 Streuwert 1.25, horizontal: 1.33, vertikal: 1.17

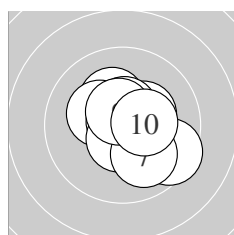
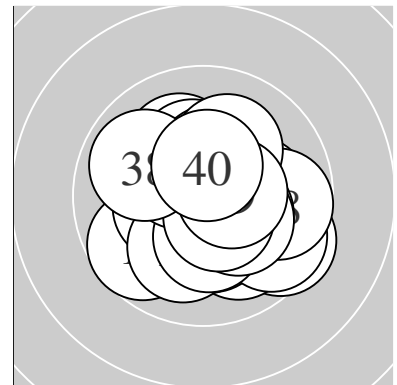

Serie 1:  
 10.2 \*                      10.3 \*                      10.3 \*                      10.8 \*                      9.5 ↘  
 10.6 \*                      10.0 ↘                      10.5 \*                      10.6 \*                      10.4 \*  
 beste Teiler 32.6 (4.) 93.3 (6.) 94.3 (9.)  
 Trefferlage 0.46 mm rechts, 0.08 mm hoch  
 Streuwert 1.30, horizontal: 1.36, vertikal: 1.22

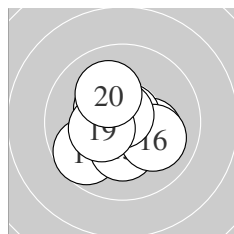

Serie 2:  
 10.8 \*                      10.2 \*                      10.8 \*                      9.7 ↙                      10.3 \*  
 10.0 ↘                      10.4 \*                      10.8 \*                      10.4 \*                      10.1 ↘  
 beste Teiler 46.2 (13.) 48.1 (11.) 50.0 (18.)  
 Trefferlage 0.21 mm links, 0.17 mm tief  
 Streuwert 1.29, horizontal: 1.37, vertikal: 1.20

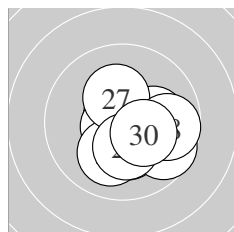

Serie 3:  
 10.3 \*                      10.1 →                      10.7 \*                      9.7 ↘                      10.7 \*  
 10.1 ↙                      10.3 \*                      9.7 →                      10.3 \*                      10.3 \*  
 beste Teiler 53.9 (23.) 67.0 (25.) 158.7 (30.)  
 Trefferlage 0.75 mm rechts, 0.61 mm tief  
 Streuwert 1.31, horizontal: 1.44, vertikal: 1.16

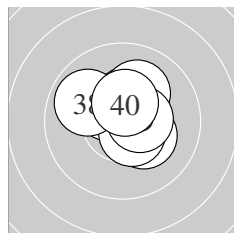

Serie 4:  
 10.4 \*                      10.7 \*                      10.4 \*                      10.7 \*                      10.1 ↗  
 10.3 \*                      10.5 \*                      9.9 ↘                      10.5 \*                      10.5 \*  
 beste Teiler 56.0 (34.) 70.4 (32.) 102.4 (37.)  
 Trefferlage 0.25 mm rechts, 0.54 mm hoch  
 Streuwert 1.04, horizontal: 1.12, vertikal: 0.95

Unterschrift des Schuetzen

Meyton Elektronik

Ergebnis: **405.8** (389)  
 Serien: 98.1 101.5 103.4 102.8  
 Zaehler: 29 11 0 0 0 0 0 0 0 0  
 Innenzehner: 21  
 weiteste: 497 (8), 449 (3), 379 (4)  
 beste Teiler 17.7 (40.) 54.6 (24.) 64.1 (31.)  
 Trefferlage 0.18 mm rechts, 0.05 mm tief  
 Streuwert 1.63, horizontal: 1.93, vertikal: 1.27

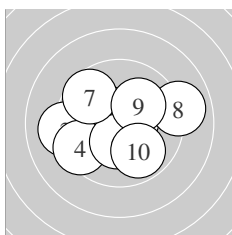
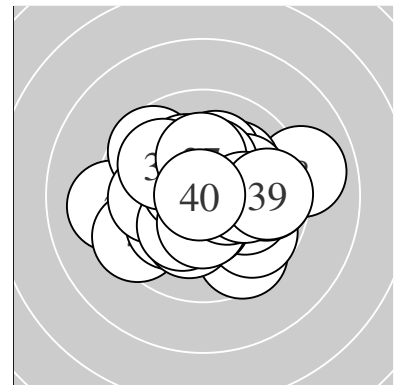

Serie 1:  
 10.2 \*                      9.8 ←                      9.2 ←                      9.4 ↙                      10.6 \*  
 10.3 \*                      9.6 ↘                      9.0 →                      10.1 ↗                      9.9 ↘  
 beste Teiler 100.8 (5.) 152.7 (6.) 183.0 (1.)  
 Trefferlage 0.59 mm links, 0.03 mm tief  
 Streuwert 2.29, horizontal: 2.85, vertikal: 1.53

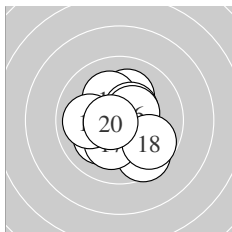

Serie 2:  
 10.1 ↖                      9.6 ↘                      10.1 ↑                      10.2 \*                      10.4 \*  
 10.5 \*                      10.2 \*                      9.7 ↘                      10.0 ←                      10.7 \*  
 beste Teiler 75.9 (20.) 120.4 (16.) 127.3 (15.)  
 Trefferlage 0.06 mm rechts, 0.28 mm tief  
 Streuwert 1.60, horizontal: 1.57, vertikal: 1.62

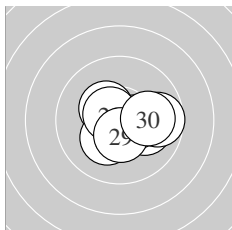

Serie 3:  
 10.7 \*                      10.1 →                      10.4 \*                      10.7 \*                      10.5 \*  
 9.7 →                      10.2 \*                      10.6 \*                      10.5 \*                      10.0 →  
 beste Teiler 54.6 (24.) 69.6 (21.) 91.5 (28.)  
 Trefferlage 0.58 mm rechts, 0.29 mm tief  
 Streuwert 1.19, horizontal: 1.51, vertikal: 0.74

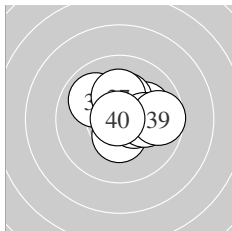

Serie 4:  
 10.7 \*                      10.4 \*                      10.1 ↗                      10.3 \*                      10.5 \*  
 9.9 ↘                      10.2 \*                      10.1 →                      9.7 →                      10.9 \*  
 beste Teiler 17.7 (40.) 64.1 (31.) 120.0 (35.)  
 Trefferlage 0.66 mm rechts, 0.37 mm hoch  
 Streuwert 1.28, horizontal: 1.47, vertikal: 1.05

Unterschrift des Schuetzen

Meyton Elektronik

Ergebnis: **402.4** (385)  
 Serien: 100.3 101.1 100.0 101.0  
 Zaehler: 25 15 0 0 0 0 0 0 0  
 Innenzehner: 17  
 weiteste: 476 (18), 465 (3), 366 (6)  
 beste Teiler 29.2 (17.) 39.8 (10.) 63.7 (16.)  
 Trefferlage 0.25 mm rechts, 0.35 mm tief  
 Streuwert 1.74, horizontal: 1.67, vertikal: 1.81

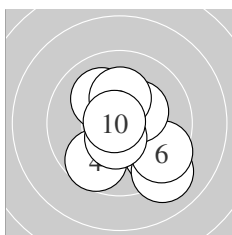
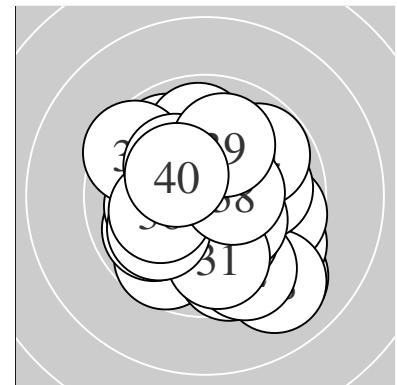

Serie 1:  
 9.6 ↘ 10.5 \* 9.1 ↘ 9.7 ↙ 10.1 ↖  
 9.5 ↘ 10.3 \* 10.2 \* 10.5 \* 10.8 \*  
 beste Teiler 39.8 (10.) 103.1 (2.) 109.6 (9.)  
 Trefferlage 0.73 mm rechts, 0.71 mm tief  
 Streuwert 1.81, horizontal: 1.74, vertikal: 1.87

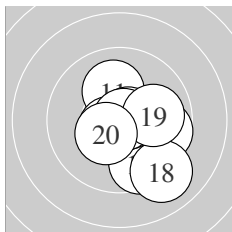

Serie 2:  
 10.1 ↑ 10.2 \* 10.6 \* 9.7 → 9.6 ↓  
 10.7 \* 10.8 \* 9.0 ↘ 10.0 → 10.4 \*  
 beste Teiler 29.2 (17.) 63.7 (16.) 89.4 (13.)  
 Trefferlage 1.00 mm rechts, 0.76 mm tief  
 Streuwert 1.59, horizontal: 1.50, vertikal: 1.67

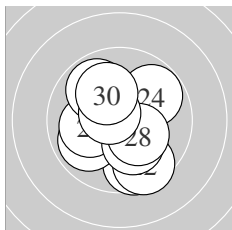

Serie 3:  
 9.6 ↓ 9.5 ↓ 9.9 ↙ 9.8 ↗ 10.1 ←  
 9.9 ↘ 10.2 \* 10.3 \* 10.6 \* 10.1 ↖  
 beste Teiler 87.6 (29.) 168.8 (28.) 195.2 (27.)  
 Trefferlage 0.02 mm links, 0.45 mm tief  
 Streuwert 1.85, horizontal: 1.69, vertikal: 1.99

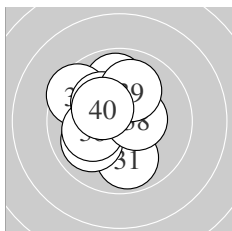

Serie 4:  
 9.9 ↓ 10.6 \* 9.9 ↑ 9.5 ↘ 10.0 ↙  
 10.1 ← 10.2 \* 10.5 \* 10.0 ↑ 10.3 \*  
 beste Teiler 76.4 (32.) 121.6 (38.) 153.0 (40.)  
 Trefferlage 0.71 mm links, 0.51 mm hoch  
 Streuwert 1.54, horizontal: 1.40, vertikal: 1.68

Unterschrift des Schuetzen

Ergebnis: **401.5** (383)  
 Serien: 98.8 100.9 100.1 101.7  
 Zaehler: 23 17 0 0 0 0 0 0 0 0  
 Innenzehner: 17  
 weiteste: 452 (6), 432 (36), 428 (3)  
 beste Teiler 67.9 (32.) 76.4 (28.) 81.0 (33.)  
 Trefferlage 0.24 mm rechts, 0.62 mm tief  
 Streuwert 1.75, horizontal: 2.21, vertikal: 1.11

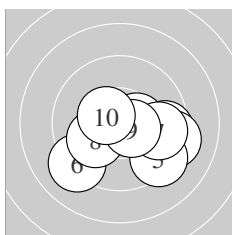
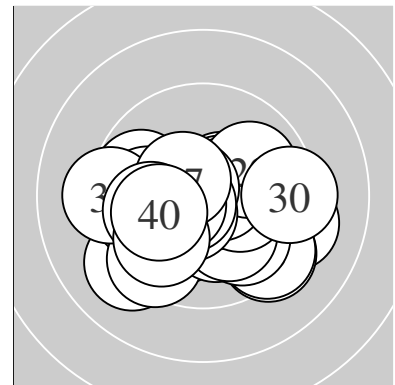

Serie 1:  
 9.5 → 10.5 \* 9.2 → 10.4 \* 9.3 ↘  
 9.1 ↙ 9.7 → 10.1 ↙ 10.5 \* 10.5 \*  
 beste Teiler 103.4 (9.) 105.0 (2.) 119.5 (10.)  
 Trefferlage 1.07 mm rechts, 0.91 mm tief  
 Streuwert 1.94, horizontal: 2.48, vertikal: 1.19

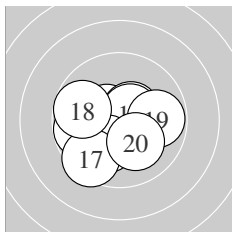

Serie 2:  
 10.5 \* 10.5 \* 10.2 \* 10.6 \* 9.8 ←  
 10.1 ↙ 9.5 ↙ 9.8 ← 9.8 → 10.1 ↘  
 beste Teiler 99.8 (14.) 113.6 (11.) 114.9 (12.)  
 Trefferlage 0.25 mm links, 0.47 mm tief  
 Streuwert 1.70, horizontal: 2.03, vertikal: 1.30

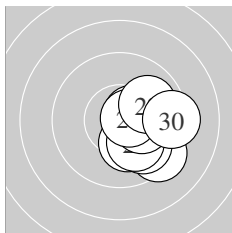

Serie 3:  
 10.5 \* 9.9 → 9.4 ↘ 9.9 ↘ 10.2 \*  
 10.1 ↘ 10.2 \* 10.6 \* 10.0 → 9.3 →  
 beste Teiler 76.4 (28.) 108.2 (21.) 176.7 (27.)  
 Trefferlage 1.87 mm rechts, 0.74 mm tief  
 Streuwert 1.16, horizontal: 1.07, vertikal: 1.23

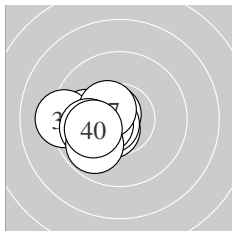

Serie 4:  
 10.5 \* 10.7 \* 10.6 \* 10.5 \* 9.9 ←  
 9.2 ← 10.5 \* 9.9 ← 9.8 ↙ 10.1 ←  
 beste Teiler 67.9 (32.) 81.0 (33.) 103.8 (31.)  
 Trefferlage 1.73 mm links, 0.38 mm tief  
 Streuwert 0.99, horizontal: 1.18, vertikal: 0.76

Unterschrift des Schuetzen

Ergebnis: **414.4** (393)  
 Serien: 103.7 104.2 102.4 104.1  
 Zaehler: 33 7 0 0 0 0 0 0 0 0  
 Innenzehner: 28  
 weiteste: 336 (37), 312 (28), 297 (3)  
 beste Teiler 21.0 (7.) 38.6 (22.) 43.4 (14.)  
 Trefferlage 0.13 mm links, 0.00 mm  
 Streuwert 1.24, horizontal: 1.30, vertikal: 1.17

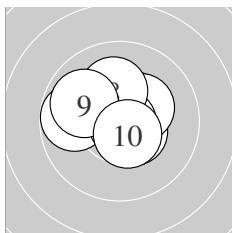
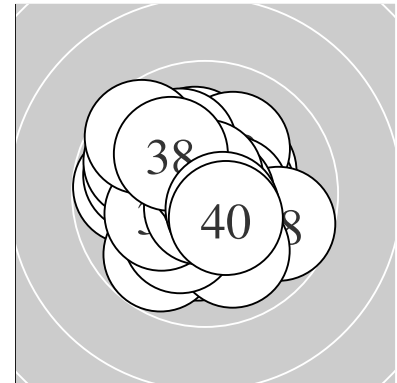

Serie 1:  
 10.6 \*                      10.6 \*                      9.8 ←                      10.5 \*                      10.4 \*  
 10.3 \*                      10.9 \*                      10.1 ↑                      9.9 ↖                      10.6 \*  
 beste Teiler 21.0 (7.) 82.2 (2.) 83.4 (1.)  
 Trefferlage 0.08 mm links, 0.35 mm hoch  
 Streuwert 1.21, horizontal: 1.43, vertikal: 0.94

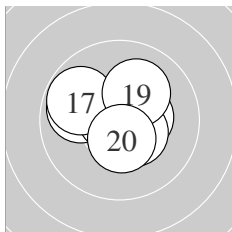

Serie 2:  
 10.8 \*                      10.4 \*                      9.9 ↖                      10.8 \*                      10.7 \*  
 10.7 \*                      9.8 ↖                      10.5 \*                      10.1 ↗                      10.5 \*  
 beste Teiler 43.4 (14.) 48.0 (11.) 57.0 (15.)  
 Trefferlage 0.14 mm links, 0.28 mm hoch  
 Streuwert 1.17, horizontal: 1.39, vertikal: 0.89

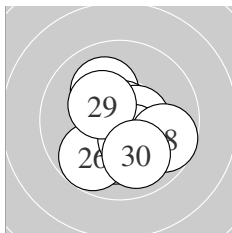

Serie 3:  
 10.1 ↖                      10.8 \*                      10.2 \*                      10.6 \*                      10.5 \*  
 9.8 ↙                      10.4 \*                      9.7 ↘                      10.3 \*                      10.0 ↘  
 beste Teiler 38.6 (22.) 98.7 (24.) 105.0 (25.)  
 Trefferlage 0.19 mm rechts, 0.66 mm tief  
 Streuwert 1.40, horizontal: 1.35, vertikal: 1.44

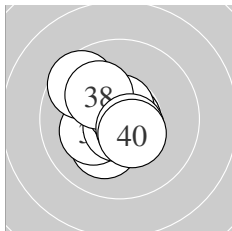

Serie 4:  
 10.7 \*                      10.2 \*                      10.2 \*                      10.7 \*                      10.8 \*  
 10.7 \*                      9.6 ↖                      10.1 ↖                      10.6 \*                      10.5 \*  
 beste Teiler 49.0 (35.) 54.0 (31.) 56.3 (34.)  
 Trefferlage 0.51 mm links, 0.01 mm hoch  
 Streuwert 1.15, horizontal: 1.11, vertikal: 1.20

Unterschrift des Schuetzen

Meyton Elektronik



Ergebnis: **359.9** (344)  
 Serien: 86.6 90.9 91.4 91.0  
 Zaehler: 5 21 9 3 2 0 0 0 0 0  
 Innenzehner: 3  
 weiteste: 1213 (20), 1134 (4), 967 (8)  
 beste Teiler 96.0 (11.) 174.1 (39.) 178.1 (25.)  
 Trefferlage 0.12 mm links, 0.94 mm tief  
 Streuwert 3.89, horizontal: 3.99, vertikal: 3.79

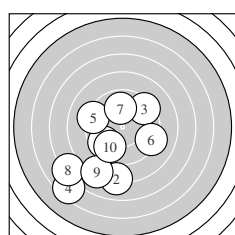
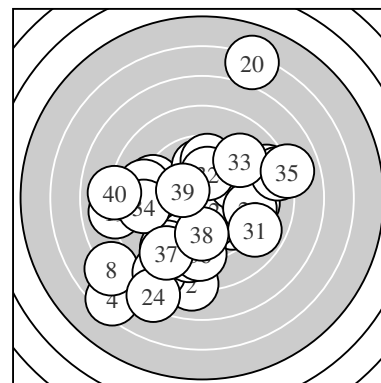

Serie 1:  
 9.6 ↙ 8.0 ↓ 9.4 ↗ 6.4 ↙ 9.2 ↖  
 9.2 ↘ 9.9 ↑ 7.1 ↙ 8.1 ↙ 9.7 ↙  
 beste Teiler 266.6 (7.) 322.5 (10.) 336.5 (1.)  
 Trefferlage 2.14 mm links, 2.78 mm tief  
 Streuwert 3.99, horizontal: 3.88, vertikal: 4.10

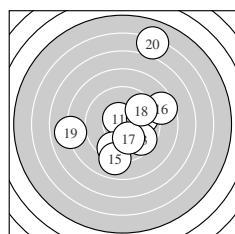

Serie 2:  
 10.6 \* 9.8 → 9.6 ↘ 9.5 ↓ 9.0 ↓  
 8.6 → 10.1 ↓ 9.6 ↗ 8.0 ← 6.1 ↑  
 beste Teiler 96.0 (11.) 211.0 (17.) 292.5 (12.)  
 Trefferlage 0.81 mm rechts, 0.39 mm hoch  
 Streuwert 4.09, horizontal: 3.63, vertikal: 4.50

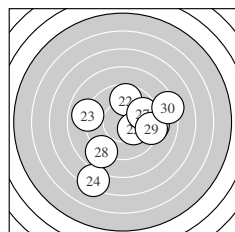

Serie 3:  
 9.8 → 9.7 ↑ 9.0 ← 7.3 ↓ 10.2 \*  
 9.2 → 9.7 → 8.9 ↙ 9.3 → 8.3 →  
 beste Teiler 178.1 (25.) 285.0 (21.) 306.0 (27.)  
 Trefferlage 1.02 mm rechts, 0.66 mm tief  
 Streuwert 3.57, horizontal: 3.83, vertikal: 3.30

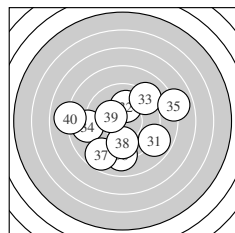

Serie 4:  
 8.9 ↘ 10.1 ↑ 9.2 ↗ 9.0 ← 7.9 →  
 9.1 ↓ 8.8 ↙ 9.7 ↓ 10.3 \* 8.0 ←  
 beste Teiler 174.1 (39.) 209.8 (32.) 302.0 (38.)  
 Trefferlage 0.18 mm links, 0.72 mm tief  
 Streuwert 3.70, horizontal: 4.36, vertikal: 2.89

Unterschrift des Schuetzen

Meyton Elektronik

Ergebnis: **389.0** (372)  
 Serien: 97.8 94.1 101.1 96.0  
 Zaehler: 17 18 5 0 0 0 0 0 0 0  
 Innenzehner: 12  
 weiteste: 647 (37), 637 (5), 531 (11)  
 beste Teiler 45.0 (2.) 68.1 (30.) 101.8 (8.)  
 Trefferlage 1.44 mm links, 0.42 mm tief  
 Streuwert 2.21, horizontal: 2.64, vertikal: 1.65

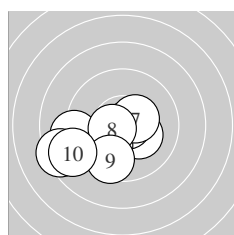
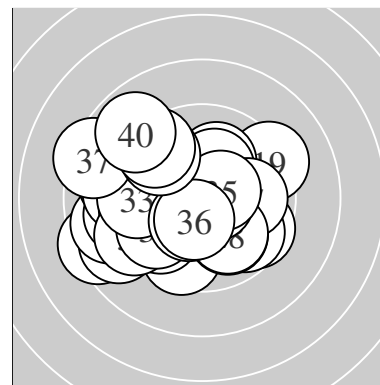

Serie 1:  
 10.2 \*                      10.8 \*                      10.0 ✓                      9.1 ←                      8.4 ←  
 10.0 ✓                      10.4 \*                      10.5 \*                      9.6 ↓                      8.8 ←  
 beste Teiler 45.0 (2.) 101.8 (8.) 131.9 (7.)  
 Trefferlage 1.67 mm links, 1.35 mm tief  
 Streuwert 2.00, horizontal: 2.54, vertikal: 1.25

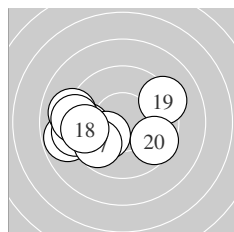

Serie 2:  
 8.8 ←                      9.6 ←                      10.2 \*                      9.2 ←                      9.0 ←  
 9.2 ←                      9.7 ✓                      9.5 ←                      9.3 →                      9.6 →  
 beste Teiler 196.1 (13.) 305.6 (17.) 340.9 (12.)  
 Trefferlage 2.27 mm links, 0.51 mm tief  
 Streuwert 2.41, horizontal: 3.16, vertikal: 1.26

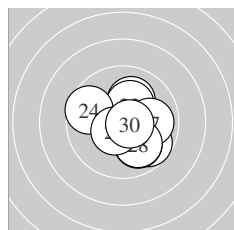

Serie 3:  
 10.1 ↑                      10.4 \*                      10.2 \*                      9.6 ↖                      9.7 ↘  
 10.0 ↘                      9.9 →                      10.0 ↘                      10.5 \*                      10.7 \*  
 beste Teiler 68.1 (30.) 109.1 (29.) 134.3 (22.)  
 Trefferlage 0.67 mm rechts, 0.33 mm tief  
 Streuwert 1.57, horizontal: 1.63, vertikal: 1.52

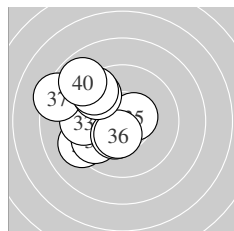

Serie 4:  
 9.2 ←                      9.7 ✓                      9.5 ←                      10.4 \*                      10.5 \*  
 10.4 \*                      8.4 ↖                      9.6 ↘                      9.4 ↘                      8.9 ↘  
 beste Teiler 111.4 (35.) 129.6 (36.) 148.7 (34.)  
 Trefferlage 2.49 mm links, 0.51 mm hoch  
 Streuwert 2.07, horizontal: 2.03, vertikal: 2.11

Unterschrift des Schuetzen

Meyton Elektronik

Ergebnis: **419.4** (398)  
 Serien: 105.3 104.3 105.4 104.4  
 Zaehler: 38 2 0 0 0 0 0 0 0 0  
 Innenzehner: 35  
 weiteste: 290 (12), 270 (3), 232 (21)  
 beste Teiler 8.9 (23.) 21.3 (15.) 34.2 (19.)  
 Trefferlage 0.01 mm rechts, 0.03 mm hoch  
 Streuwert 0.97, horizontal: 1.15, vertikal: 0.74

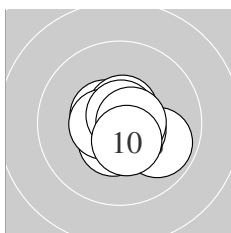
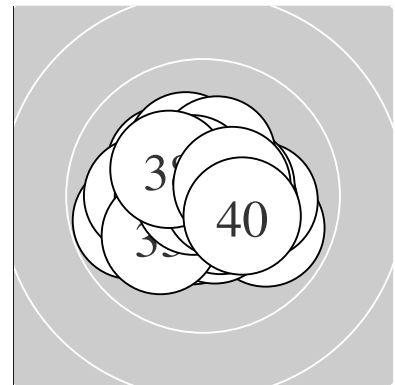

Serie 1:  
 10.5 \*                      10.7 \*                      9.9 ↘                      10.6 \*                      10.5 \*  
 10.6 \*                      10.6 \*                      10.7 \*                      10.7 \*                      10.5 \*  
 beste Teiler 51.9 (8.) 54.3 (2.) 73.2 (9.)  
 Trefferlage 0.17 mm rechts, 0.19 mm tief  
 Streuwert 0.89, horizontal: 1.00, vertikal: 0.75

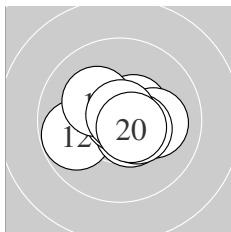

Serie 2:  
 10.4 \*                      9.8 ←                      10.5 \*                      10.5 \*                      10.9 \*  
 10.1 →                      10.5 \*                      10.2 \*                      10.8 \*                      10.6 \*  
 beste Teiler 21.3 (15.) 34.2 (19.) 87.9 (20.)  
 Trefferlage 0.03 mm rechts, 0.01 mm hoch  
 Streuwert 1.13, horizontal: 1.43, vertikal: 0.70

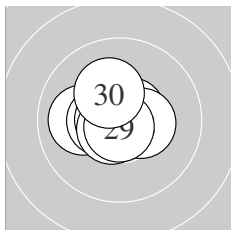

Serie 3:  
 10.0 ←                      10.6 \*                      10.9 \*                      10.5 \*                      10.7 \*  
 10.7 \*                      10.6 \*                      10.4 \*                      10.8 \*                      10.2 \*  
 beste Teiler 8.9 (23.) 43.1 (29.) 63.0 (25.)  
 Trefferlage 0.41 mm links, 0.15 mm hoch  
 Streuwert 0.84, horizontal: 1.00, vertikal: 0.65

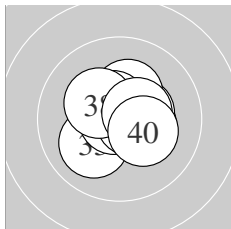

Serie 4:  
 10.4 \*                      10.4 \*                      10.1 ↙                      10.3 \*                      10.6 \*  
 10.8 \*                      10.7 \*                      10.3 \*                      10.5 \*                      10.3 \*  
 beste Teiler 36.0 (36.) 74.8 (37.) 95.2 (35.)  
 Trefferlage 0.28 mm rechts, 0.14 mm hoch  
 Streuwert 1.03, horizontal: 1.14, vertikal: 0.91

Unterschrift des Schuetzen

Meyton Elektronik

Ergebnis: **414.6** (395)  
 Serien: 102.4 103.3 105.9 103.0  
 Zaehler: 35 5 0 0 0 0 0 0 0 0  
 Innenzehner: 31  
 weiteste: 315 (4), 315 (31), 291 (2)  
 beste Teiler 44.3 (17.) 46.1 (20.) 60.5 (25.)  
 Trefferlage 0.31 mm rechts, 0.12 mm hoch  
 Streuwert 1.17, horizontal: 1.34, vertikal: 0.96

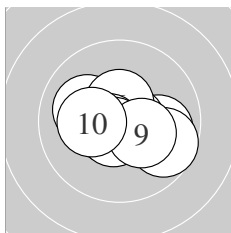
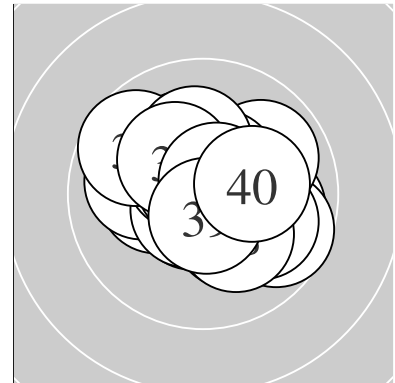

Serie 1:  
 10.1 ↖ 9.8 ↗ 9.9 → 9.7 ↘ 10.7 \*  
 10.5 \* 10.6 \* 10.6 \* 10.3 \* 10.2 \*  
 beste Teiler 71.0 (5.) 80.1 (8.) 85.4 (7.)  
 Trefferlage 0.51 mm rechts, 0.31 mm tief  
 Streuwert 1.40, horizontal: 1.82, vertikal: 0.78

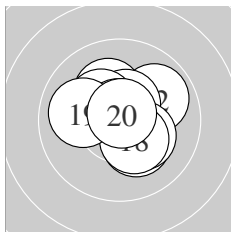

Serie 2:  
 10.2 \* 9.9 ↗ 10.5 \* 10.3 \* 10.2 \*  
 10.3 \* 10.8 \* 10.3 \* 10.0 ← 10.8 \*  
 beste Teiler 44.3 (17.) 46.1 (20.) 111.4 (13.)  
 Trefferlage 0.18 mm rechts, 0.29 mm hoch  
 Streuwert 1.25, horizontal: 1.35, vertikal: 1.13

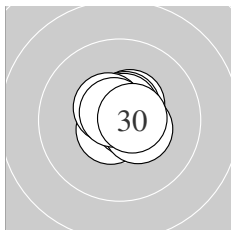

Serie 3:  
 10.5 \* 10.7 \* 10.6 \* 10.6 \* 10.7 \*  
 10.4 \* 10.6 \* 10.5 \* 10.7 \* 10.6 \*  
 beste Teiler 60.5 (25.) 61.6 (29.) 64.1 (22.)  
 Trefferlage 0.17 mm rechts, 0.31 mm hoch  
 Streuwert 0.64, horizontal: 0.68, vertikal: 0.59

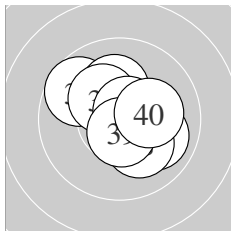

Serie 4:  
 9.7 ↖ 10.6 \* 10.6 \* 10.2 \* 10.3 \*  
 10.0 ↗ 10.7 \* 10.1 ↘ 10.6 \* 10.2 \*  
 beste Teiler 73.5 (37.) 85.9 (39.) 88.2 (32.)  
 Trefferlage 0.37 mm rechts, 0.21 mm hoch  
 Streuwert 1.33, horizontal: 1.44, vertikal: 1.21

Unterschrift des Schuetzen

Meyton Elektronik

Ergebnis: **416.5** (398)  
 Serien: 103.1 104.1 104.0 105.3  
 Zaehler: 38 2 0 0 0 0 0 0 0 0  
 Innenzehner: 35  
 weiteste: 268 (1), 259 (4), 232 (24)  
 beste Teiler 5.3 (5.) 41.0 (19.) 46.1 (37.)  
 Trefferlage 0.00 mm , 0.11 mm tief  
 Streuwert 1.04, horizontal: 0.99, vertikal: 1.10

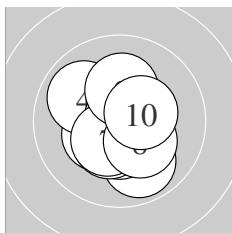
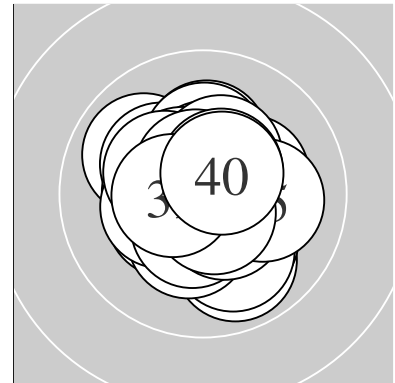

Serie 1:  
 9.9 ↘ 10.3 \* 10.4 \* 9.9 ↘ 10.9 \*  
 10.4 \* 10.4 \* 10.3 \* 10.2 \* 10.4 \*  
 beste Teiler 5.3 (5.) 129.0 (3.) 132.0 (7.)  
 Trefferlage 0.09 mm links, 0.42 mm tief  
 Streuwert 1.25, horizontal: 1.15, vertikal: 1.35

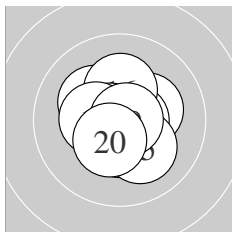

Serie 2:  
 10.2 \* 10.6 \* 10.5 \* 10.2 \* 10.1 ↘  
 10.2 \* 10.7 \* 10.4 \* 10.8 \* 10.4 \*  
 beste Teiler 41.0 (19.) 59.0 (17.) 77.0 (12.)  
 Trefferlage 0.00 mm , 0.04 mm tief  
 Streuwert 1.07, horizontal: 1.06, vertikal: 1.08

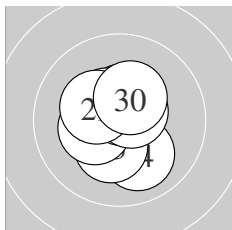

Serie 3:  
 10.4 \* 10.5 \* 10.5 \* 10.0 ↘ 10.3 \*  
 10.3 \* 10.7 \* 10.6 \* 10.3 \* 10.4 \*  
 beste Teiler 71.5 (27.) 89.2 (28.) 116.5 (22.)  
 Trefferlage 0.21 mm links, 0.02 mm hoch  
 Streuwert 1.08, horizontal: 0.90, vertikal: 1.23

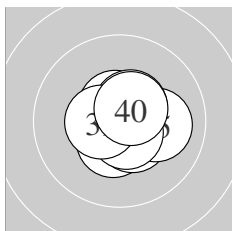

Serie 4:  
 10.7 \* 10.6 \* 10.5 \* 10.5 \* 10.1 →  
 10.5 \* 10.8 \* 10.6 \* 10.5 \* 10.5 \*  
 beste Teiler 46.1 (37.) 61.4 (31.) 80.2 (38.)  
 Trefferlage 0.28 mm rechts, 0.02 mm tief  
 Streuwert 0.83, horizontal: 0.91, vertikal: 0.75

Unterschrift des Schuetzen

Meyton Elektronik

Ergebnis: **415.0** (395)  
 Serien: 104.2 103.3 102.9 104.6  
 Zaehler: 35 5 0 0 0 0 0 0 0 0  
 Innenzehner: 32  
 weiteste: 338 (14), 286 (30), 267 (3)  
 beste Teiler 60.0 (17.) 61.0 (4.) 61.0 (39.)  
 Trefferlage 0.52 mm links, 0.01 mm hoch  
 Streuwert 1.09, horizontal: 1.02, vertikal: 1.16

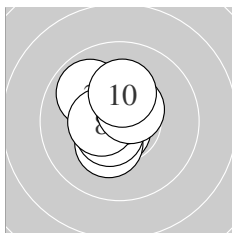
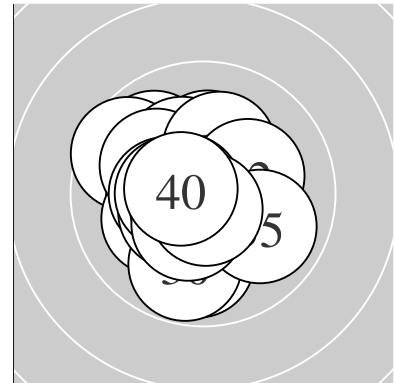

Serie 1:  
 10.1 ↖ 10.7 \* 9.9 ↖ 10.7 \* 10.3 \*  
 10.6 \* 10.7 \* 10.5 \* 10.5 \* 10.2 \*  
 beste Teiler 61.0 (4.) 65.6 (2.) 71.5 (7.)  
 Trefferlage 0.57 mm links, 0.32 mm hoch  
 Streuwert 1.00, horizontal: 0.82, vertikal: 1.15

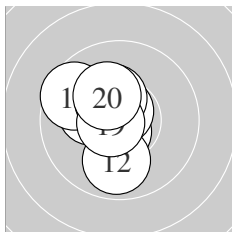

Serie 2:  
 10.6 \* 9.9 ↓ 10.2 \* 9.6 ↖ 10.4 \*  
 10.6 \* 10.7 \* 10.4 \* 10.7 \* 10.2 \*  
 beste Teiler 60.0 (17.) 61.4 (19.) 76.2 (11.)  
 Trefferlage 0.83 mm links, 0.42 mm hoch  
 Streuwert 1.14, horizontal: 0.91, vertikal: 1.33

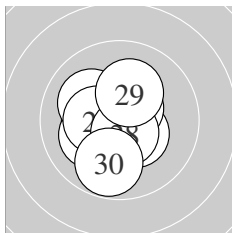

Serie 3:  
 10.3 \* 10.1 ↙ 10.4 \* 10.1 ↖ 10.5 \*  
 10.5 \* 10.4 \* 10.6 \* 10.2 \* 9.8 ↓  
 beste Teiler 88.7 (28.) 102.9 (25.) 110.3 (26.)  
 Trefferlage 0.55 mm links, 0.27 mm tief  
 Streuwert 1.22, horizontal: 1.13, vertikal: 1.30

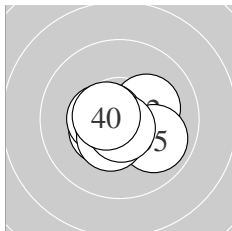

Serie 4:  
 10.6 \* 10.2 \* 10.4 \* 10.5 \* 9.9 ↘  
 10.6 \* 10.4 \* 10.7 \* 10.7 \* 10.6 \*  
 beste Teiler 61.0 (39.) 72.0 (38.) 85.7 (36.)  
 Trefferlage 0.14 mm links, 0.42 mm tief  
 Streuwert 0.97, horizontal: 1.20, vertikal: 0.66

Unterschrift des Schuetzen

Ergebnis: **417.4** (399)  
 Serien: 103.6 104.8 104.4 104.6  
 Zaehler: 39 1 0 0 0 0 0 0 0 0  
 Innenzehner: 34  
 weiteste: 290 (8), 228 (16), 223 (4)  
 beste Teiler 10.7 (38.) 35.5 (14.) 38.8 (39.)  
 Trefferlage 0.16 mm links, 0.00 mm  
 Streuwert 1.02, horizontal: 1.17, vertikal: 0.84

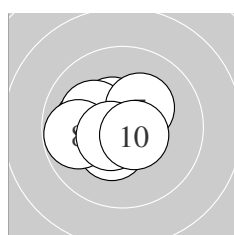
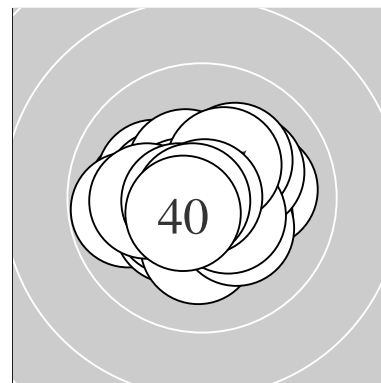

Serie 1:  
 10.6 \*                      10.4 \*                      10.6 \*                      10.1 ←                      10.5 \*  
 10.1 ↖                      10.3 \*                      9.8 ←                      10.6 \*                      10.6 \*  
 beste Teiler 84.0 (1.) 88.5 (3.) 90.6 (10.)  
 Trefferlage 0.77 mm links, 0.20 mm hoch  
 Streuwert 1.07, horizontal: 1.26, vertikal: 0.84

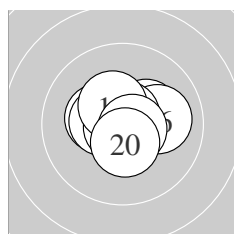

Serie 2:  
 10.6 \*                      10.3 \*                      10.5 \*                      10.8 \*                      10.3 \*  
 10.0 →                      10.7 \*                      10.4 \*                      10.7 \*                      10.5 \*  
 beste Teiler 35.5 (14.) 57.5 (17.) 70.2 (19.)  
 Trefferlage 0.03 mm rechts, 0.20 mm hoch  
 Streuwert 0.96, horizontal: 1.19, vertikal: 0.65

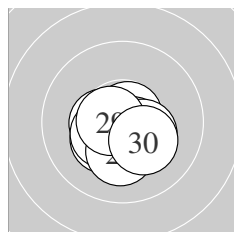

Serie 3:  
 10.4 \*                      10.5 \*                      10.3 \*                      10.4 \*                      10.8 \*  
 10.6 \*                      10.4 \*                      10.2 \*                      10.6 \*                      10.2 \*  
 beste Teiler 50.9 (25.) 77.4 (29.) 84.8 (26.)  
 Trefferlage 0.08 mm links, 0.73 mm tief  
 Streuwert 0.86, horizontal: 0.99, vertikal: 0.71

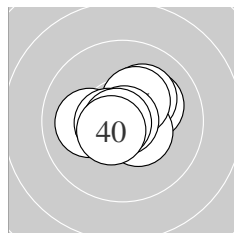

Serie 4:  
 10.1 ↗                      10.5 \*                      10.2 \*                      10.5 \*                      10.3 \*  
 10.1 ←                      10.6 \*                      10.9 \*                      10.8 \*                      10.6 \*  
 beste Teiler 10.7 (38.) 38.8 (39.) 90.7 (37.)  
 Trefferlage 0.15 mm rechts, 0.30 mm hoch  
 Streuwert 1.01, horizontal: 1.19, vertikal: 0.79

Unterschrift des Schuetzen

Meyton Elektronik