

Ergebnis: **307.4** (295)
 Serien: 103.0 101.9 102.5
 Zähler: 25 5 0 0 0 0 0 0 0 0
 Innenzehner: 20
 weiteste: 387 (29), 352 (15), 342 (18)
 beste Teiler 53.1 (9.) 59.2 (12.) 67.9 (17.)
 Trefferlage 0.10 mm rechts, 0.49 mm hoch
 Streuwert 1.37, horizontal: 1.39, vertikal: 1.36

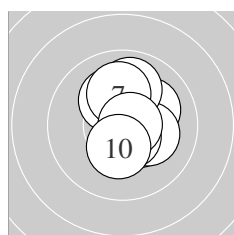

Serie 1:
 10.1 ↗ 10.5 * 10.4 * 10.2 * 10.2 *
 9.9 ↑ 10.1 ↑ 10.6 * 10.7 * 10.3 *
 beste Teiler 53.1 (9.) 90.9 (8.) 107.2 (2.)
 Trefferlage 0.48 mm rechts, 0.49 mm hoch
 Streuwert 1.16, horizontal: 0.87, vertikal: 1.40

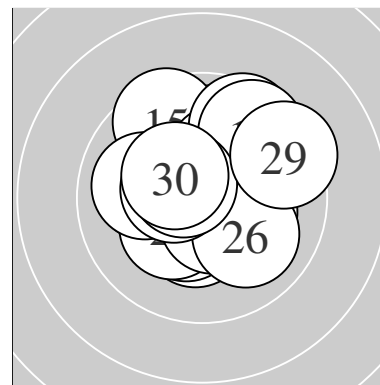
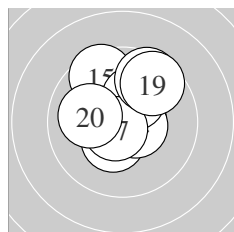

Serie 2:
 10.4 * 10.7 * 10.6 * 10.6 * 9.5 ↘
 10.2 * 10.7 * 9.6 ↗ 9.6 ↗ 10.0 ←
 beste Teiler 59.2 (12.) 67.9 (17.) 84.8 (13.)
 Trefferlage 0.19 mm rechts, 0.92 mm hoch
 Streuwert 1.49, horizontal: 1.39, vertikal: 1.59

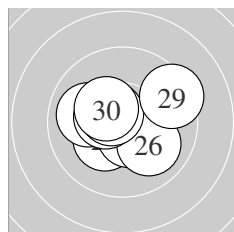

Serie 3:
 10.4 * 10.3 * 10.4 * 10.5 * 10.0 ←
 10.0 ↘ 10.5 * 10.6 * 9.4 ↗ 10.4 *
 beste Teiler 97.8 (28.) 103.7 (24.) 123.6 (27.)
 Trefferlage 0.36 mm links, 0.07 mm hoch
 Streuwert 1.44, horizontal: 1.76, vertikal: 1.03

Unterschrift des Schützen

Meyton Elektronik

Ergebnis: **306.2** (294)
 Serien: 101.0 101.9 103.3
 Zähler: 24 6 0 0 0 0 0 0 0 0
 Innenzehner: 19
 weiteste: 375 (7), 356 (1), 338 (18)
 beste Teiler 64.5 (25.) 76.4 (20.) 88.3 (19.)
 Trefferlage 0.02 mm links, 0.25 mm hoch
 Streuwert 1.45, horizontal: 1.68, vertikal: 1.18

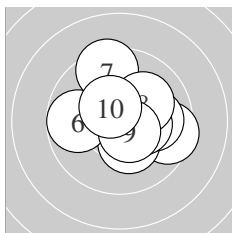
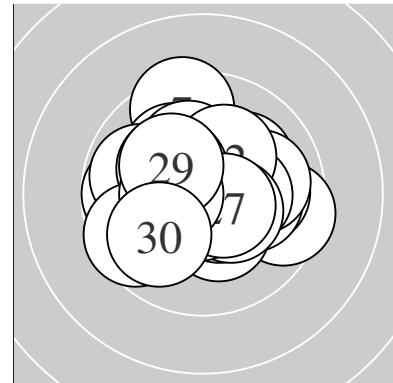

Serie 1:
 9.5 → 10.3 * 10.0 → 10.4 * 10.3 *
 9.8 ← 9.5 ↑ 10.1 ↗ 10.6 * 10.5 *
 beste Teiler 100.4 (9.) 122.8 (10.) 145.3 (4.)
 Trefferlage 0.66 mm rechts, 0.39 mm hoch
 Streuwert 1.66, horizontal: 1.83, vertikal: 1.47

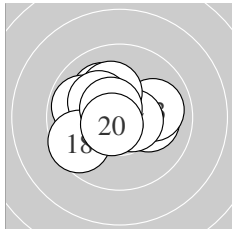

Serie 2:
 10.1 ↖ 10.1 → 10.0 → 9.9 ← 10.6 *
 10.2 * 10.2 * 9.6 ↙ 10.6 * 10.6 *
 beste Teiler 76.4 (20.) 88.3 (19.) 92.1 (15.)
 Trefferlage 0.47 mm links, 0.36 mm hoch
 Streuwert 1.48, horizontal: 1.79, vertikal: 1.08

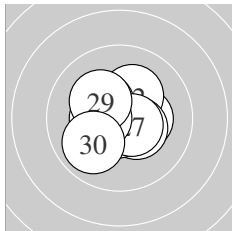

Serie 3:
 10.3 * 10.2 * 10.4 * 10.4 * 10.7 *
 10.3 * 10.5 * 10.4 * 10.2 * 9.9 ↙
 beste Teiler 64.5 (25.) 101.2 (27.) 132.0 (24.)
 Trefferlage 0.26 mm links, 0.00 mm
 Streuwert 1.17, horizontal: 1.31, vertikal: 1.02

Unterschrift des Schützen

Ergebnis: **308.2** (294)
 Serien: 103.0 102.8 102.4
 Zähler: 24 6 0 0 0 0 0 0 0 0
 Innenzehner: 20
 weiteste: 361 (23), 330 (11), 308 (15)
 beste Teiler 58.3 (27.) 72.2 (20.) 72.9 (26.)
 Trefferlage 0.74 mm links, 0.25 mm hoch
 Streuwert 1.23, horizontal: 1.33, vertikal: 1.13

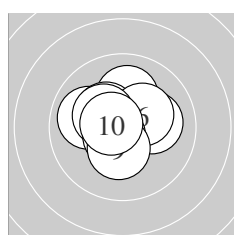
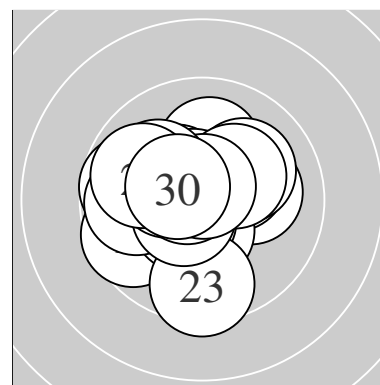

Serie 1:
 10.5 * 10.1 ↑ 9.9 ← 10.1 → 10.3 *
 10.3 * 10.3 * 10.6 * 10.3 * 10.6 *
 beste Teiler 84.7 (10.) 87.7 (8.) 120.3 (1.)
 Trefferlage 0.27 mm links, 0.52 mm hoch
 Streuwert 1.18, horizontal: 1.32, vertikal: 1.01

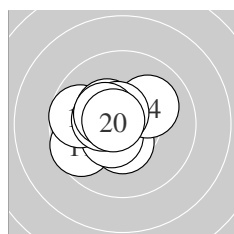

Serie 2:
 9.6 ← 10.4 * 10.5 * 10.1 ↗ 9.7 ←
 10.4 * 10.6 * 10.4 * 10.4 * 10.7 *
 beste Teiler 72.2 (20.) 88.1 (17.) 116.1 (13.)
 Trefferlage 0.98 mm links, 0.12 mm hoch
 Streuwert 1.21, horizontal: 1.39, vertikal: 0.99

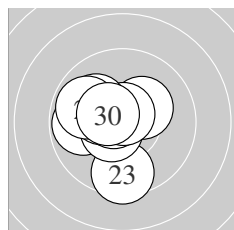

Serie 3:
 9.8 ← 10.3 * 9.5 ↓ 10.6 * 10.3 *
 10.7 * 10.7 * 10.1 ↘ 9.9 ← 10.5 *
 beste Teiler 58.3 (27.) 72.9 (26.) 97.8 (24.)
 Trefferlage 0.97 mm links, 0.10 mm hoch
 Streuwert 1.35, horizontal: 1.27, vertikal: 1.41

Unterschrift des Schützen

Ergebnis: **304.4** (293)
 Serien: 101.2 101.8 101.4
 Zähler: 23 7 0 0 0 0 0 0 0 0
 Innenzehner: 17
 weiteste: 443 (2), 302 (24), 294 (8)
 beste Teiler 53.9 (15.) 99.3 (27.) 104.4 (3.)
 Trefferlage 0.23 mm links, 0.69 mm tief
 Streuwert 1.46, horizontal: 1.60, vertikal: 1.29

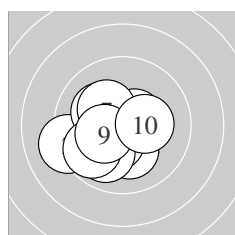
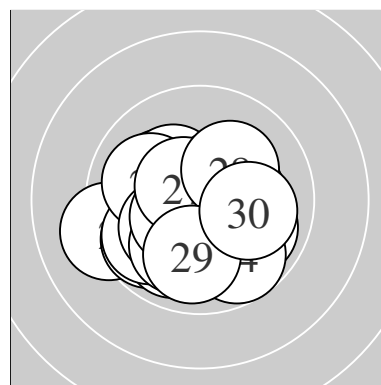

Serie 1:
 10.2 * 9.2 ← 10.5 * 10.4 * 10.0 ↘
 10.2 * 10.3 * 9.8 ↙ 10.3 * 10.3 *
 beste Teiler 104.4 (3.) 135.6 (4.) 154.7 (9.)
 Trefferlage 0.95 mm links, 0.63 mm tief
 Streuwert 1.50, horizontal: 1.70, vertikal: 1.26

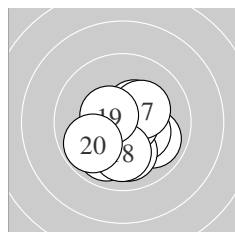

Serie 2:
 9.9 ↘ 10.4 * 10.3 * 10.0 ↓ 10.7 *
 9.9 ↙ 10.3 * 10.0 ↓ 10.5 * 9.8 ↙
 beste Teiler 53.9 (15.) 115.3 (19.) 132.4 (12.)
 Trefferlage 0.23 mm rechts, 0.81 mm tief
 Streuwert 1.37, horizontal: 1.40, vertikal: 1.33

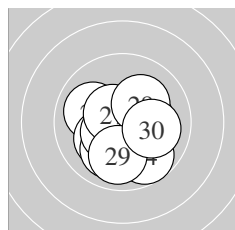

Serie 3:
 10.0 ↖ 10.2 * 10.0 ↙ 9.7 ↘ 10.5 *
 10.3 * 10.6 * 10.2 * 9.9 ↓ 10.0 →
 beste Teiler 99.3 (27.) 125.4 (25.) 170.1 (26.)
 Trefferlage 0.00 mm , 0.65 mm tief
 Streuwert 1.50, horizontal: 1.59, vertikal: 1.42

Unterschrift des Schützen

Meyton Elektronik

Ergebnis: **298.3** (285)
 Serien: 100.6 98.2 99.5
 Zähler: 19 8 2 1 0 0 0 0 0 0
 Innenzehner: 15
 weiteste: 848 (25), 669 (3), 558 (18)
 beste Teiler 14.0 (4.) 15.5 (29.) 55.4 (15.)
 Trefferlage 1.17 mm links, 0.52 mm tief
 Streuwert 2.09, horizontal: 2.70, vertikal: 1.21

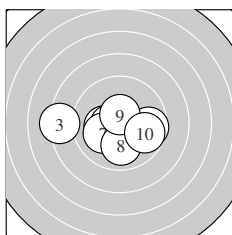
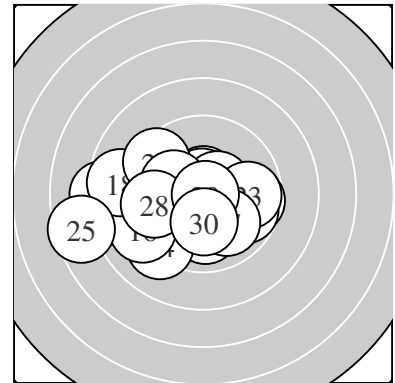

Serie 1:
 10.3 * 9.6 → 8.3 ← 10.9 * 10.5 *
 10.5 * 10.1 ↙ 10.0 ↓ 10.6 * 9.8 →
 beste Teiler 14.0 (4.) 95.0 (9.) 103.7 (5.)
 Trefferlage 0.57 mm links, 0.53 mm tief
 Streuwert 2.04, horizontal: 2.75, vertikal: 0.89

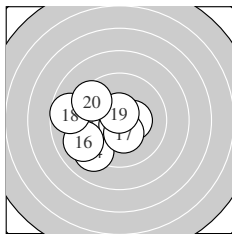

Serie 2:
 10.3 * 9.4 ← 10.4 * 9.2 ↘ 10.7 *
 9.1 ↙ 10.4 * 8.7 ← 10.6 * 9.4 ↖
 beste Teiler 55.4 (15.) 79.4 (19.) 141.0 (13.)
 Trefferlage 1.90 mm links, 0.45 mm tief
 Streuwert 2.00, horizontal: 2.30, vertikal: 1.65

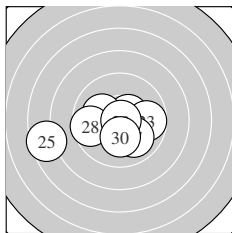

Serie 3:
 10.5 * 10.5 * 9.8 → 10.3 * 7.6 ←
 10.1 ↖ 10.0 ↘ 9.6 ← 10.9 * 10.2 *
 beste Teiler 15.5 (29.) 113.7 (21.) 122.2 (22.)
 Trefferlage 1.04 mm links, 0.57 mm tief
 Streuwert 2.32, horizontal: 3.10, vertikal: 1.09

Unterschrift des Schützen

Ergebnis: **305.4** (290)
 Serien: 102.7 101.7 101.0
 Zähler: 20 10 0 0 0 0 0 0 0 0
 Innenzehner: 14
 weiteste: 315 (23), 298 (25), 285 (17)
 beste Teiler 27.1 (6.) 48.0 (27.) 56.3 (9.)
 Trefferlage 0.13 mm rechts, 0.14 mm hoch
 Streuwert 1.50, horizontal: 1.78, vertikal: 1.17

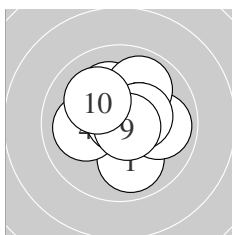
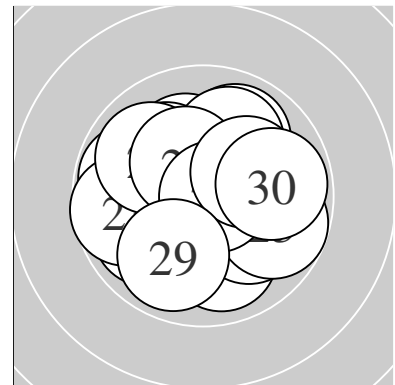

Serie 1:
 10.0 ↘ 10.2 * 10.6 * 10.1 ← 9.9 →
 10.8 * 9.9 ↗ 10.4 * 10.7 * 10.1 ↘
 beste Teiler 27.1 (6.) 56.3 (9.) 92.4 (3.)
 Trefferlage 0.24 mm rechts, 0.40 mm hoch
 Streuwert 1.38, horizontal: 1.42, vertikal: 1.33

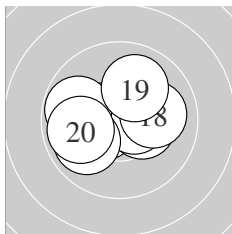

Serie 2:
 10.5 * 10.2 * 10.5 * 10.3 * 10.6 *
 9.9 ↙ 9.8 ← 10.0 → 10.0 ↗ 9.9 ←
 beste Teiler 99.0 (15.) 103.3 (11.) 113.0 (13.)
 Trefferlage 0.21 mm links, 0.11 mm hoch
 Streuwert 1.52, horizontal: 1.92, vertikal: 0.95

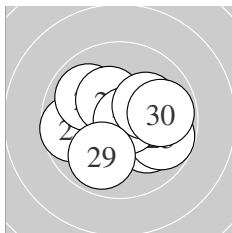

Serie 3:
 10.1 ↘ 10.5 * 9.7 ← 9.9 ↘ 9.8 →
 10.3 * 10.8 * 10.2 * 9.9 ↙ 9.8 →
 beste Teiler 48.0 (27.) 125.3 (22.) 152.0 (26.)
 Trefferlage 0.37 mm rechts, 0.07 mm tief
 Streuwert 1.70, horizontal: 2.05, vertikal: 1.25

Unterschrift des Schützen

Ergebnis: **310.0** (296)
 Serien: 104.6 101.1 104.3
 Zähler: 26 4 0 0 0 0 0 0 0 0
 Innenzehner: 18
 weiteste: 446 (12), 325 (22), 324 (11)
 beste Teiler 21.6 (3.) 21.9 (9.) 27.5 (30.)
 Trefferlage 0.10 mm rechts, 0.14 mm tief
 Streuwert 1.36, horizontal: 1.72, vertikal: 0.85

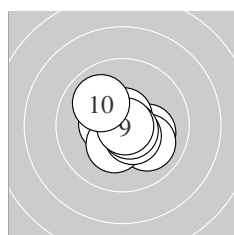
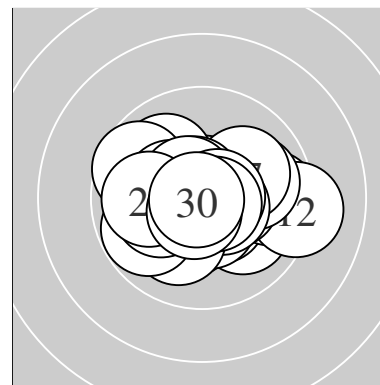

Serie 1:
 10.1 → 10.5 * 10.9 * 10.0 ↘ 10.7 *
 10.3 * 10.5 * 10.7 * 10.9 * 10.0 ↖
 beste Teiler 21.6 (3.) 21.9 (9.) 70.0 (8.)
 Trefferlage 0.17 mm rechts, 0.21 mm tief
 Streuwert 1.09, horizontal: 1.20, vertikal: 0.97

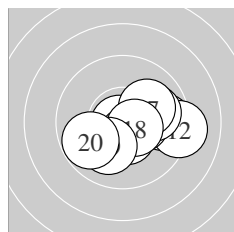

Serie 2:
 9.7 → 9.2 → 10.8 * 10.5 * 10.4 *
 10.0 → 10.1 ↗ 10.5 * 10.1 ↙ 9.8 ↖
 beste Teiler 29.9 (13.) 103.7 (18.) 114.8 (14.)
 Trefferlage 1.07 mm rechts, 0.37 mm tief
 Streuwert 1.60, horizontal: 2.07, vertikal: 0.93

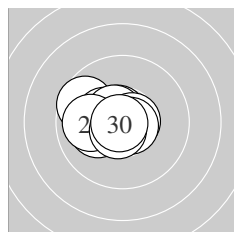

Serie 3:
 10.1 ← 9.7 ↖ 10.3 * 10.7 * 10.6 *
 10.0 ← 10.7 * 10.7 * 10.7 * 10.8 *
 beste Teiler 27.5 (30.) 63.9 (28.) 73.2 (27.)
 Trefferlage 0.92 mm links, 0.16 mm hoch
 Streuwert 0.99, horizontal: 1.25, vertikal: 0.63

Unterschrift des Schützen

Ergebnis: **297.9** (286)
 Serien: 99.2 99.8 98.9
 Zähler: 16 14 0 0 0 0 0 0 0 0
 Innenzehner: 10
 weiteste: 408 (26), 390 (6), 384 (2)
 beste Teiler 103.3 (10.) 105.1 (28.) 138.5 (7.)
 Trefferlage 0.14 mm links, 0.77 mm hoch
 Streuwert 1.86, horizontal: 2.23, vertikal: 1.40

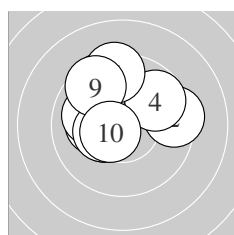
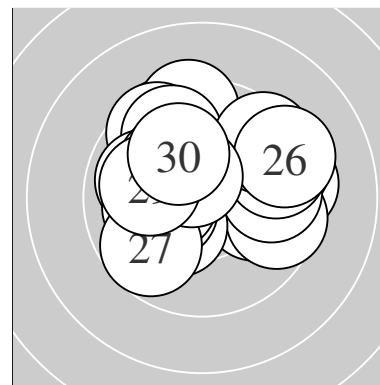

Serie 1:
 9.6 ↘ 9.4 → 10.2 * 9.7 ↗ 10.0 ↖
 9.4 ↑ 10.4 * 10.4 * 9.6 ↘ 10.5 *
 beste Teiler 103.3 (10.) 138.5 (7.) 150.2 (8.)
 Trefferlage 0.58 mm links, 1.15 mm hoch
 Streuwert 1.84, horizontal: 2.03, vertikal: 1.63

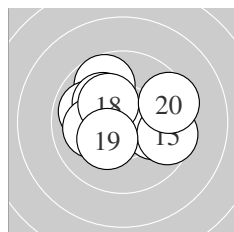

Serie 2:
 10.3 * 9.7 ↘ 10.0 → 9.9 ↖ 9.6 →
 10.1 ↘ 10.1 ← 10.3 * 10.3 * 9.5 →
 beste Teiler 154.5 (11.) 167.7 (19.) 170.2 (18.)
 Trefferlage 0.21 mm links, 0.49 mm hoch
 Streuwert 1.85, horizontal: 2.29, vertikal: 1.26

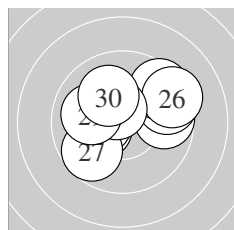

Serie 3:
 9.7 → 9.5 → 10.3 * 9.5 ↗ 10.3 *
 9.3 → 9.7 ↙ 10.5 * 10.0 ↖ 10.1 ↘
 beste Teiler 105.1 (28.) 155.3 (25.) 161.0 (23.)
 Trefferlage 0.35 mm rechts, 0.66 mm hoch
 Streuwert 2.00, horizontal: 2.49, vertikal: 1.35

Unterschrift des Schützen

Ergebnis: **310.7** (296)
 Serien: 102.2 104.1 104.4
 Zähler: 26 4 0 0 0 0 0 0 0 0
 Innenzehner: 20
 weiteste: 361 (6), 296 (15), 282 (28)
 beste Teiler 39.8 (30.) 44.2 (12.) 47.7 (19.)
 Trefferlage 0.08 mm rechts, 0.20 mm tief
 Streuwert 1.24, horizontal: 1.34, vertikal: 1.12

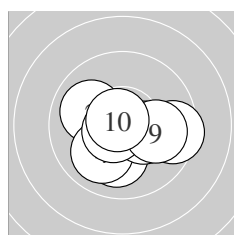
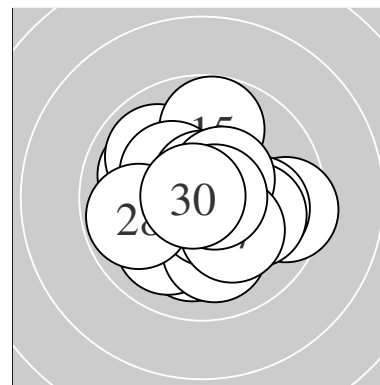

Serie 1:
 10.3 * 10.0 ↖ 10.1 ↓ 10.0 ↙ 10.3 *
 9.5 → 10.7 * 10.6 * 10.0 → 10.7 *
 beste Teiler 51.6 (10.) 52.2 (7.) 78.2 (8.)
 Trefferlage 0.13 mm rechts, 0.64 mm tief
 Streuwert 1.44, horizontal: 1.78, vertikal: 0.99

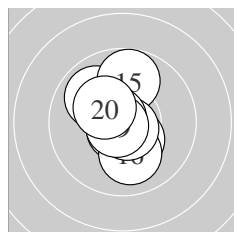

Serie 2:
 9.9 ↘ 10.8 * 10.4 * 10.7 * 9.8 ↑
 10.0 ↓ 10.7 * 10.7 * 10.8 * 10.3 *
 beste Teiler 44.2 (12.) 47.7 (19.) 57.4 (17.)
 Trefferlage 0.28 mm links, 0.14 mm hoch
 Streuwert 1.20, horizontal: 0.84, vertikal: 1.48

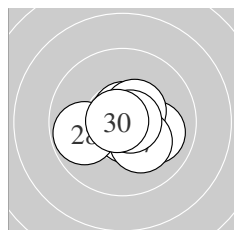

Serie 3:
 10.7 * 10.6 * 10.6 * 10.5 * 10.0 →
 10.5 * 10.2 * 9.8 ← 10.7 * 10.8 *
 beste Teiler 39.8 (30.) 54.1 (29.) 64.3 (21.)
 Trefferlage 0.38 mm rechts, 0.12 mm tief
 Streuwert 1.05, horizontal: 1.30, vertikal: 0.73

Unterschrift des Schützen

Ergebnis: **310.5** (297)
 Serien: 102.0 103.7 104.8
 Zähler: 27 3 0 0 0 0 0 0 0 0
 Innenzehner: 23
 weiteste: 447 (2), 271 (10), 263 (16)
 beste Teiler 32.0 (30.) 43.8 (25.) 56.6 (9.)
 Trefferlage 0.25 mm rechts, 0.28 mm hoch
 Streuwert 1.21, horizontal: 1.47, vertikal: 0.88

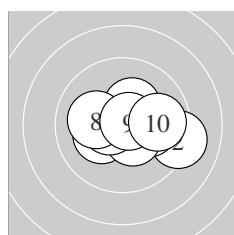
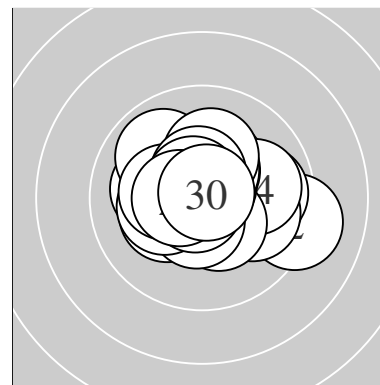

Serie 1:
 10.2 * 9.2 → 10.5 * 10.3 * 10.1 →
 10.5 * 10.5 * 10.1 ← 10.7 * 9.9 →
 beste Teiler 56.6 (9.) 101.2 (7.) 106.9 (3.)
 Trefferlage 0.70 mm rechts, 0.00 mm
 Streuwert 1.50, horizontal: 1.97, vertikal: 0.80

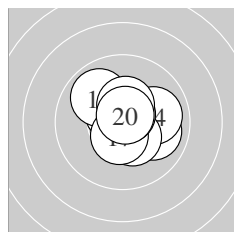

Serie 2:
 10.6 * 10.5 * 10.0 → 10.0 → 10.4 *
 9.9 ↘ 10.5 * 10.7 * 10.4 * 10.7 *
 beste Teiler 57.5 (20.) 69.3 (18.) 98.3 (11.)
 Trefferlage 0.45 mm rechts, 0.24 mm hoch
 Streuwert 1.16, horizontal: 1.28, vertikal: 1.01

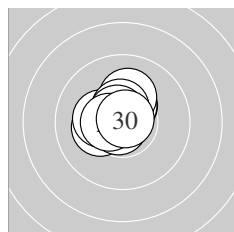

Serie 3:
 10.4 * 10.4 * 10.2 * 10.3 * 10.8 *
 10.2 * 10.5 * 10.7 * 10.5 * 10.8 *
 beste Teiler 32.0 (30.) 43.8 (25.) 75.7 (28.)
 Trefferlage 0.38 mm links, 0.60 mm hoch
 Streuwert 0.80, horizontal: 0.83, vertikal: 0.78

Unterschrift des Schützen

Ergebnis: **314.6** (299)
 Serien: 105.2 105.8 103.6
 Zähler: 29 1 0 0 0 0 0 0 0 0
 Innenzehner: 26
 weiteste: 275 (25), 240 (27), 211 (5)
 beste Teiler 3.1 (29.) 30.3 (19.) 36.4 (11.)
 Trefferlage 0.17 mm links, 0.52 mm hoch
 Streuwert 0.88, horizontal: 0.82, vertikal: 0.94

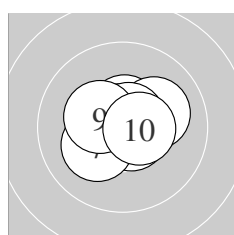
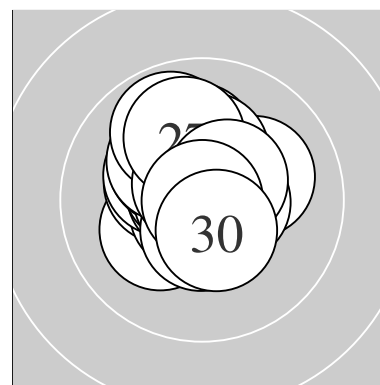

Serie 1:
 10.7 * 10.7 * 10.6 * 10.7 * 10.1 ↗
 10.7 * 10.2 * 10.7 * 10.3 * 10.5 *
 beste Teiler 54.0 (6.) 56.5 (2.) 57.4 (1.)
 Trefferlage 0.15 mm rechts, 0.18 mm hoch
 Streuwert 0.87, horizontal: 1.04, vertikal: 0.66

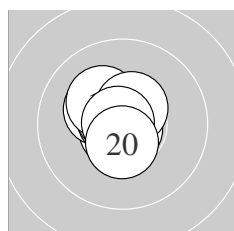

Serie 2:
 10.8 * 10.7 * 10.7 * 10.3 * 10.7 *
 10.6 * 10.2 * 10.5 * 10.8 * 10.5 *
 beste Teiler 30.3 (19.) 36.4 (11.) 59.5 (15.)
 Trefferlage 0.44 mm links, 0.26 mm hoch
 Streuwert 0.68, horizontal: 0.60, vertikal: 0.74

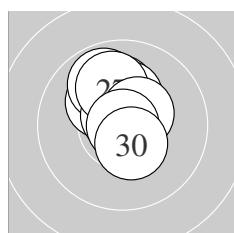

Serie 3:
 10.1 ↑ 10.3 * 10.5 * 10.2 * 9.9 ↘
 10.7 * 10.0 ↘ 10.5 * 10.9 * 10.5 *
 beste Teiler 3.1 (29.) 69.4 (26.) 111.3 (23.)
 Trefferlage 0.24 mm links, 1.12 mm hoch
 Streuwert 0.94, horizontal: 0.70, vertikal: 1.13

Unterschrift des Schützen

Ergebnis: **310.9** (297)
 Serien: 104.1 102.2 104.6
 Zähler: 27 3 0 0 0 0 0 0 0 0
 Innenzehner: 22
 weiteste: 323 (13), 303 (20), 263 (8)
 beste Teiler 44.8 (5.) 48.3 (25.) 61.6 (17.)
 Trefferlage 0.58 mm links, 0.49 mm hoch
 Streuwert 1.07, horizontal: 1.14, vertikal: 0.99

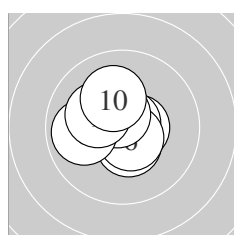
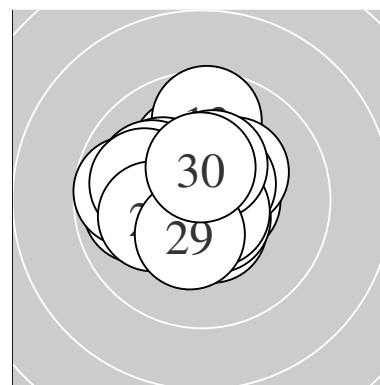

Serie 1:
 10.5 * 10.4 * 10.4 * 10.6 * 10.8 *
 10.6 * 10.6 * 9.9 ← 10.2 * 10.1 ↑
 beste Teiler 44.8 (5.) 90.6 (7.) 92.0 (6.)
 Trefferlage 0.41 mm links, 0.41 mm hoch
 Streuwert 1.03, horizontal: 1.09, vertikal: 0.98

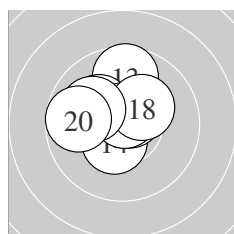

Serie 2:
 10.1 ↖ 10.5 * 9.7 ↑ 10.4 * 10.6 *
 10.2 * 10.7 * 10.3 * 10.0 ↖ 9.7 ←
 beste Teiler 61.6 (17.) 79.0 (15.) 119.2 (12.)
 Trefferlage 0.78 mm links, 0.85 mm hoch
 Streuwert 1.22, horizontal: 1.36, vertikal: 1.07

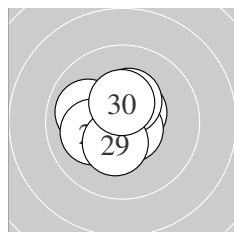

Serie 3:
 10.6 * 10.6 * 10.6 * 10.0 ↖ 10.8 *
 10.1 ← 10.7 * 10.4 * 10.4 * 10.4 *
 beste Teiler 48.3 (25.) 70.7 (27.) 91.7 (21.)
 Trefferlage 0.54 mm links, 0.20 mm hoch
 Streuwert 0.97, horizontal: 1.04, vertikal: 0.89

Unterschrift des Schützen

Meyton Elektronik

Ergebnis: **308.4** (296)
 Serien: 102.8 102.0 103.6
 Zähler: 26 4 0 0 0 0 0 0 0 0
 Innenzehner: 24
 weiteste: 412 (14), 401 (7), 346 (30)
 beste Teiler 50.7 (22.) 68.1 (12.) 68.8 (21.)
 Trefferlage 0.13 mm links, 0.05 mm tief
 Streuwert 1.36, horizontal: 1.43, vertikal: 1.28

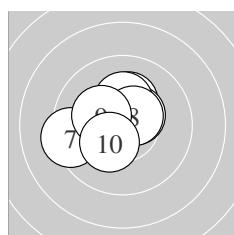
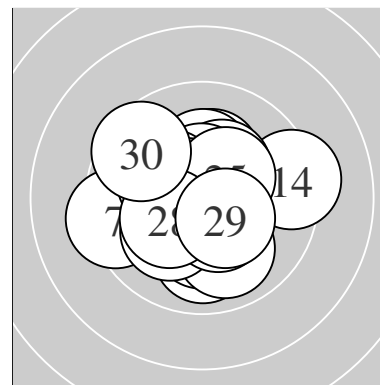

Serie 1:
 10.5 * 10.5 * 10.5 * 10.2 * 10.5 *
 10.2 * 9.3 ← 10.5 * 10.3 * 10.3 *
 beste Teiler 103.0 (2.) 107.0 (8.) 113.3 (1.)
 Trefferlage 0.62 mm links, 0.49 mm hoch
 Streuwert 1.25, horizontal: 1.45, vertikal: 1.02

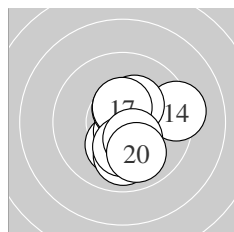

Serie 2:
 10.2 * 10.7 * 9.9 ↓ 9.3 → 10.5 *
 10.3 * 10.5 * 10.2 * 10.4 * 10.0 ↓
 beste Teiler 68.1 (12.) 102.1 (15.) 112.0 (17.)
 Trefferlage 0.61 mm rechts, 0.59 mm tief
 Streuwert 1.42, horizontal: 1.31, vertikal: 1.52

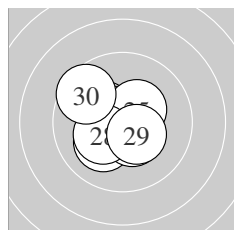

Serie 3:
 10.7 * 10.8 * 10.3 * 10.6 * 10.4 *
 10.1 ↙ 10.4 * 10.3 * 10.4 * 9.6 ↘
 beste Teiler 50.7 (22.) 68.8 (21.) 77.4 (24.)
 Trefferlage 0.38 mm links, 0.06 mm tief
 Streuwert 1.24, horizontal: 1.34, vertikal: 1.13

Unterschrift des Schützen

Meyton Elektronik

Ergebnis: **302.0** (288)
 Serien: 99.0 102.1 100.9
 Zähler: 18 12 0 0 0 0 0 0 0 0
 Innenzehner: 15
 weiteste: 402 (6), 392 (26), 381 (4)
 beste Teiler 34.9 (13.) 54.9 (23.) 86.0 (24.)
 Trefferlage 0.26 mm links, 0.05 mm hoch
 Streuwert 1.75, horizontal: 2.02, vertikal: 1.42

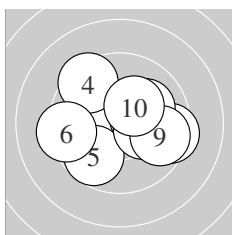
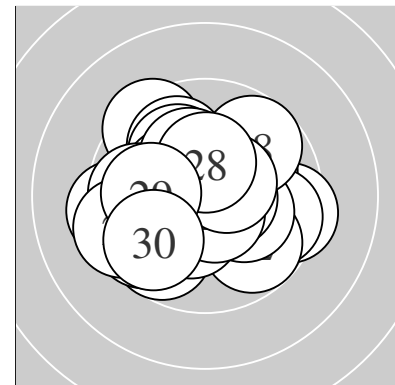

Serie 1:
 10.6 * 10.3 * 9.4 → 9.4 ↖ 9.7 ↙
 9.3 ← 10.2 * 10.1 ↗ 9.7 → 10.3 *
 beste Teiler 92.6 (1.) 154.4 (2.) 167.4 (10.)
 Trefferlage 0.45 mm rechts, 0.14 mm hoch
 Streuwert 2.06, horizontal: 2.50, vertikal: 1.51

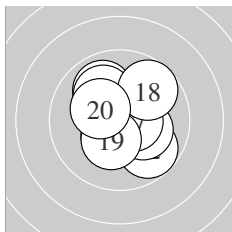

Serie 2:
 9.9 ↖ 9.8 ↘ 10.8 * 10.2 * 10.1 ↖
 10.4 * 10.6 * 9.7 ↗ 10.3 * 10.3 *
 beste Teiler 34.9 (13.) 100.4 (17.) 131.6 (16.)
 Trefferlage 0.14 mm rechts, 0.18 mm hoch
 Streuwert 1.51, horizontal: 1.44, vertikal: 1.57

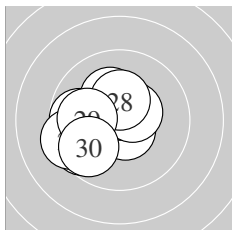

Serie 3:
 9.6 ↙ 9.8 ← 10.7 * 10.6 * 10.2 *
 9.4 ← 10.5 * 10.4 * 10.0 ← 9.7 ↙
 beste Teiler 54.9 (23.) 86.0 (24.) 113.5 (27.)
 Trefferlage 1.38 mm links, 0.17 mm tief
 Streuwert 1.47, horizontal: 1.62, vertikal: 1.31

Unterschrift des Schützen

Ergebnis: **305.6** (290)
 Serien: 103.3 101.4 100.9
 Zähler: 20 10 0 0 0 0 0 0 0 0
 Innenzehner: 17
 weiteste: 392 (14), 350 (30), 324 (13)
 beste Teiler 34.9 (5.) 60.5 (8.) 67.6 (21.)
 Trefferlage 0.05 mm links, 0.14 mm tief
 Streuwert 1.54, horizontal: 1.48, vertikal: 1.59

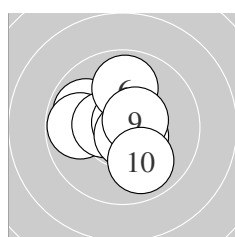
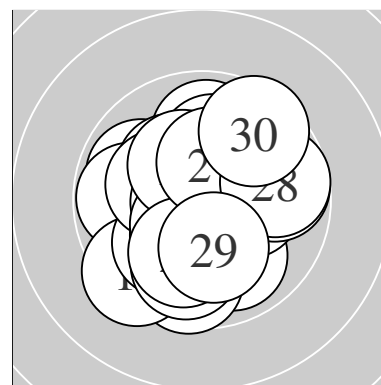

Serie 1:
 9.9 ↖ 9.8 ← 10.5 * 10.7 * 10.8 *
 9.9 ↑ 10.5 * 10.7 * 10.6 * 9.9 ↘
 beste Teiler 34.9 (5.) 60.5 (8.) 73.3 (4.)
 Trefferlage 0.26 mm links, 0.20 mm hoch
 Streuwert 1.35, horizontal: 1.43, vertikal: 1.26

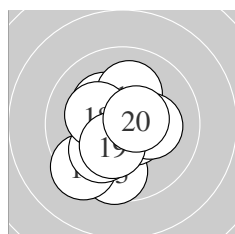

Serie 2:
 10.2 * 10.1 ↑ 9.7 ↓ 9.4 ↙ 10.6 *
 10.1 ↘ 10.2 * 10.2 * 10.3 * 10.6 *
 beste Teiler 90.4 (15.) 98.4 (20.) 159.6 (19.)
 Trefferlage 0.43 mm links, 0.56 mm tief
 Streuwert 1.57, horizontal: 1.39, vertikal: 1.74

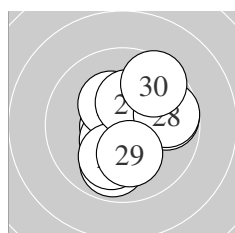

Serie 3:
 10.7 * 10.5 * 9.9 ↓ 10.3 * 10.0 ↙
 9.7 → 10.3 * 9.7 → 10.2 * 9.6 ↗
 beste Teiler 67.6 (21.) 121.4 (22.) 157.8 (27.)
 Trefferlage 0.53 mm rechts, 0.07 mm tief
 Streuwert 1.69, horizontal: 1.57, vertikal: 1.80

Unterschrift des Schützen

Ergebnis: **301.3** (288)
 Serien: 101.3 100.5 99.5
 Zähler: 18 12 0 0 0 0 0 0 0 0
 Innenzehner: 14
 weiteste: 425 (24), 423 (23), 419 (14)
 beste Teiler 33.1 (11.) 44.4 (7.) 45.1 (5.)
 Trefferlage 0.04 mm links, 0.02 mm tief
 Streuwert 1.89, horizontal: 2.10, vertikal: 1.65

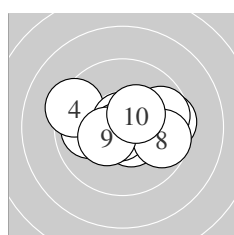
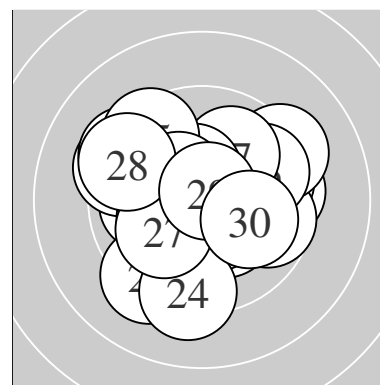

Serie 1:
 9.6 → 9.7 → 10.0 ← 9.4 ↖ 10.8 *
 10.5 * 10.8 * 9.7 → 10.4 * 10.4 *
 beste Teiler 44.4 (7.) 45.1 (5.) 103.7 (6.)
 Trefferlage 0.33 mm rechts, 0.13 mm hoch
 Streuwert 1.79, horizontal: 2.39, vertikal: 0.83

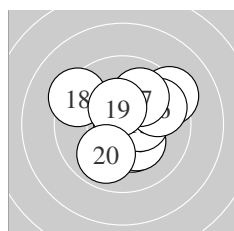

Serie 2:
 10.8 * 10.3 * 10.3 * 9.3 ↗ 10.4 *
 9.8 ↗ 10.0 ↗ 9.3 ↖ 10.4 * 9.9 ↙
 beste Teiler 33.1 (11.) 131.8 (15.) 133.1 (19.)
 Trefferlage 0.56 mm rechts, 0.36 mm hoch
 Streuwert 1.83, horizontal: 2.00, vertikal: 1.65

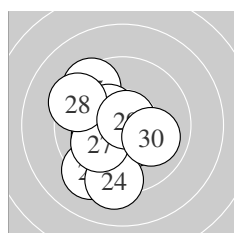

Serie 3:
 10.2 * 10.5 * 9.3 ↙ 9.3 ↓ 9.5 ↖
 10.4 * 10.1 ↙ 9.4 ↖ 10.8 * 10.0 →
 beste Teiler 49.0 (29.) 120.0 (22.) 139.9 (26.)
 Trefferlage 1.03 mm links, 0.58 mm tief
 Streuwert 1.95, horizontal: 1.68, vertikal: 2.19

Unterschrift des Schützen

Ergebnis: **307.2** (294)
 Serien: 102.7 101.0 103.5
 Zähler: 24 6 0 0 0 0 0 0 0 0
 Innenzehner: 20
 weiteste: 425 (14), 359 (18), 336 (24)
 beste Teiler 48.1 (17.) 66.6 (21.) 68.7 (13.)
 Trefferlage 0.35 mm rechts, 0.51 mm tief
 Streuwert 1.40, horizontal: 1.55, vertikal: 1.22

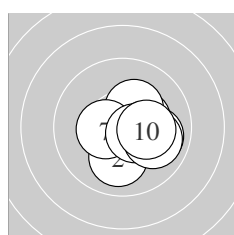
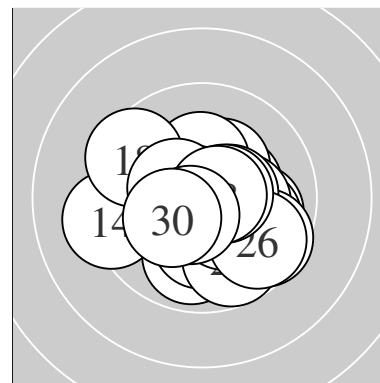

Serie 1:
 10.5 * 10.0 ↓ 10.3 * 10.5 * 10.0 →
 10.3 * 10.4 * 10.5 * 10.0 → 10.2 *
 beste Teiler 105.5 (8.) 113.0 (4.) 121.5 (1.)
 Trefferlage 0.90 mm rechts, 0.40 mm tief
 Streuwert 1.10, horizontal: 1.20, vertikal: 0.99

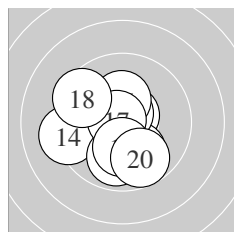

Serie 2:
 10.6 * 10.0 ↘ 10.7 * 9.3 ← 10.3 *
 9.9 ↓ 10.8 * 9.5 ↖ 10.2 * 9.7 ↘
 beste Teiler 48.1 (17.) 68.7 (13.) 76.4 (11.)
 Trefferlage 0.52 mm links, 0.55 mm tief
 Streuwert 1.75, horizontal: 1.75, vertikal: 1.75

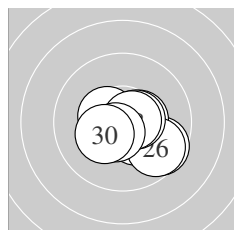

Serie 3:
 10.7 * 10.5 * 10.4 * 9.6 ↘ 10.5 *
 9.7 ↘ 10.5 * 10.7 * 10.6 * 10.3 *
 beste Teiler 66.6 (21.) 72.1 (28.) 94.8 (29.)
 Trefferlage 0.67 mm rechts, 0.59 mm tief
 Streuwert 1.16, horizontal: 1.40, vertikal: 0.85

Unterschrift des Schützen

Ergebnis: **292.4** (280)
 Serien: 98.6 94.8 99.0
 Zähler: 15 10 5 0 0 0 0 0 0 0
 Innenzehner: 11
 weiteste: 640 (6), 634 (12), 592 (14)
 beste Teiler 51.0 (8.) 56.0 (24.) 104.7 (4.)
 Trefferlage 0.48 mm rechts, 0.62 mm tief
 Streuwert 2.44, horizontal: 3.20, vertikal: 1.27

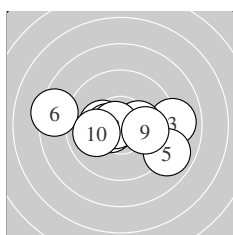
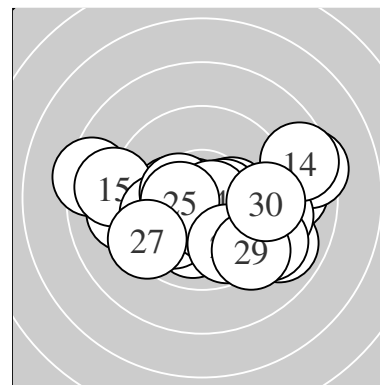

Serie 1:
 10.3 * 10.5 * 9.0 → 10.5 * 8.9 ↘
 8.4 ← 10.3 * 10.7 * 10.0 → 10.0 ←
 beste Teiler 51.0 (8.) 104.7 (4.) 122.4 (2.)
 Trefferlage 0.03 mm rechts, 0.26 mm tief
 Streuwert 2.48, horizontal: 3.38, vertikal: 0.97

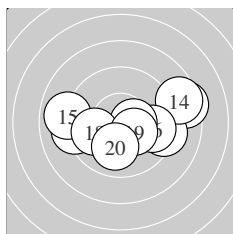

Serie 2:
 9.2 ← 8.4 → 9.3 → 8.6 → 8.9 ←
 9.7 → 10.5 * 9.9 ← 10.3 * 10.0 ↓
 beste Teiler 122.0 (17.) 156.8 (19.) 237.7 (20.)
 Trefferlage 0.89 mm rechts, 0.22 mm tief
 Streuwert 2.95, horizontal: 3.95, vertikal: 1.33

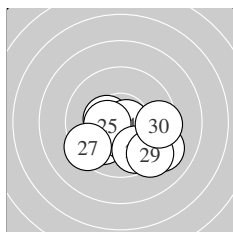

Serie 3:
 10.4 * 10.0 ↙ 10.4 * 10.7 * 10.4 *
 9.1 ↘ 9.4 ↙ 9.8 ↘ 9.3 ↘ 9.5 →
 beste Teiler 56.0 (24.) 127.4 (25.) 135.1 (21.)
 Trefferlage 0.52 mm rechts, 1.38 mm tief
 Streuwert 1.90, horizontal: 2.39, vertikal: 1.23

Unterschrift des Schützen

Meyton Elektronik