

Ergebnis: **204.4** (196)
 Serien: 102.0 102.4
 Zähler: 16 4 0 0 0 0 0 0 0 0
 Innenzehner: 12
 weiteste: 318 (9), 311 (13), 287 (3)
 beste Teiler 61.0 (14.) 67.6 (10.) 96.4 (4.)
 Trefferlage 0.00 mm , 0.30 mm hoch
 Streuwert 1.42, horizontal: 1.61, vertikal: 1.20

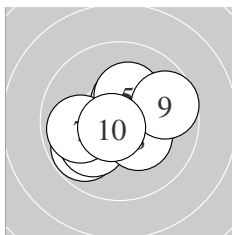

Serie 1:
 10.4 * 10.3 * 9.8 ↙ 10.6 * 10.3 *
 10.0 ↙ 9.9 ← 10.3 * 9.7 → 10.7 *
 beste Teiler 67.6 (10.) 96.4 (4.) 133.4 (1.)
 Trefferlage 0.01 mm rechts, 0.03 mm tief
 Streuwert 1.52, horizontal: 1.80, vertikal: 1.19

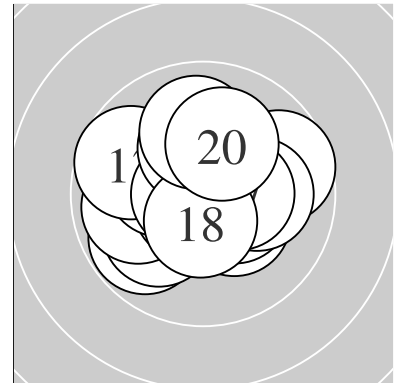
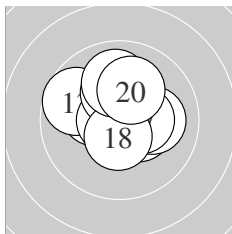

Serie 2:
 10.4 * 10.3 * 9.7 ↖ 10.7 * 10.1 →
 10.2 * 10.4 * 10.5 * 10.0 ↑ 10.1 ↗
 beste Teiler 61.0 (14.) 107.4 (18.) 135.0 (11.)
 Trefferlage 0.03 mm links, 0.64 mm hoch
 Streuwert 1.34, horizontal: 1.49, vertikal: 1.17

Unterschrift des Schützen

Ergebnis: **205.1** (196)
 Serien: 102.5 102.6
 Zähler: 16 4 0 0 0 0 0 0 0 0
 Innenzehner: 14
 weiteste: 343 (15), 306 (3), 275 (6)
 beste Teiler 23.7 (1.) 96.7 (11.) 112.8 (12.)
 Trefferlage 0.27 mm links, 0.42 mm hoch
 Streuwert 1.35, horizontal: 1.45, vertikal: 1.24

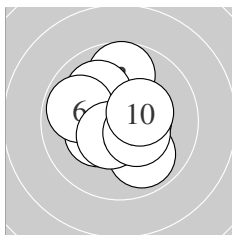
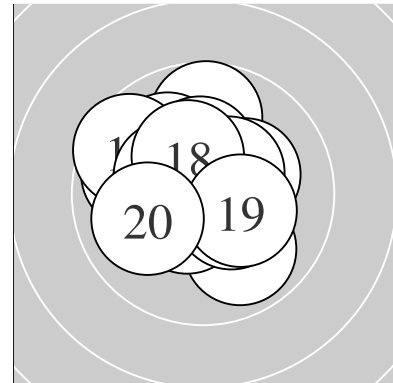

Serie 1:
 10.9 * 10.3 * 9.7 ↑ 10.0 ↘ 10.5 *
 9.9 ↙ 9.9 ↘ 10.5 * 10.4 * 10.4 *
 beste Teiler 23.7 (1.) 113.7 (8.) 121.0 (5.)
 Trefferlage 0.07 mm links, 0.17 mm hoch
 Streuwert 1.46, horizontal: 1.42, vertikal: 1.50

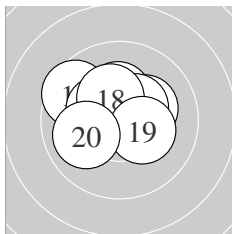

Serie 2:
 10.6 * 10.5 * 10.3 * 10.2 * 9.6 ↘
 10.4 * 10.4 * 10.3 * 10.3 * 10.0 ↙
 beste Teiler 96.7 (11.) 112.8 (12.) 132.0 (16.)
 Trefferlage 0.48 mm links, 0.67 mm hoch
 Streuwert 1.26, horizontal: 1.53, vertikal: 0.91

Unterschrift des Schützen

Ergebnis: **205.0** (197)
 Serien: 102.9 102.1
 Zähler: 17 3 0 0 0 0 0 0 0 0
 Innenzehner: 14
 weiteste: 352 (16), 305 (6), 283 (18)
 beste Teiler 36.1 (10.) 103.0 (1.) 109.0 (14.)
 Trefferlage 0.48 mm links, 0.20 mm hoch
 Streuwert 1.31, horizontal: 1.55, vertikal: 1.02

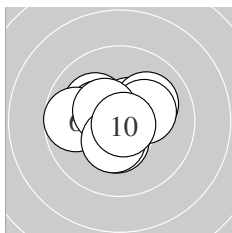
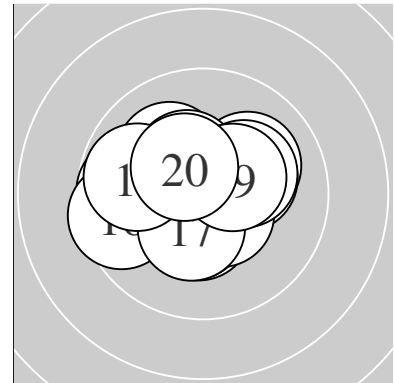

Serie 1:
 10.5 * 10.1 ↖ 10.3 * 10.1 ↗ 10.2 *
 9.7 ← 10.4 * 10.4 * 10.4 * 10.8 *
 beste Teiler 36.1 (10.) 103.0 (1.) 126.8 (8.)
 Trefferlage 0.33 mm links, 0.22 mm hoch
 Streuwert 1.28, horizontal: 1.54, vertikal: 0.94

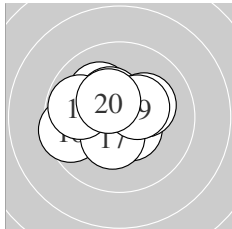

Serie 2:
 10.1 ↖ 10.4 * 10.4 * 10.5 * 10.2 *
 9.5 ← 10.4 * 9.8 ← 10.4 * 10.4 *
 beste Teiler 109.0 (14.) 132.1 (13.) 136.4 (20.)
 Trefferlage 0.62 mm links, 0.18 mm hoch
 Streuwert 1.40, horizontal: 1.62, vertikal: 1.14

Unterschrift des Schützen

Ergebnis: **206.2** (197)
 Serien: 103.1 103.1
 Zähler: 17 3 0 0 0 0 0 0 0 0
 Innenzehner: 14
 weiteste: 294 (2), 282 (13), 261 (5)
 beste Teiler 42.7 (20.) 72.0 (16.) 72.8 (10.)
 Trefferlage 0.19 mm rechts, 0.48 mm tief
 Streuwert 1.23, horizontal: 1.45, vertikal: 0.96

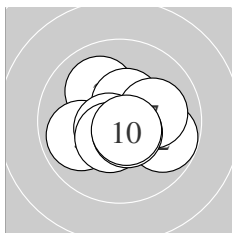
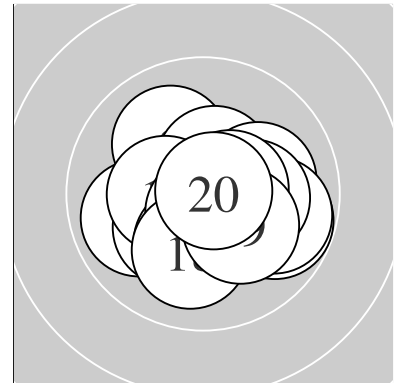

Serie 1:
 10.4 * 9.8 → 10.0 ↖ 10.5 * 9.9 ←
 10.6 * 10.1 → 10.5 * 10.6 * 10.7 *
 beste Teiler 72.8 (10.) 82.3 (6.) 87.9 (9.)
 Trefferlage 0.00 mm , 0.18 mm tief
 Streuwert 1.34, horizontal: 1.59, vertikal: 1.02

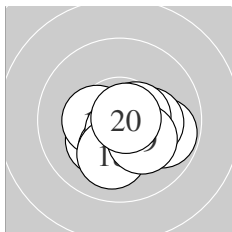

Serie 2:
 10.2 * 10.4 * 9.8 → 10.2 * 10.2 *
 10.7 * 10.5 * 10.1 ↓ 10.2 * 10.8 *
 beste Teiler 42.7 (20.) 72.0 (16.) 105.9 (17.)
 Trefferlage 0.39 mm rechts, 0.79 mm tief
 Streuwert 1.13, horizontal: 1.36, vertikal: 0.84

Unterschrift des Schützen

Ergebnis: **202.1** (192)
 Serien: 100.7 101.4
 Zähler: 12 8 0 0 0 0 0 0 0 0
 Innenzehner: 10
 weiteste: 465 (19), 427 (12), 336 (6)
 beste Teiler 31.3 (13.) 32.1 (11.) 71.5 (17.)
 Trefferlage 0.01 mm rechts, 0.06 mm tief
 Streuwert 1.76, horizontal: 2.27, vertikal: 1.02

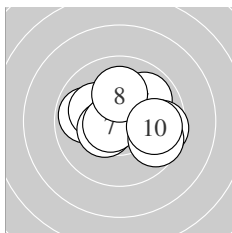
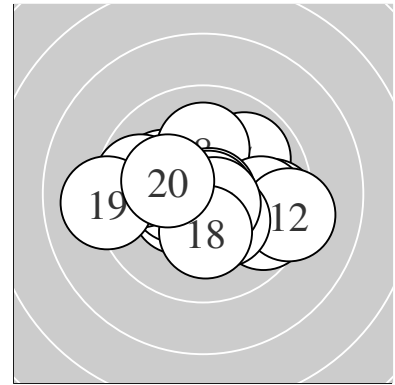

Serie 1:
 9.9 ← 10.1 ↖ 10.4 * 10.6 * 9.9 ↗
 9.6 → 10.6 * 10.1 ↑ 9.7 ↘ 9.8 →
 beste Teiler 77.1 (7.) 92.0 (4.) 136.0 (3.)
 Trefferlage 0.45 mm rechts, 0.28 mm hoch
 Streuwert 1.73, horizontal: 2.16, vertikal: 1.14

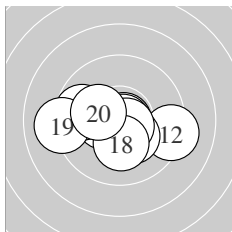

Serie 2:
 10.8 * 9.2 → 10.8 * 10.4 * 10.3 *
 9.7 ← 10.7 * 10.2 * 9.1 ← 10.2 *
 beste Teiler 31.3 (13.) 32.1 (11.) 71.5 (17.)
 Trefferlage 0.42 mm links, 0.40 mm tief
 Streuwert 1.79, horizontal: 2.41, vertikal: 0.79

Unterschrift des Schützen

Ergebnis: **199.4** (191)
 Serien: 98.5 100.9
 Zähler: 11 9 0 0 0 0 0 0 0 0
 Innenzehner: 10
 weiteste: 410 (7), 385 (3), 378 (14)
 beste Teiler 88.6 (1.) 119.4 (6.) 127.5 (12.)
 Trefferlage 0.50 mm links, 0.33 mm tief
 Streuwert 1.87, horizontal: 1.89, vertikal: 1.84

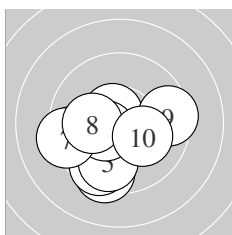
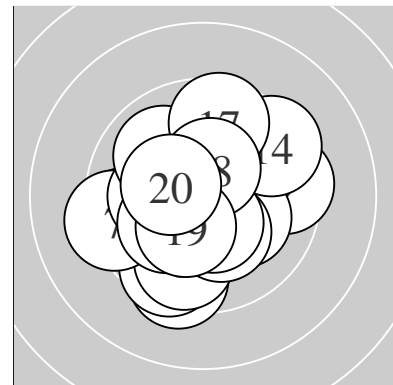

Serie 1:
 10.6 * 9.5 ← 9.4 ↓ 9.6 ↓ 9.8 ↓
 10.5 * 9.3 ← 10.1 ← 9.5 → 10.2 *
 beste Teiler 88.6 (1.) 119.4 (6.) 196.5 (10.)
 Trefferlage 0.91 mm links, 1.20 mm tief
 Streuwert 1.92, horizontal: 2.23, vertikal: 1.54

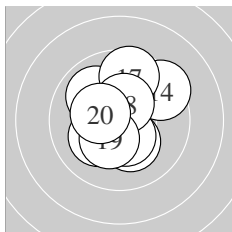

Serie 2:
 10.2 * 10.4 * 10.2 * 9.4 ↗ 10.2 *
 9.9 ↘ 9.6 ↑ 10.4 * 10.3 * 10.3 *
 beste Teiler 127.5 (12.) 128.3 (18.) 152.4 (20.)
 Trefferlage 0.10 mm links, 0.53 mm hoch
 Streuwert 1.63, horizontal: 1.48, vertikal: 1.76

Unterschrift des Schützen

Ergebnis: **207.0** (199)
 Serien: 103.5 103.5
 Zähler: 19 1 0 0 0 0 0 0 0 0
 Innenzehner: 16
 weiteste: 384 (13), 239 (6), 211 (4)
 beste Teiler 74.4 (10.) 90.9 (19.) 93.9 (12.)
 Trefferlage 0.10 mm rechts, 0.04 mm tief
 Streuwert 1.21, horizontal: 1.34, vertikal: 1.08

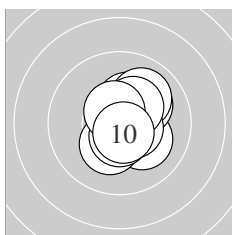
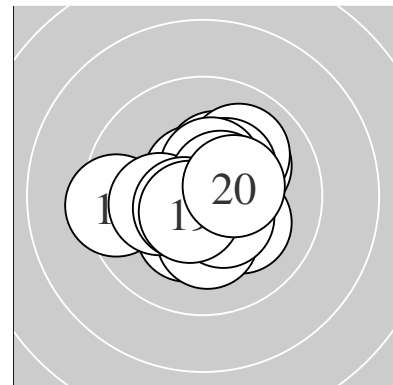

Serie 1:
 10.1 ↘ 10.3 * 10.6 * 10.1 ↗ 10.3 *
 10.0 ↗ 10.5 * 10.3 * 10.6 * 10.7 *
 beste Teiler 74.4 (10.) 94.0 (9.) 95.0 (3.)
 Trefferlage 0.65 mm rechts, 0.19 mm hoch
 Streuwert 1.07, horizontal: 0.85, vertikal: 1.26

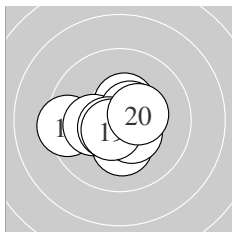

Serie 2:
 10.2 * 10.6 * 9.4 ← 10.4 * 10.5 *
 10.2 * 10.6 * 10.6 * 10.6 * 10.4 *
 beste Teiler 90.9 (19.) 93.9 (12.) 98.8 (17.)
 Trefferlage 0.44 mm links, 0.29 mm tief
 Streuwert 1.25, horizontal: 1.54, vertikal: 0.86

Unterschrift des Schützen

Ergebnis: **201.1** (191)
 Serien: 99.6 101.5
 Zähler: 11 9 0 0 0 0 0 0 0 0
 Innenzehner: 7
 weiteste: 423 (9), 395 (3), 317 (5)
 beste Teiler 49.0 (4.) 62.9 (1.) 84.4 (20.)
 Trefferlage 0.99 mm rechts, 0.22 mm tief
 Streuwert 1.64, horizontal: 1.85, vertikal: 1.40

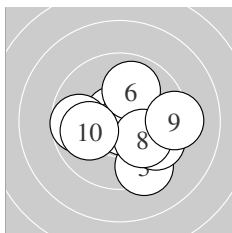
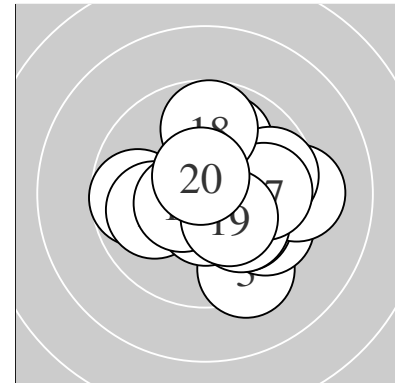

Serie 1:
 10.7 * 10.0 → 9.4 ↘ 10.8 * 9.7 ↘
 9.9 ↑ 9.7 ← 10.1 ↘ 9.3 → 10.0 ←
 beste Teiler 49.0 (4.) 62.9 (1.) 223.0 (8.)
 Trefferlage 0.82 mm rechts, 0.50 mm tief
 Streuwert 1.93, horizontal: 2.28, vertikal: 1.50

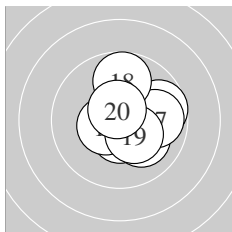

Serie 2:
 10.5 * 10.3 * 10.1 ↘ 9.8 → 10.5 *
 9.7 → 9.9 → 9.8 ↑ 10.3 * 10.6 *
 beste Teiler 84.4 (20.) 107.0 (11.) 113.4 (15.)
 Trefferlage 1.15 mm rechts, 0.05 mm hoch
 Streuwert 1.36, horizontal: 1.40, vertikal: 1.32

Unterschrift des Schützen

Ergebnis: **205.9** (198)
 Serien: 102.4 103.5
 Zähler: 18 2 0 0 0 0 0 0 0 0
 Innenzehner: 15
 weiteste: 257 (20), 252 (7), 242 (2)
 beste Teiler 92.6 (16.) 99.6 (14.) 100.4 (17.)
 Trefferlage 0.39 mm links, 0.41 mm hoch
 Streuwert 1.19, horizontal: 1.30, vertikal: 1.08

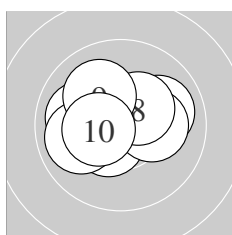
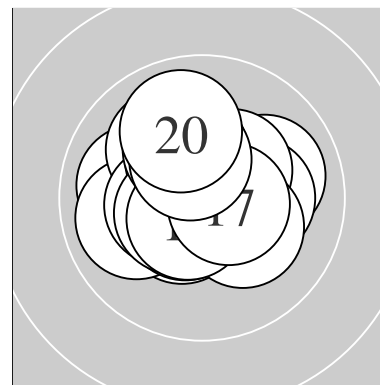

Serie 1:
 10.5 * 10.0 → 10.5 * 10.4 * 10.0 ←
 10.2 * 9.9 ← 10.4 * 10.1 ↗ 10.4 *
 beste Teiler 112.5 (3.) 117.2 (1.) 128.8 (4.)
 Trefferlage 0.52 mm links, 0.27 mm hoch
 Streuwert 1.32, horizontal: 1.68, vertikal: 0.81

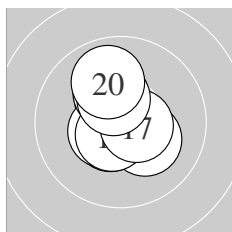

Serie 2:
 10.2 * 10.2 * 10.3 * 10.6 * 10.5 *
 10.6 * 10.6 * 10.2 * 10.4 * 9.9 ↗
 beste Teiler 92.6 (16.) 99.6 (14.) 100.4 (17.)
 Trefferlage 0.27 mm links, 0.54 mm hoch
 Streuwert 1.11, horizontal: 0.82, vertikal: 1.33

Unterschrift des Schützen

Ergebnis: **206.1** (197)
 Serien: 101.9 104.2
 Zähler: 17 3 0 0 0 0 0 0 0 0
 Innenzehner: 14
 weiteste: 315 (8), 306 (1), 295 (9)
 beste Teiler 49.0 (14.) 65.1 (7.) 67.4 (10.)
 Trefferlage 0.56 mm links, 0.17 mm tief
 Streuwert 1.23, horizontal: 1.55, vertikal: 0.80

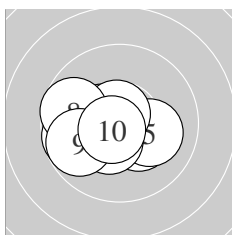
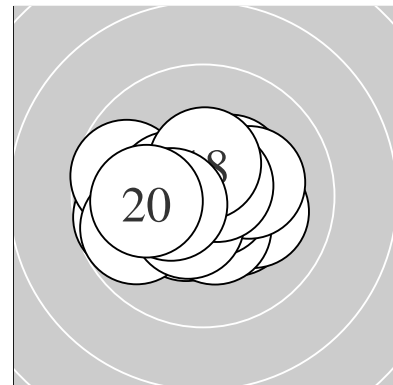

Serie 1:
 9.7 ← 10.3 * 10.0 ← 10.5 * 10.1 →
 10.4 * 10.7 * 9.7 ← 9.8 ← 10.7 *
 beste Teiler 65.1 (7.) 67.4 (10.) 125.0 (4.)
 Trefferlage 1.03 mm links, 0.39 mm tief
 Streuwert 1.34, horizontal: 1.75, vertikal: 0.74

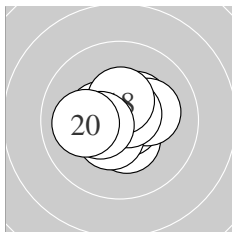

Serie 2:
 10.4 * 10.4 * 10.4 * 10.8 * 10.2 *
 10.5 * 10.7 * 10.4 * 10.4 * 10.0 ←
 beste Teiler 49.0 (14.) 69.4 (17.) 121.8 (16.)
 Trefferlage 0.09 mm links, 0.05 mm hoch
 Streuwert 1.06, horizontal: 1.24, vertikal: 0.83

Unterschrift des Schützen

Ergebnis: **205.8** (198)
 Serien: 103.1 102.7
 Zähler: 18 2 0 0 0 0 0 0 0 0
 Innenzehner: 13
 weiteste: 422 (10), 300 (20), 247 (2)
 beste Teiler 44.2 (5.) 63.2 (11.) 81.5 (9.)
 Trefferlage 0.31 mm links, 0.06 mm tief
 Streuwert 1.35, horizontal: 1.54, vertikal: 1.12

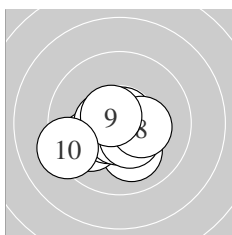
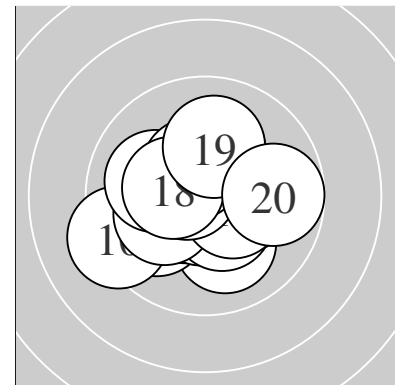

Serie 1:
 10.1 ↘ 10.0 ↙ 10.5 * 10.5 * 10.8 *
 10.6 * 10.4 * 10.3 * 10.6 * 9.3 ↙
 beste Teiler 44.2 (5.) 81.5 (9.) 82.5 (6.)
 Trefferlage 0.52 mm links, 0.70 mm tief
 Streuwert 1.28, horizontal: 1.58, vertikal: 0.87

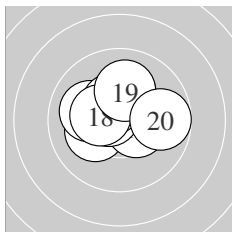

Serie 2:
 10.7 * 10.2 * 10.4 * 10.6 * 10.1 ↑
 10.0 ↙ 10.4 * 10.4 * 10.1 ↑ 9.8 →
 beste Teiler 63.2 (11.) 85.2 (14.) 130.6 (17.)
 Trefferlage 0.11 mm links, 0.58 mm hoch
 Streuwert 1.30, horizontal: 1.55, vertikal: 0.97

Unterschrift des Schützen

Ergebnis: **205.4** (195)
 Serien: 102.5 102.9
 Zähler: 15 5 0 0 0 0 0 0 0 0
 Innenzehner: 14
 weiteste: 334 (8), 328 (20), 286 (2)
 beste Teiler 62.3 (14.) 64.0 (13.) 71.0 (1.)
 Trefferlage 0.34 mm rechts, 0.41 mm hoch
 Streuwert 1.32, horizontal: 1.43, vertikal: 1.20

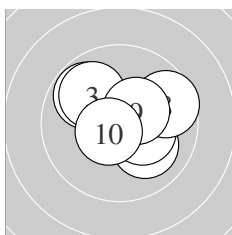
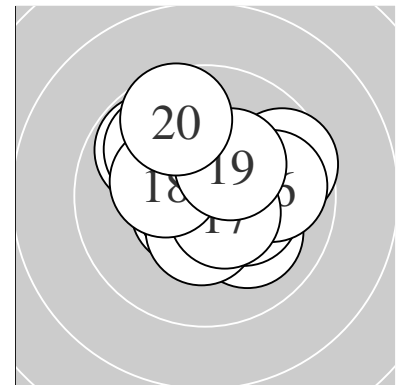

Serie 1:
 10.7 * 9.8 ↘ 9.9 ↘ 10.5 * 10.6 *
 10.1 ↘ 10.3 * 9.6 → 10.4 * 10.6 *
 beste Teiler 71.0 (1.) 92.0 (10.) 99.2 (5.)
 Trefferlage 0.52 mm rechts, 0.31 mm hoch
 Streuwert 1.40, horizontal: 1.64, vertikal: 1.12

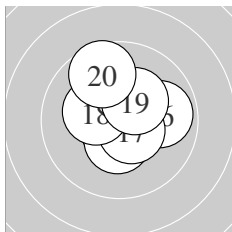

Serie 2:
 10.2 * 10.3 * 10.7 * 10.7 * 10.4 *
 9.9 → 10.5 * 10.3 * 10.3 * 9.6 ↖
 beste Teiler 62.3 (14.) 64.0 (13.) 103.5 (17.)
 Trefferlage 0.17 mm rechts, 0.51 mm hoch
 Streuwert 1.29, horizontal: 1.25, vertikal: 1.33

Unterschrift des Schützen

Ergebnis: **206.1** (195)
 Serien: 103.2 102.9
 Zähler: 15 5 0 0 0 0 0 0 0 0
 Innenzehner: 14
 weiteste: 308 (10), 280 (1), 265 (15)
 beste Teiler 17.0 (4.) 85.7 (6.) 87.3 (9.)
 Trefferlage 0.08 mm links, 0.27 mm hoch
 Streuwert 1.28, horizontal: 1.39, vertikal: 1.16

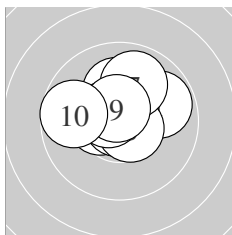
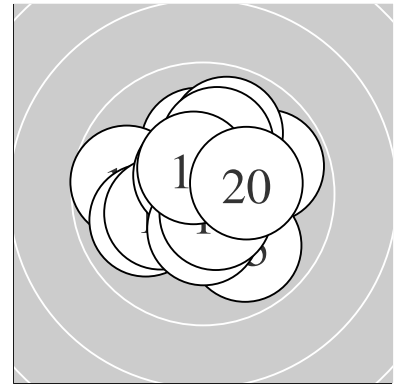

Serie 1:
 9.8 → 10.5 * 10.4 * 10.9 * 10.2 *
 10.6 * 9.9 ↑ 10.6 * 10.6 * 9.7 ←
 beste Teiler 17.0 (4.) 85.7 (6.) 87.3 (9.)
 Trefferlage 0.24 mm links, 0.70 mm hoch
 Streuwert 1.24, horizontal: 1.49, vertikal: 0.92

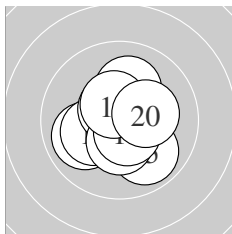

Serie 2:
 9.9 ← 10.2 * 10.6 * 10.5 * 9.9 ↘
 10.4 * 10.6 * 10.1 ↑ 10.5 * 10.2 *
 beste Teiler 91.6 (13.) 94.0 (17.) 110.7 (19.)
 Trefferlage 0.07 mm rechts, 0.15 mm tief
 Streuwert 1.30, horizontal: 1.34, vertikal: 1.26

Unterschrift des Schützen

Ergebnis: **206.9** (199)
 Serien: 103.7 103.2
 Zähler: 19 1 0 0 0 0 0 0 0 0
 Innenzehner: 14
 weiteste: 347 (15), 243 (12), 231 (8)
 beste Teiler 38.3 (11.) 45.8 (1.) 66.2 (16.)
 Trefferlage 0.04 mm links, 0.23 mm hoch
 Streuwert 1.23, horizontal: 1.41, vertikal: 1.03

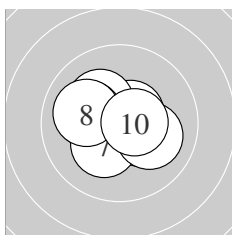
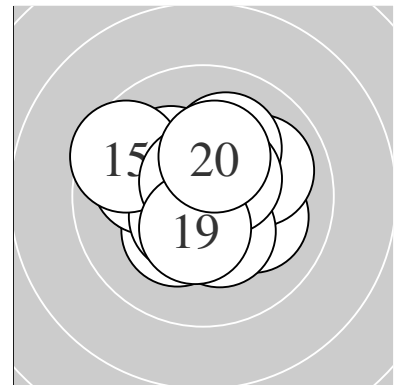

Serie 1:
 10.8 * 10.7 * 10.6 * 10.2 * 10.1 ↖
 10.3 * 10.3 * 10.0 ↖ 10.1 ↗ 10.6 *
 beste Teiler 45.8 (1.) 71.1 (2.) 96.5 (3.)
 Trefferlage 0.16 mm links, 0.04 mm hoch
 Streuwert 1.20, horizontal: 1.48, vertikal: 0.83

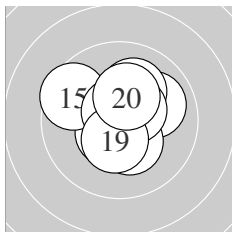

Serie 2:
 10.8 * 10.0 ↗ 10.5 * 10.1 ↗ 9.6 ↖
 10.7 * 10.3 * 10.5 * 10.4 * 10.3 *
 beste Teiler 38.3 (11.) 66.2 (16.) 110.5 (13.)
 Trefferlage 0.07 mm rechts, 0.42 mm hoch
 Streuwert 1.31, horizontal: 1.39, vertikal: 1.21

Unterschrift des Schützen

Ergebnis: **204.2** (196)
 Serien: 103.4 100.8
 Zähler: 17 2 1 0 0 0 0 0 0 0
 Innenzehner: 14
 weiteste: 574 (11), 419 (6), 341 (15)
 beste Teiler 67.8 (3.) 76.9 (20.) 81.2 (2.)
 Trefferlage 0.71 mm rechts, 0.35 mm tief
 Streuwert 1.52, horizontal: 1.78, vertikal: 1.21

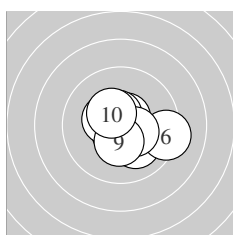
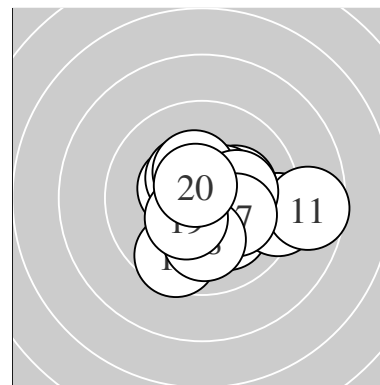

Serie 1:
 10.5 * 10.6 * 10.7 * 10.4 * 10.1 ↘
 9.3 → 10.6 * 10.4 * 10.4 * 10.4 *
 beste Teiler 67.8 (3.) 81.2 (2.) 97.0 (7.)
 Trefferlage 0.50 mm rechts, 0.28 mm tief
 Streuwert 1.29, horizontal: 1.53, vertikal: 1.00

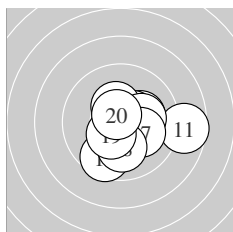

Serie 2:
 8.7 → 10.2 * 10.5 * 10.4 * 9.6 ↙
 10.2 * 10.1 ↘ 10.1 ↓ 10.4 * 10.6 *
 beste Teiler 76.9 (20.) 122.2 (13.) 137.4 (19.)
 Trefferlage 0.93 mm rechts, 0.42 mm tief
 Streuwert 1.77, horizontal: 2.06, vertikal: 1.43

Unterschrift des Schützen

Ergebnis: **202.1** (191)
 Serien: 99.8 102.3
 Zähler: 11 9 0 0 0 0 0 0 0 0
 Innenzehner: 9
 weiteste: 466 (9), 382 (15), 339 (6)
 beste Teiler 61.0 (1.) 73.6 (4.) 79.2 (16.)
 Trefferlage 0.51 mm rechts, 0.49 mm tief
 Streuwert 1.68, horizontal: 1.57, vertikal: 1.79

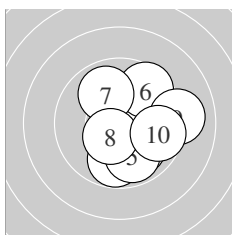
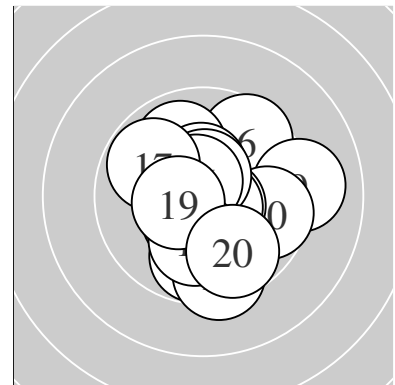

Serie 1:
 10.7 * 10.0 ↘ 9.8 ↓ 10.7 * 9.9 ↓
 9.6 ↗ 9.9 ↖ 10.4 * 9.1 → 9.7 →
 beste Teiler 61.0 (1.) 73.6 (4.) 129.5 (8.)
 Trefferlage 1.09 mm rechts, 0.44 mm tief
 Streuwert 1.84, horizontal: 1.80, vertikal: 1.88

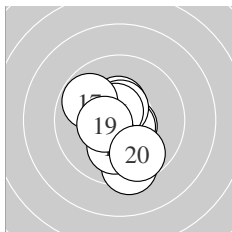

Serie 2:
 10.6 * 10.6 * 10.4 * 10.6 * 9.4 ↓
 10.6 * 9.8 ↖ 10.1 ↓ 10.5 * 9.7 ↓
 beste Teiler 79.2 (16.) 84.3 (12.) 91.0 (11.)
 Trefferlage 0.07 mm links, 0.53 mm tief
 Streuwert 1.49, horizontal: 1.11, vertikal: 1.79

Unterschrift des Schützen